

[MS-XLS]:

Excel Binary File Format (.xls) Structure

Intellectual Property Rights Notice for Open Specifications Documentation

- **Technical Documentation.** Microsoft publishes Open Specifications documentation (“this documentation”) for protocols, file formats, data portability, computer languages, and standards support. Additionally, overview documents cover inter-protocol relationships and interactions.
- **Copyrights.** This documentation is covered by Microsoft copyrights. Regardless of any other terms that are contained in the terms of use for the Microsoft website that hosts this documentation, you can make copies of it in order to develop implementations of the technologies that are described in this documentation and can distribute portions of it in your implementations that use these technologies or in your documentation as necessary to properly document the implementation. You can also distribute in your implementation, with or without modification, any schemas, IDLs, or code samples that are included in the documentation. This permission also applies to any documents that are referenced in the Open Specifications documentation.
- **No Trade Secrets.** Microsoft does not claim any trade secret rights in this documentation.
- **Patents.** Microsoft has patents that might cover your implementations of the technologies described in the Open Specifications documentation. Neither this notice nor Microsoft's delivery of this documentation grants any licenses under those patents or any other Microsoft patents. However, a given Open Specifications document might be covered by the Microsoft [Open Specifications Promise](#) or the [Microsoft Community Promise](#). If you would prefer a written license, or if the technologies described in this documentation are not covered by the Open Specifications Promise or Community Promise, as applicable, patent licenses are available by contacting iplg@microsoft.com.
- **License Programs.** To see all of the protocols in scope under a specific license program and the associated patents, visit the [Patent Map](#).
- **Trademarks.** The names of companies and products contained in this documentation might be covered by trademarks or similar intellectual property rights. This notice does not grant any licenses under those rights. For a list of Microsoft trademarks, visit www.microsoft.com/trademarks.
- **Fictitious Names.** The example companies, organizations, products, domain names, email addresses, logos, people, places, and events that are depicted in this documentation are fictitious. No association with any real company, organization, product, domain name, email address, logo, person, place, or event is intended or should be inferred.

Reservation of Rights. All other rights are reserved, and this notice does not grant any rights other than as specifically described above, whether by implication, estoppel, or otherwise.

Tools. The Open Specifications documentation does not require the use of Microsoft programming tools or programming environments in order for you to develop an implementation. If you have access to Microsoft programming tools and environments, you are free to take advantage of them. Certain Open Specifications documents are intended for use in conjunction with publicly available standards specifications and network programming art and, as such, assume that the reader either is familiar with the aforementioned material or has immediate access to it.

Support. For questions and support, please contact dochelp@microsoft.com.

Revision Summary

Date	Revision History	Revision Class	Comments
6/27/2008	1.0	New	First release
8/15/2008	1.01	Minor	Revised and edited the technical content
10/6/2008	1.02	Minor	Revised and edited the technical content
1/16/2009	1.03	Minor	Updated the Intellectual Property Rights Notice
7/13/2009	1.04	Major	Changes made for template compliance
8/28/2009	1.05	Editorial	Revised and edited the technical content
11/6/2009	1.06	Editorial	Revised and edited the technical content
2/19/2010	2.0	Major	Updated and revised the technical content
3/31/2010	2.01	Editorial	Revised and edited the technical content
4/30/2010	2.02	Editorial	Revised and edited the technical content
6/7/2010	2.03	Minor	Updated the technical content
6/29/2010	2.04	Editorial	Changed language and formatting in the technical content.
7/23/2010	2.04	None	No changes to the meaning, language, or formatting of the technical content.
9/27/2010	2.05	Minor	Clarified the meaning of the technical content.
11/15/2010	2.05	None	No changes to the meaning, language, or formatting of the technical content.
12/17/2010	2.05	None	No changes to the meaning, language, or formatting of the technical content.
3/18/2011	2.05	None	No changes to the meaning, language, or formatting of the technical content.
6/10/2011	2.05	None	No changes to the meaning, language, or formatting of the technical content.
1/20/2012	2.6	Minor	Clarified the meaning of the technical content.
4/11/2012	2.6	None	No changes to the meaning, language, or formatting of the technical content.
7/16/2012	2.6	None	No changes to the meaning, language, or formatting of the technical content.
10/8/2012	2.7	Minor	Clarified the meaning of the technical content.
2/11/2013	2.7	None	No changes to the meaning, language, or formatting of the technical content.
7/30/2013	2.8	Minor	Clarified the meaning of the technical content.
11/18/2013	2.8	None	No changes to the meaning, language, or formatting of the technical content.
2/10/2014	2.8	None	No changes to the meaning, language, or formatting of the

Date	Revision History	Revision Class	Comments
			technical content.
4/30/2014	3.0	Major	Significantly changed the technical content.
7/31/2014	3.1	Minor	Clarified the meaning of the technical content.
10/30/2014	3.2	Minor	Clarified the meaning of the technical content.
3/16/2015	4.0	Major	Significantly changed the technical content.
9/4/2015	4.1	Minor	Clarified the meaning of the technical content.
7/15/2016	4.2	Minor	Clarified the meaning of the technical content.
8/23/2016	4.2	None	No changes to the meaning, language, or formatting of the technical content.
9/14/2016	4.2	None	No changes to the meaning, language, or formatting of the technical content.
10/17/2016	5.0	Major	Significantly changed the technical content.
6/20/2017	6.0	Major	Significantly changed the technical content.
9/19/2017	6.1	Minor	Clarified the meaning of the technical content.
12/12/2017	6.1	None	No changes to the meaning, language, or formatting of the technical content.
4/27/2018	7.0	Major	Significantly changed the technical content.
8/28/2018	8.0	Major	Significantly changed the technical content.
12/11/2018	8.0	None	No changes to the meaning, language, or formatting of the technical content.
3/19/2019	8.0	None	No changes to the meaning, language, or formatting of the technical content.
6/18/2019	8.0	None	No changes to the meaning, language, or formatting of the technical content.
4/22/2021	9.0	Major	Significantly changed the technical content.
8/17/2021	10.0	Major	Significantly changed the technical content.
11/16/2021	10.1	Minor	Clarified the meaning of the technical content.
2/15/2022	10.2	Minor	Clarified the meaning of the technical content.
5/17/2022	10.3	Minor	Clarified the meaning of the technical content.
8/16/2022	10.4	Minor	Clarified the meaning of the technical content.
11/15/2022	10.5	Minor	Clarified the meaning of the technical content.

Table of Contents

1	Introduction	28
1.1	Glossary	28
1.2	References	51
1.2.1	Normative References	51
1.2.2	Informative References	52
1.3	Overview	53
1.3.1	stream Byte Ordering	53
1.3.2	Organization of This Documentation	53
1.4	Relationship to Protocols and Other Structures	54
1.5	Applicability Statement	54
1.6	Versioning and Localization	54
1.7	Vendor-Extensible Fields	55
2	Structures	56
2.1	File Structure.....	56
2.1.1	Compound File	56
2.1.2	Stream.....	56
2.1.3	Substream.....	56
2.1.4	Record	56
2.1.5	Collection of Records.....	57
2.1.6	Future Record	57
2.1.6.1	Chart.....	58
2.1.6.2	PivotTable.....	58
2.1.7	Storages and Streams.....	58
2.1.7.1	Component Object Stream (\001CompObj)	58
2.1.7.2	Control Stream (Cntls)	59
2.1.7.3	Data Spaces Storage (\006DataSpaces).....	59
2.1.7.4	Document Summary Information Stream (\005DocumentSummaryInformation)	59
2.1.7.5	Embedding Storage (MBD...)	59
2.1.7.6	Encryption Stream (encryption)	59
2.1.7.7	Link Storage (LNK...).....	59
2.1.7.8	List Data Stream (List Data)	60
2.1.7.8.1	Attributes	61
2.1.7.8.2	Elements.....	61
2.1.7.8.2.1	LISTNAME	62
2.1.7.8.2.2	VIEWGUID	62
2.1.7.8.2.3	LISTWEB	62
2.1.7.8.2.4	ROOTFOLDER	62
2.1.7.8.2.5	LISTSCHEMA	62
2.1.7.8.2.6	VIEWSCHEMA.....	63
2.1.7.8.2.7	LISTDATA	63
2.1.7.8.2.8	UPDATE	63
2.1.7.8.2.9	LISTDATAFTR	64
2.1.7.9	Office Data Store Storage (MsoDataStore)	64
2.1.7.10	Office Toolbars Stream (XCB)	64
2.1.7.11	OLE Stream (\001Ole).....	65
2.1.7.12	Pivot Cache Storage (_SX_DB_CUR).....	65
2.1.7.13	Protected Content Stream (\009DRMContent)	65
2.1.7.14	Revision Stream (Revision Log)	65
2.1.7.15	Signatures Stream (_signatures)	66
2.1.7.16	Summary Information Stream (\005SummaryInformation)	66
2.1.7.17	User Names Stream (User Names).....	67
2.1.7.18	VBA Storage (_VBA_PROJECT_CUR).....	67
2.1.7.19	Viewer Content Stream (\009DRMViewerContent).....	67

2.1.7.20	Workbook Stream (Workbook)	67
2.1.7.20.1	Chart Sheet Substream	67
2.1.7.20.2	Dialog Sheet Substream	69
2.1.7.20.3	Globals Substream	69
2.1.7.20.4	Macro Sheet Substream	71
2.1.7.20.5	Worksheet Substream	71
2.1.7.20.6	Common Productions	73
2.1.7.21	XML Signatures Storage (_xmlsignatures)	75
2.1.7.22	XML Stream (XML)	75
2.1.7.22.1	Elements	76
2.1.7.22.1.1	MapInfo	77
2.1.7.22.1.2	Schema	77
2.1.7.22.1.3	Map	77
2.1.7.22.1.4	DataBinding	78
2.1.7.22.2	Simple Types	78
2.1.7.22.2.1	ST_DataBindingLoadMode	78
2.1.7.22.2.2	ST_XmlMapBoolean	79
2.1.7.22.2.3	ST_XmlMapId	79
2.1.7.22.2.4	ST_XmlString65535	79
2.1.7.22.2.5	ST_XmlString256	79
2.2	Conceptual Overview	79
2.2.1	Cell Table	79
2.2.1.1	Retrieval of Last-Calculated Cell Values Without Loading Cell Table	80
2.2.2	Formulas	80
2.2.2.1	Operator Tokens	81
2.2.2.2	Operand Tokens	81
2.2.2.2.1	Value Class	81
2.2.2.2.2	Reference Class	82
2.2.2.3	Control Tokens	82
2.2.2.4	Display Tokens	82
2.2.2.5	Mem Tokens	82
2.2.2.6	Formula Elements	82
2.2.3	Charts	82
2.2.3.1	Chart Sheet	83
2.2.3.2	Chart Data Cache	84
2.2.3.3	Chart	85
2.2.3.4	Pivot Chart	86
2.2.3.5	Axis Group	86
2.2.3.6	Axis	88
2.2.3.7	Chart Group	90
2.2.3.8	Legend	91
2.2.3.9	Series	93
2.2.3.10	Data Point	94
2.2.3.11	Data Label	94
2.2.3.12	Trendline	100
2.2.3.13	Error Bar	100
2.2.3.14	Data Table	101
2.2.3.15	Attached Label	102
2.2.3.16	SPRC	103
2.2.3.17	Chart Area	103
2.2.4	Metadata	103
2.2.4.1	Metadata Types	104
2.2.4.2	Cell Metadata	104
2.2.4.3	Value Metadata	104
2.2.4.4	Metadata Block	105
2.2.4.5	MDX Metadata	105
2.2.4.5.1	MDX Tuple Metadata	106
2.2.4.5.2	MDX Set Metadata	106

2.2.4.5.3	MDX Member Property Metadata	106
2.2.4.5.4	MDX KPI Metadata.....	106
2.2.5	PivotTables	106
2.2.5.1	PivotTable Records.....	107
2.2.5.1.1	Usage of SXAddl Records.....	107
2.2.5.1.1.1	Class	107
2.2.5.1.1.1.1	SxcView Class	108
2.2.5.1.1.1.2	SxcField Class	109
2.2.5.1.1.1.3	SxcHierarchy Class	109
2.2.5.1.1.1.4	SxcCache Class	110
2.2.5.1.1.1.5	SxcCacheField Class.....	111
2.2.5.1.1.1.6	SxcQsi Class	111
2.2.5.1.1.1.7	SxcQuery Class	112
2.2.5.1.1.1.8	SxcGrpLevel Class	112
2.2.5.1.1.1.9	SxcGroup Class	112
2.2.5.1.1.1.10	SxcCacheItem Class	113
2.2.5.1.1.1.11	SxcSXrule Class	113
2.2.5.1.1.1.12	SxcSXfilt Class	114
2.2.5.1.1.1.13	SxcSXDH Class	114
2.2.5.1.1.1.14	SxcAutoSort Class	114
2.2.5.1.1.1.15	SxcSXMgs Class	115
2.2.5.1.1.1.16	SxcSXMg Class.....	115
2.2.5.1.1.1.17	SxcField12 Class	115
2.2.5.1.1.1.18	SxcSXCondFmts Class.....	116
2.2.5.1.1.1.19	SxcSXCondFmt Class	116
2.2.5.1.1.1.20	SxcSXFilters12 Class.....	116
2.2.5.1.1.1.21	SxcSXFilter12 Class	117
2.2.5.2	Data Functionality Level.....	117
2.2.5.3	PivotCache	117
2.2.5.3.1	PivotCache Functionality Level	118
2.2.5.3.2	Source Data.....	118
2.2.5.3.2.1	Multiple Consolidation Ranges	119
2.2.5.3.3	Associated PivotTable views.....	121
2.2.5.3.4	OLAP PivotCache	121
2.2.5.3.4.1	OLAP Data Model	121
2.2.5.3.5	Cache Fields	122
2.2.5.3.6	Cache Items	123
2.2.5.3.7	Grouping	125
2.2.5.3.8	Calculated Fields	131
2.2.5.3.9	Calculated Items	132
2.2.5.3.10	OLAP Grouping.....	132
2.2.5.3.11	OLAP Calculated Members	132
2.2.5.3.12	Cache Records	133
2.2.5.4	PivotTable View	134
2.2.5.4.1	Associated PivotCache.....	134
2.2.5.4.2	OLAP PivotTable view.....	134
2.2.5.4.3	Pivot Fields	134
2.2.5.4.3.1	Pivot Field Sorting.....	135
2.2.5.4.4	Pivot Items.....	136
2.2.5.4.5	Pivot Hierarchies	136
2.2.5.4.5.1	Association of Pivot Hierarchies and Pivot Fields and Cache Fields ...	137
2.2.5.4.5.2	Measures	138
2.2.5.4.5.3	KPIs	138
2.2.5.4.5.4	Named Sets	138
2.2.5.4.6	Member Properties	138
2.2.5.4.7	Manual Filters	139
2.2.5.4.7.1	Non-OLAP Manual Filters.....	139
2.2.5.4.7.2	OLAP Manual Filters	139

2.2.5.4.8	Filtering by Criteria	140
2.2.5.4.8.1	Advanced Filters	140
2.2.5.4.8.1.1	Label Filters	141
2.2.5.4.8.1.2	Date Filters	141
2.2.5.4.8.1.3	Value Filters	142
2.2.5.4.8.2	Simple Filters	142
2.2.5.4.9	PivotTable Axes	142
2.2.5.4.9.1	Page Axis	142
2.2.5.4.9.1.1	Non-OLAP Page Filtering	143
2.2.5.4.9.1.2	OLAP Page Filtering	143
2.2.5.4.9.2	Row Axis	144
2.2.5.4.9.3	Column Axis	145
2.2.5.4.9.4	Nesting	145
2.2.5.4.9.4.1	Collapsing	146
2.2.5.4.9.4.2	Subtotalling	147
2.2.5.4.9.5	Data Axis	149
2.2.5.4.9.5.1	Data Items	149
2.2.5.4.9.5.2	Data Field	149
2.2.5.4.10	PivotTable Layout	149
2.2.5.4.10.1	Location and Body	150
2.2.5.4.10.1.1	Row Area	152
2.2.5.4.10.1.2	Column Area	153
2.2.5.4.10.1.3	Page Area	153
2.2.5.4.10.1.4	Data Area	154
2.2.5.4.10.2	Truncation	154
2.2.5.4.10.3	Pivot Lines	154
2.2.5.4.10.4	Pivot Line Entries	155
2.2.5.4.11	PivotTable Rules	156
2.2.6	Styles	157
2.2.6.1	XFs	157
2.2.6.1.1	Cell XFs	157
2.2.6.1.2	Cell Styles	157
2.2.6.1.2.1	Cell Style XFs	158
2.2.6.1.2.2	Normal Style	158
2.2.6.2	Differential Formatting (DXFs)	158
2.2.6.2.1	Conditional Formatting	158
2.2.6.2.2	Table Style Elements	159
2.2.6.2.3	Table Block-Level Formatting	159
2.2.6.2.4	PivotTable Areas	159
2.2.6.2.5	Sorting and Filtering	159
2.2.6.3	Table Styles	159
2.2.6.4	Format Conflicts	159
2.2.7	External References	160
2.2.7.1	External Reference Consumers	160
2.2.7.2	Supporting Link	160
2.2.7.3	External Workbook	161
2.2.7.4	External Defined Name	161
2.2.7.5	External Cell Cache	161
2.2.7.6	DDE Data Source	161
2.2.7.7	DDE Data Item	161
2.2.7.8	OLE Data Source	161
2.2.7.9	OLE Data Item	161
2.2.8	External Connections	162
2.2.8.1	Connection Name	162
2.2.8.2	External Connection Files	162
2.2.8.3	OLE DB Connections	162
2.2.8.3.1	OLAP Connections	162
2.2.8.4	ODBC Connections	163

2.2.8.5	Web Connections	163
2.2.8.6	Text Import Connections.....	163
2.2.8.7	ADO Recordset Connections	163
2.2.8.8	DAO Recordset Connections	163
2.2.9	Password Verifier Algorithm	163
2.2.10	Encryption (Password to Open)	164
2.2.11	Shared Workbooks.....	165
2.2.11.1	User Log	167
2.2.11.2	Revision Logs	167
2.2.11.3	Revision Records.....	167
2.2.11.4	Insertion / Deletion of Rows / Columns Revision	167
2.2.11.5	Move Cells Revision.....	168
2.2.11.6	Change Cells Revision.....	168
2.2.11.7	Sort Map.....	168
2.2.12	Shared Feature	168
2.3	Record Enumeration	168
2.3.1	By Name	169
2.3.2	By Number	180
2.4	Records	191
2.4.1	AlRuns	191
2.4.2	Area.....	191
2.4.3	AreaFormat.....	192
2.4.4	Array	197
2.4.5	AttachedLabel	198
2.4.6	AutoFilter	199
2.4.7	AutoFilter12.....	201
2.4.8	AutoFilterInfo	204
2.4.9	AxcExt	204
2.4.10	AxesUsed	207
2.4.11	Axis	207
2.4.12	AxisLine	208
2.4.13	AxisParent	209
2.4.14	Backup.....	209
2.4.15	Bar	209
2.4.16	BCUsrs	210
2.4.17	Begin	210
2.4.18	BigName	211
2.4.19	BkHim	211
2.4.20	Blank	212
2.4.21	BOF	212
2.4.22	BookBool	214
2.4.23	BookExt.....	215
2.4.24	BoolErr.....	216
2.4.25	BopPop.....	216
2.4.26	BopPopCustom	218
2.4.27	BottomMargin	219
2.4.28	BoundSheet8	220
2.4.29	BRAI	221
2.4.30	BuiltInFnGroupCount.....	222
2.4.31	CalcCount	223
2.4.32	CalcDelta.....	223
2.4.33	CalcIter	223
2.4.34	CalcMode.....	223
2.4.35	CalcPrecision.....	224
2.4.36	CalcRefMode	224
2.4.37	CalcSaveRecalc	224
2.4.38	CatLab	225
2.4.39	CatSerRange.....	225

2.4.40	CbUsr	227
2.4.41	CellWatch	227
2.4.42	CF	228
2.4.43	CF12	229
2.4.44	CFEx	232
2.4.45	Chart	233
2.4.46	Chart3d	234
2.4.47	Chart3DBarShape	236
2.4.48	ChartFormat	236
2.4.49	ChartFrtInfo	237
2.4.50	CrtClient	238
2.4.51	CodeName	239
2.4.52	CodePage	239
2.4.53	ColInfo	240
2.4.54	Compat12	241
2.4.55	CompressPictures	241
2.4.56	CondFmt	242
2.4.57	CondFmt12	242
2.4.58	Continue	243
2.4.59	ContinueBigName	243
2.4.60	ContinueFrt	244
2.4.61	ContinueFrt11	244
2.4.62	ContinueFrt12	245
2.4.63	Country	245
2.4.64	CrErr	247
2.4.65	CRN	247
2.4.66	CrtLayout12	248
2.4.67	CrtLayout12A	250
2.4.68	CrtLine	252
2.4.69	CrtLink	253
2.4.70	CrtMIFrt	253
2.4.71	CrtMIFrtContinue	254
2.4.72	CUsr	254
2.4.73	Dat	254
2.4.74	DataFormat	255
2.4.75	DataLabExt	255
2.4.76	DataLabExtContents	256
2.4.77	Date1904	257
2.4.78	DBCCell	257
2.4.79	DbOrParamQry	258
2.4.80	DbQuery	258
2.4.81	DBQueryExt	260
2.4.82	DCon	262
2.4.83	DConBin	264
2.4.84	DConn	265
2.4.85	DConName	270
2.4.86	DConRef	271
2.4.87	DefaultRowHeight	272
2.4.88	DefaultText	272
2.4.89	DefColWidth	273
2.4.90	Dimensions	273
2.4.91	DocRoute	274
2.4.92	DropBar	276
2.4.93	DropDownObjIds	277
2.4.94	DSF	277
2.4.95	Dv	277
2.4.96	DVal	280
2.4.97	DXF	281

2.4.98	DxGCol	282
2.4.99	End	282
2.4.100	EndBlock	282
2.4.101	EndObject	284
2.4.102	EntExU2	285
2.4.103	EOF	285
2.4.104	Excel9File	285
2.4.105	ExternName	285
2.4.106	ExternSheet	287
2.4.107	ExtSST	288
2.4.108	ExtString	288
2.4.109	Fbi	289
2.4.110	Fbi2	290
2.4.111	Feat	291
2.4.112	FeatHdr	292
2.4.113	FeatHdr11	293
2.4.114	Feature11	293
2.4.115	Feature12	295
2.4.116	FileLock	295
2.4.117	FilePass	296
2.4.118	FileSharing	297
2.4.119	FilterMode	297
2.4.120	FnGroupName	297
2.4.121	FnGrp12	297
2.4.122	Font	298
2.4.123	FontX	300
2.4.124	Footer	301
2.4.125	ForceFullCalculation	301
2.4.126	Format	302
2.4.127	Formula	309
2.4.128	Frame	310
2.4.129	FrtFontList	311
2.4.130	FrtWrapper	311
2.4.131	GelFrame	312
2.4.132	GridSet	314
2.4.133	GUIDTypeLib	314
2.4.134	Guts	314
2.4.135	HCenter	315
2.4.136	Header	315
2.4.137	HeaderFooter	319
2.4.138	HFPicture	320
2.4.139	HideObj	322
2.4.140	HLink	322
2.4.141	HLinkTooltip	322
2.4.142	HorizontalPageBreaks	323
2.4.143	IFmtRecord	323
2.4.144	Index	323
2.4.145	InterfaceEnd	324
2.4.146	InterfaceHdr	324
2.4.147	Intl	324
2.4.148	Label	325
2.4.149	LabelSst	325
2.4.150	Lbl	325
2.4.151	LeftMargin	328
2.4.152	Legend	328
2.4.153	LegendException	329
2.4.154	Lel	330
2.4.155	Line	330

2.4.156	LineFormat	331
2.4.157	List12	332
2.4.158	LPr	333
2.4.159	LRng	334
2.4.160	MarkerFormat	334
2.4.161	MDB	336
2.4.162	MDTInfo	336
2.4.163	MDXKPI	338
2.4.164	MDXProp	339
2.4.165	MDXSet	339
2.4.166	MDXStr	340
2.4.167	MDXTuple	341
2.4.168	MergeCells	341
2.4.169	Mms	342
2.4.170	MsoDrawing	342
2.4.171	MsoDrawingGroup	342
2.4.172	MsoDrawingSelection	343
2.4.173	MTRSettings	343
2.4.174	MulBlank	344
2.4.175	MulRk	344
2.4.176	NameCmt	345
2.4.177	NameFnGrp12	346
2.4.178	NamePublish	347
2.4.179	Note	347
2.4.180	Number	348
2.4.181	Obj	348
2.4.182	ObjectLink	351
2.4.183	ObjProtect	351
2.4.184	ObNoMacros	352
2.4.185	ObProj	352
2.4.186	OleDbConn	352
2.4.187	OleObjectSize	353
2.4.188	Palette	353
2.4.189	Pane	353
2.4.190	ParamQry	354
2.4.191	Password	354
2.4.192	PhoneticInfo	355
2.4.193	PicF	355
2.4.194	Pie	356
2.4.195	PieFormat	357
2.4.196	PivotChartBits	357
2.4.197	PlotArea	358
2.4.198	PlotGrowth	358
2.4.199	Pls	358
2.4.200	PLV	359
2.4.201	Pos	359
2.4.202	PrintGrid	361
2.4.203	PrintRowCol	361
2.4.204	PrintSize	362
2.4.205	Prot4Rev	362
2.4.206	Prot4RevPass	363
2.4.207	Protect	363
2.4.208	Qsi	363
2.4.209	Qsif	366
2.4.210	Qsir	367
2.4.211	QsiSXTag	369
2.4.212	Radar	371
2.4.213	RadarArea	371

2.4.214	RealTimeData	372
2.4.215	RecalcId	373
2.4.216	RecipName	373
2.4.217	RefreshAll	374
2.4.218	RichTextStream	374
2.4.219	RightMargin	376
2.4.220	RK	376
2.4.221	Row	377
2.4.222	RRAutoFmt	378
2.4.223	RRDChgCell	379
2.4.224	RRDConflict	383
2.4.225	RRDDefName	384
2.4.226	RRDHead	386
2.4.227	RRDInfo	388
2.4.228	RRDInsDel	389
2.4.229	RRDInsDelBegin	390
2.4.230	RRDInsDelEnd	390
2.4.231	RRDMove	390
2.4.232	RRDMoveBegin	391
2.4.233	RRDMoveEnd	391
2.4.234	RRDRenSheet	391
2.4.235	RRDRstEtxp	392
2.4.236	RRDTQSIF	393
2.4.237	RRDUserView	394
2.4.238	RRFormat	395
2.4.239	RRInsertSh	395
2.4.240	RRSort	396
2.4.241	RRTabId	397
2.4.242	SBaseRef	397
2.4.243	Scatter	398
2.4.244	SCENARIO	399
2.4.245	ScenarioProtect	400
2.4.246	ScenMan	400
2.4.247	Scl	401
2.4.248	Selection	401
2.4.249	SerAuxErrBar	402
2.4.250	SerAuxTrend	403
2.4.251	SerFmt	404
2.4.252	Series	405
2.4.253	SeriesList	406
2.4.254	SeriesText	406
2.4.255	SerParent	406
2.4.256	SerToCrt	407
2.4.257	Setup	407
2.4.258	ShapePropsStream	412
2.4.259	SheetExt	413
2.4.260	ShrFmla	414
2.4.261	ShtProps	414
2.4.262	SIIndex	415
2.4.263	Sort	416
2.4.264	SortData	417
2.4.265	SST	419
2.4.266	StartBlock	420
2.4.267	StartObject	425
2.4.268	String	426
2.4.269	Style	426
2.4.270	StyleExt	427
2.4.271	SupBook	428

2.4.272	Surf	430
2.4.273	SXAddl Records	431
2.4.273.1	Continue_SxaddlSxString	431
2.4.273.2	SXAddl	431
2.4.273.3	SXAddl_SXCAutoSort_SXDEnd	432
2.4.273.4	SXAddl_SXCAutoSort_SXDId	432
2.4.273.5	SXAddl_SXCCache_SXDEnd	433
2.4.273.6	SXAddl_SXCCache_SXDId	433
2.4.273.7	SXAddl_SXCCache_SXDInfo12	433
2.4.273.8	SXAddl_SXCCache_SXDInvRefreshReal	434
2.4.273.9	SXAddl_SXCCache_SXDVer10Info	434
2.4.273.10	SXAddl_SXCCache_SXDVerSxMacro	435
2.4.273.11	SXAddl_SXCCache_SXDVerUpdInv	436
2.4.273.12	SXAddl_SXCCacheField_SXDCaption	436
2.4.273.13	SXAddl_SXCCacheField_SXDEND	436
2.4.273.14	SXAddl_SXCCacheField_SXDId	437
2.4.273.15	SXAddl_SXCCacheField_SXDIfdbMempropMap	437
2.4.273.16	SXAddl_SXCCacheField_SXDIfdbMpMapCount	438
2.4.273.17	SXAddl_SXCCacheField_SXDProperty	438
2.4.273.18	SXAddl_SXCCacheField_SXDPropName	439
2.4.273.19	SXAddl_SXCCacheField_SXDSxmitmCount	439
2.4.273.20	SXAddl_SXCCacheItem_SXDEND	440
2.4.273.21	SXAddl_SXCCacheItem_SXDId	440
2.4.273.22	SXAddl_SXCCacheItem_SXDitmMpMapCount	440
2.4.273.23	SXAddl_SXCCacheItem_SXDitmMpropMap	441
2.4.273.24	SXAddl_SXCCacheItem_SXDSxmitmDisp	441
2.4.273.25	SXAddl_SXCField_SXDEND	442
2.4.273.26	SXAddl_SXCField_SXDId	442
2.4.273.27	SXAddl_SXCField_SXDVer10Info	442
2.4.273.28	SXAddl_SXCField12_SXDAutoshow	443
2.4.273.29	SXAddl_SXCField12_SXDEND	443
2.4.273.30	SXAddl_SXCField12_SXDId	444
2.4.273.31	SXAddl_SXCField12_SXDISXTH	444
2.4.273.32	SXAddl_SXCField12_SXDMemberCaption	445
2.4.273.33	SXAddl_SXCField12_SXDVer12Info	445
2.4.273.34	SXAddl_SXCField12_SXDVerUpdInv	446
2.4.273.35	SXAddl_SXCGroup_SXDEND	446
2.4.273.36	SXAddl_SXCGroup_SXDGrpInfo	447
2.4.273.37	SXAddl_SXCGroup_SXDId	448
2.4.273.38	SXAddl_SXCGroup_SXDMember	448
2.4.273.39	SXAddl_SXCGrpLevel_SXDEND	449
2.4.273.40	SXAddl_SXCGrpLevel_SXDGrpLevelInfo	449
2.4.273.41	SXAddl_SXCGrpLevel_SXDId	450
2.4.273.42	SXAddl_SXCHierarchy_SXDDisplayFolder	450
2.4.273.43	SXAddl_SXCHierarchy_SXDEND	451
2.4.273.44	SXAddl_SXCHierarchy_SXDFilterMember	451
2.4.273.45	SXAddl_SXCHierarchy_SXDFilterMember12	452
2.4.273.46	SXAddl_SXCHierarchy_SXDIconSet	453
2.4.273.47	SXAddl_SXCHierarchy_SXDId	453
2.4.273.48	SXAddl_SXCHierarchy_SXDInfo12	454
2.4.273.49	SXAddl_SXCHierarchy_SXDKPIGoal	455
2.4.273.50	SXAddl_SXCHierarchy_SXDKPIStatus	455
2.4.273.51	SXAddl_SXCHierarchy_SXDKPITime	455
2.4.273.52	SXAddl_SXCHierarchy_SXDKPITrend	456
2.4.273.53	SXAddl_SXCHierarchy_SXDKPIValue	456
2.4.273.54	SXAddl_SXCHierarchy_SXDKPIWeight	457
2.4.273.55	SXAddl_SXCHierarchy_SXDMeasureGrp	457
2.4.273.56	SXAddl_SXCHierarchy_SXDParentKPI	458

2.4.273.57	SXAddl_SXCHierarchy_SXDProperty	458
2.4.273.58	SXAddl_SXCHierarchy_SXDSXSetParentUnique	460
2.4.273.59	SXAddl_SXCHierarchy_SXDUserCaption	460
2.4.273.60	SXAddl_SXCHierarchy_SXDVerUpdInv	460
2.4.273.61	SXAddl_SXCQsi_SXDEnd	461
2.4.273.62	SXAddl_SXCQsi_SXDId	461
2.4.273.63	SXAddl_SXCQuery_SXDEnd	461
2.4.273.64	SXAddl_SXCQuery_SXDReconnCond	462
2.4.273.65	SXAddl_SXCQuery_SXDSrcConnFile	463
2.4.273.66	SXAddl_SXCQuery_SXDSrcDataFile	463
2.4.273.67	SXAddl_SXCQuery_SXDXMLSource	463
2.4.273.68	SXAddl_SXCSXCondFmt_SXDEnd	464
2.4.273.69	SXAddl_SXCSXCondFmt_SXDSXCondFmt	464
2.4.273.70	SXAddl_SXCSXCondFmts_SXDEnd	465
2.4.273.71	SXAddl_SXCSXCondFmts_SXDId	466
2.4.273.72	SXAddl_SXCSXDH_SXDEnd	466
2.4.273.73	SXAddl_SXCSXDH_SXDId	467
2.4.273.74	SXAddl_SXCSXDH_SXDSxdh	467
2.4.273.75	SXAddl_SXCSXfilt_SXDEnd	468
2.4.273.76	SXAddl_SXCSXfilt_SXDId	469
2.4.273.77	SXAddl_SXCSXfilt_SXDSXfilt	469
2.4.273.78	SXAddl_SXCSXfilt_SXDSXitm	470
2.4.273.79	SXAddl_SXCSXFilter12_SXDCaption	471
2.4.273.80	SXAddl_SXCSXFilter12_SXDEnd	472
2.4.273.81	SXAddl_SXCSXFilter12_SXDId	472
2.4.273.82	SXAddl_SXCSXFilter12_SXDSXFilter	472
2.4.273.83	SXAddl_SXCSXFilter12_SXDSXFilterDesc	474
2.4.273.84	SXAddl_SXCSXFilter12_SXDSXFilterValue1	474
2.4.273.85	SXAddl_SXCSXFilter12_SXDSXFilterValue2	474
2.4.273.86	SXAddl_SXCSXFilter12_SXDIsFilter	475
2.4.273.87	SXAddl_SXCSXFilter12_SXDIsFilterValue1	475
2.4.273.88	SXAddl_SXCSXFilter12_SXDIsFilterValue2	476
2.4.273.89	SXAddl_SXCSXFilters12_SXDEnd	476
2.4.273.90	SXAddl_SXCSXFilters12_SXDId	477
2.4.273.91	SXAddl_SXCSXMg_SXDEnd	477
2.4.273.92	SXAddl_SXCSXMg_SXDId	477
2.4.273.93	SXAddl_SXCSXMg_SXDUserCaption	478
2.4.273.94	SXAddl_SXCSXMgs_SXDEnd	478
2.4.273.95	SXAddl_SXCSXMgs_SXDId	478
2.4.273.96	SXAddl_SXCSXMgs_SXDMGrpSXDHMap	479
2.4.273.97	SXAddl_SXCSXrule_SXDEnd	480
2.4.273.98	SXAddl_SXCSXrule_SXDId	480
2.4.273.99	SXAddl_SXCSXrule_SXDSXrule	480
2.4.273.100	SXAddl_SXCView_SXDCalcMember	483
2.4.273.101	SXAddl_SXCView_SXDCalcMemString	485
2.4.273.102	SXAddl_SXCView_SXDCompactColHdr	485
2.4.273.103	SXAddl_SXCView_SXDCompactRwHdr	486
2.4.273.104	SXAddl_SXCView_SXDEnd	486
2.4.273.105	SXAddl_SXCView_SXDId	487
2.4.273.106	SXAddl_SXCView_SXDSXPIIvmb	487
2.4.273.107	SXAddl_SXCView_SXDTableStyleClient	488
2.4.273.108	SXAddl_SXCView_SXDVer10Info	488
2.4.273.109	SXAddl_SXCView_SXDVer12Info	490
2.4.273.110	SXAddl_SXCView_SXDVerUpdInv	492
2.4.274	SxBool	493
2.4.275	SXDB	493
2.4.276	SXDBB	494
2.4.277	SXDBEx	494

2.4.278	SXDI	495
2.4.279	SXDtr	497
2.4.280	SxDXF	497
2.4.281	SxErr	498
2.4.282	SXEx	498
2.4.283	SXFDB	501
2.4.284	SXFDBType	504
2.4.285	SxFilt	504
2.4.286	SxFmla	505
2.4.287	SxFormat	506
2.4.288	SXFormula	506
2.4.289	SXInt	506
2.4.290	SxIsxoper	507
2.4.291	SxItm	507
2.4.292	SxIvd	508
2.4.293	SXLI	509
2.4.294	SxName	509
2.4.295	SxNil	510
2.4.296	SXNum	510
2.4.297	SXPair	510
2.4.298	SXPI	511
2.4.299	SXPIEx	512
2.4.300	SXRng	512
2.4.301	SxRule	514
2.4.302	SxSelect	516
2.4.303	SXStreamID	518
2.4.304	SXString	518
2.4.305	SXTbl	518
2.4.306	SxTbpg	519
2.4.307	SXTBRGIITM	520
2.4.308	SXTH	520
2.4.309	Sxvd	523
2.4.310	SXVDEx	527
2.4.311	SXVDTEx	530
2.4.312	SXVI	531
2.4.313	SxView	533
2.4.314	SXViewEx	535
2.4.315	SXViewEx9	536
2.4.316	SXViewLink	537
2.4.317	SXVS	538
2.4.318	Sync	538
2.4.319	Table	538
2.4.320	TableStyle	540
2.4.321	TableStyleElement	541
2.4.322	TableStyles	544
2.4.323	Template	545
2.4.324	Text	545
2.4.325	TextPropsStream	550
2.4.326	Theme	552
2.4.327	Tick	552
2.4.328	TopMargin	555
2.4.329	TxO	556
2.4.330	TxtQry	558
2.4.331	Uncalcd	560
2.4.332	Units	560
2.4.333	UserBView	560
2.4.334	UserSViewBegin	564
2.4.335	UserSViewBegin_Chart	567

2.4.336	UserSViewEnd	569
2.4.337	UsesELFs	569
2.4.338	UsrChk	569
2.4.339	UsrExcl.....	570
2.4.340	UsrInfo.....	571
2.4.341	ValueRange	571
2.4.342	VCenter.....	574
2.4.343	VerticalPageBreaks	574
2.4.344	WebPub.....	574
2.4.345	Window1	577
2.4.346	Window2	578
2.4.347	WinProtect.....	580
2.4.348	WOpt	581
2.4.349	WriteAccess	582
2.4.350	WriteProtect.....	583
2.4.351	WsBool.....	583
2.4.352	XCT	584
2.4.353	XF	584
2.4.354	XFCRC.....	585
2.4.355	XFExt	585
2.4.356	YMult	586
2.5	Structures.....	587
2.5.1	AddinUdf	587
2.5.2	AF12CellIcon.....	587
2.5.3	AF12Criteria.....	588
2.5.4	AF12DateInfo.....	588
2.5.5	AFDOper.....	589
2.5.6	AFDOperBoolErr	590
2.5.7	AFDOperRk	591
2.5.8	AFDOperStr	591
2.5.9	AutoFmt8	592
2.5.10	Bes	593
2.5.11	Bold	594
2.5.12	BookExt_Conditional11.....	594
2.5.13	BookExt_Conditional12.....	594
2.5.14	Boolean.....	595
2.5.15	BorderStyle.....	595
2.5.16	BuiltInStyle.....	596
2.5.17	CachedDiskHeader.....	596
2.5.18	Cch255.....	597
2.5.19	Cell	597
2.5.20	CellXF	597
2.5.21	CFColor	601
2.5.22	CFDatabar	601
2.5.23	CFExAveragesTemplateParams.....	603
2.5.24	CFExDateTemplateParams	603
2.5.25	CFExDefaultTemplateParams.....	604
2.5.26	CFExFilterParams.....	604
2.5.27	CFExNonCF12	605
2.5.28	CFExTemplateParams.....	607
2.5.29	CFExTextTemplateParams.....	608
2.5.30	CFFilter	608
2.5.31	CFFlag.....	609
2.5.32	CFGradient	610
2.5.33	CFGradientInterpItem	610
2.5.34	CFGradientItem.....	611
2.5.35	CFMStateItem	612
2.5.36	CFMultistate.....	612

2.5.37	CFrtId	613
2.5.38	CFT	614
2.5.39	CFVO	615
2.5.40	ChartNumNillable.....	616
2.5.41	Col.....	616
2.5.42	Col_NegativeOne	616
2.5.43	Col12	617
2.5.44	Col256U	617
2.5.45	ColByte	617
2.5.46	ColByteU	618
2.5.47	ColElfU	618
2.5.48	ColorICV.....	618
2.5.49	ColorTheme	619
2.5.50	ColRelNegU.....	619
2.5.51	ColRelU	620
2.5.52	ColSlco8U	620
2.5.53	ColU.....	620
2.5.54	Colx	621
2.5.55	CondDataValue.....	621
2.5.56	CondFmtStructure	621
2.5.57	ConnGrbitDbt	622
2.5.58	ConnGrbitDbtAdo.....	622
2.5.59	ConnGrbitDbtOledb	623
2.5.60	ConnGrbitDbtWeb.....	624
2.5.61	ControlInfo	625
2.5.62	CrtLayout12Mode	625
2.5.63	DataFunctionalityLevel	626
2.5.64	DataSourceType	626
2.5.65	DateAsNum.....	626
2.5.66	DateUnit.....	626
2.5.67	DCol	627
2.5.68	DColByteU	627
2.5.69	DConFile.....	627
2.5.70	DConnConnectionOleDb.....	628
2.5.71	DConnConnectionWeb	629
2.5.72	DConnId	629
2.5.73	DConnParamBinding	630
2.5.74	DConnParamBindingValByte	630
2.5.75	DConnParamBindingValInt	630
2.5.76	DConnParamBindingValString.....	630
2.5.77	DConnParamBindingValType	631
2.5.78	DConnParameter	631
2.5.79	DConnStringSequence.....	632
2.5.80	DConnUnicodeStringSegmented	632
2.5.81	DJoin	633
2.5.82	DRw.....	633
2.5.83	DRwByteU	633
2.5.84	Duce	633
2.5.85	DuceRadical	634
2.5.86	DuceStacked	635
2.5.87	Ducr	635
2.5.88	DucrConditionalLbl	636
2.5.89	DucrConditionalNoLbl	637
2.5.90	DwQsiFuture	637
2.5.91	DXFALC	638
2.5.92	DXFBdr.....	639
2.5.93	DXFFntD.....	640
2.5.94	DXFId	641

2.5.95	DXFN	641
2.5.96	DXFN12	644
2.5.97	DXFN12List	645
2.5.98	DXFN12NoCB	645
2.5.99	DXFNum	645
2.5.100	DXFNumIFmt	646
2.5.101	DXFNumUsr	646
2.5.102	DXFPat	646
2.5.103	DXFProt	647
2.5.104	EnhancedProtection	647
2.5.105	ExternDdeLinkNoOper	648
2.5.106	ExternDocName	648
2.5.107	ExternOleDdeLink	649
2.5.108	ExtProp	649
2.5.109	ExtRst	650
2.5.110	FactoidData	651
2.5.111	Feat11CellStruct	651
2.5.112	Feat11FdaAutoFilter	651
2.5.113	Feat11FieldDataItem	652
2.5.114	Feat11Fmla	659
2.5.115	Feat11RgInvalidCells	659
2.5.116	Feat11RgSharepointIdChange	659
2.5.117	Feat11RgSharepointIdDel	660
2.5.118	Feat11TotalFmla	660
2.5.119	Feat11WSSListInfo	660
2.5.120	Feat11XMap	663
2.5.121	Feat11XMapEntry	663
2.5.122	Feat11XMapEntry2	664
2.5.123	FeatFormulaErr2	664
2.5.124	FeatProtection	664
2.5.125	FeatSmartTag	665
2.5.126	FFErrorCheck	666
2.5.127	FillPattern	666
2.5.128	FillStylePropertiesForShapePropsStreamChecksum	667
2.5.129	FontIndex	677
2.5.130	FontInfo	677
2.5.131	FontScheme	678
2.5.132	FormatRun	678
2.5.133	FormulaValue	678
2.5.134	FrtFlags	679
2.5.135	FrtHeader	680
2.5.136	FrtHeaderOld	680
2.5.137	FrtRefHeader	680
2.5.138	FrtRefHeaderNoGrbit	681
2.5.139	FrtRefHeaderU	681
2.5.140	FtCbIs	682
2.5.141	FtCbIsData	682
2.5.142	FtCf	683
2.5.143	FtCmo	683
2.5.144	FtEdoData	686
2.5.145	FtGboData	687
2.5.146	FtGmo	687
2.5.147	FtLbsData	688
2.5.148	FtMacro	690
2.5.149	FtNts	691
2.5.150	FtPictFmla	691
2.5.151	FtPioGrbit	692
2.5.152	FtRbo	694

2.5.153	FtRboData	694
2.5.154	FtSbs	695
2.5.155	FullColorExt	696
2.5.156	GradStop	696
2.5.157	HiddenMemberSet	697
2.5.158	HideObjEnum	697
2.5.159	HorizAlign	698
2.5.160	HorzBrk	698
2.5.161	Icv	698
2.5.162	IcvChart	702
2.5.163	IcvFont	702
2.5.164	IcvXF	702
2.5.165	IFmt	702
2.5.166	InteriorColorPropertiesForShapePropsStreamChecksum	703
2.5.167	ISSTInf	704
2.5.168	IXFCell	704
2.5.169	KPIProp	704
2.5.170	KPISets	705
2.5.171	LbsDropData	705
2.5.172	LEMMode	706
2.5.173	LinePropertiesForShapePropsStreamChecksum	707
2.5.174	List12BlockLevel	708
2.5.175	List12DisplayName	710
2.5.176	List12TableStyleClientInfo	711
2.5.177	LongRGB	711
2.5.178	LongRGBA	712
2.5.179	LPWideString	712
2.5.180	MDir	712
2.5.181	MDTInfoIndex	713
2.5.182	MDXStrIndex	713
2.5.183	MOper	713
2.5.184	NilChartNum	714
2.5.185	NoteRR	714
2.5.186	NoteSh	715
2.5.187	ObjFmla	716
2.5.188	ObjId	717
2.5.189	ObjLinkFmla	717
2.5.190	ODBCType	718
2.5.191	OfficeArtClientAnchorChart	718
2.5.192	OfficeArtClientAnchorHF	719
2.5.193	OfficeArtClientAnchorSheet	720
2.5.194	OfficeArtClientData	721
2.5.195	OfficeArtClientTextbox	722
2.5.196	PaneType	722
2.5.197	PARAMQRY_Fixed	723
2.5.198	Parsed Expressions	724
2.5.198.1	ArrayParsedFormula	724
2.5.198.2	BErr	724
2.5.198.3	CellParsedFormula	725
2.5.198.4	Cetab	725
2.5.198.5	CFParsedFormula	754
2.5.198.6	CFParsedFormulaNoCCE	754
2.5.198.7	CFVOParsedFormula	754
2.5.198.8	ChartParsedFormula	755
2.5.198.9	DVParsedFormula	755
2.5.198.10	ExtNameParsedFormula	756
2.5.198.11	ExtPtgArea3D	757
2.5.198.12	ExtPtgAreaErr3D	757

2.5.198.13	ExtPtgErr	757
2.5.198.14	ExtPtgRef3D	758
2.5.198.15	ExtPtgRefErr3D	758
2.5.198.16	ExtSheetPair	758
2.5.198.17	Ftab	759
2.5.198.18	Ilel	786
2.5.198.19	ListParsedArrayFormula	787
2.5.198.20	ListParsedFormula	787
2.5.198.21	NameParsedFormula	787
2.5.198.22	ObjectParsedFormula	788
2.5.198.23	ParameterParsedFormula	788
2.5.198.24	PivotParsedFormula	789
2.5.198.25	Ptg	789
2.5.198.26	PtgAdd	792
2.5.198.27	PtgArea	792
2.5.198.28	PtgArea3d	793
2.5.198.29	PtgAreaErr	793
2.5.198.30	PtgAreaErr3d	794
2.5.198.31	PtgAreaN	794
2.5.198.32	PtgArray	795
2.5.198.33	PtgAttrBaxcel	795
2.5.198.34	PtgAttrChoose	796
2.5.198.35	PtgAttrGoto	796
2.5.198.36	PtgAttrIf	797
2.5.198.37	PtgAttrSemi	797
2.5.198.38	PtgAttrSpace	797
2.5.198.39	PtgAttrSpaceSemi	798
2.5.198.40	PtgAttrSpaceType	798
2.5.198.41	PtgAttrSum	799
2.5.198.42	PtgBool	799
2.5.198.43	PtgConcat	799
2.5.198.44	PtgDataType	799
2.5.198.45	PtgDiv	800
2.5.198.46	PtgElfCol	800
2.5.198.47	PtgElfColS	800
2.5.198.48	PtgElfColSV	801
2.5.198.49	PtgElfColV	801
2.5.198.50	PtgElfLel	801
2.5.198.51	PtgElfRadical	802
2.5.198.52	PtgElfRadicalLel	802
2.5.198.53	PtgElfRadicalS	803
2.5.198.54	PtgElfRw	803
2.5.198.55	PtgElfRwV	804
2.5.198.56	PtgEq	804
2.5.198.57	PtgErr	804
2.5.198.58	PtgExp	804
2.5.198.59	PtgExtraArray	805
2.5.198.60	PtgExtraElf	805
2.5.198.61	PtgExtraMem	806
2.5.198.62	PtgFunc	806
2.5.198.63	PtgFuncVar	806
2.5.198.64	PtgGe	807
2.5.198.65	PtgGt	807
2.5.198.66	PtgInt	807
2.5.198.67	PtgIsect	808
2.5.198.68	PtgLe	808
2.5.198.69	PtgLt	808
2.5.198.70	PtgMemArea	808

2.5.198.71	PtgMemErr	809
2.5.198.72	PtgMemFunc	809
2.5.198.73	PtgMemNoMem	810
2.5.198.74	PtgMissArg	810
2.5.198.75	PtgMul	810
2.5.198.76	PtgName	811
2.5.198.77	PtgNameX	811
2.5.198.78	PtgNe	812
2.5.198.79	PtgNum	812
2.5.198.80	PtgParen	812
2.5.198.81	PtgPercent	813
2.5.198.82	PtgPower	813
2.5.198.83	PtgRange	813
2.5.198.84	PtgRef	813
2.5.198.85	PtgRef3d	814
2.5.198.86	PtgRefErr	814
2.5.198.87	PtgRefErr3d	815
2.5.198.88	PtgRefN	815
2.5.198.89	PtgStr	815
2.5.198.90	PtgSub	816
2.5.198.91	PtgSxName	816
2.5.198.92	PtgTbl	816
2.5.198.93	PtgUminus	817
2.5.198.94	PtgUnion	817
2.5.198.95	PtgUplus	817
2.5.198.96	RevExtern	818
2.5.198.97	RevItab	818
2.5.198.98	RevLblName	819
2.5.198.99	RevName	820
2.5.198.100	RevNamePly	821
2.5.198.101	RevNameTabid	821
2.5.198.102	RevSheetName	821
2.5.198.103	RgbExtra	822
2.5.198.104	Rgce	823
2.5.198.105	RgceArea	826
2.5.198.106	RgceAreaRel	827
2.5.198.107	RgceElfLoc	827
2.5.198.108	RgceElfLocExtra	828
2.5.198.109	RgceLoc	828
2.5.198.110	RgceLoc8	828
2.5.198.111	RgceLocRel	828
2.5.198.112	SerAr	829
2.5.198.113	SerBool	829
2.5.198.114	SerErr	830
2.5.198.115	SerNil	830
2.5.198.116	SerNum	830
2.5.198.117	SerStr	831
2.5.198.118	SharedParsedFormula	831
2.5.198.119	XtiIndex	832
2.5.199	PBT	832
2.5.200	PhRuns	833
2.5.201	Phs	833
2.5.202	PictFmlaEmbedInfo	834
2.5.203	PictFmlaKey	834
2.5.204	PivotCompProp	835
2.5.205	PositionMode	835
2.5.206	ReadingOrder	835
2.5.207	Ref	836

2.5.208	Ref8	836
2.5.209	Ref8U	837
2.5.210	Ref8U2007	837
2.5.211	RefU	838
2.5.212	RevisionType	838
2.5.213	RFX	839
2.5.214	RichTextStreamChecksumData	839
2.5.215	RichTextStreamChecksumFontInformation	841
2.5.216	RichTextStreamChecksumFontInformationArrayItem	843
2.5.217	RkNumber	843
2.5.218	RkRec	844
2.5.219	RPHSSub	844
2.5.220	RRD	845
2.5.221	RRDDefNameFlags	845
2.5.222	RRLoc	847
2.5.223	RTDEItem	847
2.5.224	RTDOper	847
2.5.225	RTDOperStr	848
2.5.226	Run	848
2.5.227	Rw	848
2.5.228	Rw12	849
2.5.229	RwLongU	849
2.5.230	RwU	849
2.5.231	Rwx	849
2.5.232	Script	850
2.5.233	SD_SetSortOrder	850
2.5.234	SDContainer	850
2.5.235	SecurityDescriptor	851
2.5.236	ShapePropsStreamChecksumData	851
2.5.237	SharedFeatureType	852
2.5.238	SheetExtOptional	853
2.5.239	ShortDTR	854
2.5.240	ShortXLUnicodeString	854
2.5.241	SLCO8	855
2.5.242	SortCond12	855
2.5.243	SortItem	856
2.5.244	SourceType	857
2.5.245	SQElfFlags	857
2.5.246	SqRef	857
2.5.247	SqRefU	858
2.5.248	Stxp	858
2.5.249	StyleXF	859
2.5.250	SXAddl_SXDEnd	861
2.5.251	SXAddl_SXDVerUpdInv	861
2.5.252	SXAddl_SXString	861
2.5.253	SXAddlHdr	862
2.5.254	SXAxis	862
2.5.255	SXEZDoper	862
2.5.256	SxFT	863
2.5.257	SxIvdCol	867
2.5.258	SxIvdRw	867
2.5.259	SXLIItem	867
2.5.260	SXPI_Item	870
2.5.261	SXVDEx_Opt	870
2.5.262	SXView9Save	871
2.5.263	SXVIFlags	871
2.5.264	TabId	872
2.5.265	TabIndex	872

2.5.266	TableFeatureType	872
2.5.267	Tag_Fn_MDX.....	876
2.5.268	TextPropsStreamChecksumData	877
2.5.269	Top10FT	879
2.5.270	Ts	879
2.5.271	TxOLastRun	879
2.5.272	TxORuns.....	880
2.5.273	TxtWf.....	880
2.5.274	Underline.....	881
2.5.275	VertAlign	881
2.5.276	VertBrk	881
2.5.277	VirtualPath.....	881
2.5.278	WebPubString	883
2.5.279	XColorType	884
2.5.280	XFExtGradient	884
2.5.281	XFExtNoFRT	885
2.5.282	XFIndex.....	885
2.5.283	XFProp	887
2.5.284	XFPropBorder	889
2.5.285	XFPropColor	889
2.5.286	XFPropGradient	890
2.5.287	XFPropGradientStop	891
2.5.288	XFProps.....	891
2.5.289	XFPropTextRotation	892
2.5.290	XLNameUnicodeString	892
2.5.291	XlsFilter_Criteria.....	893
2.5.292	XlsFilter_Top10	894
2.5.293	XLUnicodeRichExtendedString	895
2.5.294	XLUnicodeString	896
2.5.295	XLUnicodeStringMin2	897
2.5.296	XLUnicodeStringNoCch	897
2.5.297	XLUnicodeStringSegmented	897
2.5.298	XLUnicodeStringSegmentedRTD	898
2.5.299	XLUnicodeStringSegmentedSXAddl	898
2.5.300	XmiTkBackWallThicknessFrt	899
2.5.301	XmiTkBaseTimeUnitFrt	899
2.5.302	XmiTkBlob	900
2.5.303	XmiTkBool	900
2.5.304	XmiTkChain	901
2.5.305	XmiTkColorMappingOverride	903
2.5.306	XmiTkDispBlanksAsFrt.....	903
2.5.307	XmiTkDouble.....	904
2.5.308	XmiTkDWord.....	904
2.5.309	XmiTkEnd	905
2.5.310	XmiTkEndSurface	905
2.5.311	XmiTkFloorThicknessFrt.....	905
2.5.312	XmiTkFormatCodeFrt	906
2.5.313	XmiTkHeader	906
2.5.314	XmiTkHeightPercent.....	906
2.5.315	XmiTkLogBaseFrt.....	907
2.5.316	XmiTkMajorUnitFrt	907
2.5.317	XmiTkMajorUnitTypeFrt	907
2.5.318	XmiTkMaxFrt.....	908
2.5.319	XmiTkMinFrt.....	908
2.5.320	XmiTkMinorUnitFrt	909
2.5.321	XmiTkMinorUnitTypeFrt	909
2.5.322	XmiTkNoMultiLvlLbl.....	910
2.5.323	XmiTkOverlay	910

2.5.324	XmITkPerspectiveFrt	911
2.5.325	XmITkPieComboFrom12Frt.....	911
2.5.326	XmITkRangAxOffFrt	911
2.5.327	XmITkRotXFrt.....	912
2.5.328	XmITkRotYFrt	912
2.5.329	XmITkShowDLblsOverMax.....	912
2.5.330	XmITkSpb	913
2.5.331	XmITkStart	913
2.5.332	XmITkStartSurface.....	913
2.5.333	XmITkString.....	914
2.5.334	XmITkStyle	914
2.5.335	XmITkSymbolFrt.....	914
2.5.336	XmITkThemeOverride.....	915
2.5.337	XmITkTickLabelPositionFrt.....	915
2.5.338	XmITkTickLabelSkipFrt	916
2.5.339	XmITkTickMarkSkipFrt	916
2.5.340	XmITkToken.....	916
2.5.341	XmITkTpb	917
2.5.342	Xnum	917
2.5.343	XORObfuscation	917
2.5.344	XTI	917
2.6	XCB Structures	919
2.6.1	CTBWRAPPER.....	919
2.6.2	CTBS.....	919
2.6.3	CTB	920
2.6.4	TBC	921
2.6.5	TBCCmd	922
2.7	Algorithms	923
2.7.1	Application Data For VtHyperlink	923
3	Structure Examples	924
3.1	Conditional Formatting.....	924
3.1.1	Conditional Formatting: CondFmt	924
3.1.2	Conditional Formatting: CF	926
3.2	Defined Name.....	933
3.2.1	Defined Name: Lbl.....	933
3.2.2	Defined Name: ExternSheet.....	935
3.2.3	Defined Name: SupBook.....	936
3.3	Table.....	936
3.3.1	Table: Feathdr11	936
3.3.2	Table: Feature11	937
3.4	Filters.....	946
3.4.1	Filters: FilterMode.....	946
3.4.2	Filters: AutoFilterInfo	947
3.4.3	Filters: AutoFilter.....	947
3.5	External References.....	948
3.5.1	External References: Formula.....	949
3.5.2	External References: String	951
3.5.3	External References: SupBook 1	952
3.5.4	External References: XCT	952
3.5.5	External References: CRN	953
3.5.6	External References: SupBook 2.....	954
3.5.7	External References: ExternSheet.....	954
3.6	Column Chart Object	955
3.6.1	Column Chart Object: Chart.....	956
3.6.2	Column Chart Object: Frame.....	956
3.6.3	Column Chart Object: LineFormat.....	957
3.6.4	Column Chart Object: AreaFormat	958

3.6.5	Column Chart Object: Series	959
3.6.6	Column Chart Object: BRAI 1	959
3.6.7	Column Chart Object: SeriesText	961
3.6.8	Column Chart Object: BRAI 2	961
3.6.9	Column Chart Object: BRAI 3	963
3.6.10	Column Chart Object: DataFormat	965
3.6.11	Column Chart Object: SerToCrt	965
3.6.12	Column Chart Object: ShtProps	965
3.6.13	Column Chart Object: DefaultText	966
3.6.14	Column Chart Object: Text	966
3.6.15	Column Chart Object: FontX	968
3.6.16	Column Chart Object: AxesUsed	968
3.6.17	Column Chart Object: AxisParent	969
3.6.18	Column Chart Object: Axis	969
3.6.19	Column Chart Object: CatSerRange	969
3.6.20	Column Chart Object: Tick	970
3.6.21	Column Chart Object: ChartFormat	971
3.6.22	Column Chart Object: Bar	972
3.7	Pie Chart Sheet	973
3.7.1	Pie Chart Sheet: PrintSize	973
3.7.2	Pie Chart Sheet: Chart	973
3.7.3	Pie Chart Sheet: ShtProps	974
3.7.4	Pie Chart Sheet: AxesUsed	974
3.7.5	Pie Chart Sheet: AxisParent	975
3.7.6	Pie Chart Sheet: ChartFormat	975
3.7.7	Pie Chart Sheet: Pie	975
3.7.8	Pie Chart Sheet: Legend	976
3.7.9	Pie Chart Sheet: Pos	977
3.7.10	Pie Chart Sheet: Text	978
3.7.11	Pie Chart Sheet: BRAI	980
3.7.12	Pie Chart Sheet: Window2	980
3.8	Formatting	981
3.8.1	Formatting: Font 1	982
3.8.2	Formatting: Font 2	983
3.8.3	Formatting: Format	984
3.8.4	Formatting: XF 1	985
3.8.5	Formatting: XF 2	987
3.8.6	Formatting: XF 3	989
3.8.7	Formatting: XF 4	991
3.8.8	Formatting: Number 1	993
3.8.9	Formatting: Number 2	994
3.8.10	Formatting: Number 3	995
3.9	Workbook	995
3.9.1	Workbook: BOF 1	996
3.9.2	Workbook: RRTabId	997
3.9.3	Workbook: BuiltInFnGroupCount	998
3.9.4	Workbook: Window1	998
3.9.5	Workbook: HideObj	1000
3.9.6	Workbook: Date1904	1000
3.9.7	Workbook: CalcPrecision	1000
3.9.8	Workbook: BookBool	1000
3.9.9	Workbook: Font	1001
3.9.10	Workbook: Format	1002
3.9.11	Workbook: XF	1003
3.9.12	Workbook: Style	1005
3.9.13	Workbook: BoundSheet8 1	1006
3.9.14	Workbook: BoundSheet8 2	1006
3.9.15	Workbook: BoundSheet8 3	1007

3.9.16	Workbook: Country	1007
3.9.17	Workbook: RecalcId	1008
3.9.18	Workbook: SST	1008
3.9.19	Workbook: ExtSST	1008
3.9.20	Workbook: BookExt	1009
3.9.21	Workbook: EOF 1	1011
3.9.22	Workbook: BOF 2	1011
3.9.23	Workbook: Index	1012
3.9.24	Workbook: DefaultRowHeight	1013
3.9.25	Workbook: WsBool	1013
3.9.26	Workbook: Setup	1014
3.9.27	Workbook: DefColWidth	1016
3.9.28	Workbook: Dimensions	1016
3.9.29	Workbook: Row 1	1017
3.9.30	Workbook: Row 2	1018
3.9.31	Workbook: Row 3	1019
3.9.32	Workbook: Row 4	1019
3.9.33	Workbook: LabelSst 1	1020
3.9.34	Workbook: RK	1021
3.9.35	Workbook: LabelSst 2	1022
3.9.36	Workbook: Formula	1023
3.9.37	Workbook: DBCell	1026
3.9.38	Workbook: Window2	1026
3.9.39	Workbook: Selection	1028
3.9.40	Workbook: PhoneticInfo	1029
3.9.41	Workbook: EOF 2	1030
3.10	PivotTable	1030
3.10.1	PivotTable: SXStreamID	1031
3.10.2	PivotTable: SXVS	1031
3.10.3	PivotTable: DConRef	1032
3.10.4	PivotTable: SXAddl 1	1033
3.10.5	PivotTable: SXAddl 2	1034
3.10.6	PivotTable: SXAddl 3	1035
3.10.7	PivotTable: SxView	1035
3.10.8	PivotTable: Sxvd 1	1039
3.10.9	PivotTable: SXVI 1	1040
3.10.10	PivotTable: SXVI 2	1041
3.10.11	PivotTable: SXVI 3	1041
3.10.12	PivotTable: SXVI 4	1042
3.10.13	PivotTable: SXVDEx 1	1043
3.10.14	PivotTable: Sxvd 2	1044
3.10.15	PivotTable: SXVI 5	1046
3.10.16	PivotTable: SXVI 6	1046
3.10.17	PivotTable: SXVI 7	1047
3.10.18	PivotTable: SXVDEx 2	1047
3.10.19	PivotTable: Sxvd 3	1048
3.10.20	PivotTable: Sxvd 4	1049
3.10.21	PivotTable: SXVDEx 3	1051
3.10.22	PivotTable: Sxvd 5	1052
3.10.23	PivotTable: SXVDEx 4	1053
3.10.24	PivotTable: SxIvd	1055
3.10.25	PivotTable: SXPI	1055
3.10.26	PivotTable: SXDI	1056
3.10.27	PivotTable: SXLI 1	1056
3.10.28	PivotTable: SXLI 2	1062
3.10.29	PivotTable: SXEx	1063
3.10.30	PivotTable: QsiSXTag	1065
3.10.31	PivotTable: SXViewEx9	1067

3.10.32	PivotTable: SxAddl 4	1067
3.10.33	PivotTable: SxAddl 5	1068
3.10.34	PivotTable: SxAddl 6	1070
3.10.35	PivotTable: SXDB	1070
3.10.36	PivotTable: SXDBEx	1072
3.10.37	PivotTable: SXFDB 1	1072
3.10.38	PivotTable: SXString 1	1074
3.10.39	PivotTable: SXString 2	1074
3.10.40	PivotTable: SXString 3	1074
3.10.41	PivotTable: SXFDB 2	1075
3.10.42	PivotTable: SXDtr 1	1076
3.10.43	PivotTable: SXDtr 2	1076
3.10.44	PivotTable: SXFDB 3	1077
3.10.45	PivotTable: SXFDB 4	1078
3.10.46	PivotTable: SXNum 1	1079
3.10.47	PivotTable: SXFDB 5	1080
3.10.48	PivotTable: SXDBB 1	1081
3.10.49	PivotTable: SXNum 2	1081
3.10.50	PivotTable: SXDBB 2	1082
3.10.51	PivotTable: SXNum 3	1082
3.10.52	PivotTable: EOF	1083
4	Security Considerations	1084
5	Appendix A: Product Behavior	1085
6	Change Tracking	1095
7	Index	1096

1 Introduction

The Excel Binary File Format (.xls) Structure specifies the Excel Binary File Format (.xls). The Excel Binary File Format (.xls) is a collection of records and structures that specify **workbook** content, which can include unstructured or semi-structured tables of numbers, text, or both numbers and text, formulas, external data connections, charts, and images. Workbook content is typically organized in a grid based layout, and often includes numeric data, structured data, and formulas.

Sections 1.7 and 2 of this specification are normative. All other sections and examples in this specification are informative.

1.1 Glossary

This document uses the following terms:

3-D Phong shading: A shading algorithm that is used to apply shading to 3-D charts. The algorithm interpolates color between points on the surface of a chart to give a smooth 3-D appearance.

A1: A **reference style** in which each column is identified sequentially from left-to-right with a letter or series of letters in alphabetical order. Column headings are ordered A-Z, then AA-AZ, BA-BZ... ZA-ZZ, AAA-AAZ, and so forth. Each row is numbered sequentially from the top down.

absolute reference: A reference to a fixed location on a **sheet (1)**. An absolute reference always refers to the same range, even if the formula that contains it is moved or copied to a new location.

accelerator key: Any combination of keys that are pressed simultaneously to run a command.

active cell: The cell that is currently selected in a worksheet.

active pane: The pane that currently has focus or contains the current selection or object.

active sheet: The sheet that is currently selected.

ActiveX control: A reusable software control, such as a check box or button, that uses ActiveX technology and provides options to users or runs macros or scripts that automate a task. See also **ActiveX object**.

ActiveX Data Objects (ADO): A data access interface that connects to, retrieves, manipulates, and updates data in **Object Linking and Embedding (OLE)** database-compliant data sources.

ActiveX object: An object that is supplied by a component that supports automation.

add-in: Supplemental functionality that is provided by an external application or macro to extend the capabilities of an application.

add-in function: A worksheet function that is provided by an **add-in**, instead of being built-in.

advanced filter: An extended filter option that enables users to specify complex filter criteria and a destination range for the filter results.

aggregation function: A function, such as sum or average, that appears in the total row of a table and is used to summarize data.

ALL: See OLAP All member.

alternate startup directory: A secondary location that stores files to be opened by an application when the application starts.

American National Standards Institute (ANSI) character set: A **character set** defined by a **code page** approved by the American National Standards Institute (ANSI). The term "ANSI" as used to signify Windows code pages is a historical reference and a misnomer that persists in the Windows community. The source of this misnomer stems from the fact that the Windows code page 1252 was originally based on an ANSI draft, which became International Organization for Standardization (ISO) Standard 8859-1 [[ISO/IEC-8859-1](#)]. In Windows, the ANSI character set can be any of the following code pages: 1252, 1250, 1251, 1253, 1254, 1255, 1256, 1257, 1258, 874, 932, 936, 949, or 950. For example, "ANSI application" is usually a reference to a non-**Unicode** or code-page-based application. Therefore, "ANSI character set" is often misused to refer to one of the character sets defined by a Windows code page that can be used as an active system code page; for example, character sets defined by code page 1252 or character sets defined by code page 950. Windows is now based on **Unicode**, so the use of ANSI character sets is strongly discouraged unless they are used to interoperate with legacy applications or legacy data.

ASCII: The American Standard Code for Information Interchange (ASCII) is an 8-bit character-encoding scheme based on the English alphabet. ASCII codes represent text in computers, communications equipment, and other devices that work with text. ASCII refers to a single 8-bit ASCII character or an array of 8-bit ASCII characters with the high bit of each character set to zero.

attribute hierarchy: A single-level **hierarchy** that uses only an attribute or a column from a source, back-end relational database as its hierarchy. An attribute hierarchy typically has the same name as the attribute and is always associated with the attribute on which it is based. An all-level member can optionally be enabled for an attribute hierarchy. See also OLAP hierarchy.

Augmented Backus-Naur Form (ABNF): A modified version of Backus-Naur Form (BNF), commonly used by Internet specifications. ABNF notation balances compactness and simplicity with reasonable representational power. ABNF differs from standard BNF in its definitions and uses of naming rules, repetition, alternatives, order-independence, and value ranges. For more information, see [[RFC5234](#)].

AutoComplete: A feature that suggests text automatically based on the first few characters that a user types.

AutoFilter: A mechanism that can be used to filter tabular data based on user-defined criteria such as values, strings, and formatting.

AutoFormat: A built-in set of complementary formatting options that can be applied to ranges of cells and other objects in a document.

AutoRecover: A feature that recovers document and application states in the event of a hardware or software failure.

AutoShow: A filter option that enables users to display a specified number of the top- or bottom-most items within a PivotTable field.

background color: A color against which characters, patterns, and graphics are displayed. See also **foreground color**.

beta: A pre-released version of a product that is sent to customers and partners for evaluation and feedback.

BIFF12: A binary file format that is used to save workbooks in Microsoft Office Excel 2007 and Microsoft Excel 2010.

BIFF2: A binary file format that is used by default to save worksheets in Microsoft Excel 2.1.

BIFF3: A binary file format that is used by default to save worksheets in Microsoft Excel 3.0 for Windows.

BIFF4: A binary file format that is used by default to save worksheets in Microsoft Excel 4.0 for Windows.

BIFF5: A binary file format that is used by default to save workbooks in Microsoft Excel 5.0 for Windows and Microsoft Excel for Windows 95.

BIFF8: A binary file format that is used to save workbooks in Microsoft Office Excel 2003 and earlier versions of Microsoft Excel.

big-endian: Multiple-byte values that are byte-ordered with the most significant byte stored in the memory location with the lowest address.

Binary Interchange File Format (BIFF): The binary file formats that are used to save Excel workbooks.

block-level formatting: A type of formatting that can be applied to a field or column in a table. It is applied to all existing records and automatically to new records.

border: A line that can be applied to the outer edge of a cell, shape, object, or chart element. A border can be variously formatted for style, color, and thickness.

border formatting: A set of properties that, as a whole, specify the appearance of a border, such as color, line style, and thickness.

border style: See **border formatting**.

bounding rectangle: A frame that encompasses an object. A bounding rectangle is not rotated and, therefore, always aligns along the x and y axes.

Briefcase: A system folder in Windows that is used to share and synchronize files between computers.

bubble size: A value that represents the diameter of a bubble in a bubble chart.

build identifier: An integer that identifies a build.

build number: A part of a sequential numbering system that is used to differentiate one version of a software product from another.

built-in name: A member of the group of defined names that are reserved for specific functionality.

ButtonPopup control: A type of Button control that displays a menu of related commands when activated.

calculation mode: A setting that determines whether the formulas in a worksheet are recalculated automatically or manually. See also automatic calculation mode and manual calculation mode.

camera picture: An image of a range of cells that is generated by using the camera tool. The image can be linked such that when the data in the source range changes, the image is updated automatically.

caption: One or more characters that can be used as a label for display purposes or as an identifier.

cascading style sheet (CSS): An extension to **HTML** that enables authors and users of HTML documents to attach style sheets to those documents, as described in [\[CSS-LEVEL1\]](#) and [\[CSS-LEVEL2\]](#). A style sheet includes typographical information about the appearance of a page, including the font for text on the page.

category: (1) A custom string that is used to group one or more documents.

(2) A subdivision of items into useful groups such as geographical regions. For example, categories that represent geographical regions could be North, South, East, and West.

category label: A label that appears on the horizontal (x) axis of a chart and identifies the categories of the source data.

cell: A box that is formed by the intersection of a row and a column in a worksheet or a table. A cell can contain numbers, strings, and formulas, and various formats can be applied to that data.

cell reference: A set of coordinates that a cell occupies on a worksheet. For example, "B3" is the reference of a cell that appears at the intersection of column "B" and row "3".

cell value: The text or numeric content of a cell, or the results of a formula. A cell value does not include a formula expression, cell formatting, or other metadata.

center-across-selection alignment: A formatting setting that centers cell content horizontally within a selected range of cells.

centered alignment: A formatting setting that specifies how content is positioned within the horizontal, vertical, or both horizontal and vertical space within a cell, object, or page. When centered, content is equidistant from the edges of the cell, object, or page.

character set: A mapping between the characters of a written language and the values that are used to represent those characters to a computer.

chart area: A region in a chart object that is used to position chart elements, render axes, and plot data.

chart sheet: A single logical container that is used to create and store charts in a workbook.

checksum: A value that is the summation of a byte stream. By comparing the checksums computed from a data item at two different times, one can quickly assess whether the data items are identical.

child: An object that is immediately below the current object in a hierarchy.

class identifier (CLSID): A **GUID** that identifies a software component; for instance, a DCOM object class or a COM class.

class module: A module that contains the definition for a new object. Each instance of a class creates a new object, and procedures that are defined in the module become properties and methods of the object.

client area: In an application, the display area that is used to create data, such as drawing or typing functions. The client area does not include toolbars, menus, or status bars.

code page: An ordered set of characters of a specific script in which a numerical index (code-point value) is associated with each character. Code pages are a means of providing support for **character sets** and keyboard layouts used in different countries. Devices such as the display and keyboard can be configured to use a specific code page and to switch from one code page (such as the United States) to another (such as Portugal) at the user's request.

collapsed outline state: A state in which the content that is nested within an outline is not displayed.

color palette: A collection of colors that is available to format text, shapes, cells, and chart elements.

color scale: A specific range of colors that is used to give additional meaning to data by assigning certain values to colors in the spectrum.

color scheme: A table of color values that enables colors to be referenced by an index value in the table instead of a color value. See also **color palette**.

column formula: A formula that is used in a calculated column.

column outline: A nested grouping of columns in a worksheet.

comment: An annotation that is associated with a cell, text, or other object to provide context-specific information or reviewer feedback.

compact axis: A state in which PivotTable members from different levels in a hierarchy are displayed in a single column.

Component Object Model (COM): An object-oriented programming model that defines how objects interact within a single process or between processes. In **COM**, clients have access to an object through interfaces implemented on the object. For more information, see [\[MS-DCOM\]](#).

conditional formatting: A mechanism that changes the appearance of a user interface element based on the evaluation of a rule or expression.

connection string: A series of arguments, delimited by a semicolon, that defines the location of a database and how to connect to it.

consolidation range: A range of source data that is used in a data consolidation process.

cryptographic service provider: An independent software module that performs authentication, encoding, and encryption services that Windows-based applications access through the CryptoAPI.

cube: A set of data that is organized and summarized into a multidimensional structure that is defined by a set of **dimensions (1)** and **measures**.

cube function: A function that is used to extract and display Online Analytical Processing (OLAP) data sets and values.

custom color palette: A set of user-defined colors that is available for formatting.

custom filter: A filter that contains preconfigured expressions in which users can optionally enter a string to filter data.

custom list: A user-defined list or enumeration that can be used to sort data in a worksheet.

custom rollup: An aggregation calculation that is customized for a dimension level, dimension member, or measure. A custom rollup contains a custom formula or operator, overrides the aggregate functions of a cube's measures, and is defined on a hierarchy.

custom view: A collection of display and print settings that users can name and save. Users can switch between custom views to change settings quickly.

Data Access Objects (DAO): A programming interface that can be used to access and manipulate database objects.

data bar: A graphical representation of cell content as a bar graph.

data consolidation: The process of combining tabular data from various worksheets into a single list.

data marker: A customizable symbol or shape that identifies a data point on a line, scatter, or radar chart. A data marker can be formatted with various sizes and colors.

data provider: A known data source that is specific to a target type and that provides data to a collector type.

data recovery: A process in which files are repaired through error correction or restored from backup media.

data region: A region of a table that encompasses the range of cells that contains the table records. A data region does not include the **header row**, insert row, or total row of a table.

data source: A database, web service, disk, file, or other collection of information from which data is queried or submitted. Supported data sources vary based on application and data provider.

data table: (1) A range of cells that is designated to perform what-if analysis for formulas, based on various input values.

(2) A grid that can be added to some charts and contains the numeric data that is plotted in the chart.

data validation: The process of testing the accuracy of data; a set of rules that specify the type and range of data that users can enter.

date system: A method of calculating calendar dates and times.

DDE link: A connection between a **Dynamic Data Exchange (DDE)** source document and a destination document.

DDE server: An application that responds to a **Dynamic Data Exchange (DDE)** request from a DDE client application.

DDE topic: A general classification of information about a **Dynamic Data Exchange (DDE)** server within which multiple, specific data items related to the topic can be exchanged.

defined name: A word or string of characters in a formula that represents a cell, range of cells, formula, or constant value.

descending order: A sort order in which text strings are arranged in reverse alphabetical order, numerical values are arranged from largest to smallest, and dates and times are arranged from newest to oldest.

diagonal-down: A cell **border formatting** that displays a line diagonally from the top left corner of a cell to the bottom right corner.

diagonal-up: A cell **border formatting** that displays a line diagonally from the bottom left corner of a cell to the top right corner.

dialog sheet: A single logical container that is used to create a custom dialog box.

dimension: (1) A structural attribute of a cube, which is an organized hierarchy of categories (levels) that describe data in a fact table. These categories typically describe a similar set of members upon which the user bases an analysis.

(2) A categorization of data in rows or columns in an Excel worksheet.

display folder: A folder into which attributes, measures, calculated members, and key performance indicators can be organized to facilitate browsing.

display units: An axis-formatting option that determines how numeric units are displayed on a value axis.

distributed alignment: A formatting setting that spreads text evenly, both vertically and horizontally, between the edges of a cell, object, or page. Distributed alignment is used primarily with East Asian languages. See also **justify distributed**.

document library: A type of list that is a container for documents and folders.

double accounting: An underline style that places two lines beneath the formatted text. Double accounting is frequently used to indicate totals.

down bar: See **up-down bar**.

drawing: A collection of drawing objects, such as shapes, curves, or WordArt, that are viewed together as a single image.

drawing group: A collection of images that are designated by the user as a single group of images and manipulated as a single **drawing object**.

drawing object: A shape, curve, line, WordArt, or other type of graphical object that can be inserted into a document.

drillthrough: A query that is used to retrieve individual records that were used to calculate an aggregate value.

drop lines: A set of supplemental lines on an area chart or a line chart. Drop lines increase the legibility of a chart by connecting each data point in a series to the category axis.

Dynamic Data Exchange (DDE): An inter-process communication method that is featured in Windows. DDE allows two or more applications that are running simultaneously to exchange data and commands.

embedded object: An object that is created by using one application and is hosted in a document that was created by using another application. Embedding an object, rather than inserting or pasting it, ensures that the object retains its original format. Users can double-click an embedded object and edit it with the toolbars and menus from the application that was used to create it. See also **Object Linking and Embedding (OLE)**.

Excel Linked Library (XLL): A Dynamic Link Library (DLL) that is authored to function as an **add-in** for Microsoft Excel.

Excel macro (XLM): A programming language that provides development capability in Microsoft Excel. XLM was superseded by Microsoft Visual Basic for Applications (VBA).

expand/collapse button: A user interface control that is used to determine which hierarchical level is displayed in an outline, or in row and column groupings.

expression: A combination of operators, symbols, constants, literal values, functions, names of fields or columns, controls, and properties that evaluates to a single value.

external data: Data that is stored in a repository outside a workbook.

external link: A reference to a cell, range, defined name, or other object in another worksheet or workbook.

fill: A color, pattern, or other attribute that is used to format the background of a cell, shape, or chart element. See also **fill color** and **fill pattern**.

fill alignment: A setting that repeats a cell value to fill the horizontal space of a cell. If the cell value exceeds the horizontal width of the cell, the value is truncated.

fill color: A color that is used to fill the background of a cell, shape, or chart element.

fill pattern: A repetitive design that users can add to the background of a cell, shape, or chart element.

filter: A mechanism by which a set of data is scoped to display only those entries that meet specified logical criteria.

filtering state: A setting that indicates whether a filter value or filter date value is included as part of the criteria that is used to define the filter for an **AutoFilter**.

fit to page: A printing option that scales a document to print on a specified number of pages.

floating-point number: A number that is represented by a mantissa and an exponent according to a given base. The mantissa is typically a value between "0" and "1". To find the value of a floating-point number, the base is raised to the power of the exponent, and the mantissa is multiplied by the result.

floor: An extension of the horizontal axis, or the area created by the inclusion of the z axis, in a 3-D chart to create a three-dimensional effect. See also **wall**.

folder: A file system construct. File systems organize a volume's data by providing a hierarchy of objects, which are referred to as folders or directories, that contain files and can also contain other folders.

followed hyperlink: A hyperlink that has been activated by a user.

font: An object that defines the graphic design, or formatting, of a collection of numbers, symbols, and letters. A font specifies the style (such as bold and strikeout), size, family (a typeface such as Times New Roman), and other qualities to describe how the collection is drawn.

font face weight: A value that specifies the thickness of a font.

font family: A set of fonts that all have common stroke width and serif characteristics. For example, Times Roman and Times Roman Italic are members of the same font family.

font scaling: A process of resizing a proportionally-spaced font.

font scheme: A combination of complementary fonts in a **theme**.

forecast: The process of projecting values forward or backward in a series, based on trends in existing data.

foreground color: A color that is used to display text, patterns, and other objects that appear in front of or on top of the **background color**.

form: A structured document with controls and spaces that are reserved for entering and displaying information. Forms can contain special coding for actions such as submitting and querying data.

format string: A string that contains the number formatting information to apply to data, such as decimal position, percentage indicator, or currency symbol.

formatting run: A set of formatting properties that are applied to a **text run**.

formula bar: A user interface element that appears at the top of a worksheet and is used to display and edit cell content.

formula error checking: A mechanism that identifies invalid worksheet data, formulas, or formatting and then proposes corrections.

friendly name: A name for a user or object that can be read and understood easily by a human.

frozen: See **frozen panes**.

frozen panes: Portions of a worksheet that remain static and do not scroll when the worksheet is displayed in split pane view. See also **split pane**.

full screen view: A document view that expands the display of a document to fill the computer screen. The view hides menus, toolbars, and taskbars.

function: A code module that takes a value as input, performs an operation, and returns the results to a worksheet.

function category: A group of worksheet functions that are part of the same broad usage area, such as Finance or Statistical. A function category can be built-in or user-defined.

general alignment: A default formatting setting for the horizontal alignment of cell content in a worksheet. Text is positioned to the left and numbers are positioned to the right.

globally unique identifier (GUID): A term used interchangeably with universally unique identifier (UUID) in Microsoft protocol technical documents (TDs). Interchanging the usage of these terms does not imply or require a specific algorithm or mechanism to generate the value. Specifically, the use of this term does not imply or require that the algorithms described in [\[RFC4122\]](#) or [\[C706\]](#) must be used for generating the **GUID**. See also universally unique identifier (UUID).

gradient fill: A type of fill that applies gradient formatting to the background of a cell or an object.

gradient stop: A marker on a gradient spectrum that denotes where a specific color is introduced in gradient formatting.

grand total: An aggregation of all of the field subtotals in a PivotTable report.

graph object: An object that represents a chart and the datasheet that contains the data for that chart.

GraphicDropDown control: A type of DropDown control that can display custom graphics in a list of options.

gridline: A line that is drawn on a worksheet or table for use as a visual aid to distinguish between cells.

gutter: An area above a column heading and to the left of a row heading. A gutter typically displays outline symbols that are used to expand and collapse groups of cells.

hash: A fixed-size result that is obtained by applying a one-way mathematical function, which is sometimes referred to as a hash algorithm, to an arbitrary amount of data. If the input data changes, the hash also changes. The hash can be used in many operations, including authentication and digital signing.

header row: A row in a table, typically the first row, that contains labels for columns in the table.

hidden: A condition of an object that prevents it from being displayed in rendered output.

hidden cell: A cell that does not appear in a worksheet view because it is contained within a **hidden row** or a **hidden column**.

hidden column: A column that does not appear in a worksheet view because its width is set to 0 (zero). A column can be hidden if an outline is collapsed.

hidden protection: A cell protection property that prevents formulas, but not values, from appearing in a cell when a worksheet is **protected**.

hidden row: A row that does not appear in a worksheet view because its height is set to "0" (zero). A row can be hidden if the data is filtered or an outline is collapsed.

hierarchy: A logical tree structure that organizes the members of a dimension such that each member has one parent member and zero or more child members.

high-low lines: Supplemental lines that are added to a line chart and connect the maximum data points of one series with the minimum data points of another series for each **category (2)**. High-low lines are typically used on stock charts.

horizontal alignment: A formatting setting that specifies how content is positioned within the horizontal space of a cell, object, or page. Content can be aligned along the left or right edge, or distributed evenly across the horizontal space.

hyperlink: A relationship between two anchors, as described in [\[RFC1866\]](#).

Hypertext Markup Language (HTML): An application of the Standard Generalized Markup Language (SGML) that uses tags to mark elements in a document, as described in [\[HTML\]](#).

icon: A graphical image used to supplement alphanumeric text in the visual identification of an object on a computer monitor. **Icons** are typically small, relative to the size of the area on which they are displayed.

icon set: A collection of icons that can be used to comment and classify data into categories.

indentation level: A measure of the distance between the position of content that is in a cell and the logical left side of the cell. An indentation level is equal to three spaces.

Information Rights Management (IRM): A technology that provides persistent protection to digital data by using encryption, certificates, and authentication. Authorized recipients or users acquire a license to gain access to the protected files according to the rights or business rules that are set by the content owner.

ink: A process of entering text in handwritten form. Instead of converting handwritten text to typed text, ink is converted to an object and displayed exactly as it was written.

inner rectangle: In a cell that is formatted with a rectangular gradient, a rectangle that is formed by the leftmost, rightmost, topmost, and bottommost lines of pixels in which the initial color of the gradient is completely dissipated. See also **rectangular gradient**.

input cell: A cell in which each input value from a data table is substituted.

input language: A pairing of input language and input method. The pairing determines what language is currently being entered and how. The input language is usually determined by the keyboard language that is currently active in the operating system. Users can install keyboard layouts and Input Method Editors (IMEs) for several languages, and then switch between them at appropriate times to indicate the input language.

Input Method Editor (IME): An application that is used to enter characters in written Asian languages by using a standard 101-key keyboard. An IME consists of both an engine that converts keystrokes into phonetic and ideographic characters and a dictionary of commonly used ideographic words.

insert row: A placeholder row at the bottom of a table. It is used to enter new records.

international macro sheet: A macro sheet that displays English function names and operates with U.S. English locale settings, regardless of product locale, user locale, or system locale.

iterative calculation: A **calculation mode** in which calculations are performed until a specific numeric condition is met or a maximum number of iterations is reached.

justify distributed: A special, distributed-alignment setting that evenly distributes the last line of text in a cell. The setting is primarily used for East Asian languages. See also **distributed alignment**.

key performance indicator (KPI): A predefined measure that is used to track performance against a strategic goal, objective, plan, initiative, or business process. A visual cue is frequently used to communicate performance against the measure.

language code identifier (LCID): A 32-bit number that identifies the user interface human language dialect or variation that is supported by an application or a client computer.

leader line: A line that connects a data label to its corresponding data point. The primary purpose of a leader line is to increase legibility.

left-to-right: A reading order in which characters in words are read from left to right, and words are read from left to right in sentences.

legend entry: An item in a chart legend that identifies a single series or **category (2)**.

legend key: A symbol that is associated with a legend entry.

library directory: A directory in which Microsoft Excel **add-ins** are installed.

license key: An array of bytes that enables access to a control according to the usage policies for that control.

line style: A style, including width and dash type, that is applied to and alters the appearance of a line or **border**.

linear gradient: A type of gradient fill in which the color of a cell or other object gradually changes horizontally, vertically, or diagonally from one edge of the object to the other.

linked object: An object that is inserted into a document and continues to exist in a separate source file. If the object in the source file changes, the object in the document is updated automatically to reflect those changes.

list: A container within a SharePoint site that stores list items. A list has a customizable schema that is composed of one or more fields.

list view: A named collection of settings for querying and displaying items in a SharePoint list. There are two types of views: Personal, which can be used only by the user who created the view; and Public, which can be used by all users who have permission to access to the site.

little-endian: Multiple-byte values that are byte-ordered with the least significant byte stored in the memory location with the lowest address.

local name: A defined name whose scope is limited to a specific sheet instead of the entire workbook.

locale: A collection of rules and data that are specific to a language and a geographical area. A locale can include information about sorting rules, date and time formatting, numeric and monetary conventions, and character classification.

localization: The process of adapting an application or documentation, including text and non-text elements, to meet the language, cultural, and political expectations and requirements of a specific geographic country or region.

locked: The condition of a cell, worksheet, or other object that restricts edits or modifications to it by users.

locked protection: A cell-protection property that restricts the editing of cell content when a worksheet is **protected**.

logical left: A position that is relative to the language orientation of a document. Logical left means left, except in a right-to-left language where it means right. Also referred to as leading edge.

logical right: A position that is relative to the language orientation of a document. Logical right means right, except in a right-to-left language where it means left. Also referred to as trailing edge.

logical top-left: A position that is relative to the language orientation of a document. Logical top-left is the upper-left corner of a range or object when in left-to-right mode. It is the upper-right corner when in right-to-left mode.

logical top-right: A position that is relative to the language orientation of a document. Logical top-right is the upper-right corner of a range or object when in left-to-right mode. It is the upper-left corner when in right-to-left mode.

long file name: A folder or file name that is longer than the 8.3 file name standard, which permits as many as eight characters followed by a period and a file name extension of three characters.

macro: A set of instructions that are recorded or written, and then typically saved to a file. When a macro is run, all of the instructions are performed automatically.

macro sheet: A single, logical container that is used to store and run Excel 4.0 macro formulas.

major gridline: A horizontal or vertical line that is in the plot area of a chart and corresponds to the major scaling unit on an axis.

major scheme: A font scheme that is used for primary text elements, such as headings and titles, in a **theme**.

major tick mark: A tick mark that corresponds to a major scaling unit on an axis.

Mandarin phonetic symbols: A phonetic system for transcribing Chinese through the use of an alphabet that includes characters for all possible sounds in the spoken Mandarin language.

manifest: A file that stores metadata about an expansion pack, such as the name of the expansion pack, the files and resources that are included in the expansion pack, and the dependencies that it has on other files and components.

MD5: A one-way, 128-bit hashing scheme that was developed by RSA Data Security, Inc., as described in [\[RFC1321\]](#).

MDX unique name: A unique identifier for a multidimensional expression (MDX) member or value in a given Online Analytical Processing (OLAP) cube, for example "[Customer].[Customer Geography].[Country].&[Australia]".

measure: In a cube, a set of values that are typically numeric and are based on a column in the fact table of the cube. Measures are the central values that are aggregated and analyzed.

measure group: A collection of related **measures** in a **cube** that derive from a single fact table, typically in a data source view.

member: (1) An identity that belongs to a shared space.

(2) See **OLAP member**.

member property: An attribute on a data item within a specific dimension in an Online Analytical Processing (OLAP) database.

merge conflict: A problem that occurs if two users are editing the same cell or other type of object in a workbook while changes are being merged in a shared workbook.

merged cell: A single cell that is created by combining two or more adjacent cells.

messaging system service provider: A business that supplies email and other messaging services to individuals, businesses, and other organizations.

metafile: A file that stores an image as graphical objects, such as lines, circles, and polygons, instead of pixels. A metafile preserves an image more accurately than pixels when an image is resized.

Microsoft Office Web Components: A set of controls that can be used to create data analysis and reporting solutions.

minimal save: A process that saves only critical workbook data to disk when errors are detected during a file save operation.

minor gridline: A horizontal or vertical line that is in the plot area of a chart and corresponds to the minor scaling unit on an axis.

minor scheme: A font scheme that is used for secondary text elements, such as body text, in a **theme**.

minor tick mark: A tick mark that corresponds to a minor scaling unit on an axis.

module: A collection of routines and data structures that performs a specific task or implements a specific abstract data type. Modules usually consist of two parts, a module header and a module body. A module header is a set of name/value attribute pairs that specify the linguistic characteristics of the module. A module body is the VBA source code, a set of declarations followed by procedures. VBA supports two types of modules, procedural modules and class modules.

moving average: A type of trendline that is calculated based on the most recent period of data points in a series.

Multidimensional Expressions (MDX): A syntax that is used for defining multidimensional objects, and for querying and manipulating multidimensional data.

named range: See **defined name**.

narrow katakana: A non-cursive **character set** that is used to write non-Japanese words phonetically in Japanese. Narrow katakana characters are represented with a single byte. Also referred to as half-width katakana.

natural language formula: A syntax for referring to tabular data in formulas by using column and row labels instead of cell references.

natural language label: A value of a cell or cells that identifies a range in a natural language formula. A label is typically the same as a column or row header in tabular data.

ninched: A condition in which a group of selected cells or objects do not share a specific property. For example, if a selection has three cells and only two of the cells share the same color formatting, the color formatting of the selection is in a ninched state.

non-contiguous range: A selected **range** that includes non-adjacent cells.

Normal view: A document view that displays text formatting and a simplified page layout of a document. The Normal view hides some layout elements such as the header and footer. Referred to as Draft view in Microsoft Office Word 2007 and Microsoft Word 2010.

number format: A property of a cell or other type of object that determines how numerical data is displayed or interpreted. For example, a currency number format affixes the proper currency symbol to the number.

obfuscation key: A secret shared key combined with a cryptographic hash function that is intended to prevent a reversal of an encoding process. See also **XOR obfuscation**.

Object Linking and Embedding (OLE): A technology for transferring and sharing information between applications by inserting a file or part of a file into a compound document. The inserted file can be either embedded or linked. See also **embedded object** and **linked object**.

object model: A collection of object-oriented APIs that represent data structures and are designed to promote software interoperability.

OCXDropDown control: A type of DropDown control that displays a list of the ActiveX controls that are available within that application.

Office data connection (ODC) file: A file that stores information about a connection to a data source, such as an Access database, worksheet, or text file. This file facilitates data source administration.

OLAP calculated member: An **OLAP member** whose value is calculated at run time.

OLAP cube: A data structure that aggregates **Online Analytical Processing (OLAP)** measures by **OLAP levels** and **OLAP hierarchies**. An OLAP cube combines several OLAP hierarchies, such as time, geography, and product lines, with OLAP measures, such as sales or inventory figures.

OLAP hierarchy: An **attribute hierarchy** or a user-defined hierarchy in a data structure. By default, each dimension attribute has an attribute hierarchy. A user-defined hierarchy is a set of related attribute hierarchies that is used to facilitate browsing an **OLAP cube**.

OLAP KPI: See **key performance indicator (KPI)**.

OLAP level: Within an **OLAP hierarchy**, a set of data that is organized into a lower or higher level of detail, such as Year, Quarter, Month, and Day levels in a Time hierarchy.

OLAP measure: A set of numeric values in an **OLAP cube** that is used in aggregation and analysis.

OLAP measure group: A collection of related **OLAP measures** in an **OLAP cube**. An OLAP cube can contain multiple measure groups.

OLAP member: An item that is in an **OLAP level**. For example, a Canada member in a Country level of a Geography hierarchy.

OLAP member property: A relationship between two **OLAP hierarchies**, such as a Population member property of a Country member.

OLAP named set: A collection of **OLAP tuples** that have the same dimensionality. Also referred to as OLAP set.

OLAP set: A collection of **OLAP tuples** with the same dimensionality. Also referred to as OLAP named set.

OLAP tuple: An ordered collection of members that are from different dimensions of an **OLAP cube**. A single member is a special case of a tuple.

OLE compound file: A form of structured storage, as described in [\[MS-CFB\]](#). A compound file allows independent storages and streams to exist within a single file.

OLE DB: A set of interfaces that are based on the Component Object Model (COM) programming model and expose data from a variety of sources. These interfaces support the amount of Database Management System (DBMS) functionality that is appropriate for a data store and they enable a data store to share data.

OLE link: A connection between an **Object Linking and Embedding (OLE)** object and its OLE server. See also **DDE link**.

OLE object: An object that supports the **Object Linking and Embedding (OLE)** protocol.

OLE server: An application or DLL that supplies a linked or embedded OLE object to another application.

OLE2: See **Object Linking and Embedding (OLE)**.

one-variable data table: A data table that consists of only one input cell, which is either a row input cell or a column input cell.

Online Analytical Processing (OLAP): A technology that uses multidimensional structures to provide access to data for analysis. The source data for OLAP is stored in data warehouses in a relational database. See also **cube**.

Open Database Connectivity (ODBC): A standard software API method for accessing data that is stored in a variety of proprietary personal computer, minicomputer, and mainframe databases. It is an implementation of [ISO/IEC9075-3:2008](#) and provides extensions to that standard.

outline: A nested grouping of rows or columns that are in a worksheet.

outline effect: A formatting effect in which a line is placed around the edge of a shape or around each character in a text string.

outline level: The number of levels that a task is indented from the top level of an outline; the order associated with an outline.

outline state: A setting that specifies whether an outline is currently outline expanded or outline collapsed.

out-of-memory: A state of a computer or application when it halts because all of the available volatile memory has been allocated and none is currently available for reallocation.

page break: A divider that breaks a worksheet into separate pages for printing. Page breaks are inserted automatically based on the paper size, margin settings, scaling options, and the positions of any page breaks that are inserted manually.

Page Break Preview view: A worksheet view that displays the areas to be printed and the locations of page breaks.

Page Layout view: A sheet view that displays a sheet as it would appear on a printed page, including margins, header and footer elements, and pagination.

palette color: A specific color among those that are available on the active color palette.

pane: A portion of a software window that has a distinct function and is bounded by and separated from other portions of the window by vertical or horizontal bars.

Pane control: A type of toolbar control that hosts a window within itself. The hosted window is not constrained by the layout and control type options of a basic toolbar or a menu toolbar.

parameterized query: A query that contains parameters. It applies to Open Database Connectivity (ODBC) and web queries. For example, a web query that retrieves stock quotes from a webpage can prompt users for a parameter, such as a stock symbol.

phonetic guide: A set of supplemental phonetic symbols that appears above text in Japanese and other East Asian languages. A phonetic guide is displayed automatically and can be edited by the user.

phonetic information: A series of characters that appear above text in a cell and provide information that helps users pronounce the text.

phonetic string: A series of characters that appear above a string and provide information that helps users pronounce the string. Phonetic strings are typically used in East Asian languages.

phonetic text run: A series of characters that are within a **phonetic string**.

PivotChart filter pane: A user interface element that displays a list of active fields in a PivotChart view and is used to apply filters to those fields.

PivotTable field list: A user interface element that displays a list of all of the fields in a PivotTable report. It can be used to populate a PivotTable report and to manipulate the fields.

pixel: A discrete unit of display on a computer display device.

placeholder: A character or symbol that is used in place of an actual value, text, or object. The actual value that the placeholder represents is unknown or unavailable at the current time, or is not displayed for security reasons.

plot area: A portion of a chart area that contains the plotted data and axes.

point: A unit of measurement for fonts and spacing. A point is equal to 1/72 of an inch.

Popup control: A built-in or custom control on a menu bar or toolbar that displays a menu of related commands when clicked.

post method: A method of submitting form data in the header of an HTTP request.

precision as displayed: A calculation setting that permanently changes stored values in cells from full precision (15 digits) to the currently displayed format, including the number of decimal places.

primary pie: The main chart in a bar of pie or pie of pie chart. A primary pie chart has one pie slice (data point) that is a grouping of data points.

print area: A collection of one or more ranges of cells that are designated to be printed. If a worksheet includes a print area, only the content inside the print area is printed.

print settings: The settings that specify how a file is printed in a specific print job, such as duplex or landscape orientation. Printer settings are settings that can differ from printer to printer but apply to every print job of a given printer. Print settings are values that typically vary between print jobs.

print titles: The rows or columns that appear on each page when a page is printed. Print titles are typically used to print column headers above tabular data that spans several printed pages.

ProgID: An identifier that is used by the Windows registry to uniquely identify an object and is in the form OLEServerName.ObjectName, for example, "Excel.Sheet" or "PowerPoint.Slide."

property stream: A series of object properties that is used in processes such as checksum calculations.

protected: A property that is applied manually to a file or a portion of a file, with or without a password, and that helps prevent users from accidentally or deliberately changing, moving, or deleting data.

protection: A mechanism that helps restrict users from making unwanted changes to the data or structure of a workbook.

published: A condition of portions of a workbook that are marked as being available to the user when that workbook is processed by a protocol server.

published item: A specific named object that is in a published workbook.

query: A formalized instruction to a data source to either extract data or perform a specified action. A query can be in the form of a query expression, a method-based query, or a combination of the two. The data source can be in different forms, such as a relational database, XML document, or in-memory object. See also search query.

query table: A two-dimensional table that presents data from an external data source.

R1C1: A **reference style** in which each row and each column has a numeric heading that is numbered sequentially from top to bottom and left to right, respectively. "R" stands for row and "C" stands for column.

range: An addressable region that is in a workbook. A range typically consists of zero or more cells and represents a single, contiguous rectangle of cells on a single sheet.

reading order: The positioning of characters in words and the positioning of words in sentences. This can be left-to-right or right-to-left.

read-only recommended: A file sharing property that displays an alert when a file is being opened. The text of the alert recommends that the user open the file with read-only permission.

real-time data (RTD): Data that is pushed into a worksheet from an **RTD server** and is updated continually. Real-time data is frequently used to track stock prices or inventory levels in real time.

recalculate: The process of computing a value in a workbook by initiating a calculation repeatedly.

reconnect condition: A condition that specifies whether to connect to a database again after a connection expires.

rectangular gradient: A type of gradient fill in which the color of a cell or other object gradually changes with each successive inner rectangle of pixels.

red-green-blue-alpha (RGBA): A color model that describes color information in terms of the red (R), green (G), blue (B), and alpha (A) intensities that comprise a color.

reference style: A system that is used in formulas to specify cells or ranges of cells. A reference style specifies a cell in a two-dimensional table by identifying the row and column that contain that cell or range of cells.

refresh: A process that retrieves values from a data source and populates a workbook with those values.

regional settings: See locale settings.

relative reference: A reference to a location on a sheet that is relative to the cell that contains the reference. A relative reference can be stored as a cell reference or as an offset.

relative security descriptor: A security descriptor that contains all associated security information in a contiguous block of memory.

result cell: A cell that contains the results of the calculation of changing cells in a scenario.

revision: A change in a document, file, or other object.

revision history: A list of data that describes document updates, such as when and by whom a document was modified.

revision record: Any of the records in the revision stream of a **shared workbook** that stores user edits to the workbook and other tracked information.

right-to-left: A reading and display order that is optimized for right-to-left languages.

routing slip: Information that specifies how a document is to be distributed from a document originator and processed by one or more recipients. It also specifies subject and message body text that is associated with the document routing process and routing status or workflow information.

routing stage: The current status of a document with a routing slip.

row outline: A mechanism for grouping and nesting the rows in a worksheet.

RTD server: A Component Object Model (COM) Automation server that is used by the real-time data (RTD) function to retrieve data in real time. The RTD server can exist as an ActiveX DLL or as an executable (.exe) file that runs on the same local computer or on a remote server.

RTD topic: A discrete combination of parameters that is used to request data from a real-time data (RTD) server.

ruler: A user interface element that enables users to adjust page margins and to measure and align objects in a document.

safe load: A process of loading a file in which additional error checking is performed and various corruption patterns in the file are detected and repaired.

scenario: A named set of input values (changing cells) that can be substituted in a worksheet model.

Scenario Manager: A process for creating and managing different sets of input values for calculation models in a worksheet.

secondary bar/pie: A secondary chart in a bar of pie or pie of pie chart that displays the detailed data of the grouped data point in the primary pie chart. The secondary bar/pie chart takes the form of a stacked bar chart or a pie chart that is connected to the primary pie chart with series lines.

security descriptor: A data structure containing the security information associated with a securable object. A **security descriptor** identifies an object's owner by its security identifier (SID). If access control is configured for the object, its **security descriptor** contains a discretionary access control list (DACL) with SIDs for the security principals who are allowed or denied access. Applications use this structure to set and query an object's security status. The **security descriptor** is used to guard access to an object as well as to control which type of auditing takes place when the object is accessed. The **security descriptor** format is specified in [\[MS-DTYP\]](#) section 2.4.6; a string representation of **security descriptors**, called SDDL, is specified in [\[MS-DTYP\]](#) section 2.5.1.

selected: The condition of a set of items that has focus in a workbook.

selection: An item or set of items, such as cells, shapes, objects, and chart elements, that has focus in a document.

series line: A supplemental line on a stacked column, stacked bar, pie of pie, or bar of pie chart that connects each data point in a series with the next data point to increase legibility.

server name: The name of a server, as specified in the operating system settings for that server.

shade: A color that is mixed with black. A 10-percent shade is one part of the original color and nine parts black.

shadow effect: A formatting effect that makes a font or object appear to be elevated from the page or screen surface, and therefore casts a shadow.

shape: A collection of qualifiers, such as names, and quantifiers, such as coordinates, that is used to represent a geometric object. A shape can be contained in a document, file structure, run-time structure, or other medium.

shared workbook: A workbook that is configured to enable multiple users on a network to view and make changes to it at the same time. Each user who saves the workbook sees the changes that are made by other users.

sheet: (1) A part of an Excel workbook. There are four types of sheets: **worksheet**, **macro sheet**, **dialog sheet**, and **chart sheet**. Multiple sheets are stored together within a workbook.

(2) A worksheet. The term sheet frequently refers to a worksheet because worksheets are the most common type of sheet.

sheet stream: See **stream** and document stream.

sheet tab: A control that is used to select a sheet.

sheet view: A collection of display settings, such as which cells are shown, and the zoom level for a sheet window.

shrink to fit: The process of adjusting the font size of text in a cell to fit the current height and width of the cell.

single accounting: An underline style that places one line beneath the text. Single accounting can be used to indicate subtotals.

single sign-on (SSO) identifier: A string that represents the definition of user credentials that permit a user to access a network. See also single sign-on (SSO).

smart document: A file that is programmed to assist the user as the user creates or updates the document. Several types of files, such as forms and templates, can also function as smart documents.

smart tag: A feature that adds the ability to recognize and label specific data types, such as people's names, within a document and displays an action button that enables users to perform common tasks for that data type.

smart tag actions button: A user interface control that displays a menu of actions that are associated with a specific smart tag.

smart tag indicator: A triangular symbol that appears in the bottom right corner of a cell and indicates that the cell contains a smart tag.

sort: A process that arranges cells in ascending or descending order, based on cell content.

sort condition: A condition that determines how to sort cells in a range.

sort order: A specific arrangement of cells that is based on cell content. The order can be ascending or descending.

sort range: A range of cells that will be or has been sorted.

source data: The data that is used as the basis for charts, PivotTable reports, and other data visualization features.

split pane: A pane that consists of two or more discrete areas of a window. Each area displays content and scrolls independently from other areas of the window. See also **frozen panes**.

SplitButtonMRUPopup control: A type of **SplitButtonPopup control** whose icon changes to reflect the command that the user most recently selected from the menu that is displayed by that button.

SplitButtonPopup control: A type of Button control that performs an action when clicked, and can also display a menu of related commands when the user clicks a drop-down arrow that appears on the button.

SplitDropDown control: A type of Button control that performs a default action when clicked, and can also expand to display a list of other possible actions when the user clicks a drop-down arrow that appears on the button.

startup directory: The directory from which an application opens data files when the application starts.

storage: An element of a compound file that is a unit of containment for one or more storages and streams, analogous to directories in a file system, as described in [MS-CFB].

stream: An element of a compound file, as described in [MS-CFB]. A stream contains a sequence of bytes that can be read from or written to by an application, and they can exist only in storages.

strikethrough formatting: A formatting option in which characters are crossed out by horizontal line.

stripe band: One or more adjacent columns or rows that are in a table and have the same stripe formatting.

stroke order: A sort order that arranges items in a sort range according to the number of strokes that is used to write each glyph. Stroke order is used when sorting text that is written in some East Asian languages.

Structured Query Language (SQL): A database query and programming language that is widely used for accessing, querying, updating, and managing data in relational database systems.

style: A set of formatting options that is applied to text, tables, charts, and other objects in a document.

subtotal column: A column that uses a summary or subtotal function to display the total of detail items in a PivotTable field.

table: A list that is defined in a workbook.

template: A file that contains pre-defined formatting including layout, text and graphics. It serves as the basis for new documents that have a similar look or purpose. See also form template (Microsoft InfoPath) and site template (SharePoint Products and Technologies).

text importation: A process that incorporates textual data into a workbook, either by opening a text file or through an external link.

text query: A query that is used to import data from text files.

text run: A string of characters that represents a discrete span of text with the same formatting properties.

text style: A formatting option, such as bold or italic, that can be applied to a font.

theme: A set of unified design elements, such as colors, fonts, graphics, and styles, that define the appearance of a website, document, or data visualization.

time hierarchy: A specialized Online Analytical Processing (OLAP) hierarchy that can be organized into lower and higher levels of detail, such as Year, Quarter, Month, and Day.

toolbar control: An object that appears on a toolbar and enables user interaction or input, typically to initiate an action, display information, or set values.

toolbar view: A visual state of a toolbar that depends on the current state of the application. Valid toolbar views are docked, floating, and not visible.

tooltip: A window displaying text that is created when the mouse is moved over a window or notification icon.

top N filter: A filter that matches the top or bottom N items or N% of items in a specified column.

total row: A row in a list or table that provides a selection of aggregate functions that are useful for working with numerical data.

transfer protocol: A protocol that governs the transfer of files, Internet messages, and webpages between networked computers. On the Open Systems Interconnection (OSI) Basic Reference Model, these are application layer protocols. Examples of transfer protocols are Hypertext Transfer Protocol (HTTP), Simple Mail Transfer Protocol (SMTP), and File Transfer Protocol (FTP).

transition formula entry: A worksheet option that enables users to enter formulas that use IBM Lotus 1-2-3 syntax.

transition formula evaluation: A setting that enables formulas in a worksheet to be calculated in a manner that is consistent with IBM Lotus 1-2-3.

trendline: A line that is added to a chart to show the trend of multiple data points in a series. A trendline is used to facilitate regression analysis.

tuple: An ordered grouping of members from different dimensions or hierarchies. A single member is a special case of a tuple and can be used as an expression. Every hierarchy does not have to be represented in a tuple.

twip: A unit of measurement that is used in typesetting and desktop publishing. It equals one-twentieth of a printer's point, or 1/1440 of an inch.

two-variable data table: A data table that consists of two input cells, a row input cell and a column input cell.

type library: A binary file that describes the methods, properties, and data structure of a component.

UNC volume: A storage device that is accessible by network protocols and addressed in the standard Universal Naming Convention format, for example, "\\Server Name\Share Name".

unfrozen pane: A portion of a worksheet that continues to scroll and function normally in split pane view. See also **frozen pane**.

Unicode: A character encoding standard developed by the Unicode Consortium that represents almost all of the written languages of the world. The **Unicode** standard [\[UNICODE5.0.0/2007\]](https://www.unicode.org/versions/Unicode5.0.0/)

provides three forms (UTF-8, UTF-16, and UTF-32) and seven schemes (UTF-8, UTF-16, UTF-16 BE, UTF-16 LE, UTF-32, UTF-32 LE, and UTF-32 BE).

Uniform Resource Identifier (URI): A string that identifies a resource. The URI is an addressing mechanism defined in Internet Engineering Task Force (IETF) Uniform Resource Identifier (URI): Generic Syntax [\[RFC3986\]](#).

Uniform Resource Locator (URL): A string of characters in a standardized format that identifies a document or resource on the World Wide Web. The format is as specified in [\[RFC1738\]](#).

up bar: See **up-down bar**.

up-down bar: A vertical bar that highlights the difference between data points in a line chart that contains more than one data series.

user name: A unique name that identifies a specific user account. The user name of an account is unique among the other group names and user names within its own domain or workgroup.

user-defined function (UDF): A function that is coded in a VBA module, macro sheet, **add-in**, or **Excel Linked Library (XLL)**. A UDF can be used in formulas to return values to a worksheet, similar to built-in functions.

VBA project: A collection of the modules, class modules, and user forms that are needed to create an application. Modules, class modules, and user forms can be imported into and exported from a project.

Vector Markup Language (VML): A system of marking up or tagging two-dimensional vector graphics for publication on the World Wide Web. VML graphics are scalable and editable, and typically require less disk space and less time to download.

vertical alignment: A formatting setting that specifies how content is positioned within the vertical space of a cell, object, or page. Content can be aligned along the top or bottom edge, or distributed evenly across the vertical space.

visible: A condition of an object that allows it to be displayed in rendered output.

Visual Basic for Applications (VBA): A macro-based programming language that derives from Microsoft Visual Basic and can be used to customize and extend an application. Unlike Visual Basic, VBA code and macros can be run only from within a host application that supports VBA.

volatile: A condition of a formula in which the formula is calculated every time the workbook is calculated. This is unlike a non-volatile formula, which is calculated only when dependent values are changed.

wall: An extension of the background of a 3-D chart to create a three-dimensional effect. See also **floor**.

watched cell: A cell whose value is monitored in a separate window while formulas that are associated with the cell are calculated.

web query: An external data connection that retrieves a table from a website and inserts table data into a workbook.

web-only view: A view of a workbook from within a web browser.

wide katakana: A non-cursive **character set** that is used to write non-Japanese words phonetically in Japanese. Wide katakana characters are represented with two bytes.

window state: The current positioning state of a window. Windows can be maximized or minimized, or the window size can be customized by the user.

workbook: A container for a collection of **sheets (1)**.

workbook parameter: A single cell that is designated to receive input from users.

worksheet: A single logical container for a set of tabular data and other objects in a workbook.

write reservation: A field or condition that is set on a document, workbook, or presentation to help prevent users from modifying it.

XML: The Extensible Markup Language, as described in [\[XML1.0\]](#).

XML map: A feature that is used to import data from databases and applications and to map XML elements and attributes from the associated **XML schema** to cells in a worksheet. The revised **XML** data can then be exported for interaction with other databases and applications.

XML namespace: A collection of names that is used to identify elements, types, and attributes in XML documents identified in a URI reference [RFC3986]. A combination of XML namespace and local name allows XML documents to use elements, types, and attributes that have the same names but come from different sources. For more information, see [\[XMLNS-2ED\]](#).

XML node: The smallest unit of a valid, complete structure in an XML document. For example, a node can represent an element, an attribute, or a text string.

XML Path Language (XPath): A language used to create expressions that can address parts of an XML document, manipulate strings, numbers, and Booleans, and can match a set of nodes in the document, as specified in [XPATH]. XPath models an XML document as a tree of nodes of different types, including element, attribute, and text. XPath expressions can identify the nodes in an XML document based on their type, name, and values, as well as the relationship of a node to other nodes in the document.

XML schema: A description of a type of XML document that is typically expressed in terms of constraints on the structure and content of documents of that type, in addition to the basic syntax constraints that are imposed by **XML** itself. An XML schema provides a view of a document type at a relatively high level of abstraction.

XML schema definition (XSD): The World Wide Web Consortium (W3C) standard language that is used in defining XML schemas. Schemas are useful for enforcing structure and constraining the types of data that can be used validly within other XML documents. XML schema definition refers to the fully specified and currently recommended standard for use in authoring **XML schemas**.

XOR obfuscation: A type of file encryption that helps protect private data by using an exclusive or bitwise operation. This is done by adding a mathematical expression that prevents a simple reverse-engineering process.

XPath expression: An expression that searches an XML document and can extract and manipulate data in elements or attributes within that document.

zoom level: The degree to which a portion of an image, document, or other screen object is made to appear closer or farther away relative to its default appearance. This value is usually expressed as a percentage of the default appearance.

z-order: The rendering order of an object on a z axis.

MAY, SHOULD, MUST, SHOULD NOT, MUST NOT: These terms (in all caps) are used as defined in [\[RFC2119\]](#). All statements of optional behavior use either MAY, SHOULD, or SHOULD NOT.

1.2 References

Links to a document in the Microsoft Open Specifications library point to the correct section in the most recently published version of the referenced document. However, because individual documents in the library are not updated at the same time, the section numbers in the documents may not match. You can confirm the correct section numbering by checking the [Errata](#).

1.2.1 Normative References

We conduct frequent surveys of the normative references to assure their continued availability. If you have any issue with finding a normative reference, please contact dochelp@microsoft.com. We will assist you in finding the relevant information.

[CODEPG] Microsoft Corporation, "Code Pages", <https://learn.microsoft.com/en-us/globalization/encoding/code-pages>

[DEVMODE] Microsoft Corporation, "DEVMODE structure", [http://msdn.microsoft.com/en-us/library/dd183565\(VS.85\).aspx](http://msdn.microsoft.com/en-us/library/dd183565(VS.85).aspx)

[ECMA-376] ECMA International, "Office Open XML File Formats", <https://www.ecma-international.org/publications-and-standards/standards/ecma-376/>

[IEEE754] IEEE, "IEEE Standard for Binary Floating-Point Arithmetic", IEEE 754-1985, October 1985, <http://ieeexplore.ieee.org/servlet/opac?punumber=2355>

[MS-CFB] Microsoft Corporation, "[Compound File Binary File Format](#)".

[MS-CTXLS] Microsoft Corporation, "[Excel Custom Toolbar Binary File Format](#)".

[MS-DTYP] Microsoft Corporation, "[Windows Data Types](#)".

[MS-LISTSW] Microsoft Corporation, "[Lists Web Service Protocol](#)".

[MS-OAUT] Microsoft Corporation, "[OLE Automation Protocol](#)".

[MS-ODRAW] Microsoft Corporation, "[Office Drawing Binary File Format](#)".

[MS-OFFCRYPTO] Microsoft Corporation, "[Office Document Cryptography Structure](#)".

[MS-OLEDS] Microsoft Corporation, "[Object Linking and Embedding \(OLE\) Data Structures](#)".

[MS-OSHARED] Microsoft Corporation, "[Office Common Data Types and Objects Structures](#)".

[MS-OVBA] Microsoft Corporation, "[Office VBA File Format Structure](#)".

[MS-PRSTFR] Microsoft Corporation, "[ADO XML Persistence Format](#)".

[MS-VIEWSS] Microsoft Corporation, "[Views Web Service Protocol](#)".

[MS-WSSTS] Microsoft Corporation, "[Windows SharePoint Services](#)".

[RFC1320] Rivest, R., "The MD4 Message-Digest Algorithm", RFC 1320, April 1992, <http://www.ietf.org/rfc/rfc1320.txt>

[RFC1321] Rivest, R., "The MD5 Message-Digest Algorithm", RFC 1321, April 1992, <http://www.ietf.org/rfc/rfc1321.txt>

[RFC1951] Deutsch, P., "DEFLATE Compressed Data Format Specification version 1.3", RFC 1951, May 1996, <http://www.ietf.org/rfc/rfc1951.txt>

- [RFC2119] Bradner, S., "Key words for use in RFCs to Indicate Requirement Levels", BCP 14, RFC 2119, March 1997, <https://www.rfc-editor.org/rfc/rfc2119.html>
- [RFC2781] Hoffman, P., and Yergeau, F., "UTF-16, an encoding of ISO 10646", RFC 2781, February 2000, <http://www.rfc-editor.org/rfc/rfc2781.txt>
- [RFC3986] Berners-Lee, T., Fielding, R., and Masinter, L., "Uniform Resource Identifier (URI): Generic Syntax", STD 66, RFC 3986, January 2005, <http://www.rfc-editor.org/rfc/rfc3986.txt>
- [RFC5234] Crocker, D., Ed., and Overell, P., "Augmented BNF for Syntax Specifications: ABNF", STD 68, RFC 5234, January 2008, <http://www.rfc-editor.org/rfc/rfc5234.txt>
- [SCHNEIER] Schneier, B., "Applied Cryptography, Second Edition", John Wiley and Sons, 1996, ISBN: 0471117099, <http://www.wiley.com/WileyCDA/WileyTitle/productCd-0471117099.html>
- [XMLDSig] Bartel, M., Boyer, J., Fox, B., et al., "XML-Signature Syntax and Processing", W3C Recommendation, February 2002, <http://www.w3.org/TR/2002/REC-xmlsig-core-20020212/>
- [XMLNS] Bray, T., Hollander, D., Layman, A., et al., Eds., "Namespaces in XML 1.0 (Third Edition)", W3C Recommendation, December 2009, <https://www.w3.org/TR/2009/REC-xml-names-20091208/>
- [XMLSCHEMA1/2] Thompson, H., Beech, D., Maloney, M., and Mendelsohn, N., Eds., "XML Schema Part 1: Structures Second Edition", W3C Recommendation, October 2004, <https://www.w3.org/TR/2004/REC-xmlschema-1-20041028/>
- [XMLSCHEMA2/2] Biron, P., and Malhotra, A., Eds., "XML Schema Part 2: Datatypes Second Edition", W3C Recommendation, October 2004, <https://www.w3.org/TR/2004/REC-xmlschema-2-20041028/>

1.2.2 Informative References

- [MSDN-ASRSD] Microsoft Corporation, "Absolute and Self-Relative Security Descriptors", <http://msdn.microsoft.com/en-us/library/aa374807.aspx>
- [MSDN-BMP] Microsoft Corporation, "Types of Bitmaps", <http://msdn.microsoft.com/en-us/library/ms536393.aspx>
- [MSDN-FONTS] Microsoft Corporation, "About Fonts", [http://msdn.microsoft.com/en-us/library/dd162470\(VS.85\).aspx](http://msdn.microsoft.com/en-us/library/dd162470(VS.85).aspx)
- [MSDN-MapiMessage] Microsoft Corporation, "MapiMessage (Simple MAPI)", [http://msdn.microsoft.com/en-us/library/ms529146\(EXCHG.10\).aspx](http://msdn.microsoft.com/en-us/library/ms529146(EXCHG.10).aspx)
- [MSDN-OLEDBP-OI] Microsoft Corporation, "OLE DB Programming", [http://msdn.microsoft.com/en-us/library/502e07a7\(VS.80\).aspx](http://msdn.microsoft.com/en-us/library/502e07a7(VS.80).aspx)
- [MSDN-OpenDBConnectivity] Microsoft Corporation, "Microsoft Open Database Connectivity (ODBC)", <http://msdn.microsoft.com/en-us/library/ms710252.aspx>
- [MSDN-OSTD] Microsoft Corporation, "Overview of Smart Tag Development [Office 2003 SDK Documentation]", <http://msdn.microsoft.com/en-us/library/aa169328.aspx>
- [MSDN-SOM] Microsoft Corporation, "SOM Reference", [http://msdn.microsoft.com/en-us/library/ms754618\(VS.85\).aspx](http://msdn.microsoft.com/en-us/library/ms754618(VS.85).aspx)
- [MSFT-ODBCODCO] Microsoft Corporation, "ODBC--Open Database Connectivity Overview", March 2007, <http://support.microsoft.com/kb/110093>
- [MSFT-XL2000] Microsoft Corporation, "XL2000: Unable to Share Custom Lists", Article ID 212245, November 2003, <http://support.microsoft.com/kb/212245/>

1.3 Overview

This document specifies **workbook** data contained in a compound file as described in [\[MS-CFB\]](#). The data is stored in the compound file by using storages, **streams** (section [2.1.2](#)), and **substreams** (section [2.1.3](#)) that contain information about the content and structure of a workbook, including workbook data such as **worksheet** definitions. Some storages, **streams**, and **substreams** store information by using binary **records** (section [2.1.4](#)). The binary **record** (section [2.1.4](#)) structure and content are specified in this document. Each binary **record** contains its record type, information about the record size, and zero or more type-specific fields depending on the record type, which is specified in section [2.3](#). Type-specific fields contain information further specifying the workbook data. Specifications of the fields for a given record type can be found in section [2.4](#).

See the **File Structure** section (section [2.1](#)) for a more detailed overview of specific file architecture and content.

1.3.1 stream Byte Ordering

Some computer architectures number bytes in a binary word from left to right, which is referred to as **big-endian**. This documentation uses big-endian bit diagrams. Other architectures number the bytes in a binary word from right to left, which is referred to as **little-endian**. The underlying file format enumerations, objects, and records are little-endian.

Using big-endian and little-endian methods, the number 0x12345678 would be stored as shown in the following table:

Byte order	Byte 0	Byte 1	Byte 2	Byte 3
Big-endian	0x12	0x34	0x56	0x78
Little-endian	0x78	0x56	0x34	0x12

Unless otherwise specified, all data in files of the type specified by this document are stored in little-endian format.

1.3.2 Organization of This Documentation

Section [2](#) of this document is arranged with overviews of higher-level concepts being followed by more detailed concepts. Section [2.1](#) and section [2.2](#), in particular, specify higher-level concepts that are required to understand the remainder of the document, and are read before reading the remainder of section [2](#).

Section [2.1](#) specifies the structures and concepts that are used to organize and structure the file itself. Subsection [2.1.7](#) further specifies the valid storages, **streams** (section [2.1.2](#)), and **substreams** (section [2.1.3](#)) allowed within files of the type specified by this document.

Section [2.2](#) specifies higher-level concepts that are normatively described for use in later sections of this document.

Section [2.3](#) specifies the record name associated with a given record type. For more information about record types, see section [2.1.4](#). These associations are listed by record name as well as by record type.

Section [2.4](#) specifies the details of individual records.

Section [2.5](#) specifies the details of structures used by records and other structures.

Section 3 provides specific examples intended to illustrate the concepts, records, and structures of this file format.

Section 4 discusses encryption, obfuscation and other security issues relating to files of the type specified by this document.

Section 5 is a list of version-specific behaviors. It is not intended to be read alone, but rather to be understood in the context of specifications in section 2. Specifications in section 2 provide links to the relevant items in Section 5.

1.4 Relationship to Protocols and Other Structures

The Excel Binary File Format is an **OLE compound file** as described in [\[MS-CFB\]](#). It is dependent on the structures defined in the following references:

- [\[ECMA-376\]](#) for the persistence of custom **XML** mappings.
- [\[MS-CTXLS\]](#) for command bar tables.
- [\[MS-ODRAW\]](#) for the persistence format for **shapes**.
- [\[MS-OFFCRYPTO\]](#) for the persistence format for document signing, information rights management, document encryption and obfuscation.
- [\[MS-OVBA\]](#) for the persistence format for a **VBA project**.
- [\[MS-OSHARED\]](#) for the persistence format for additional common structures.

1.5 Applicability Statement

This document specifies a persistence format for **workbook** content and templates, which can include unstructured or semi-structured tables of numbers, text, or both numbers and text, formulas, external data connections, charts and images. This persistence format is applicable for persistence of documents with a grid-based layout, including those with numeric data, structured data, and formulas.

This persistence format is applicable for use as a stand-alone document, and for containment within other documents as an embedded object as described in [\[MS-OLEDS\]](#).

This persistence format provides interoperability with applications that create or read documents conforming to this structure.

1.6 Versioning and Localization

This document covers versioning issues in the following areas:

Structure Versions: There is only one version of the Excel Binary File Format (.xls) Structure Specification.

Localization: The following records and structures contain fields that specify locale-dependent meaning:

- **Header** (section [2.4.136](#))
- **Footer** (section [2.4.124](#))
- **Format** (section [2.4.126](#))
- **CodeName** (section [2.4.51](#))
- **Font** (section [2.4.122](#))

The Security Considerations section (section [4](#)), the **Password Verifier Algorithm** section (section [2.2.9](#)), the Encryption (Password to Open) section (section [2.2.10](#)), and the **Macro Sheet Substream** section (section [2.1.7.20.4](#)) also specify processes and data that are locale-dependent. See each record, structure, and section description for more information.

1.7 Vendor-Extensible Fields

This persistence format can be extended by storing information in **streams** and storages not specified in section [2](#). Implementations are not required to preserve or remove additional streams or storages when modifying an existing document.

2 Structures

2.1 File Structure

This section specifies the overall structure of a file that conforms to this specification.

A file of the type specified by this document is an **OLE compound file**. A **compound file** (section [2.1.1](#)) contains storages, **streams** (section [2.1.2](#)), and **substreams** (section [2.1.3](#)). Each **stream** or **substream** contains a series of binary **records** (section [2.1.4](#)). Each binary **record** contains zero or more structured fields that contain the **workbook** data.

2.1.1 Compound File

A file of the type specified by this document MUST be an **OLE compound file** as specified in [\[MS-CFB\]](#).

2.1.2 Stream

A file of the type specified by this document consists of storages and **streams** as specified in [\[MS-CFB\]](#). Each binary stream or **substream** (section [2.1.3](#)) that contains **workbook** data MUST be written as a series of binary **records** (section [2.1.4](#)) as specified in section [2.1.7](#).

The valid storages, streams, and **substreams** in a file of the type specified by this document are specified in section [2.1.7](#).

A workbook MUST contain the **workbook** stream (section [2.1.7.20](#)), with at least one **sheet (1) substream** (**Worksheet Substream** (section [2.1.7.20.5](#)), **Chart Sheet Substream** (section [2.1.7.20.1](#)), **Macro Sheet Substream** (section [2.1.7.20.4](#)), or **Dialog Sheet Substream** (section [2.1.7.20.2](#))) that follows the **Globals Substream** (section [2.1.7.20.3](#)).

This document uses **Augmented Backus-Naur Form (ABNF)** as specified in [\[RFC5234\]](#) to specify the **record** sequence for **streams** and **substreams** that contain binary **records**.

2.1.3 Substream

The **workbook** stream (section [2.1.7.20](#)) contains substreams that specify global properties and data for a **workbook** and specify the **sheets (1)** that constitute the workbook. The beginning of each substream is marked by a **BOF** record (section [2.4.21](#)) that has a **dt** field that specifies the type of the substream. The end of each substream is marked by an **EOF record** (section [2.4.103](#)).

For more information about these substreams, see section [2.1.7.20](#) and subsections.

2.1.4 Record

A record is the basic building block used to store information about features in a **workbook**. Each binary record is a variable-length sequence of bytes. A binary record consists of three components: a record type, a record size, and the record data that is specific to that record type.

The record type is a two-byte unsigned integer that specifies what type of information is specified by the record and how the structure of the record data specific to this record is ordered and structured. Record type values MUST be a value from the **Record** Enumeration (section [2.3](#)) or the record MUST make use of the **future record** architecture (section [2.1.6](#)).

The record size is a two-byte unsigned integer that specifies the count of bytes that specifies the total size of the record data. The record size MUST be greater than or equal to 0 and MUST be less than or equal to 8224.

The record data component contains fields that correspond to a particular record type and comprise the remainder of the record. The order and structure of the fields for a given record type listed in section 2.3 are specified in the corresponding section for that record type in section 2.4. The size of the record data component MUST be equal to the record size. Fields in the record data component can contain simple values, arrays of values, structures of several fields, arrays of fields, and arrays of structures.

If the total number of bytes to be written for a given record data component is greater than 8224, a collection of **Continue** (section 2.4.58), **ContinueFrt** (section 2.4.60), **ContinueFrt11** (section 2.4.61), or **ContinueFrt12** (section 2.4.62) records, as specified in the respective **ABNF** for that record, is used to contain the remaining record data. In general, the first 8224 bytes of data is contained in the record data component of the given record and the remaining data is divided into blocks of 8224 bytes and contained in the subsequent collection of **Continue** (section 2.4.58), **ContinueFrt** (section 2.4.60), **ContinueFrt11** (section 2.4.61), or **ContinueFrt12** records, until all the data is written. See specific record definitions for exceptions. **ContinueBigName** (section 2.4.59) and **CrtMIFrtContinue** (section 2.4.71) are special cases that only apply to a single record type.

2.1.5 Collection of Records

A collection of **records** (section 2.1.4) is a series of related **records** that are treated as a single set. **Records** in a collection do not have to share the same **record** type. A collection of **records** can further contain other collections of **records**. The beginning of a collection of **records** is sometimes indicated by a different type of **record**, as specified in the **record** sequence **ABNF** where the rule that contains that **record** is specified. Similarly the end of a collection of **records** is sometimes indicated by a different type of **record**, as specified by the **record** sequence **ABNF** where the rule that contains that **record** is specified. Each **record** or collection within the collection can be referred to by index, and the index count starts over for each collection.

In this document, **record** A precedes **record** B when **record** A is the last **record** of that type to appear before **record** B, in the **stream** (section 2.1.2) or **substream** (section 2.1.3) that contains those **records**.

In this document, **record** B follows **record** A when **record** A is the last **record** of that type to appear before **record** B, in the **stream** or **substream** that contains those **records**.

2.1.6 Future Record

The future record architecture enables an application that does not support certain **records** (section 2.1.4) to open and save the file while ignoring but preserving those **records** in the file. **Records** that contain an **FRTHeader** (section 2.5.135), **FrtHeaderOld** (section 2.5.136), **FrtRefHeader** (section 2.5.137), **FrtRefHeaderNoGrbit** (section 2.5.138), or **FrtRefHeaderU** (section 2.5.139) structure, as specified in this document, are future records and can be treated as such by an application that implements the future record architecture. Future **records** that are not supported by an application can be cached on load and persisted on save, enabling the data to be retained in the file for an application that does support those **records**. When loading and caching these unsupported **records**, an application can process **range** references associated with the unsupported **records** as specified in the **FRTHeader**, **FrtHeaderOld**, **FrtRefHeader**, **FrtRefHeaderNoGrbit**, or **FrtRefHeaderU** structures. The application can adjust these range references as **cells** are inserted, deleted or moved in the **sheets** (1) to preserve the correctness and validity of these range references associated with the unsupported **records** when saving the **workbook** along with the unsupported **records**.

For an in-depth discussion of how these structures relate to each other, read the specification for each structure in section 2.5.

2.1.6.1 Chart

There are three types of **future records** (section [2.1.6](#)) that can appear in the **Chart Sheet Substream** (section [2.1.7.20.1](#)).

The first type of **future record** is specific to a **chart** (section [2.2.3.3](#)) and is stored by using the **future record** architecture as specified in the Future Record section (section 2.1.6). Specifically, these **future records** that are specific to **charts** have a record type that MUST be greater than or equal to 2048 and MUST be less than or equal to 2303, as specified in section [2.3](#). These **future records** MUST exist in the collection of **records** (section [2.1.4](#)) specified by the **StartBlock** records (section [2.4.266](#)) and **EndBlock** records (section [2.4.100](#)), unless they exist in the collection of **records** specified by the **StartObject** records (section [2.4.267](#)) and **EndObject** records (section [2.4.101](#)). The **StartBlock** records (section 2.4.266) and **EndBlock** records themselves MUST NOT appear in the collection of **records** specified by the **StartObject** records and **EndObject** records. Furthermore, a **ChartFrtInfo** record (section [2.4.49](#)) MUST precede the first **future record** that is specific to a **chart** in a **Chart Sheet Substream**.

The second type of **future record** is stored by wrapping otherwise non-**future records** in the **FrtWrapper** record (section [2.4.130](#)), as specified in section 2.4.130. These **records** MUST be written in their entirety (the record type, record size and record data components, as specified in section 2.1.4) in the **wrappedRecord** field of the **FrtWrapper** record. These MUST exist in the collection of **records** specified by the **StartObject** records and **EndObject** records.

The third type of **future record** is any other **future record** that is stored by using the **future record** architecture as specified in section 2.1.6, not belonging to the first two types.

See the respective **record definitions** (section [2.4](#)) for details on how these **records** are written relative to other **future records** in the **Chart Sheet Substream**.

2.1.6.2 PivotTable

PivotTables (section [2.2.5](#)) implement the future record architecture as specified in section [2.1.6](#). There are multiple classes of PivotTable records (section [2.2.5.1](#)) represented using the **SXAddl record** (section [2.4.273.2](#)). Each **record** (section [2.1.4](#)) in a class specifies a different piece of information for the part of the **PivotTable** (section 2.2.5) to which the **SXAddl record** applies. For more information about how the **SXAddl record** is used, read section [2.2.5.1.1](#).

2.1.7 Storages and Streams

This section specifies the **storages**, **streams** and substreams of the Excel Binary File Format (.xls) file. Refer to section [2.1](#) for an understanding of storages, **streams**, and **substreams**.

If the stream is in **Binary Interchange File Format (BIFF)** format, the record sequence is specified using **ABNF** grammar.

2.1.7.1 Component Object Stream (\001CompObj)

The Component Object Stream is specified in [\[MS-OLEDS\]](#) section [2.3.8](#).

The name of this **stream** MUST be "\001CompObj", where \001 is the character with the value 0x01, not the string literal "\001".

A file MUST contain at most one **Component Object Stream**.

2.1.7.2 Control Stream (Ctls)

An instance of the **Control Stream** specifies the **OLE objects** and **ActiveX controls** that use stream-based persistence.

The name of this **stream** MUST be "Ctls". A file MUST contain at most one **Control Stream**. An object persisted in this stream MUST have a corresponding **Obj** record (section [2.4.181](#)) in a **worksheet substream** (section [2.1.7.20.5](#)) with a **cmo.ot** field that equals 8 and a **pictFlags.fPrstm** field that equals 1. The **pictFmla.lPosInCtlStm** and **pictFmla.cbBufInCtlStm** fields of the **Obj** record specify the location of the object data associated with that **Obj** record.

2.1.7.3 Data Spaces Storage (\006DataSpaces)

The Data Spaces Storage is specified in [\[MS-OFFCRYPTO\]](#) section 2.1.

The name of this **storage** MUST be "\006DataSpaces", where \006 is the character with the value 0x06, not the string literal "\006". A file MUST contain at most one **Data Spaces Storage**.

2.1.7.4 Document Summary Information Stream (\005DocumentSummaryInformation)

The Document Summary Information Stream is specified in [\[MS-OSHARED\]](#) section 2.3.3.2.2.

The name of this **stream** MUST be "\005DocumentSummaryInformation", where \005 is the character with the value 0x05, not the string literal "\005". A file MUST contain at most one Document Summary **Information Stream**.

2.1.7.5 Embedding Storage (MBD...)

An instance of the **Embedding Storage** specifies an embedded **OLE object** or an **ActiveX control** that uses **storage**-based persistence.

The name of this storage MUST be "MBD" followed by eight hexadecimal digits uniquely identifying the **embedded object**. An object persisted in an **Embedding Storage** MUST have a corresponding **Obj** (section [2.4.181](#)) in a **worksheet substream** (section [2.1.7.20.5](#)), **macro sheet substream** (section [2.1.7.20.4](#)), or **dialog sheet substream** (section [2.1.7.20.2](#)) with a **cmo.ot** field that equals 8, a **pictFlags.fPrstm** field that equals 0, and a **pictFlags.fDde** field that equals 0. The **pictFmla.lPosInCtlStm** field of the **Obj** record specifies the name of the **Embedding Storage** that is associated with that **Obj** record.

2.1.7.6 Encryption Stream (encryption)

The Encryption Stream is specified in [\[MS-OFFCRYPTO\]](#) section 2.3.5.4.

The name of this **stream** MUST be "encryption". A file MUST contain at most one **Encryption Stream**.

2.1.7.7 Link Storage (LNK...)

An instance of the **Link Storage** specifies a linked **OLE object** and any default data or presentation caching established for it.

The name of this storage MUST be "LNK" followed by eight hexadecimal digits uniquely identifying the **linked object**. An object persisted in a **Link Storage** MUST have a corresponding **Obj** (section [2.4.181](#)) in a **worksheet substream** (section [2.1.7.20.5](#)), **macro sheet substream** (section [2.1.7.20.4](#)), or **dialog sheet substream** (section [2.1.7.20.2](#)) with a **cmo.ot** field that equals 8, a **pictFlags.fPrstm** field that equals 0, and a **pictFlags.fDde** field that equals 1. Additionally, the **pictFmla.fmla** field of the **Obj** record (section [2.4.181](#)) specifies a formula that refers to an

ExternName (section [2.4.105](#)) with a **body** field of type **ExternOleDdeLink** (section [2.5.107](#)) with a **IStgName** field that specifies the name of the **Link Storage** that is associated with that **Obj** record.

2.1.7.8 List Data Stream (List Data)

The List **Data Stream** specifies one or more Web-based **data provider data source** definitions. Each data source definition is related to a Web-based data provider list.

The name of the **stream** MUST be "List Data". A file MUST contain at most one List **Data Stream**. Each data source definition is related to a **Feature11** record (section [2.4.114](#)) or **Feature12** record (section [2.4.115](#)). The **IPosStmCache**, **cbStmCache** and **cchStmCache** fields of the **TableFeatureType** structure (section [2.5.266](#)) specify the relationship between the **Feature11** record or **Feature12** record and the **List Data Stream**.

Each data source definition is specified as a compressed stream. The compression algorithm is specified in [\[RFC1951\]](#). The stream is specified by the following **XML schema**:

```
<?xml version="1.0" encoding="utf-8"?>
<s:schema xmlns:rs="urn:schemas-microsoft-com:rowset"
  xmlns:z="#RowsetSchema"
  attributeFormDefault="unqualified"
  elementFormDefault="qualified"
  xmlns:s="http://www.w3.org/2001/XMLSchema">
  <s:element name="LIST">
    <s:complexType>
      <s:attribute name="Version" type="s:string" use="required" />
      <s:sequence>
        <s:element name="LISTNAME" type="s:string" />
        <s:element name="VIEWGUID" type="s:string" minOccurs="0"/>
        <s:element name="LISTWEB" type="s:string" />
        <s:element name="ROOTFOLDER" type="s:string" />
        <s:element name="LISTSCHEMA">
          <s:complexType mixed="true" >
            <s:sequence>
              <s:any />
            </s:sequence>
          </s:complexType>
        </s:element>
        <s:element name="VIEWSCHEMA" minOccurs="0">
          <s:complexType mixed="true" >
            <s:sequence>
              <s:any />
            </s:sequence>
          </s:complexType>
        </s:element>
        <s:element name="LISTDATA" minOccurs="0">
          <s:complexType>
            <s:sequence>
              <s:element ref="rs:data" />
            </s:sequence>
          </s:complexType>
        </s:element>
        <s:element name="UPDATE">
          <s:complexType>
            <s:sequence>
              <s:element name="Inserts" minOccurs="0">
                <s:complexType>
                  <s:sequence>
                    <s:element ref="rs:data" />
                  </s:sequence>
                </s:complexType>
              </s:element>
              <s:element name="Updates" minOccurs="0">
                <s:complexType>
                  <s:sequence>
                    <s:element ref="rs:data" />
                  </s:sequence>
                </s:complexType>
              </s:element>
            </s:sequence>
          </s:complexType>
        </s:element>
      </s:sequence>
    </s:complexType>
  </s:element>
</s:schema>
```

```

        </s:sequence>
      </s:complexType>
    </s:element>
    <s:element name="Deletes" minOccurs="0">
      <s:complexType>
        <s:sequence>
          <s:element ref="rs:data" />
        </s:sequence>
      </s:complexType>
    </s:element>
  </s:sequence>
</s:complexType>
</s:element>
<s:element name="LISTDATAFTR" type="s:string" />
</s:sequence>
</s:complexType>
</s:element>
</s:schema>

```

2.1.7.8.1 Attributes

The following table specifies the attributes that can be used in the LIST element:

Attribute	Description
Version	Web-based data provider server version from which the data was retrieved. MUST be less than or equal to 20 characters.

2.1.7.8.2 Elements

The following table specifies the **XML schema definition (XSD)** elements that are specific to the LIST element:

Element	Description
LISTNAME (section 2.1.7.8.2.1)	Display name or GUID , as specified by [MS-DTYP] , of a Web-based data provider list.
VIEWGUID (section 2.1.7.8.2.2)	GUID, as specified by [MS-DTYP] , of a Web-based data provider list view .
LISTWEB (section 2.1.7.8.2.3)	Uniform Resource Identifier (URI) of the Web-based data provider server from which the list was retrieved.
ROOTFOLDER (section 2.1.7.8.2.4)	Path on the Web-based data provider server where the list is located.
LISTSCHEMA (section 2.1.7.8.2.5)	XML schema of the fields of the Web-based data provider list.
VIEWSCHEMA (section 2.1.7.8.2.6)	XML schema of the Web-based data provider list view.
LISTDATA (section 2.1.7.8.2.7)	Specifies the data of the list.
UPDATE (section 2.1.7.8.2.8)	Specifies the inserted, deleted, and updated fields that were modified from the original data source .

Element	Description
LISTDATAFTR (section 2.1.7.8.2.9)	Validation footer used to validate the integrity of the data within the stream .

2.1.7.8.2.1 LISTNAME

The **LISTNAME** element specifies a list on the Web-based **data provider** server. It MUST be the display name or the **GUID**, as specified by [\[MS-DTYP\]](#), of a **list**. The **LISTNAME** element is specified as follows:

```
<s:element name="LISTNAME" type="s:string" />
```

2.1.7.8.2.2 VIEWGUID

The **VIEWGUID** element specifies a list view on the server. It MUST be the **GUID**, as specified by [\[MS-DTYP\]](#), of a list view. The **VIEWGUID** element is specified as follows:

```
<s:element name="VIEWGUID" type="s:string" minOccurs="0"/>
```

When the **VIEWGUID** element is not present or the value of the **VIEWGUID** element is empty, the current **data source** definition within the **List Data Stream** (section [2.1.7.8](#)) MUST retrieve data from the default list view of the list on the server.

2.1.7.8.2.3 LISTWEB

The **LISTWEB** element specifies, as a **URI**, the name of the Web-based **data provider** server from which the list data was retrieved. MUST be a valid URI, as specified by [\[RFC3986\]](#). The **LISTWEB** element is specified as follows:

```
<s:element name="LISTWEB" type="s:string"/>
```

2.1.7.8.2.4 ROOTFOLDER

The **ROOTFOLDER** element specifies the path from the **LISTWEB URI** where the Web-based **data provider** list from which the data was retrieved is located. When concatenated to the end of the **LISTWEB** field value, the result MUST be a valid URI, as specified by [\[RFC3986\]](#). The **ROOTFOLDER** element is specified as follows:

```
<s:element name="ROOTFOLDER" type="s:string"/>
```

2.1.7.8.2.5 LISTSCHEMA

The **LISTSCHEMA** element specifies the fields of the Web-based **data provider** list from which the data was retrieved, along with additional information. The additional information includes **regional settings** and whether attachments are enabled. The **LISTSCHEMA** element is specified as follows:

```
<s:element name="LISTSCHEMA" minOccurs="0">
  <s:complexType mixed="true" >
    <s:sequence>
      <s:any />
    </s:sequence>
```

```
</s:complexType>
</s:element>
```

The **LISTSCHEMA** element is further specified in [\[MS-LISTSWS\]](#) section 2.2.4.12.

2.1.7.8.2.6 VIEWSCHEMA

The **VIEWSCHEMA** element specifies the list view of the Web-based **data provider** list from which the data was retrieved. The **VIEWSCHEMA** element is specified as follows:

```
<s:element name="VIEWSCHEMA" minOccurs="0">
  <s:complexType mixed="true" >
    <s:sequence>
      <s:any />
    </s:sequence>
  </s:complexType>
</s:element>
```

The **VIEWSCHEMA** element is further specified in [\[MS-VIEWSS\]](#) section 2.2.

2.1.7.8.2.7 LISTDATA

The **LISTDATA** element specifies the data retrieved from the Web-based **data provider** list. The **LISTDATA** element is specified as follows:

```
<s:element name="LISTDATA">
  <s:complexType>
    <s:sequence>
      <s:element ref="rs:data" />
    </s:sequence>
  </s:complexType>
</s:element>
```

The referenced **rs:data** type is specified in [\[MS-PRSTFR\]](#) section 2.2. Additional information and examples is also specified in [\[MS-LISTSWS\]](#) section 3.1.4.21.2.2.

2.1.7.8.2.8 UPDATE

The **UPDATE** element specifies the inserted, deleted, and updated fields that were modified from the data specified in **LISTDATA** (section [2.1.7.8.2.7](#)). The definition of the **UPDATE** element is as follows:

```
<s:element name="UPDATE">
  <s:complexType>
    <s:sequence>
      <s:element name="Inserts" minOccurs="0">
        <s:complexType>
          <s:sequence>
            <s:element ref="rs:data" />
          </s:sequence>
        </s:complexType>
      </s:element>
      <s:element name="Updates" minOccurs="0">
        <s:complexType>
          <s:sequence>
            <s:element ref="rs:data" />
          </s:sequence>
        </s:complexType>
      </s:element>
    </s:sequence>
  </s:complexType>
</s:element>
```

```

<s:element name="Deletes" minOccurs="0">
  <s:complexType>
    <s:sequence>
      <s:element ref="rs:data" />
    </s:sequence>
  </s:complexType>
</s:element>
</s:sequence>
</s:complexType>
</s:element>

```

The **UPDATE** element is a parent element, which contains 3 optional child elements: **Inserts**, **Updates** and **Deletes**. **Inserts** specifies rows that were added locally, and are not synchronized with the **data source**. **Updates** specifies rows that were modified locally, and that are not synchronized with the data source. **Deletes** specifies rows that were deleted locally, and that are not synchronized with the data source. The referenced **rs:data** type for each of the elements is specified in [\[MS-PRSTFR\]](#) section 2.2. Additional information and examples is also specified in [\[MS-LISTSWS\]](#) section 3.1.4.21.2.2.

2.1.7.8.2.9 LISTDATAFTR

The **LISTDATAFTR** element specifies elements used to validate the integrity of the data within the **stream**. It contains a sequence of signed integers which specify the **MD5 hash** of each **rs:data** within the stream. The definition of the **LISTDATAFTR** element is as follows:

```

<s:element name="LISTDATAFTR" type="s:string" />

```

The signed integers specified in the string data MUST be separated by the ";" separator. There MUST be an MD5 hash, as specified by [\[RFC1321\]](#), for the **LISTDATA** element, the **UPDATE.Inserts** element, the **UPDATE.Updates** element and the **UPDATE.Deletes** element. The MD5 hash MUST appear in the following order: **LISTDATA** element, the **UPDATE.Inserts** element, the **UPDATE.Updates** element and the **UPDATE.Deletes** element. If an element is not present in the stream, the corresponding MD5 hash MUST NOT be present.

2.1.7.9 Office Data Store Storage (MsoDataStore)

The **Office Data Store Storage** is specified in [\[MS-OSHARED\]](#) section 2.3.6.

The name of this storage MUST be "MsoDataStore". A file MUST contain at most one **Office Data Store Storage**.

2.1.7.10 Office Toolbars Stream (XCB)

The **Office Toolbars Stream** specifies the custom toolbars attached to the file.

The name of this **stream** MUST be "XCB". A file MUST contain at most one **Office Toolbars Stream**. This stream MUST only contain a single **CTBWRAPPER** structure (section [2.6.1](#)).

Parts of this stream are specified in [\[MS-OSHARED\]](#) section 2.3.1. Refer to [\[MS-OSHARED\]](#) section 1.3 for a diagram that illustrates an example of the XCB binary stream with its toolbar customization structures.

Following is the record sequence **ABNF** for the XCB binary stream:

```

XCB = CTBWRAPPER
CTBWRAPPER = CTBS 1*CTB

```

For more information about the **CTBWRAPPER** structure, see section 2.6.1. For more information about the **CTBS** structure, see section [2.6.2](#). For more information about the **CTB** structure, see section [2.6.3](#).

2.1.7.11 OLE Stream (\001Ole)

The OLE Stream is specified in [\[MS-OLEDS\]](#) section [2.3.3](#).

The name of this **stream** MUST be "\001Ole", where \001 is the character with the value 0x01, not the string literal "\001".

A file MUST contain at most one **OLE Stream**.

2.1.7.12 Pivot Cache Storage (_SX_DB_CUR)

The **Pivot Cache Storage** specifies zero or more streams, each of which specify a **PivotCache** (section [2.2.5.3](#)) for a **PivotTable** (section [2.2.5](#)). The name of each **stream** MUST be unique within the storage, and the name MUST be a four digit hexadecimal number stored as text.

The name of this storage MUST be "_SX_DB_CUR". A file MUST contain at most one **Pivot Cache Storage**.

The number of **FDB** rules that occur MUST be equal to the value of **cfdbTot** in the **SXDB record** (section [2.4.275](#)).

Record sequence **ABNF** for each stream:

```
PIVOTCACHE = SXDB SXDBEx *SXFORMULA *FDB *DBB EOF

FDB = SXFDB SXFDBType [SXFMLA / (*GRPSXOPER [SXRRANGE / *(SxIsxoper *Continue)]]] *SRCSXOPER

DBB = [SXDBB] *SXOPER

SXFORMULA = SXFMLA PIVOTRULE SXFormula

SXFMLA = SxFmla *(SxName *SXPair)

GRPSXOPER = SXOPER

SRCSXOPER = SXOPER

SXOPER = SxNil / SXNum / SxBool / SxErr / SXString / SXDtr

SXRRANGE = SXRng (3SXNum / (2SXDtr SXInt))
```

2.1.7.13 Protected Content Stream (\009DRMContent)

The **Protected Content Stream** is specified in [\[MS-OFFCRYPTO\]](#) section 2.2.10.

The name of this **stream** MUST be "\009DRMContent", where \009 is the character with the value 0x09, not the string literal "\009". A file MUST contain at most one **Protected Content Stream**.

2.1.7.14 Revision Stream (Revision Log)

An instance of the **Revision Stream** specifies the **revision logs** (section [2.2.11.2](#)) and **revision records** (section [2.2.11.3](#)) for a **shared workbook** (section [2.2.11](#)).

The name of this **stream** MUST be "Revision Log". A file MUST contain at most one **Revision Stream**. The **Revision Stream** MUST exist if the **workbook** is a **shared workbook** (section 2.2.11).

Record sequence **ABNF**:

```
REVISION = RRDInfo FileLock UsrExcl *(HEADER *(RENSHEET / INSDEL / CONFLICT / INSDELISH / CHGCELL / MOVE / FORMAT / AUTOFMT / DEFNAME / VIEW / NOTE / TRASHQTFIELD)) EOF

HEADER = RRDHead RRTabId

RENSHEET = RRDRenSheet

INSDEL = INS / DEL

INS = RRDInsDel *(CHGCELL / FORMAT)

DEL = RRDInsDelBegin RRDInsDel *(CHGCELL / FORMAT) RRDInsDelEnd

CONFLICT = RRDConflict

INSDELISH = RRInsertSh

CHGCELL = RRDChgCell *Continue *RRDRstEtxp

MOVE = RRDMoveBegin RRDMove *(CHGCELL / FORMAT) RRDMoveEnd

FORMAT = RRFormat

AUTOFMT = RRAutoFmt

DEFNAME = RRDDefName

VIEW = RRDUserView

NOTE = Note

TRASHQTFIELD = RRDTQSIF
```

2.1.7.15 Signatures Stream (_signatures)

The **Signatures Stream** is specified in [\[MS-OFFCRYPTO\]](#) section 2.5.1.

The name of this **stream** MUST be "_signatures". A file MUST contain at most one **Signatures Stream**[<1>](#).

When generating the **Signature** value, as specified in [\[MS-OFFCRYPTO\]](#) section 2.5.1.5, the record data, as specified in section [2.1.4](#), of the **WriteAccess record** (section [2.4.349](#)) in the **Globals Substream** (section [2.1.7.20.3](#)) is skipped.

2.1.7.16 Summary Information Stream (\005SummaryInformation)

The **Summary Information Stream** is specified in [\[MS-OSHARED\]](#) section 2.3.3.2.1.

The name of this **stream** MUST be "\005SummaryInformation", where \005 is the character with the value 0x05, not the string literal "\005". A file MUST contain at most one **Summary Information Stream**.

2.1.7.17 User Names Stream (User Names)

The **User Names Stream** specifies a **user log** (section [2.2.11.1](#)) for a **shared workbook** (section [2.2.11](#)).

The name of this **stream** MUST be "User Names". The presence of the **User Names Stream** indicates the **workbook** is a **shared workbook** (section 2.2.11). A file MUST contain at most one **User Names Stream**.

Record sequence **ABNF**:

```
USERNAMES = CUsr UsrChk CbUsr BCUsrs *UsrInfo
```

2.1.7.18 VBA Storage (_VBA_PROJECT_CUR)

The **VBA Storage** is specified in [\[MS-OVBA\]](#).

The name of this storage MUST be "_VBA_PROJECT_CUR". A file MUST contain at most one **VBA Storage**.

2.1.7.19 Viewer Content Stream (\009DRMViewerContent)

The **Viewer Content Stream** is specified in [\[MS-OFFCRYPTO\]](#) section 2.2.11.

The name of this **stream** MUST be "\009DRMViewerContent", where \009 is the character with the value 0x09, not the string literal "\009". A file MUST contain at most one **Viewer Content Stream**.

2.1.7.20 Workbook Stream (Workbook)

The **Workbook Stream** specifies global properties and data for a **workbook**, as well as the **sheets (1)** that constitute a workbook.

The name of this **stream** MUST be "Workbook". A file MUST contain exactly one **Workbook Stream**, which consists of several substreams. There MUST be exactly one **substream** (section [2.1.7.20.3](#)), and the **substream** MUST be the first substream to appear in the **Workbook Stream**, which MUST be followed by one or more of the following substreams:

- **Chart Sheet Substream** (section [2.1.7.20.1](#))
- **Dialog Sheet Substream** (section [2.1.7.20.2](#))
- **Macro Sheet Substream** (section [2.1.7.20.4](#))
- **Worksheet Substream** (section [2.1.7.20.5](#))

2.1.7.20.1 Chart Sheet Substream

The **Chart Sheet Substream** specifies either a separate **chart sheet** that contains a single chart, or an **embedded chart object** (section [2.2.3.1](#)) contained within a **worksheet** (section [2.1.7.20.5](#)) or **macro sheet** (section [2.1.7.20.4](#)).

If a record in the **ABNF** grammar for this substream is one of the following: **Font** (section [2.4.122](#)), **Continue** (section [2.4.58](#)), **LineFormat** (section [2.4.156](#)), **AreaFormat** (section [2.4.3](#)), **SeriesText** (section [2.4.254](#)), **DefaultText** (section [2.4.88](#)), **Text** (section [2.4.324](#)), **FontX** (section [2.4.123](#)), **ObjectLink** (section [2.4.182](#)), **Frame** (section [2.4.128](#)), **Begin** (section [2.4.17](#)), **End** (section [2.4.99](#)), **PicF** (section [2.4.193](#)), **Pos** (section [2.4.201](#)), **AIRuns** (section [2.4.1](#)), **BRAI** (section [2.4.29](#)), **Fbi** (section [2.4.109](#)), or **GelFrame** (section [2.4.131](#)), and is in a collection specified by

StartObject (section [2.4.267](#)) and **EndObject** (section [2.4.101](#)), that record MUST be replaced by an **FrWrapper** record (section [2.4.130](#)) and the **wrappedRecord** field of that **FrWrapper** record MUST specify the record that is replaced. **StartBlock** record (section [2.4.266](#)) and **EndBlock** record (section [2.4.100](#)) pairs and **ChartFrInfo** (section [2.4.49](#)) are omitted from the ABNF grammar. See section [2.1.6.1](#) and the respective record specifications for more information.

Record sequence<2> ABNF:

```

CHARTSHEETCONTENT = [WriteProtect] [SheetExt] [WebPub] *HFPicture PAGESETUP PrintSize
[HeaderFooter] [BACKGROUND] *Fbi *Fbi2 [ClrClient] [PROTECTION] [Palette] [SXViewLink]
[PivotChartBits] [SBaseRef] [MsoDrawingGroup] OBJECTS Units CHARTFOMATS SERIESDATA
*WINDOW *CUSTOMVIEW [CodeName] [CRTMLFRT] EOF

CHARTSHEET = BOF CHARTSHEETCONTENT

CHARTFOMATS = Chart Begin *2FONTLIST Scl PlotGrowth [FRAME] *SERIESFORMAT *SS ShtProps *2DFTTEXT
AxesUsed 1*2AXISPARENT [CrtLayout12A] [DAT] *ATTACHEDLABEL [CRTMLFRT] *([DataLabExt
StartObject] ATTACHEDLABEL [EndObject]) [TEXTPROPS] *2CRTMLFRT End

FONTLIST = FrtFontList StartObject *(Font [Fbi]) EndObject

AXISPARENT = AxisParent Begin Pos [AXES] 1*4CRT End

SERIESDATA = Dimensions 3(SIIndex *(Number / BoolErr / Blank / Label))

AXES = [IVAXIS DVAXIS [SERIESAXIS] / DVAXIS DVAXIS] *3ATTACHEDLABEL [PlotArea FRAME]

IVAXIS = Axis Begin [CatSerRange] AxcExt [CatLab] AXS [CRTMLFRT] End

DVAXIS = Axis Begin [ValueRange] [AXM] AXS [CRTMLFRT] End

SERIESAXIS = Axis Begin [CatSerRange] AXS [CRTMLFRT] End

CRT = ChartFormat Begin (Bar / Line / (BopPop [BopPopCustom]) / Pie / Area / Scatter / Radar /
RadarArea / Surf) CrtLink [SeriesList] [Chart3d] [LD] [2DROPBAR] *4(CrtLine LineFormat
*2DFTTEXT [DataLabExtContents] [SS] *4SHAPEPROPS End

LD = Legend Begin Pos ATTACHEDLABEL [FRAME] [CrtLayout12] [TEXTPROPS] [CRTMLFRT] End

SERIESFORMAT = Series Begin 4AI *SS (SerToCrt / (SerParent (SerAuxTrend / SerAuxErrBar)))
*(LegendException [Begin ATTACHEDLABEL [TEXTPROPS] End]) End

FRAME = Frame Begin LineFormat AreaFormat [GELFRAME] [SHAPEPROPS] End

AI = BRAI [SeriesText]

ATTACHEDLABEL = Text Begin Pos [FontX] [AlRuns] AI [FRAME] [ObjectLink] [DataLabExtContents]
[CrtLayout12] [TEXTPROPS] [CRTMLFRT] End

SS = DataFormat Begin [Chart3DBarShape] [LineFormat AreaFormat PieFormat] [SerFmt] [GELFRAME]
[MarkerFormat] [AttachedLabel] *2SHAPEPROPS [CRTMLFRT] End

SHAPEPROPS = ShapePropsStream *ContinueFrt12

TEXTPROPS = (RichTextStream / TextPropsStream) *ContinueFrt12

AXS = [IFmtRecord] [Tick] [FontX] *4(AxisLine LineFormat) [AreaFormat] [GELFRAME] *4SHAPEPROPS
[TextPropsStream *ContinueFrt12]

DFTTEXT = [DataLabExt StartObject] DefaultText ATTACHEDLABEL [EndObject]

```

```

DROPBAR = DropBar Begin LineFormat AreaFormat [GELFRAME] [SHAPEPROPS] End

AXM = YMult StartObject ATTACHEDLABEL EndObject

DAT = Dat Begin LD End

GELFRAME = 1*2GelFrame *Continue [PICF]

PICF = Begin PicF End

CRTMLFRT = CrtMlFrt *CrtMlFrtContinue

```

For ABNF rules not listed here, see section [2.1.7.20.6](#). Within the sequence of records specified by the **CUSTOMVIEW** rule (section 2.1.7.20.6) specified in section 2.1.7.20.6, the **Selection** (section [2.4.248](#)), **HorizontalPageBreaks** (section [2.4.142](#)), and **VerticalPageBreaks** (section [2.4.343](#)) records MUST NOT be present.

2.1.7.20.2 Dialog Sheet Substream

The **Dialog Sheet Substream** specifies a **dialog sheet**.

Record sequence [<3><4>](#) **ABNF**:

```

DIALOGSHEETCONTENT = [Uncalced] Index GLOBALS PAGESETUP [HeaderFooter] *BIGNAME
  [DIALOGPROTECTION] DefColWidth Dimensions OBJECTS *HFPicture *Note 1*DIALOGWINDOW
  *DIALOGCUSTOMVIEW [CodeName] [SheetExt] *RECORD12 EOF

DIALOGSHEET = BOF DIALOGSHEETCONTENT

DIALOGPROTECTION = [Protect] [Password]

DIALOGWINDOW = Window2 [Pane] *Selection

DIALOGCUSTOMVIEW = UserSViewBegin *Selection [HorizontalPageBreaks] [VerticalPageBreaks] [Header]
  [Footer] [HCenter] [VCenter] [LeftMargin] [RightMargin] [TopMargin] [BottomMargin] [Pls]
  [Setup] [PrintSize] [HeaderFooter] UserSViewEnd

OBJECTS = *(MSODRAWING *(TEXTOBJECT / OBJ)) [MsoDrawingSelection]

MSODRAWING = MsoDrawing *Continue

OBJ = Obj *Continue

TEXTOBJECT = TxO *Continue

```

For ABNF rules not listed here, see section [2.1.7.20.6](#).

2.1.7.20.3 Globals Substream

The **Globals Substream** specifies global properties and data in a **workbook**.

There MUST be exactly one **Globals Substream** in a **Workbook Stream** (section [2.1.7.20](#)), and the **Globals Substream** MUST be the first substream in the **Workbook Stream**.

Record sequence [<5><6>](#) **ABNF**:

```

WORKBOOKCONTENT = [WriteProtect] [FilePass] [Template] INTERFACE WriteAccess [FileSharing]
CodePage *2047Lel DSF [Excel9File] RRTabId [ObProj] [ObNoMacros] [CodeName] [FNGROUPS]
*Lbl [OLEObjectSize] PROTECTION 1*Window1 Backup HideObj Datel904 CalcPrecision
RefreshAll BookBool FORMATTING *(PIVOTCACHEDEFINITION) [DOCROUTE] *UserBView UsesELFs
1*BUNDLESHEET METADATA [MTRSettings] [ForceFullCalculation] Country *SUPBOOK *LBL *RTD
[RecalcId] *HFPicture *MSODRAWINGGROUP [SHAREDSTRINGS] ExtSST *WebPub [WOpt] [CrErr]
[BookExt] *FeatHdr *DConn [THEME] [CompressPictures] [Compat12] [GUIDTypeLib] EOF

WORKBOOK = BOF WORKBOOKCONTENT

INTERFACE = InterfaceHdr Mms InterfaceEnd

FNGROUPS = BuiltInFnGroupCount *FnGroupName *FnGrp12

PROTECTION = WinProtect Protect Password Prot4Rev Prot4RevPass

FORMATTING = 1*510Font 8*218Format XFS *DXF STYLES [TABLESTYLES] [Palette] [ClrtClient]

XFS = 16*XF [XFCRC 16*4050XFExt]

STYLES = 1*(Style [StyleExt])

TABLESTYLES = TableStyles *(TableStyle *28TableStyleElement)

PIVOTCACHEDEFINITION = SXStreamID SXVS [SXSRC] [SXADDLCACHE]

SXSRC = DREF / SXTBL / DBQUERY

DREF = DConName / DConBin / DConRef

SXTBL = SXTbl *DREF *SxTbpg *(SXTBRGIITM *SXString)

DBQUERY = DbOrParamQry [1*SXString [DbOrParamQry *(SXString DbOrParamQry)]] *SXString

DOCROUTE = DocRoute 1*65535RecipName

BUNDLESHEET = BoundSheet8

METADATA = *MDTINFO *MDXSTR *(MDXTUPLESET / MDXProp / MDXKPI) *MDBLOCK

MDTINFO = MDTInfo *ContinueFrt12

MDXSTR = MDXStr *ContinueFrt12

MDXTUPLESET = (MDXTuple / MDXSet) *ContinueFrt12

MDBLOCK = MDB *ContinueFrt12

SUPBOOK = SupBook [*ExternName *(XCT *CRN)] [ExternSheet] *Continue

LBL = Lbl [NameCmt] [NameFnGrp12] [NamePublish]

RTD = RealTimeData *ContinueFrt

MSODRAWINGGROUP = MsoDrawingGroup *Continue

SHAREDSTRINGS = SST *Continue

THEME = Theme *ContinueFrt12

```

```

SXADDLCACHE = SXAddl SXCCache SXDIId SXAddl SXCCache SXDVer10Info [SXAddl SXCCache SXDVerSXMacro]
              [SXADDLCACHE12] [SXADDLDBQUERY] *UNKNOWNFRT SXAddl SXCCache SXDEnd

SXADDLCACHE12 = SXAddl SXCCache SXDVerUpdInv SXAddl SXCCache SXDIInfo12
                SXAddl SXCCache SXDIInvRefreshReal *SXADDLCACHEFIELD [SXADDLSXDH] [SXADDLSXMGs]
                SXAddl_SXCCache_SXDVerUpdInv

SXADDLSXDH = SXAddl SXCSXDH SXDIId *SXAddl SXCSXDH SXDSxdh SXAddl SXCSXDH SXDEnd

SXADDLSXMGs = SXAddl SXCSXMGs SXDIId *SXADDLSXMG *SXAddl SXCSXMGs SXDMGrpSXDHMap *UNKNOWNFRT
              SXAddl SXCSXMGs SXDEnd

SXADDLSXMG = SXAddl SXCSXMG SXDIId *Continue SxaddlSxString [SXAddl SXCSXMG SXDUserCaption
                  *Continue_SxaddlSxString] *UNKNOWNFRT SXAddl SXCSXMG SXDEnd

SXADDLCACHEFIELD = SXAddl SXCCacheField SXDIId *Continue SxaddlSxString
                  [SXAddl SXCCacheField SXDCaption *Continue_SxaddlSxString]
                  [SXAddl SXCCacheField SXDProperty [SXAddl SXCCacheField SXDPropName
                  *Continue_SxaddlSxString]] [SXAddl SXCCacheField SXDIIfdbMpMapCount
                  SXAddl SXCCacheField SXDIIfdbMempropMap] [SXAddl SXCCacheField SXDSxmitmCount
                  *SXADDLCACHEITEM SXAddl SXCCacheItem SXDEnd] SXAddl SXCCacheField SXDEnd

SXADDLCACHEITEM = SXAddl SXCCacheItem SXDIId [SXAddl SXCCacheItem SXDSxmitmDisp
                  *Continue_SxaddlSxString] *(SXAddl SXCCacheItem SXDIItmMpMapCount
                  SXAddl SXCCacheItem SXDIItmMpropMap)

```

2.1.7.20.4 Macro Sheet Substream

The **Macro Sheet Substream** specifies a **macro sheet**. This substream specifies an **international macro sheet** if the **Intl** record (section [2.4.147](#)) is present.

Record sequence [<7>](#) **ABNF**:

```

MACROSHEETCONTENT = [Uncalced] Index [Intl] GLOBALS PAGESETUP [HeaderFooter] [BACKGROUND]
                  *BIGNAME [PROTECTION] COLUMNS MACROSORTANDFILTER Dimensions [CELLTABLE] OBJECTS
                  *HFPicture *Note [DCON] 1*WINDOW *CUSTOMVIEW *2SORT [DxGCol] [PHONETICINFO] [CodeName]
                  *CellWatch [SheetExt] *FEAT *RECORD12 EOF

MACROSHEET = BOF MACROSHEETCONTENT

MACROSORTANDFILTER = [Sort] [SORTDATA12] [DropDownObjIds] [AUTOFILTER]

```

For ABNF rules not listed here, see section [2.1.7.20.6](#). **Table** (section [2.4.319](#)) MUST NOT appear under this substream.

2.1.7.20.5 Worksheet Substream

The **Worksheet Substream** specifies a **worksheet**.

Record sequence [<8>](#) **ABNF**:

```

WORKSHEETCONTENT = [Uncalced] Index GLOBALS PAGESETUP [HeaderFooter] [BACKGROUND] *BIGNAME
                  [PROTECTION] COLUMNS [SCENARIOS] SORTANDFILTER Dimensions [CELLTABLE] OBJECTS *HFPicture
                  *Note *PIVOTVIEW [DCON] 1*WINDOW *CUSTOMVIEW *2SORT [DxGCol] *MergeCells [LRng]
                  *QUERYTABLE [PHONETICINFO] CONDFMTS *HLINK [DVAL] [CodeName] *WebPub *CellWatch
                  [SheetExt] *FEAT *FEAT11 *RECORD12 EOF

WORKSHEET = BOF WORKSHEETCONTENT

```



```

SXADDLCALCMEMBER = (SXAddl SXCVIEW SXDCalcMember [SXAddl SXCVIEW SXDCalcMemString
*Continue_SxaddlSxString])

SXADDLCONDFFMTS = SXAddl SXCSXCondFmts SXDIID *SXADDLCONDFFMT SXAddl SXCSXCondFmts SXDEnd

SXADDLCONDFFMT = SXAddl SXCSXCondFmt SXDSXCondFmt *SXADDLSXRULE SXAddl SXCSXCondFmt SXDEnd

SXADDLAUTOSORT = SXAddl SXCAutoSort SXDIID SXADDLSXRULE SXAddl SXCAutoSort SXDEnd

SXADDLSXRULE = SXAddl SXCSXrule SXDIID SXAddl SXCSXrule SXDSXrule *SXADDLSXFILT
SXAddl SXCSXrule SXDEnd

SXADDLSXFILT = SXAddl SXCSXfilt SXDIID SXAddl SXCSXfilt SXDSXfilt [SXAddl SXCSXfilt SXDSXitm]
SXAddl SXCSXfilt SXDEnd

SXADDLSXFILTERS12 = SXAddl SXCSXFilters12 SXDIID *SXADDLSXFILTER12 SXAddl SXCSXFilters12 SXDEnd

SXADDLSXFILTER12 = SXAddl SXCSXFilter12 SXDIID SXAddl SXCSXFilter12 SXDSXFilter
[SXAddl SXCSXFilter12 SXDCaption *Continue_SxaddlSxString]
[SXAddl SXCSXFilter12 SXDSXFilterDesc *Continue_SxaddlSxString]
[SXAddl SXCSXFilter12 SXDSXFilterValue1 *Continue_SxaddlSxString]
[SXAddl SXCSXFilter12 SXDSXFilterValue2 *Continue_SxaddlSxString]
SXAddl SXCSXFilter12 SXDXlsFilter [SXAddl SXCSXFilter12 SXDXlsFilterValue1
*Continue_SxaddlSxString] [SXAddl SXCSXFilter12 SXDXlsFilterValue2
*Continue_SxaddlSxString] SXAddl SXCSXFilter12 SXDEnd

SXADDLFIELD = [SXAddl SXCFIELD SXDIID *Continue_SxaddlSxString SXAddl SXCFIELD SXDVer10Info
SXAddl SXCFIELD SXDEnd] [SXADDLFIELD12]

SXADDLFIELD12 = SXAddl SXCFIELD12 SXDIID *Continue_SxaddlSxString SXAddl SXCFIELD12 SXDVer12Info
SXAddl SXCFIELD12 SXDVerUpdInv [SXAddl SXCFIELD12 SXDMemberCaption
*Continue_SxaddlSxString] [SXAddl SXCFIELD12 SXDAutoShow] [SXAddl SXCFIELD12 SXDISXTH]
[SXADDLAUTOSORT] SXAddl_SXCFIELD12_SXDVerUpdInv *UNKNOWNFRT SXAddl SXCFIELD12 SXDEnd

SXADDLHIERARCHY = SXAddl SXCHierarchy SXDIID *Continue_SxaddlSxString
*SXAddl SXCHierarchy SXDProperty *SXADDLGRPLEVEL [SXAddl SXCHierarchy SXDVerUpdInv]
*SXAddl SXCHierarchy SXDFilterMember [SXAddl_SXCHierarchy_SXDVerUpdInv]
[SXAddl SXCHierarchy SXDSXSetParentUnique *Continue_SxaddlSxString]
[SXAddl SXCHierarchy SXDIIconSet] [SXAddl SXCHierarchy SXDUserCaption
*Continue_SxaddlSxString] *UNKNOWNFRT [SXAddl_SXCHierarchy_SXDVerUpdInv]
*SXAddl SXCHierarchy SXDFilterMember12 [SXAddl_SXCHierarchy_SXDVerUpdInv]
[SXAddl SXCHierarchy SXDInfo12] [SXAddl SXCHierarchy SXDDisplayFolder
*Continue_SxaddlSxString] [SXAddl SXCHierarchy SXDMeasureGrp *Continue_SxaddlSxString]
[SXAddl SXCHierarchy SXDParentKPI *Continue_SxaddlSxString]
[SXAddl SXCHierarchy SXDKPIValue *Continue_SxaddlSxString]
[SXAddl SXCHierarchy SXDKPIGoal *Continue_SxaddlSxString]
[SXAddl SXCHierarchy SXDKPIStatus *Continue_SxaddlSxString]
[SXAddl SXCHierarchy SXDKPI_Trend *Continue_SxaddlSxString]
[SXAddl SXCHierarchy SXDKPIWeight *Continue_SxaddlSxString]
[SXAddl SXCHierarchy SXDKPITime *Continue_SxaddlSxString] SXAddl_SXCHierarchy_SXDEnd

SXADDLGRPLEVEL = SXAddl SXCGrpLevel SXDIID *Continue_SxaddlSxString
SXAddl SXCGrpLevel SXDGrpLevelInfo *SXADDLGROUP *UNKNOWNFRT SXAddl SXCGrpLevel SXDEnd

SXADDLGROUP = SXAddl SXCGroup SXDIID *Continue_SxaddlSxString SXAddl SXCGroup SXDGrpInfo
*SXAddl SXCGroup SXDMember *UNKNOWNFRT SXAddl SXCGroup SXDEnd

```

For ABNF rules not listed here, see the [Common Productions](#) section.

2.1.7.20.6 Common Productions

Record sequence fragments that are common to multiple substreams are specified here. If a fragment cannot be found under its part, look for it in this record sequence [<9><10><11>](#) **ABNF**:

GLOBALS = [CalcMode](#) [CalcCount](#) [CalcRefMode](#) [CalcIter](#) [CalcDelta](#) [CalcSaveRecalc](#) [PrintRowCol](#) [PrintGrid](#)
[GridSet](#) [Guts](#) [DefaultRowHeight](#) [WsBool](#) [[Sync](#)] [[LPr](#)] [[HorizontalPageBreaks](#)]
[VerticalPageBreaks](#)]

PAGESETUP = [Header](#) [Footer](#) [HCenter](#) [VCenter](#) [[LeftMargin](#)] [[RightMargin](#)] [[TopMargin](#)] [[BottomMargin](#)]
[Pls](#) *[Continue](#)] [Setup](#)

BACKGROUND = [BkHim](#) *[Continue](#)

BIGNAME = [BigName](#) *[ContinueBigName](#)

PROTECTION = [[Protect](#)] [[ScenarioProtect](#)] [[ObjProtect](#)] [[Password](#)]

COLUMNS = [DefColWidth](#) *255[ColInfo](#)

AUTOFILTER = [AutoFilterInfo](#) *([AutoFilter](#) / ([AutoFilter12](#) *[ContinueFrt12](#))) *SORTDATA12

CELLTABLE = 1*(1*[Row](#) *CELL 1*[DBCCell](#)) *[EntExU2](#)

CELL = FORMULA / [Blank](#) / [MulBlank](#) / [RK](#) / [MulRk](#) / [BoolErr](#) / [Number](#) / [LabelSst](#)

FORMULA = [[Uncalced](#)] [Formula](#) [[Array](#) / [Table](#) / [ShrFmla](#) / SUB] [[String](#) *[Continue](#)]

PHONETICINFO = [PhoneticInfo](#) *[Continue](#)

OBJECTS = *(MSODRAWING *(TEXTOBJECT / OBJ)) [[MsoDrawingSelection](#)]

MSODRAWING = [MsoDrawing](#) *[Continue](#)

OBJ = [Obj](#) *[Continue](#) *CHART

CHART = CHARTSHEET *[Continue](#)

TEXTOBJECT = [TxO](#) *[Continue](#)

DCON = [DCon](#) *([DConName](#) / [DConBin](#) / [DConRef](#))

WINDOW = [Window2](#) [[PLV](#)] [[Scl](#)] [[Pane](#)] *[Selection](#)

CUSTOMVIEW = [UserSViewBegin](#) *[Selection](#) [[HorizontalPageBreaks](#)] [[VerticalPageBreaks](#)] [[Header](#)]
[Footer](#)] [[HCenter](#)] [[VCenter](#)] [[LeftMargin](#)] [[RightMargin](#)] [[TopMargin](#)] [[BottomMargin](#)] [[Pls](#)]
[Setup](#)] [[PrintSize](#)] [[HeaderFooter](#)] [AUTOFILTER] [UserSViewEnd](#)

SORT = [RRSort](#) *[Continue](#)

SORTDATA12 = [SortData](#) *[ContinueFrt12](#)

PIVOTRULE = [SxRule](#) *PRFILTER

PRFILTER = [SxFilt](#) [[SxItm](#) *[Continue](#)]

FEAT = [FeatHdr](#) *([Feat](#) *[ContinueFrt](#))

FEAT11 = [FeatHdr11](#) *(([Feature11](#) / [Feature12](#)) *[ContinueFrt11](#) *[List12](#) [[AutoFilter12](#) *[ContinueFrt12](#)]
*[List12](#) [SORTDATA12])

RECORD12 = HeaderFooter

```
SXADDLDBQUERY = [SXAddl SXCQuery SXDXMLSource *Continue SxaddlSxString]
                [SXAddl SXCQuery SXDSrcDataFile *Continue _SxaddlSxString] [SXAddl SXCQuery SXDSrcConnFile
                *Continue _SxaddlSxString] [SXAddl SXCQuery SXDRconnCond] SXAddl SXCQuery SXDEnd
```

UNKNOWNFRT = [SXAddl](#)

2.1.7.21 XML Signatures Storage (_xmldsignatures)

The **XML Signatures Storage** is specified in [\[MS-OFFCRYPTO\]](#) section 2.5.2.

The name of this storage MUST be "_xmldsignatures". A file MUST contain at most one **XML Signatures Storage**[<12>](#).

When generating the **DigestValue**, as specified in [\[XMLDSig\]](#) section 4.3.3.6, the record data, as specified in the **Record** section (section [2.1.4](#)), in the **WriteAccess record** (section [2.4.349](#)) in the **Globals Substream** (section [2.1.7.20.3](#)) is skipped.

2.1.7.22 XML Stream (XML)

The XML **Stream** specifies one or more **XML maps**.

The name of the stream MUST be "XML". A file MUST contain at most one XML **Stream**.

The syntax of the structures contained in this part uses **XML schema definition (XSD)**, as specified in [\[XMLSCHEMA1/2\]](#) and [\[XMLSCHEMA2/2\]](#).

This specification defines and references various **XML namespaces** using the mechanisms specified in [\[XMLNS\]](#).

The content of this stream is **XML** as specified by the following **XML schema**:

```
<?xml version="1.0" encoding="utf-8"?>
<s:schema
  attributeFormDefault="unqualified"
  elementFormDefault="unqualified"
  xmlns:s="http://www.w3.org/2001/XMLSchema">

  <s:element name="MapInfo">
    <s:complexType>
      <s:sequence>
        <s:element name="Schema" maxOccurs="unbounded">
          <s:complexType>
            <s:sequence>
              <s:any processContents="skip" />
            </s:sequence>
            <s:attribute name="ID" type="ST_Xstring65535" use="required" />
            <s:attribute name="SchemaRef" type="ST_Xstring65535" />
            <s:attribute name="Namespace" type="ST_Xstring65535" />
          </s:complexType>
        </s:element>
      <s:element name="Map" maxOccurs="unbounded">
        <s:complexType>
          <s:sequence>
            <s:element name="DataBinding" minOccurs="0">
              <s:complexType>
                <s:sequence>
                  <s:any minOccurs="0" processContents="skip" />
                </s:sequence>
                <s:attribute name="DataBindingName" type="ST_Xstring65535" />
                <s:attribute name="FileBinding" type="ST_Xstring65535"
                  use="required" />
              </s:complexType>
            </s:element>
          </s:sequence>
        </s:complexType>
      </s:element>
    </s:sequence>
  </s:complexType>
</s:element>
</s:schema>
```

```

        <s:attribute name="FileBindingName" type="ST_Xstring65535" />
        <s:attribute name="DataBindingLoadMode"
            type="ST_DataBindingLoadMode" use="required" />
    </s:complexType>
</s:element>
</s:sequence>
<s:attribute name="ID" type="ST_XmlMapId" use="required" />
<s:attribute name="Name" type="ST_Xstring256" use="required" />
<s:attribute name="RootElement" type="ST_Xstring65535"
    use="required" />
<s:attribute name="SchemaID" type="ST_Xstring65535" use="required" />
<s:attribute name="ShowImportExportValidationErrors"
    type="ST_XmlMapBoolean" use="required"/>
<s:attribute name="AutoFit" type="ST_XmlMapBoolean" use="required" />
<s:attribute name="Append" type="ST_XmlMapBoolean" use="required" />
<s:attribute name="PreserveSortAFLayout" type="ST_XmlMapBoolean"
    use="required" />
<s:attribute name="PreserveFormat" type="ST_XmlMapBoolean"
    use="required" />
</s:complexType>
</s:element>
</s:sequence>
<s:attribute name="SelectionNamespaces" type="ST_Xstring65535"
    use="required"/>
</s:complexType>
</s:element>

<s:simpleType name="ST_DataBindingLoadMode">
    <s:restriction base="s:unsignedInt">
        <s:enumeration value="0" />
        <s:enumeration value="1" />
        <s:enumeration value="2" />
        <s:enumeration value="3" />
        <s:enumeration value="4" />
    </s:restriction>
</s:simpleType>

<s:simpleType name="ST_XmlMapBoolean">
    <s:restriction base="s:string">
        <s:enumeration value="false" />
        <s:enumeration value="true" />
    </s:restriction>
</s:simpleType>

<s:simpleType name="ST_XmlMapId">
    <s:restriction base="s:unsignedInt">
        <s:minInclusive value="1" />
        <s:maxInclusive value="2147483647" />
    </s:restriction>
</s:simpleType>

<s:simpleType name="ST_Xstring65535">
    <s:restriction base="s:string" />
</s:simpleType>

<s:simpleType name="ST_Xstring256">
    <s:restriction base="s:string" />
</s:simpleType>

</s:schema>

```

2.1.7.22.1 Elements

The following table specifies the **XSD** elements that are specific to the **XML Stream** (section [2.1.7.22](#)):

Element	Description
MapInfo (section 2.1.7.22.1.1)	This element specifies a container for all of the XML schemas and XML maps attached to workbook.
Schema (section 2.1.7.22.1.2)	This element specifies an XML schema associated with an XML map.
Map (section 2.1.7.22.1.3)	This element specifies an XML map and the behaviors expected during refresh operations.
DataBinding (section 2.1.7.22.1.4)	This element specifies a connection to an XML file data source that is used when the XML map is refreshed.

2.1.7.22.1.1 MapInfo

The **MapInfo** element specifies a container for all of the **XML schemas** and **XML maps** attached to workbook.

SelectionNamespaces: An **ST_Xstring65535** (section [2.1.7.22.2.4](#)) that specifies the **XML namespace** for use in **XPath** expressions.

2.1.7.22.1.2 Schema

The **Schema** element specifies an **XML schema** associated with an **XML map**. The contents of this element MUST be an **XSD**, as specified in [\[XMLSCHEMA1/2\]](#) and [\[XMLSCHEMA2/2\]](#).

ID: An **ST_Xstring65535** that specifies the unique name for this attached XML schema.

Namespace: An **ST_Xstring65535** that specifies the **XML namespace** used by the XML schema.

SchemaRef: An **ST_Xstring65535** that specifies the other **Schema elements** in this parent **MapInfo** element (section [2.1.7.22.1.1](#)) that contain XML schemas that the XML schema for this **Schema** element is dependent on. The value MUST specify the dependent **Schema** elements by **ID** in a space-delimited list. The **SchemaRef** attribute MUST be absent or the value MUST be empty if there are no dependencies.

2.1.7.22.1.3 Map

The **Map** element specifies an **XML map** and the behaviors expected during **refresh** operations.

Append: An **ST_XmlMapBoolean** (section [2.1.7.22.2.2](#)) that specifies whether **XML** data overwrites or is appended to the **table** or **range** of cells associated with the XML map on refresh.

AutoFit: An **ST_XmlMapBoolean** that specifies whether columns are resized to fit the XML data after a refresh operation.

ID: An **ST_XmlMapId** (section [2.1.7.22.2.3](#)) that specifies the identifier of the XML map.

Name: An **ST_Xstring256** (section [2.1.7.22.2.5](#)) that specifies the name of the XML map. **Name** MUST be unique for each **Map**.

PreserveFormat: An **ST_XmlMapBoolean** that specifies whether **number formats** in the **sheet (1)** are preserved during refresh or whether the number formats specified by the **XML schema** are used.

PreserveSortAFlayout: An **ST_XmlMapBoolean** that specifies whether to reapply the **filtering state** of the table after a refresh.

RootElement: An **ST_Xstring65535** (section [2.1.7.22.2.4](#)) that specifies the name of the root XML element.

SchemaID: An **ST_Xstring65535** that specifies the name of the XML schema used for the XML map. **SchemaID** MUST equal the **ID** attribute of a **Schema** element (section [2.1.7.22.1.2](#)) contained within the parent **MapInfo** element (section [2.1.7.22.1.1](#)).

ShowImportExportValidationErrors: An **ST_XmlMapBoolean** that specifies whether validation errors are displayed during refresh or data export.

2.1.7.22.1.4 DataBinding

The **DataBinding** element specifies a connection to an **XML** file **data source** that is used when the **XML map** is refreshed.

DataBindingLoadMode: An **ST_DataBindingLoadMode** (section [2.1.7.22.2.1](#)) that specifies the method for loading XML data.

DataBindingName: An **ST_Xstring65535** that specifies the name for this connection. **DataBindingName** MUST be unique for each **DataBinding** element.

FileBinding: An **ST_Xstring65535** that specifies the XML file data source used for **refresh**. **FileBinding** MUST NOT be "true" or "false".

FileBindingName: An **ST_Xstring65535** that specifies the name for the XML file data source. **FileBindingName** MUST be unique for each **DataBinding** element.

2.1.7.22.2 Simple Types

The following table specifies the **XSD** simple types that are specific to the **XML Stream** (section [2.1.7.22](#)):

Element	Description
ST_DataBindingLoadMode (section 2.1.7.22.2.1)	This simple type specifies the method for loading XML data related to a DataBinding element (section 2.1.7.22.1.4).
ST_XmlMapBoolean (section 2.1.7.22.2.2)	This simple type specifies Boolean values.
ST_XmlMapId (section 2.1.7.22.2.3)	This simple type is an integral value that specifies the identifier of an XML map (section 2.1.7.22.1.3) in the XML Stream (section 2.1.7.22).
ST_Xstring65535 (section 2.1.7.22.2.4)	This simple type is a string that MUST NOT exceed 65,535 Unicode characters.
ST_Xstring256 (section 2.1.7.22.2.5)	This simple type is a string that MUST NOT exceed 256 Unicode characters.

2.1.7.22.2.1 ST_DataBindingLoadMode

The **ST_DataBindingLoadMode** simple type specifies the method for loading **XML** data related to a **DataBinding** element (section [2.1.7.22.1.4](#)).

The following are possible enumeration values for this type:

Enumeration Value	Description
0	None.
1	Normal.
2	Delay Load.
3	Asynchronous.

4	Object Model.
---	---------------

2.1.7.22.2.2 ST_XmlMapBoolean

The **ST_XmlMapBoolean** simple type defines **Boolean** values (section [2.5.14](#)).

The following are possible enumeration values for this type:

Enumeration Value	Description
false	False Boolean value.
true	True Boolean value.

2.1.7.22.2.3 ST_XmlMapId

The **ST_XmlMapId** simple type is an integral value that specifies the identifier of an **XML map** (section [2.1.7.22.1.3](#)) in the **XML Stream** (section [2.1.7.22](#)). **ST_XmlMapId** MUST be greater than or equal to 1 and less than or equal to 2147483647.

2.1.7.22.2.4 ST_XmlString65535

The **ST_XmlString65535** simple type is a string that MUST NOT exceed 65,535 **Unicode** characters.

2.1.7.22.2.5 ST_XmlString256

The **ST_XmlString256** simple type is a string that MUST NOT exceed 256 **Unicode** characters.

2.2 Conceptual Overview

This section specifies how higher-level features of the file format are represented by combinations of records.

2.2.1 Cell Table

Text, formulas, and numerical data within **workbooks** are primarily stored in the cells that make up **worksheets** (section [2.1.7.20.5](#)) and **macro sheets** (section [2.1.7.20.4](#)). Cells are the fundamental building blocks that contain data, formulas, and formatting to form the workbook. The data structure associated with the grid of cells is called the **cell table**.

The cell table is stored in the sequence of records that conform to the **CELLTABLE** rule (section [2.1.7.20.6](#)) within the Common Productions **ABNF**. The cell table consists of a series of row blocks. From the first row containing data to the last row containing data, every 32 consecutive rows, including blank rows, comprise a row block.

The number of row blocks in a **sheet (1)** is specified by the following algorithm that uses fields from the **Dimensions** record (section [2.4.90](#)):

```

if ((rwMac -rwMic) % 32 == 0)
    number of row blocks = (rwMac -rwMic) / 32
else
    number of row blocks = (rwMac -rwMic) / 32 + 1

```

Within each row block, a **Row** record (section [2.4.221](#)) is saved for each row that contains data or row formatting. For each such row, every **cell** that contains data or individual cell formatting is represented by a record. Formatting information for a cell can be derived from individual cell formatting, row formatting, column formatting, or the default cell format as specified by the **XFI** structure (section [2.5.282](#)). The order of precedence for formatting is individual cell formatting with the highest precedence, followed by row formatting, and then column formatting, and then the default cell format. Cells that do not contain data and do not contain individual formatting are not saved.

Cells are specified by any of the records specified in the **CELL** rule (section 2.1.7.20.6). Multiple cells can be represented by one record—for example, a **MulBlank** record (section [2.4.174](#)) specifies a series of blank cells. Note that blank cells are only included when they contain individual cell formatting. Rows are saved in increasing order, and cells are saved in row-major order.

The order of the records that comprise a row block begins with a series of **Row** records (a maximum of 32 such records), followed by the records representing the cells, followed by the **DBCell** record (section [2.4.78](#)). A cell in the cell table is referred to by its row and column indexes, which are zero-based. The maximum row index is 65535. The maximum column index is 255.

The bounding box of the non-empty cells is stored in the **Dimensions** record. Information that applies to each column is specified in the **COLUMNS** collection (section 2.1.7.20.6).

2.2.1.1 Retrieval of Last-Calculated Cell Values Without Loading Cell Table

The only way to retrieve formulas, formats and other cell data is to read the cell table normally as defined earlier. However, in certain situations (for example when resolving external references to values) it is beneficial to retrieve only the last calculated value from a cell, without actually loading the cell table. To improve the performance of a random read access to the values in the **cell table** (section [2.2.1](#)), **BIFF** provides **Index** (section [2.4.144](#)) and **DBCell** (section [2.4.78](#)) records. To find a particular **cell** value, an application can perform the following:

1. Read **Index** records to find one such that the cell row is greater or equal to **rwMic** and less than **rwMac**.
2. Compute the data offset of the required **DBCell** record according to the description of the **Index** record.
3. Read the **DBCell** record (section 2.4.78) in the obtained position, and compute the data offset of the cell row according to the following:
 1. The file position of the first non-empty **Row** (section [2.4.221](#)) in a row block is equal to the file position of the **DBCell** record—the **dbRtrw** field of **DBCell** record.
 2. The file position of the first **CELL** record (section [2.1.7.20.6](#)) for the first non-empty **Row** (section 2.4.221) is equal to the file position of the second **Row** record (the end of the first **Row** record) + **rgdb[0]**. Other non-empty **CELL** records for the first row follow this first **CELL** record.
 3. The file position of the first **CELL** record for the second non-empty **Row** is equal to the file position of the first **CELL** record for the first **Row** + **rgdb[1]**. Other non-empty **CELL** records for the 2nd row follow this first **CELL** record.
 4. The file position for the first **CELL** record for the third non-empty **Row** is equal to the file position of the first **CELL** record for the second **Row** + **rgdb[2]**.
4. Read cell table data starting from the previously computed position.

Note that if the **Row** of the **CELL** record is known, it is possible to calculate the file position of the first **CELL** record of that **Row** first, and then get all the following **CELL** records without going through the first **Row**, the second **Row**, and so on.

2.2.2 Formulas

A formula is sequence of values, cell references, names, functions, or operators in a cell that together produce a new value. **Formulas** are stored in a tokenized representation known as "parsed expressions." In this section, formula is a synonym for parsed expression. A parsed expression is converted into a textual formula at runtime for display and user editing. Cell formulas are specified by the **Formula** record (section [2.4.127](#)). Array formulas are specified by the **Array** record (section [2.4.4](#)). Shared formulas are specified by the **ShrFmla** record (section [2.4.260](#)).

Formulas that are part of a **revision** as specified in the Shared Workbooks overview (section [2.2.11](#)) are specified by the **pe.rgce** field or the **peOld.rgce** field of the **RRDDefName** record (section [2.4.225](#)), or by the **xpe.rgce** field or the **xpeOld.rgce** field of the **RRDChgCell** record (section [2.4.223](#)).

A parsed **expression** contains a sequence of parse tokens, each of which is either an **operand** token (section [2.2.2.2](#)), an **operator** token (section [2.2.2.1](#)), a **control** token (section [2.2.2.3](#)), a **display** token (section [2.2.2.4](#)), or a **mem** token (section [2.2.2.5](#)). All tokens are stored as Parse Things (**Ptg** (section [2.5.198.25](#))).

With the exception of **control** tokens (section 2.2.2.3), **display** tokens (section 2.2.2.4), and **mem** tokens (section 2.2.2.5) that are described in subsequent sections, parsed expressions are stored in **Rgce** (section [2.5.198.104](#)) using Reverse-Polish notation. Reverse-Polish notation is a logical system for the specification of mathematical formulas in which operands are followed by operators. Inside an **Rgce**, the operands and operators are represented by an array of **Ptg** structures (section 2.5.198.25) of variable lengths. The first one or two bytes of a **Ptg** structure (section 2.5.198.25) contain the token type that determines which specific **Ptg** type (section 2.5.198.25) the **Ptg** is, as specified in the **Ptg** structure. The remainder of the structure varies according to the token type.

Evaluation of a formula specified in Reverse-Polish notation is usually based around an evaluation stack. The expression is parsed from beginning to end, and operands are pushed onto the stack as they are encountered. When operators are encountered, the required number of operands is popped from the stack and the result of the operation is pushed back onto the stack. Evaluation begins with an empty stack, and when the evaluation is finished, there will be exactly one value left on the stack. The value is the result of the evaluation. Subsequent subsections refer to a stack as described by this model.

2.2.2.1 Operator Tokens

Unary Operator Tokens

Unary Operator Tokens specify operations that are performed on the previous element in the grammar specified by **Rgce** (section [2.5.198.104](#)). For example, **PtgPercent** (section [2.5.198.81](#)) divides the last expression on the stack by 100.

Binary Operator Tokens

Binary Operator Tokens specify operations that are performed on the previous two elements in the grammar specified by **Rgce**. For example, **PtgIsect** (section [2.5.198.67](#)), which intersects the topmost two expressions on the stack.

2.2.2.2 Operand Tokens

Operand Tokens represent values and references that are used by operators and functions. Operands fall into one of two classes, **reference class** (section [2.2.2.2.2](#)), or **value class** (section [2.2.2.2.1](#)), depending on what result type the formula expects from the operand.

2.2.2.2.1 Value Class

Value Class is the most common type of operand, and represents a single value or array of values. When **Ptg records** (section [2.5.198.25](#)) with reference contents are used by an operator that requires **Value Class** operands, the **Ptg records** can be stored as **Value Class** operands rather than **reference class** (section [2.2.2.2](#)) operands. For example, in a formula where the contents of A1 is added to the integer value 1, the value of **cell** A1 is pushed onto the stack as a **Value Class** operand **PtgRef** (section [2.5.198.84](#)) because the subsequent **PtgAdd** operator (section [2.5.198.26](#)) requires **Value Class** operands. Arrays are stored in a similar fashion. For example, when adding the array of values {1,2,3,4,5,6}, the values are stored in a **PtgArray** operand (section [2.5.198.32](#)).

2.2.2.2.2 Reference Class

When operands are stored as **Reference Class** operands, any references contained in the operand are not de-referenced and do not return the underlying value or values. They are pushed onto the stack in reference form.

2.2.2.3 Control Tokens

Control Tokens do not perform operations or push values onto the stack. Conditional **Control Tokens** (**PtgAttrIf** (section [2.5.198.36](#)), **PtgAttrChoose** (section [2.5.198.34](#)), and **PtgAttrGoto** (section [2.5.198.35](#))) are used at runtime to prescribe short-circuit evaluation inside conditional functions and can be ignored when converting parsed expressions into textual formulas.

2.2.2.4 Display Tokens

Display Tokens, like **Control Tokens** (section [2.2.2.3](#)), do not perform operations or push values onto the stack. **Display** Tokens (**PtgParen** (section [2.5.198.80](#) and **PtgAttrSpace** (section [2.5.198.38](#))) are used at runtime to represent parentheses and space characters in a formula when parsed expressions are converted into textual formulas. **Display** Tokens do not affect the order of operations of the formula.

2.2.2.5 Mem Tokens

Mem Tokens have two purposes: they cache the results of **reference class expressions** (section [2.2.2.2](#)) and they can return the results of **reference class expressions** (section [2.2.2.2](#)) as **value class expressions** (section [2.2.2.1](#)). **Mem** Tokens act on **binary-reference-expressions** (section [2.5.198.104](#)) that follow them in a **mem-area-expression** (section [2.5.198.104](#)).

2.2.2.6 Formula Elements

Some **Ptg records** (section [2.5.198.25](#)) require extra data that is not stored in the **Rgce** (section [2.5.198.104](#)). When an **Rgce** contains one or more of these **Ptg records**, the containing formula structure includes an **RgbExtra** (section [2.5.198.103](#)) containing the data for those **Ptg records**. The size of these components is specified by the **RgbExtra** structures. The **Ptg records** do not contain an offset into the **RgbExtra** for their data. The **Ptg records** that require a corresponding structure in **RgbExtra** are specified in section [2.5.198.103](#).

2.2.3 Charts

The following diagram identifies the major aspects of the file format representation of a chart.

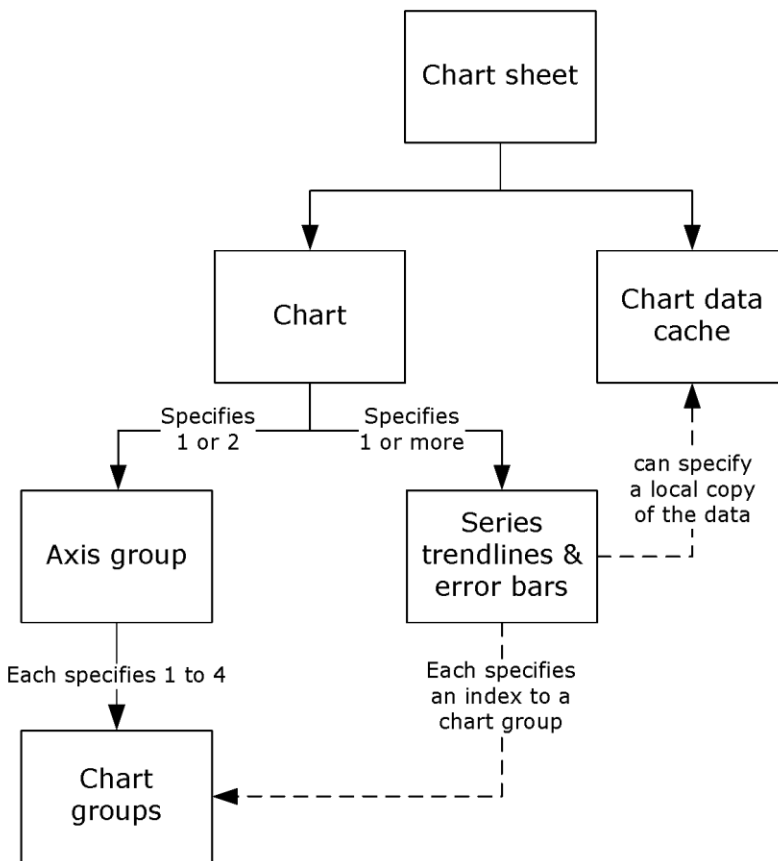

Figure 1: High-level structure of a chart

The **chart sheet** (section [2.2.3.1](#)) specifies a **chart** (section [2.2.3.3](#)), a graphic that displays data or the relationships between sets of data in a visual form, and a **chart data cache** (section [2.2.3.2](#)), a local copy of the data that is used if the **chart** data is missing or if links to external **data sources** are broken. The **chart** specifies one or two **axis groups** (section [2.2.3.5](#)), a set of **axes** (section [2.2.3.6](#)) the **chart** data is plotted against, and the set of **series** (section [2.2.3.9](#)), **trendlines** (section [2.2.3.12](#)), and **error bars** (section [2.2.3.13](#)) specified in the **chart**. Each **axis groups** specifies one to four **chart groups** (section [2.2.3.7](#)) that specify the type of visualization used to display the data. Each **series**, **trendline**, and **error bar** specifies a **chart group** it is associated with.

2.2.3.1 Chart Sheet

A **chart sheet** is a set of data and the **chart** (section [2.2.3.3](#)) that displays the data. There are two types of **chart sheets**: embedded **chart sheets**, and chart sheets that are not embedded.

A **chart sheet** that is not embedded is a separate **sheet (1)** in the **workbook** that is intended to display a **chart**. An embedded **chart sheet** is the logical container for a **chart** displayed on a **worksheet**.

A **chart sheet** is specified by the **chart sheet substream** (section [2.1.7.20.1](#)).

The **chart sheet substream** for an embedded **chart sheet** is contained within a **worksheet substream** (section [2.1.7.20.5](#)). A chart sheet that is not embedded is specified by a **chart sheet substream** that is not contained in another substream.

The following records and rules specify the significant parts of a **chart sheet**:

- The **SheetExt** record (section [2.4.259](#)) specifies properties of the sheet (1) containing the **chart**. If the **chart sheet** is embedded, the **SheetExt** record MUST NOT exist.
- The **WebPub** record (section [2.4.344](#)) specifies properties of a **chart sheet** that has been published to the web.
- The sequences of records that conform to the **PAGESETUP** rule (section [2.1.7.20.6](#)) and **BACKGROUND** rule (section [2.1.7.20.6](#)) and the **HFPicture** (section [2.4.138](#)), **PrintSize** (section [2.4.204](#)), and **HeaderFooter** (section [2.4.137](#)) records specify information about how the **chart** is printed.
- The **Fbi** (section [2.4.109](#)) and **Fbi2** (section [2.4.110](#)) records specify properties used for **font** scaling on the **chart**.
- The **Palette** (section [2.4.188](#)) and **ClrClient** (section [2.4.50](#)) records specify properties of the **color palettes** used in the **chart sheet**.
- The sequence of records that conforms to the **PROTECTION** rule (section [2.1.7.20.6](#)) and the **WriteProtect** record (section [2.4.350](#)) specify **protection** settings for the **chart**. If the chart sheet is embedded, the **WriteProtect** record MUST NOT exist.
- The **SXViewLink** (section [2.4.316](#)), **PivotChartBits** (section [2.4.196](#)), and **SBaseRef** (section [2.4.242](#)) records specify the **PivotTable** (section [2.2.5](#)) that is the data source for this **chart**. If the **chart** is not a **Pivot Chart** (section [2.2.3.4](#)) these records MUST be ignored.
- The sequence of records that conforms to the **OBJECTS** rule (section [2.1.7.20.6](#)) and the **MsoDrawingGroup** record (section [2.4.171](#)) specify the drawing objects on the **chart**
- The sequence of records that conforms to the **CHARTFOMATS** rule (section [2.1.7.20.6](#)) specifies the **chart** that is contained in the **chart sheet**.
- The sequence of records that conforms to the **SERIESDATA** rule (section [2.1.7.20.6](#)) specifies the **chart data cache** (section [2.2.3.2](#)).
- The sequences of records that conform to the **WINDOW** rule (section [2.1.7.20.6](#)) and **CUSTOMVIEW** rule (section [2.1.7.20.6](#)) specify the sheet (1) that contains the **chart**. If the **chart sheet** is not embedded, at least one sequence of records that conform to the **WINDOW** rule MUST exist. If the **chart sheet** is embedded, a sequence of records that conforms to the **WINDOW** rule and **CUSTOMVIEW** rule MUST NOT exist.
- The sequence of records that conforms to the **CRTMFRT** rule (section [2.1.7.20.6](#)) specifies **future records** (section [2.1.6](#)) for the **chart sheet**.

2.2.3.2 Chart Data Cache

A **chart data cache** is a local copy of the data for a **chart** (section [2.2.3.3](#)). The **chart data cache** is used if data is missing or if links to external **data sources** are broken.

A **chart data cache** is specified by a sequence of records that conforms to the **SERIESDATA** rule (section [2.1.7.20.1](#)) specified by the **chart sheet substream** (section [2.1.7.20.1](#)) **ABNF**.

The following records and rules specify the significant parts of a **chart data cache**:

- The **Dimensions** record (section [2.4.90](#)) specifies the cells that contain data used by this **chart**.
- The **SIIndex** record (section [2.4.262](#)) specifies the beginning of a sequence of records that contains a cache of the data for the sequence of records that conforms to a specific **AI** rule (section [2.1.7.20.1](#)) in the **series** (section [2.2.3.12](#)) and **error bars** (section [2.2.3.13](#)). The relationship between the **series** and the chart data cache is specified as follows:

- The first **SIIndex** record in the **chart sheet substream**, which MUST contain a **numIndex** field equal to 0x0001, corresponds to the second sequence of records that conforms to the **AI** rule.
- The second **SIIndex** record in the **chart sheet substream**, which MUST contain a **numIndex** field equal to 0x0002, corresponds to the third sequence of records that conforms to the **AI** rule.
- The third **SIIndex** record in the **chart sheet substream**, which MUST contain a **numIndex** field equal to 0x0003, corresponds to the fourth sequence of records that conforms to the **AI** rule.
- The **Number** (section [2.4.180](#)), **BoolErr** (section [2.4.24](#)), **Blank** (section [2.4.20](#)), and **Label** (section [2.4.148](#)) records each specify an individual value stored in the cache. Each column in the cache corresponds to a **series** or **error bar**, where the zero-based index of the column, specified by the **cell.col** field in the **Number**, **BoolErr**, **Blank**, or **Label** records, equals the zero-based index of the **Series** record (section [2.4.252](#)) in the collection of **Series** records that corresponds to the **series** or **error bar**.

The following restrictions apply to the **chart data cache**:

- The **chart data cache** MUST contain data that corresponds to a sequence of records that conforms to the **AI** rule in a **series** if the corresponding data is not specified in the **chart** or on the same **sheet (1)** as the **chart**.
- The **chart data cache** MUST NOT contain data that corresponds to a sequence of records that conforms to the **AI** rule in a **series** if the corresponding data is specified in the **chart** or on the same sheet (1) as the **chart**.
- The **chart data cache** MUST NOT contain data that corresponds to the third or fourth sequence of records that conforms to the **AI** rule in an **error bar**.
- If the **ebsrc** field of the **SerAuxErrBar** record (section [2.4.249](#)) in an **error bar** equals 0x04, the **chart data cache** MUST contain data that corresponds to the second sequence of records that conforms to the **AI** rule in the **error bar**.
- If the **ebsrc** field of the **SerAuxErrBar** record in an error bar does not equal 0x04, the **chart data cache** MUST NOT contain data that corresponds to the second sequence of records that conforms to the **AI** rule in the **error bar**.
- The **chart data cache** MUST NOT contain data that corresponds to a **trendline** (section [2.2.3.12](#)).

2.2.3.3 Chart

A **chart** is a graphic that displays data or the relationships between sets of data in a visual form. A **chart** element is an item within the chart such as an **axis** (section [2.2.3.6](#)), **legend** (section [2.2.3.8](#)), **series** (section [2.2.3.9](#)), **data point** (section [2.2.3.10](#)), **data label** (section [2.2.3.11](#)), **trendline** (section [2.2.3.12](#)), **error bar** (section [2.2.3.13](#)), or **data table** (section [2.2.3.14](#)).

A **chart data cache** (section [2.2.3.2](#)) is specified by a sequence of records that conforms to the **CHARTFORMATS** rule (section [2.1.7.20.1](#)) specified by the **chart sheet substream** (section [2.1.7.20.1](#)) **ABNF**.

A **chart** can contain the following records and rules that specify the parts of the **chart**:

- The **Chart** record (section [2.4.45](#)) specifies the position and size of the **chart area** (section [2.2.3.17](#)) for a non-embedded chart.
- The sequence of records that conforms to the **FONTLIST** rule (section [2.1.7.20.1](#)) specifies **font** information for the **chart**.

- The **Scl** record (section [2.4.247](#)) specifies the **zoom level** of the current view in the window used to display the **chart**.
- The **PlotGrowth** record (section [2.4.198](#)) specifies font scaling for the text on the **chart**.
- The sequence of records that conforms to the **FRAME** rule (section 2.1.7.20.1) specifies formatting of the chart area (section 2.2.3.17).
- The sequence of records that conforms to the **SERIESFORMAT** rule (section 2.1.7.20.1) specifies the **series**, **trendlines**, and **error** on the **chart**.
- The sequences of records that conform to the **SS** rule (section 2.1.7.20.1) specify properties of the **data labels**, **series**, **data points**, **trendlines**, and **error bars** on the **chart**. These records MUST NOT exist if the **chart sheet substream** contains a **Series** record (section [2.4.252](#)). See the **data label** overview for additional restrictions on these collections of records.
- The sequences of records that conform to the **DFTTEXT** rule (section 2.1.7.20.1) and **TEXTPROPS** rule (section 2.1.7.20.1) specify default properties of the text in the **chart**. The **DataLabExt** (section [2.4.75](#)), **StartObject** (section [2.4.267](#)), and **EndObject** (section [2.4.101](#)) records MUST NOT exist in these sequences of records that conform to the **DFTTEXT** rule (section 2.1.7.20.1).
- The **AxesUsed** record (section [2.4.10](#)) and the sequence of records that conforms to the **AXISPARENT** rule (section 2.1.7.20.1) specify the **axis groups** (section [2.2.3.5](#)) of the **chart**.
- The **CrtLayout12A** record (section [2.4.67](#)) specifies layout information for the **plot area**.
- The sequence of records that conforms to the **DAT** rule (section 2.1.7.20.1) specifies the **data table** for the **chart**.
- The sequence of records that conforms to the **ATTACHEDLABEL** rule (section 2.1.7.20.1) specifies the chart title. This sequence of records MUST have an **ObjectLink** record (section [2.4.182](#)) where the **wLinkObj** field has a value of 0x0001.
- The sequence of records that conforms to the **ATTACHEDLABEL** rule and is preceded by the optional **DataLabExt** record specifies properties of series and data point **data labels**. This sequence of records MUST have an **ObjectLink** record where the **wLinkObj** field has a value of 0x0004. See the **data label** overview for additional information and restrictions on this collection of records.
- The sequence of records that conforms to the **CRTMLFRT** rule (section 2.1.7.20.1) specifies **future records** (section [2.1.6](#)) for the **chart**.

2.2.3.4 Pivot Chart

A **Pivot Chart** is a **chart** (section [2.2.3.3](#)) that uses a **PivotTable** (section [2.2.5](#)) as a **data source**. The **SXViewLink** (section [2.4.316](#)), **PivotChartBits** (section [2.4.196](#)), and **SBaseRef** (section [2.4.242](#)) records in the **chart sheet** (section [2.2.3.1](#)) specify the **PivotTable**.

2.2.3.5 Axis Group

An **axis group** is a set of **axes** (section [2.2.3.6](#)) that specify a coordinate system, a set of **chart groups** (section [2.2.3.7](#)) that are plotted using these **axes** and the **plot area** that defines where the **axes** are rendered on the **chart** (section [2.2.3.3](#)).

An **axis group** is specified by a sequence of records that conforms to the **AXISPARENT** rule (section [2.1.7.20.1](#)) specified by the **chart sheet substream** (section 2.1.7.20.1) **ABNF**.

The following records and rules define the significant parts of an **axis group**:

- The **AxisParent** record (section [2.4.13](#)) specifies if the **axis group** is the primary axis group or the secondary axis group on a **chart**. Often the **axes** of the primary **axis group** are displayed to the left and bottom sides of the plot area, while **axes** of the secondary **axis group** are displayed on the right and top sides of the plot area.
- The **Pos** record (section [2.4.201](#)) specifies the position and size of the outer plot area. The outer plot area is the **bounding rectangle** that includes the **axis** labels, the **axis** titles, and **data table** (section [2.2.3.14](#)) of the **chart**. This record MUST be ignored on a secondary **axis group**.
- The sequences of records that conform to the **IVAXIS** (section 2.1.7.20.1), **DVAXIS** (section 2.1.7.20.1), and **SERIESAXIS** (section 2.1.7.20.1) rules in the collection of records that conform to the **AXES** rule (section 2.1.7.20.1) specify the **axes** of the **axis group**.
- The sequences of records that conform to the **ATTACHEDLABEL** rule (section 2.1.7.20.1) in the sequence of records that conform to the **AXES** rule specify the **axis** titles of the **axis group**. Each **attached label** (section [2.2.3.15](#)) MUST contain an **ObjectLink** record (section [2.4.182](#)) that conforms to the following requirements:
 - The **wLinkObj** field MUST equal to 0x0002, 0x0003, or 0x0007, indicating which **axis** the **axis** title is associated.
 - The **wLinkObj** field MUST specify an **axis** defined in the current **axis group**.
 - The **wLinkObj** field MUST be unique among the other **attached labels** that represent **axis** titles in the same **axis group**.
- The **PlotArea** record (section [2.4.197](#)) and the sequence of records that conforms to the **FRAME** rule (section 2.1.7.20.1) in the sequence of records that conform to the **AXES** rule specify the properties of the inner plot area. The inner plot area is the rectangle bounded by the chart **axes**. The **PlotArea** record (section 2.4.197) MUST NOT exist on a secondary **axis group**.
- The sequences of records that conform to the **CRT** rule (section 2.1.7.20.1) specify the **chart groups** of the **axis group**.

Because there are many different ways to represent data visually, each representation has specific requirements about the layout of the data and the way it is plotted. This results in restrictions on the combinations of **chart group** types that can be plotted on the same **axis group**, and the combinations of **chart group** types that can be plotted in the same **chart**.

A **chart** MUST contain one of the following:

- A single **axis group** that contains a single **chart group** that contains a **Chart3d** record (section [2.4.46](#)).
- One or two **axis groups** that each contain a single bubble **chart group**.
- One or two **axis groups** that each conform to one of the following restrictions on **chart group** type combinations:
 - Zero or one of each of the following **chart group** types: area, column, line, and scatter.
 - Zero or one of each of the following **chart group** types: bar of pie, doughnut, pie, and pie of pie.
 - A single bar **chart group**.
 - A single filled radar **chart group**.
 - A single radar **chart group**.

In addition to the restrictions on the combinations of **chart group** types that can be plotted on the same **axis group** or **chart**, there are additional restrictions on the **axes** of the **axis group** based on the **chart groups** of the axis group.

The following restrictions apply to the **axes** of an **axis group**:

- The **axis group** MUST NOT contain any **axes** if the **axis group** contains a bar of pie, doughnut, pie, or pie of pie **chart group**.
- The **axis group** MUST contain a **category (2)** or date **axis** if the axis group contains an area, bar, column, filled radar, line, radar, or surface **chart group**.
- The **axis group** MUST contain an area, bar, column, filled radar, line, radar, or surface **chart group** if the axis group contains a category (2) or date **axis**.
- The **axis group** MUST contain two value **axes** if and only if all **chart groups** are of type bubble or scatter.
- The **axis group** MUST contain a series **axis** if and only if the **chart group** attached to the **axis group** is one of the following:
 - An area **chart group** with the **fStacked** field of the **Area** record (section [2.4.2](#)) equal to 0.
 - A column **chart group** with the **fStacked** field of the **Bar** record (section [2.4.15](#)) equal to 0 and the **fCluster** field of the **Chart3d** record equal to 0.
 - A line **chart group** with field **fStacked** of the **Line** record (section [2.4.155](#)) equal to 0.
 - A surface **chart group**.
- The **chart group** on the **axis group** MUST contain a **Chart3d** record if the **axis group** contains a series **axis**.

2.2.3.6 Axis

An **axis** is a line that borders the **chart** (section [2.2.3.3](#)) **plot area** and provides a frame of reference for measurement. In addition to the **axis** line and its properties, the **axis** also specifies all parts of the **chart** that are associated with the **axis** line, such as the **axis** labels, **major gridlines**, **minor gridlines**, and the **walls** and **floor** of the **chart**.

An **axis** is specified by a sequence of records that conforms to either the **IVAXIS** (section [2.1.7.20.1](#)), **DVAXIS** (section [2.1.7.20.1](#)), or **SERIESAXIS** (section [2.1.7.20.1](#)) rules specified by the **chart sheet substream** (section [2.1.7.20.1](#)) **ABNF**.

An **axis** has a type as defined by the following table:

Type	Specified By	Description
Category	A sequence of records that conform to the IVAXIS that contains an AxcExt record (section 2.4.9) with field fDateAxis equal to 0.	A category (2) axis displays a set of category (2) labels that are evenly distributed along the axis in a given order. A category (2) axis displays arbitrary text values such as "Qtr1", "Qtr2", and "Qtr3", and cannot display scaled numerical values.
Date	A sequence of records that conform to the IVAXIS rule that contains an AxcExt record with field fDateAxis equal to 1.	A date axis displays scaled date or time values and can display data points (section 2.2.3.10) located at uneven intervals.
Series	A sequence of records that conform to the SERIESAXIS rule.	A series axis displays a set of series (section 2.2.3.9) names that are evenly distributed along

Type	Specified By	Description
		the axis. When this axis is used, the data points of each series are plotted in a 3-dimensional space. The data points of a single series are plotted on a plane identified by the corresponding series name on this axis .
Value	A sequence of records that conform to the DVAXIS rule.	A value axis displays scaled numeric values. The bubble and scatter chart groups (section 2.2.3.7), which can contain two value axes, distinguish the value axes by specifying the axis orientation, either horizontal or vertical.

The following records and rules define the significant parts of an axis:

- The **CatSerRange** (section [2.4.39](#)) and **ValueRange** (section [2.4.341](#)) records specify the scaling properties of the **axis**, the crossing location of the other **axis** in the **axis group** (section [2.2.3.5](#)), and the direction of the **axis**.
- The **AxcExt** record specifies if an **axis** is of type category (2) or date and specifies properties of a date **axis**.
- The **CatLab** record (section [2.4.38](#)) specifies additional properties of the **axis** labels.
- The **IFmtRecord** record (section [2.4.143](#)) in the sequence of records that conform to the **AXS** rule (section 2.1.7.20.1) specifies the **number format** of the **axis** labels.
- The **Tick** record (section [2.4.327](#)) in the sequence of records that conform to the **AXS** rule specifies properties of the **axis** labels, and specifies the **major tick marks** and **minor tick marks** of the **axis**.
- The **FontX** record (section [2.4.123](#)) and the sequence of records that conforms to the **TEXTPROPS** rule (section 2.1.7.20.1), in the collection of records that conform to the **AXS** rule, specify the font properties of the **axis** labels.
- The **AxisLine** (section [2.4.12](#)) and **LineFormat** (section [2.4.156](#)) record pairs and the sequences of records that conform to the **SHAPEPROPS** rule (section 2.1.7.20.1), in the sequence of records that conform to the **AXS** rule, specify the **axis** line, major gridlines and minor gridlines of the **axis**, and the **border** lines of the walls and floor of the **chart**. The omission of the **AxisLine** and **LineFormat** record pair specifying the axis line results in the **axis** line having default line format properties. The omission of other **AxisLine** and **LineFormat** record pairs results in the corresponding **chart** element being omitted from the **chart**.
- The **AreaFormat** record (section [2.4.3](#)) and the collection of records that conform to the **GELFRAME** rule (section 2.1.7.20.1) in the sequence of records that conform to the **AXS** rule specifies the fill format for the walls and floor of the **chart**. If the **wType** field of the **Axis** record (section [2.4.11](#)) in the **axis** equals 0x0000, these records apply to the walls of the **chart**. If the **wType** field of the **Axis** record in the **axis** equals 0x0001, these records apply to the floor of the **chart**. If the **wType** field of the **Axis** record in the axis equals 0x0002, these records MUST NOT exist. If the **chart sheet substream** does not contain a **Chart3d** record (section [2.4.46](#)), these records MUST NOT exist.
- The sequence of records that conforms to the **AXM** rule (section 2.1.7.20.1) specifies the **display units** and the display units label of a value **axis**.

2.2.3.7 Chart Group

A **chart group** is a set of one or more **series** (section [2.2.3.9](#)) that visually represent data in a similar manner and are plotted using the same coordinate system. A **chart group** also includes all parts of the **chart** (section [2.2.3.3](#)) that are associated with the set of **series** and the chart group can specify default properties for the **data points** (section [2.2.3.10](#)) and **data labels** (section [2.2.3.11](#)) associated with the **series**.

Basic **charts** have a single **chart group** because they contain one or more **series** of a single type and all **data points** are plotted using the same coordinates. Complex **charts**, such as combination **charts** that contain multiple **series** of different types or multiple **series** of similar type that are plotted using different sets of **axes** (section [2.2.3.6](#)), contain multiple **chart groups**.

A **chart group** specifies a collection of **series** of a common type that share an **axis group** (section [2.2.3.5](#)) and specifies the **chart** elements that are common to the collection of **series**.

A **chart group** is specified by a sequence of records that conforms to the **CRT** rule (section [2.1.7.20.1](#)) specified by the **chart sheet substream** (section 2.1.7.20.1) **ABNF**.

A **chart group** has a type as defined by the following table:

Type	Specified By	Description
Area	A chart group that contains an Area record (section 2.4.2).	A chart group type in which the data points of a series are plotted in a line and the region between the line and the horizontal axis is filled.
Bar	A chart group that contains a Bar record (section 2.4.15) with field fTranspose equal to 1.	A chart group type in which the data points in a series are represented as horizontal bars.
Bar of pie	A chart group that contains a BopPop record (section 2.4.25) with field pst equal to 0x02.	A chart group type that plots data points as segments in a circle or bar, where the bar displays the details of the data called out from a single segment of the circle.
Bubble	A chart group that contains a Scatter record (section 2.4.243) with field fBubbles equal to 1.	A chart group type that is a variation on a scatter chart group type in which the data points are represented as bubbles. A bubble chart group type compares three variables. The third variable determines the size of the data point .
Column	A chart group that contains a Bar record (section 2.4.15) with field fTranspose equal to 0.	A chart group type in which the data points in a series are represented as vertical bars.
Doughnut	A chart group that contains a Pie record (section 2.4.194) with field pcDonut not equal to 0x0000.	A chart group type in which multiple series are represented as concentric rings and the data points are represented as segments of the ring.
Filled radar	A chart group that contains a RadarArea record (section 2.4.213).	A chart group type that is a variation on a radar group type in which the data points in a series are connected by a line and the area enclosed by the line is filled.
Line	A chart group that contains a Line record (section 2.4.155).	A chart group type in which data points in a series are connected by a line.
Pie	A chart group that contains a Pie record (section 2.4.194) with field pcDonut equal to 0x0000.	A chart group type that plots data points as segments (or slices) of a circle.
Pie of pie	A chart group that contains a BopPop	A chart group type that plots data points as

Type	Specified By	Description
	record (section 2.4.25) with field pst equal to 0x01.	segments (or slices) of two circles, where the secondary circle displays the details of the data called out from a single segment of the primary circle.
Radar	A chart group that contains a RadarArea record (section 2.4.213).	A chart group type in which each data point in a series is plotted along a separate axis that starts at the center of the chart and extends outward.
Scatter	A chart group that contains a Scatter record (section 2.4.243) with field fBubbles equal to 0.	A chart group type that displays quantitative values on both horizontal and vertical axes to represent two variables as a single data point .
Surface	A chart group that contains a Surf record (section 2.4.272).	A chart group type that shows a three dimensional surface that connects a set of data points .

The following records and rules define the significant parts of a chart group:

- The **SeriesList** record (section 2.4.253) specifies the **series** of the **chart**. This record MUST NOT exist in the first **chart group** in the **chart sheet substream**. This record MUST exist when not in the first **chart group** in the **chart sheet substream**.
- The **Chart3d** record (section 2.4.46) specifies that the **plot area**, **axis group** (section 2.2.3.5), and **chart group** are rendered in a 3-D scene, rather than a 2-D scene, and specifies properties of the 3-D scene. If this record exists in the **chart sheet substream**, the **chart sheet substream** MUST have exactly one **chart group**. This record MUST NOT exist in a bar of pie, bubble, doughnut, filled radar, pie of pie, radar, or scatter **chart group**.
- The sequence of records that conforms to the **LD** rule (section 2.1.7.20.1) specifies the **legend** (section 2.2.3.8) on the **chart**. The sequence of records that conforms to the **LD** rule (section 2.1.7.20.1) MUST NOT exist in a **chart group** that is not the first **chart group** in the **chart sheet substream**.
- The sequences of records that conform to the **DROPBAR** rule (section 2.1.7.20.1) specify the **up-down bars** on the **chart group**.
- The **CrtLine** (section 2.4.68) **LineFormat** (section 2.4.156) record pairs and the sequences of records that conform to the **SHAPEPROPS** rule (section 2.1.7.20.1) specify the **drop lines**, **high-low lines**, **series lines**, and **leader lines** for the **chart**.
- The sequences of records that conform to the **DFTTEXT** rule (section 2.1.7.20.1), the **DataLabExtContents** record (section 2.4.76), and the sequence of records that conforms to the **SS** rule (section 2.1.7.20.1) specify the **data label** and **data point** formatting for the **chart group**. Refer to the **data label** overview for details on the **chart group data label**.

2.2.3.8 Legend

A **legend** identifies different groupings of information about the **chart** (section 2.2.3.3). A **legend** consists of a set of **legend entries**. Each legend entry, which consists of a **legend key** and a text label, identifies either the **data points** (section 2.2.3.10) in the **chart**, the **series** (section 2.2.3.9) and **trendlines** in the **chart**, or the bands on a surface **chart group** (section 2.2.3.7).

A **legend** is specified by a sequence of records that conforms to an **LD** rule (section 2.1.7.20.1) in a **chart group** as specified by the **chart sheet substream** (section 2.1.7.20.1) **ABNF**.

A **legend** on a **chart** can contain three types of content:

- A **legend** can contain legend entries for each of the **series** and trendlines in the **chart**:
 - Each legend entry represents a single **series** or trendline.
 - The legend keys contain the same formatting as the corresponding **series** or trendline.
 - The **legend** text labels contain the name of the corresponding **series** or trendline.
 - This type of **legend** is used when the **chart group** type is not surface and one of the following conditions is satisfied:
 - The **chart** has more than one included **series**.
 - The **chart** has a single included **series**, no **data point** formatting exceptions on the included **series**, and either contains a trendline or contains a **ChartFormat** record (section [2.4.48](#)) associated with the included **series** that has the **fVaried** field equal to 0 or ignored.
- A **legend** can contain legend entries for each **data point** in the **chart**:
 - Each legend entry represents a single **data point** on the **chart**.
 - The legend keys contain the same formatting as the corresponding **data point**.
 - The **legend** text labels contain the **category (2)** name or horizontal value of the corresponding **data point**.
 - This type of **legend** is used when the **chart group** type is not surface and the conditions for a **legend** that contains legend entries for each of the **series** and trendlines in the **chart** are not satisfied.
- A **legend** can contain legend entries for each band on a surface **chart group** (which is formatted into different bands based on the value of the surface at any given **data point** in space):
 - Each legend entry represents a single band that represents a range of values on a surface **chart group**.
 - The legend keys contain the same formatting as the corresponding band.
 - The **legend** text labels contain the value range of the corresponding band.
 - This type of **legend** is used when the chart contains a surface **chart group**.

The following records and rules define the significant parts of a **legend**:

- The **Legend** record (section [2.4.152](#)) specifies the layout of the legend and specifies if the **legend** is automatically positioned.
- The **Pos** record (section [2.4.201](#)), **CrtLayout12** record (section [2.4.66](#)), and the sequence of records that conforms to the **CRTMLFRT** rule (section 2.1.7.20.1), specify the position of the **legend**.
- The sequences of records that conform to the **ATTACHEDLABEL** (section 2.1.7.20.1) and **TEXTPROPS** (section 2.1.7.20.1) rules specify the default text formatting for the legend entries. The **Pos** record of the **attached label** (section [2.2.3.15](#)) **MUST** be ignored. The **ObjectLink** record (section [2.4.182](#)) of the attached label **MUST NOT** exist. A **series** can specify formatting exceptions for individual legend entries.
- The sequence of records that conforms to the **FRAME** rule (section 2.1.7.20.1) specifies the fill and **border formatting** properties of the **legend**.

2.2.3.9 Series

A **series** is of a set of related **data points** (section [2.2.3.10](#)) that are plotted in a **chart** (section [2.2.3.3](#)). In addition to specifying the **data points** of the **series** and the formatting properties of the **data points**, a **series** can also specify a series name and properties of the **data label** (section [2.2.3.11](#)) and **legend entries** that are associated with the **series**.

A **series** is defined by a sequence of records that conforms to the **SERIESFORMAT** rule (section [2.1.7.20.1](#)) specified by the **chart sheet substream** (section 2.1.7.20.1) **ABNF** that contains a **SerToCrt** record (section [2.4.256](#)).

A **series** can either be of type included or excluded. Included **series** are **series** that are shown in the **chart**. Excluded **series** are not shown in the **chart**, but exist as **series** in the file. A **series** is an excluded **series** if both of the following conditions are satisfied:

- The **chart group** (section [2.2.3.7](#)) type of the **series** is bar of pie, pie, or pie of pie.
- The **series** is not the first **series** in the **chart sheet substream** to be on the **chart group** and contain in the second sequence of records that conform to the **AI** rule (section 2.1.7.20.1) a **BRAI** record (section [2.4.29](#)) that contains an **ifmt** field that specifies a **formula** (section [2.2.2](#)) that equals to a row or column that is not excluded from the **chart sheet**.

This occurs when the **chart group** is of type bar of pie, pie, or pie of pie, and the **chart sheet** contains multiple **series**, because these **chart group** types will only display the first **series** of data on the **chart**.

All other **series** are included **series**.

The following records and rules define the significant parts of a **series**:

The **Series** record (section [2.4.252](#)) specifies the type and size of the data in the **series**.

- The four sequences of records that conform to the **AI** rule specify **formulas**. The meaning of the **formulas** are specified as follows:
 1. In the first sequence, the value of the **formula** specifies the name of the **series**. The **SeriesText** record (section [2.4.254](#)) specifies a cache of the name of the **series**.
 2. In the second sequence, the value of the **formula** specifies:
 - A set of coordinates along the vertical value **axis** (section [2.2.3.6](#)) if the series is in a bubble or scatter **chart group**.
 - A set of coordinates along the value **axis** if the series is in any other **chart group** type.
 3. In the third sequence, the value of the **formula** specifies:
 - A set of coordinates along a horizontal value **axis** if the **series** is in a bubble or scatter **chart group**.
 - A set of **category (2) axis** labels that are distributed evenly along the category (2) **axis** based on their order in the set or a set of dates along a date **axis** is in any other **chart group** type.
 4. In the fourth sequence of records, the value of the **formula** specifies a set of scalar values used in a bubble **chart group** to define the size of the bubbles.
- The sequence of records that conform to the **SS** rule (section 2.1.7.20.1) specify the **data point** and **data label** properties for a **series** or individual **data points** of the **series**. If formatting is not specified for an individual **data point**, the **data point** inherits the formatting of the series. If formatting is not specified for the **series**, the **series** inherits the formatting of the **chart group**

that contains the **series**. The **yi** field of the **DataFormat** record (section [2.4.74](#)) MUST specify the zero-based index of the **Series** record associated with this **series** in the collection of all **Series** records in the current **chart sheet substream** that contains the **series**. Refer to the **data label** overview for an explanation of the **data label** and the conditions on this collection of records.

- The **SerToCrt** record (section 2.4.256) specifies the **chart group** that contains the current **series**.
- The **LegendException** record (section [2.4.153](#)) specifies a legend entry in the **legend** (section [2.2.3.8](#)) that corresponds to the **series**. If the **LegendException** record (section 2.4.153) specifies that the legend entry has non-default formatting, then the **attached label** (section [2.2.3.15](#)) and the sequence of records that conforms to the **TEXTPROPS** rule (section 2.1.7.20.1) that follow the **LegendException** (section 2.4.153) and **Begin** (section [2.4.17](#)) records specify the custom formatting of the legend entry. If the **fLabel** field of **LegendException** equals 0, the **attached label** MUST NOT exist.

2.2.3.10 Data Point

A **data point** is a value plotted in a **chart** (section [2.2.3.3](#)) and visually displayed as shapes, such as bars, columns and markers, as specified by the **chart group** (section [2.2.3.7](#)) type of the **chart**.

A **data point** consists of a set of three values located on the same index of the second to fourth sequences of records that conform to the **AI** rule (section [2.1.7.20.1](#)) contained in the **series** (section [2.2.3.9](#)) of the **data point**. For example, the set of three values for a **data point** in a bubble **chart group** consists of a coordinate of the **data point** along the vertical value **axis** (section [2.2.3.6](#)), the coordinate of the **data point** along the horizontal value **axis**, and the scalar value that defines the **bubble size** of the **data point**.

2.2.3.11 Data Label

A **data label** is a label on a **chart** (section [2.2.3.3](#)) that is associated with a **data point** (section [2.2.3.10](#)), or associated with a **series** (section [2.2.3.9](#)) on an area or filled radar **chart group** (section [2.2.3.7](#)). A **data label** contains information about the associated **data point**, such as the description of the **data point**, a **legend key**, or custom text.

Inheritance

For any given **data point**, there is an order of inheritance that determines the contents of a **data label** associated with the **data point**:

- **Data labels** can be specified for a **chart group**, specifying the default setting for the **data labels** associated with the **data points** on the **chart group**.
- **Data labels** can be specified for a **series**, specifying the default setting for the **data labels** associated with the **data points** of the **series**. This type of **data label** overrides the **data label** properties specified on the **chart group** for the **data labels** associated with the **data points** in a given **series**.
- **Data labels** can be specified for a **data point**, specifying the settings for a **data label** associated with a particular **data point**. This type of **data label** overrides the **data label** properties specified on the **chart group** and **series** for the **data labels** associated with a given **data point**.

Records

The set of records that specifies a **data label**, and the requirements that exist on these records, differ if the **data label** is specified for a **chart group**, **series**, or **data point**. The set of records that represent a **data label** are as follows:

- For a **chart group**, properties of a data label are specified by the following collections of records that are specified in the **chart group**:
 1. The sequence of records that conforms to the **DFTTEXT** rule (section [2.1.7.20.1](#)).
 2. The **DataLabExtContents** record (section [2.4.76](#)) that is not contained in the sequence of records that conforms to the **LD** rule (section [2.1.7.20.1](#)) or the sequence of records that conforms to the **DFTTEXT** rule.
 3. The **AttachedLabel** record (section [2.4.5](#)) that is contained in the sequence of records that conforms to the **SS** rule (section [2.1.7.20.1](#)).
- For a **series** or **data point**, properties of a data label are specified by the following collections of records that are specified in the **chart**:
 1. The **attached label** (section [2.2.3.15](#)) that corresponds to the **series** or **data point**. The **attached label** that corresponds to a **series** or **data point** appears in the **chart sheet substream** (section [2.1.7.20.1](#)) after the **axis group** (section [2.2.3.5](#)) and is specified by the following properties of the **attached label**:
 1. The **wLinkObj** field of the **ObjectLink** record (section [2.4.182](#)) equals 0x0004.
 2. The **wLinkVar1** field of the **ObjectLink** record equals the index to the corresponding **series**.
 3. The **wLinkVar2** field of the **ObjectLink** record equals the index to the corresponding **data point** or equals 0xFFFF for a corresponding **series**.
 2. The **AttachedLabel** record (section [2.4.5](#)) that corresponds to the **series** or **data point**. The **AttachedLabel** record that corresponds to a **series** or **data point** appears in the sequence of records that conforms to the **SS** rule that has the following properties:
 1. The **yi** field of the **DataFormat** record (section [2.4.74](#)) equals the index to the corresponding **series**.
 2. The **xi** field of the **DataFormat** record equals the index to the corresponding **data point** or equals 0xFFFF for a corresponding **series**.

Overrides

Some properties of the records that specify the contents of a **data label** can overlap and conflict. For the information that overlaps between these records, there is a set of rules that specifies the relationships between these records and specifies the fields that need to be ignored in conflict situations.

In general, properties of the **DataLabExtContents** record (section [2.4.76](#)) of the **data label** override properties of the **Text** record (section [2.4.324](#)) of the **data label**, which overrides the properties of the **AttachedLabel** record of the **data label**. Details of the relationships between individual fields are specified in the records.

The following section provides an explanation of how to interpret the **data label** and when the different records that specify the **data label** are relevant to the **data label**.

On a **data label** associated with a **chart group**:

- When the **chart group** has a data label, the following algorithm determines the **data label** contents. Once the set of records that represents the **data label** has been established, the data label information that overlaps across records is respected on the **DataLabExtContents** record and ignored on the **Text** and **AttachedLabel** records of the **data label**. In this algorithm, **ABNF** rules are used to specify the sequence of records that conform to the rule. In this algorithm,

"DFTTEXT with id" specifies the sequence of records that conforms to the **DFTTEXT** rule that contains a **DefaultText** record (section [2.4.88](#)) with an **id** field equal to the value specified.

```
//Define variables
X equals a DataLabExtContents record
Y equals a DataLabExtContents record
SS equals an AttachedLabel record
SWAP equals a boolean

//Initialize SWAP
SET SWAP equal to FALSE

//Initialize SS
SET SS equal to AttachedLabel record in the sequence of records that conforms to
the SS rule

//Initialize X
IF DFTTEXT with id field equal to 0 exists
  IF DFTTEXT with id field equals to 0 has a DataLabExtContents record
    SET X equal to DataLabExtContents record in DFTTEXT with id field equal to
    0
  ELSE
    IF chart group type equals area or filled radar
      SET field fSerName of X equal to field fShowLabel of Text record in
      DFTTEXT with id field equal to 0
      SET field fCatName of X equal to 0
    ELSE
      SET field fCatName of X equal to field fShowLabel of Text record in
      DFTTEXT with id field equal to 0
      SET field fSerName of X equal to 0
    END IF
    SET field fValue of X equal to field fShowValue of Text record in DFTTEXT
    with id field equal to 0
    SET field fPercent of X equal to field (fShowPercent OR fShowLabelAndPerc)
    of Text record in DFTTEXT with id field equal to 0
    SET field fBubSizes of X equal to field fShowBubbleSizes of Text record in
    DFTTEXT with id field equal to 0
    SET field RgchSet of X equal to NULL
  END IF
ELSE
  SET field fCatName of X equal 1
  SET fields fSerName, fValue, fPercent, fBubSizes of X equal to 0
  SET field RgchSet of X equal to NULL
END IF

//Initialize Y
IF DFTTEXT with id field equal to 1 exists
  IF DFTTEXT with id field equals to 1 has a DataLabExtContents record
    SET Y equal to DataLabExtContents record in DFTTEXT with id field equal to
    1
  ELSE
    IF chart group type equals area or filled radar
      SET field fSerName of Y equal to field (fShowLabel OR
      fShowLabelAndPerc) of Text record in DFTTEXT with id field equal to
      1
      SET field fCatName of Y equal to 0
    ELSE
      SET field fCatName of Y equal to field (fShowLabel OR
      fShowLabelAndPerc) of Text record in DFTTEXT with id field equal to
      1
      SET field fSerName of Y equal to 0
    END IF
    SET field fValue of Y equal to field fShowValue of Text record in DFTTEXT
    with id field equal to 1
    SET field fPercent of Y equal to field (fShowPercent OR fShowLabelAndPerc)
    of Text record in DFTTEXT with id field equal to 1
    SET field fBubSizes of Y equal to field fShowBubbleSizes of Text record in
    DFTTEXT with id field equal to 1
    SET field RgchSet of X equal to NULL
```

```

    END IF
ELSE
    SET field fValue of Y equal to 1
    SET fields fCatName, fSerName, fPercent, fBubSizes of Y equal to 0
    SET field RgchSet of X equal to NULL
END IF

//Modify X, Y, and SS
IF (field fCatName of X equals 1) AND (fields fSerName, fValue, fPercent, AND
fBubSizes of X equal 0)
    IF (field fShowValue of SS equals 1) AND (fields fShowPercent,
fShowLabelAndPerc, fShowLabel, fShowBubbleSizes, AND fShowSeriesName of
SS equal 0)
        IF (field fValue of Y equals 1) AND (fields fSerName, fCatName,
fPercent, OR fBubSizes of Y equal 1)
            SET SWAP equals to TRUE
            SET field fValue of X equal to 1
            SET fields fSerName, fCatName, fPercent, AND fBubSizes of X equal
to 0
            SET field fShowValue of SS equal to field fValue of Y
            SET field fShowPercent of SS equal to field fSPercent of Y
            SET field fShowLabel of SS equal to field fCatName of Y
            SET field fShowBubbleSizes of SS equal to field fBubSizes of Y
            SET field fShowSeriesName of SS equal to field fSerName of Y
        END IF
    ELSE
        IF ((field fShowPercent of SS equals 1) AND (field fShowBubbleSizes of
SS equals 0)) OR ((field fShowPercent of SS equals 0) AND (field
fShowBubbleSizes of SS equals 1)) AND (fields fShowLabelAndPerc,
fShowLabel, fShowValue, AND fShowSeriesName of SS equal 0)
            SET SWAP equals to TRUE
            SET field fValue of X equal to 1
            SET fields fSerName, fCatName, fPercent, AND fBubSizes of X equal
to 0
            SET field fShowValue of SS equal to field fValue of Y
            SET field fShowPercent of SS equal to field fSPercent of Y
            SET field fShowLabel of SS equal to field fCatName of Y
            SET field fShowBubbleSizes of SS equal to field fBubSizes of Y
            SET field fShowSeriesName of SS equal to field fSerName of Y
        ELSE
            IF (field fShowLabel of SS equals 1) AND (fields fShowPercent,
fShowLabelAndPerc, fShowValue, fShowBubbleSizes, AND
fShowSeriesName of SS equal 0)
                IF chart group type equals area or filled radar
                    SET field fSerName of X equal to 1
                    SET fields fCatName, fValue, fPercent, AND fBubSizes equal
to 0
                    SET field fShowValue of SS to 1
                    SET fields fShowPercent, fShowLabelAndPerc, fShowLabel,
fShowBubbleSize, and fShowSeriesName of SS to 0
                END IF
                SET field fValue of Y equals to 1
                SET fields fSerName, fCatName, fPercent, AND fBubSizes of Y
equal to 0
            ELSE
                IF fields fShowLabel, fShowPercent, fShowLabelAndPerc,
fShowValue, fShowBubbleSizes, AND fShowSeriesName of SS
equal 0
                    IF chart group type equals area or filled radar
                        SET fields fShowLabel of SS to 1
                        SET fields fShowPercent, fShowLabelAndPerc, fShowValue,
fShowBubbleSize, and fShowSeriesName of SS to 0
                    END IF
                    SET field fValue of Y equals to 1
                    SET fields fSerName, fCatName, fPercent, AND fBubSizes of Y
equal to 0
                END IF
            END IF
        END IF
    END IF

```

```

        END IF
    END IF
ELSE
    IF (field fValue of Y equals 1) AND (fields fSerName, fCatName, fPercent,
        AND fBubSizes of Y equal 0)
        IF fields fShowLabel, fShowPercent, fShowLabelAndPerc, fShowValue,
            fShowBubbleSizes, AND fShowSeriesName of SS equal 0
            IF (chart group type equals area or filled radar) AND (field
                fSerName of X equals 1) AND (fields fCatName, fValue, fPercent,
                AND fBubSizes of X equal 0)
                SET field fShowSeriesName of SS to 1
                SET fields fShowPercent, fShowLabelAndPerc, fShowValue,
                    fShowBubbleSize, and fShowLabel of SS to 0
            ELSE
                SET field fCatName of X equals to 1
                SET fields fSerName, fValue, fPercent, AND fBubSizes of X equal
                    to 0
            END IF
        ELSE
            IF (field fShowValue of SS equals 1) AND (fields fShowLabel,
                fShowPercent, fShowLabelAndPerc, fShowBubbleSizes, AND
                fShowSeriesName of SS equal 0)
                SET field fCatName of X equals to 1
                SET fields fSerName, fValue, fPercent, AND fBubSizes of X equal
                    to 0
            ELSE
                SET field fShowValue of SS equal to field fValue of X
                SET field fShowPercent of SS equal to field fSPercent of X
                SET field fShowLabel of SS equal to field fCatName of X
                SET field fShowBubbleSizes of SS equal to field fBubSizes of X
                SET field fShowSeriesName of SS equal to field fSerName of X
            END IF
        END IF
    END IF
END IF

//Determine if X or Y is used
IF (field fShowValue of SS equals 1) AND (fields fShowLabel, fShowPercent,
    fShowLabelAndPerc, fShowBubbleSizes, AND fShowSeriesName of SS equal 0)
    IF (SWAP equals FALSE)
        IF DFTTEXT with id field equal to 1 exists
            SET the data label equal to DFTTEXT with id field equal to 1
        ELSE
            SET the data label equal to the default formatting properties
        END IF
        SET the DataLabExtContents record of the data label equal to Y
    ELSE
        IF DFTTEXT with id field equal to 0 exists
            SET the data label equal to DFTTEXT with id field equal to 0
        ELSE
            SET the data label equal to the default formatting properties
        END IF
        SET the DataLabExtContents record of the data label equal to X
    END IF
ELSE
    IF (SWAP equals FALSE)
        IF DFTTEXT with id field equal to 0 exists
            SET the data label equal to DFTTEXT with id field equal to 0
        ELSE
            SET the data label equal to the default formatting properties
        END IF
        SET the DataLabExtContents record of the data label equal to X
    ELSE
        IF DFTTEXT with id field equal to 1 exists
            SET the data label equal to DFTTEXT with id field equal to 1
        ELSE
            SET the data label equal to the default formatting properties
        END IF
        SET the DataLabExtContents record of the data label equal to Y
    END IF
END IF

```

END IF
END IF

On a **data label** associated with a **series** or **data point**:

- The **attached label** specifies an exception on the **data label** and indicates that the current **data label** differs from the **data label** inherited from the **chart group** for a **series**, or from the **chart group** and **series** for a **data point**. The **attached label** of the **data label** contains a **Text** record and can contain a **DataLabExtContents** record.
- On a **data label** associated with a **data point**, when the **attached label** exists and contains a **BRAI** record (section [2.4.29](#)) with field **formula** not equal to 0x0000, the **formula** field specifies the contents of the **data label**.
- On a **data label** associated with a **data point**, when the **attached label** exists and contains a **SeriesText** record (section [2.4.254](#)) and a **BRAI** record with field **formula** equal to 0x0000, the **SeriesText** record specifies the contents of the **data label**.
- When the **attached label** exists and contains a **DataLabExtContents** record, the **data label** information specified by the **DataLabExtContents** record that overlaps across records is respected, and the information contained in the **Text** and **AttachedLabel** records of the **data label** that overlaps is ignored.
- When the **attached label** exists and does not contain a **DataLabExtContents** record, the **data label** specified by the **Text** record that overlaps across records is respected, and the information contained in the **AttachedLabel** record of the **data label** that overlaps is ignored.
- When the **data label** does not specify an **attached label**, the **AttachedLabel** record of the **data label** specifies the content properties of the **data label**.

Restrictions

The following requirements and restrictions exist on different parts of the collections of records that represent the **data label**.

If the **chart group** contains a **data label**:

- The **chart group** SHOULD [<13>](#) contain two sequences of records that conform to the **DFTTEXT** rule that have the same records with the same field values.
- If the **chart group** contains a **DataLabExtContents** record, the **DataLabExtContents** record in the sequences of records that conform to the **DFTTEXT** rule on the chart group and the **DataLabExtContents** record that is not specified in the sequences of records that conform to the **DFTTEXT** rule on the chart group SHOULD [<14>](#) contain the same field values.
- If the **chart group** contains a sequence of records that conforms to the **DFTTEXT** rule the following restrictions apply:
 - The **fShowValue** field of the **AttachedLabel** record SHOULD [<15>](#) equal the **fShowValue** field of the **Text** record in the sequence of records that conforms to the **DFTTEXT** rule.
 - The **fShowPercent** field of the **AttachedLabel** record SHOULD [<16>](#) equal the **fShowPercent** field of the **Text** record in the sequence of records that conforms to the **DFTTEXT** rule.
 - The **fShowLabelAndPerc** field of the **AttachedLabel** record SHOULD [<17>](#) equal the **fShowLabelAndPerc** field of the **Text** record in the sequence of records that conforms to the **DFTTEXT** rule.

2.2.3.12 Trendline

A **trendline** is a straight or curved line that graphically represents the general trend of the **data points** (section [2.2.3.10](#)) of a **series** (section [2.2.3.9](#)). In addition to specifying the data and formatting properties of the line, the **trendline** name and the **trendline** label can also be specified in the **trendline**.

A trendline is defined by a sequence of records that conforms to the **SERIESFORMAT** rule (section [2.1.7.20.1](#)) specified by the **chart sheet substream** (section 2.1.7.20.1) **ABNF** that contains a **SerAuxTrend** record (section [2.4.250](#)).

The following records and rules define the significant parts of a **trendline**:

- The **SeriesText** record (section [2.4.254](#)) in the first sequence of records that conforms to the **AI rule** (section 2.1.7.20.1) specifies a custom **trendline** name to display in the **legend** (section [2.2.3.8](#)).
- The sequence of records that conforms to the **SS** rule (section 2.1.7.20.1) specifies the formatting properties of the **trendline**. The **yi** field of the **DataFormat** record (section [2.4.74](#)) MUST specify the zero-based index of the **Series** record (section [2.4.252](#)) associated with this **trendline** in the collection of all **Series** records in the current **chart sheet substream**. Each **trendline** MUST contain zero or one sequences of records that conform to the **SS** rule.
- The **SerParent** record (section [2.4.255](#)) specifies the **series** associated with the **trendline**.
- The **SerAuxTrend** record specifies properties of the **trendline**, such as the **trendline** type and the number of periods to **forecast** forward and backward, and specifies properties of the content of the **trendline** label.
- The **LegendException** record (section [2.4.153](#)) specifies the formatting of the **legend entry** in the **legend** (section 2.2.3.8) that corresponds to the **trendline**. This record is specified if the legend entry has been deleted or does not use the default formatting of the **legend**. When the legend entry has non-default formatting, the **attached label** (section [2.2.3.15](#)) that follows the **LegendException** record and **Begin** records (section [2.4.17](#)) specifies the custom formatting of the legend entry.

The following restrictions apply to a **trendline**:

- All fields except the **cValx** and **cValy** fields in the **Series** record (section 2.4.252) MUST be ignored. The **cValy** and **cValx** fields in the **Series** records MUST be greater than 0.
- The **BRAI** records (section [2.4.29](#)) in the sequence of records that conforms to the **AI rule** (section 2.1.7.20.1) MUST be ignored and the **ifmt** field of the **BRAI** records MUST equal 0x0000.

2.2.3.13 Error Bar

An **error bar** is a set of lines displayed on a **chart** (section [2.2.3.3](#)) that indicates a range of uncertainty in the measurement of each **data points** (section [2.2.3.10](#)) in a **series** (section [2.2.3.9](#)).

An **error bar** is specified by a sequence of records that conforms to the **SERIESFORMAT** rule (section [2.1.7.20.1](#)) specified by the **chart sheet substream** (section 2.1.7.20.1) **ABNF** that contains a **SerAuxErrBar** record (section [2.4.249](#)).

The following records and rules define the significant parts of an **error bar**:

- The sequence of records that conforms to the **SS** rule (section 2.1.7.20.1) specifies the formatting properties of the **error bar**. The **yi** field of the **DataFormat** record (section [2.4.74](#)) MUST specify the zero-based index of the **Series** record (section [2.4.252](#)) associated with this **error bar** in the collection of all **Series** record in the current **chart sheet substream**. Each **error bar** MUST contain zero or one sequences of records that conform to the **SS** rule.

- The **SerParent** record (section [2.4.255](#)) specifies the **series** associated with the **error bar**.
- The **SerAuxErrBar** record specifies properties of the **error bar**, including the direction and type of the **error bar**.

The following restrictions apply to **error bars**:

- All fields except the **cValx** and **cValy** fields in the **Series** record MUST be ignored.
- The **cValx** field MUST equal the **cValx** field of the **Series** record in the associated **series** specified by the **SerParent** record.
- If the **ebsrc** field of the **SerAuxErrBar** record equals 0x04 and the **sertm** field of the **SerAuxErrBar** equals 0x01 or 0x02, the **cValx** field MUST equal the number of values represented by the **formula** field of the second **BRAI** record (section [2.4.29](#)) in the sequence of records that conforms to the **AI** rule (section 2.1.7.20.1).
- If the **ebsrc** field of the **SerAuxErrBar** record equals 0x04 and the **sertm** field of the **SerAuxErrBar** equals 0x03 or 0x04, the **cValy** field MUST equal the number of values represented by the **formula** field of the second **BRAI** record in the sequence of records that conforms to the **AI** rule.
- If the **ebsrc** field of the **SerAuxErrBar** record does not equal 0x04, the **cValy** field MUST equal the **cValy** field of the **Series** record in the associated **series** specified by the **SerParent** record.
- The **BRAI** records in the first, third, and fourth sequences of records that conform to the **AI** rule MUST be ignored and the **ifmt** field of the **BRAI** records MUST equal 0x0000.
- If the **ebsrc** field of the **SerAuxErrBar** record equals 0x04, the **ifmt** field of the **BRAI** records contained in the second collection of records that conform to the **AI** rule specifies a **Formula** (section [2.4.127](#)) that specifies custom values of the **error bar**.
- If the **ebsrc** field of the **SerAuxErrBar** record equals 0x04, the **BRAI** records in the second sequence of records that conforms to the **AI** rule MUST be ignored and the **ifmt** field of the **BRAI** records MUST equal 0x0000.
- The **LegendException** record (section [2.4.153](#)) in the **chart sheet substream** MUST NOT exist.

2.2.3.14 Data Table

A **data table (2)** is a table on a **chart** (section [2.2.3.3](#)) that contains a row for each **series** (section [2.2.3.9](#)) and lists the values of each **data point** (section [2.2.3.10](#)) on the **chart**.

A data table (2) is specified by a sequence of records that conforms to a **DAT** rule (section [2.1.7.20.1](#)) as specified by the **chart sheet substream** (section 2.1.7.20.1) **ABNF**.

The following records and rules define the significant parts of a data table (2):

- The **Dat** record (section [2.4.73](#)) specifies if the data table (2) shows **legend keys** next to the name of the **series** and specifies which data table (2) borders are displayed.
- The sequences of records that conform to the **ATTACHEDLABEL** (section 2.1.7.20.1) and **TEXTPROPS** (section 2.1.7.20.1) rules in the sequence of records that conforms to the **LD** rule (section 2.1.7.20.1) specify the text formatting for the data table (2). The **Pos** record (section [2.4.201](#)) of the **attached label** (section [2.2.3.15](#)) MUST be ignored. The **ObjectLink** record (section [2.4.182](#)) of the **attached label** MUST NOT exist.
- The sequence of records that conforms to the **FRAME** rule (section 2.1.7.20.1) in the sequence of records that conforms to the **LD** rule specifies the formatting properties of the data table (2).

The following restrictions apply to the collection of records that represents a data table (2):

- The **fWasDataTable** field of the **Legend** record (section [2.4.152](#)) in the sequence of records that conforms to the **LD** rule MUST equal 1.
- The **Pos** record in the sequence of records that conforms to the **LD** rule MUST be ignored. A data table (2) is automatically positioned.
- The **CrtLayout12** record (section [2.4.66](#)) and the sequence of records that conforms to the **CRTMLFRT** rule (section 2.1.7.20.1), in the sequence of records that conforms to the **LD** rule, MUST NOT exist in a data table (2).

A data table (2) is not displayed on a **chart** if the **chart** contains a bar of pie, bubble, doughnut, filled radar, pie, pie of pie, radar, or scatter **chart group** (section [2.2.3.7](#)).

2.2.3.15 Attached Label

An **attached label** is a generic text element that is used on a **chart** (section [2.2.3.3](#)). An **attached label** can specify properties of an **axis** (section [2.2.3.6](#)) title, **chart** title, **data label** (section [2.2.3.11](#)), **data table** (section [2.2.3.14](#)), **display units** label, **legend** (section [2.2.3.8](#)), **legend entry**, **trendline** (section [2.2.3.12](#)) label, or the default text properties of the entire **chart**.

The location of the **attached label** in the **chart sheet substream** (section [2.1.7.20.1](#)) **ABNF** and the properties of the **ObjectLink** record (section [2.4.182](#)) of the **attached label** specify the **chart** element to which the **attached label** applies. Refer to the **conceptual overviews** (section [2.2.3](#)) for explanation of the meaning of the **attached label** in each context that it is used.

An **attached label** is specified by a collection of records that conforms to an **ATTACHEDLABEL** rule (section 2.1.7.20.1) as specified by the **chart sheet substream** (section 2.1.7.20.1) **ABNF**.

- The **Text** record (section [2.4.324](#)) and the collection of records that conforms to the **TEXTPROPS** rule (section 2.1.7.20.1) specify properties of the text in the **attached label**. These properties include text options such as text rotation and reading order. On **attached labels** that represent **data labels**, the **Text** record also specifies content and layout properties of the **data labels**.
- The **Pos** (section [2.4.201](#)) and **CrtLayout12** (section [2.4.66](#)) records specify the position of the **attached label** on the **chart**. The **Pos** record MUST be ignored if the **attached label** represents the **data labels** on a **series** (section [2.2.3.9](#)) or **chart group** (section [2.2.3.7](#)), a **data table**, the default text of the **chart**, or a **legend key**.
- The **FontX** (section [2.4.123](#)) and **AIRuns** (section [2.4.1](#)) records specify the font and rich text formatting properties of the **attached label**.
- The collection of records that conforms to the **AI** rule (section 2.1.7.20.1) specifies custom text of the **attached label**.
- The collection of records that conforms to the **FRAME** rule (section 2.1.7.20.1) specifies the fill and border properties of the **attached label**.
- The **ObjectLink** record specifies the **chart** element the **attached label** applies to.
- The **DataLabExtContents** record (section [2.4.76](#)) specifies additional **data label** properties on **attached labels** that represent a **data label**. Refer to the **data label** overview for the conditions when this record can be written. This record MUST NOT exist unless the **attached label** specifies properties of a **data label**. An **attached label** specifies properties of a **data label** if the **wLinkObj** field of the **ObjectLink** record is equal to 0x0004 or the attached label is in the collection of records that conforms to the **DFTTEXT** rule (section 2.1.7.20.1) in a **chart group**.
- The collection of records that conforms to the **CRTMLFRT** rule (section 2.1.7.20.1) specifies **future records** (section [2.1.6](#)) for the **attached label**.

2.2.3.16 SPRC

A **SPRC** is a unit of measurement that is 1/4000th of the height or width of the **chart** (section [2.2.3.3](#)). If the field is being used to specify a width or horizontal distance, the **SPRC** is 1/4000th of the width of the **chart**. If the field is being used to specify a height or vertical distance, the **SPRC** is 1/4000th of the height of the **chart**.

2.2.3.17 Chart Area

For non-embedded **charts**, the size of the area is specified by the **Chart** record (section [2.4.45](#)) in points. For embedded **charts**, the **chart** is treated as a drawing and its size is calculated from the **OfficeArtClientAnchorSheet** record (section [2.5.193](#)) that is contained in the **MsoDrawing** (section [2.4.170](#)) preceding the **chart** stream. The **chart area** calculation is as follows:

1. Get **chart area width in pixels**

chart area width in pixels = (dx field of **Chart** record - 8) * DPI of the display device / 72 for non-embedded **charts**.

chart area width in pixels is calculated from individual cell widths/heights that anchor the **chart** as indicated by **OfficeArtClientAnchorSheet** (section 2.5.193) for embedded charts.

If the **frt** field of the **Frame** record (section [2.4.128](#)) following the **Chart** record (section 2.4.45) is 0x0004 and the **chart** is not embedded, add the shadow size:

chart area width in pixels -= 2 * line width of the display device in pixels

2. Get **chart area height in pixels**

chart area height in pixels = (dy field of **Chart** record - 8) * DPI of the display device / 72 for non-embedded **charts**.

chart area height in pixels is calculated from individual cell widths/heights that anchor the **chart** as indicated by **OfficeArtClientAnchorSheet** (section 2.5.193) for embedded charts.

If the **frt** field of the **Frame** record (section 2.4.128) following the **Chart** record (section 2.4.45) is 0x0004 and the **chart** is not embedded, add the shadow size:

chart area height in pixels -= 2 * line height of the display device in pixels

2.2.4 Metadata

Metadata is additional data associated with a particular **cell** or its content. **Metadata** is recorded in **BIFF8** for future extensibility purpose only.

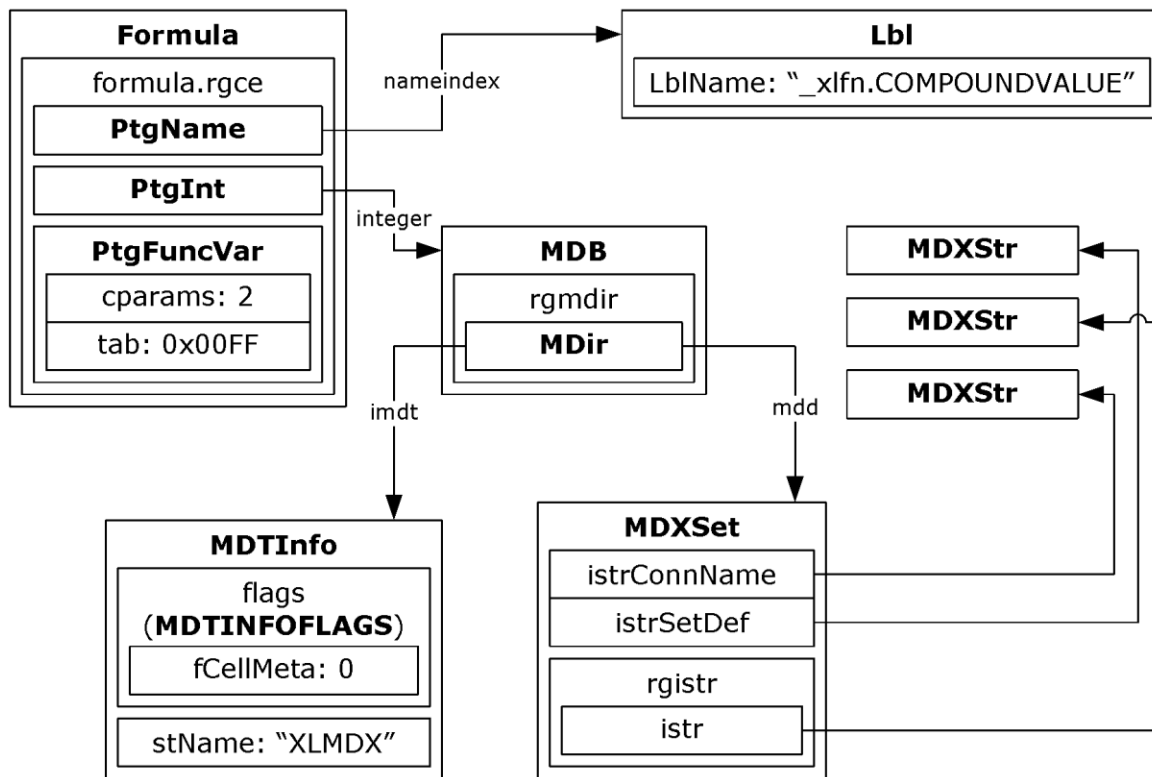

Figure 2: Metadata

The following sections define terms used in this diagram.

2.2.4.1 Metadata Types

The architecture of the metadata allows for multiple types of metadata.

Each type of metadata has an associated collection of metadata records, a unique name, and a set of predefined properties. Those properties describe whether the metadata remains associated with the **cell** or its content during runtime operations (for example, insert, shift, copy/paste, merge, or unmerge operations), as well as whether the metadata is **cell metadata** (section 2.2.4.2) or **value metadata** (section 2.2.4.3).

A metadata type is represented by an **MDTInfo** record (section 2.4.162).

2.2.4.2 Cell Metadata

Cell metadata is metadata associated with a **cell** itself. **Cell metadata** is not represented in **BIFF8** format.

2.2.4.3 Value Metadata

Value metadata is metadata associated with the value of a particular **cell**. **Value metadata** is associated with a cell through a **formula** (section 2.2.2) containing a single special function, `_xlfn.COMPOUNDVALUE`, whose single mandatory argument references a **metadata block** record (section 2.2.4.4) <18>.

The only **value metadata** type represented in **BIFF8** is **MDX metadata** (section 2.2.4.5).

2.2.4.4 Metadata Block

Cells are associated with actual metadata values using a metadata mapping table known as a **metadata block**. A **metadata block** contains a collection of indexes to metadata records, along with the corresponding **metadata types** (section [2.2.4.1](#)).

A **metadata block** is represented by an **MDB record** (section [2.4.161](#)).

2.2.4.5 MDX Metadata

The only type of metadata used is **MDX** metadata.

The **MDTInfo** record (section [2.4.162](#)) that specifies the **metadata type** (section [2.2.4.1](#)) for MDX metadata MUST have the following values:

Field	Value
fGhostRow	0
fGhostCol	0
fEdit	0
fDelete	0
fCopy	1
fPasteAll	1
fPasteFormulas	0
fPasteValues	1
fPasteFormats	0
fPasteComments	0
fPasteDataValidation	0
fPasteBorders	0
fPasteColWidths	0
fPasteNumberFormats	0
fMerge	1
fSplitFirst	1
fSplitAll	0
fRowColShift	1
fClearAll	0
fClearFormats	1
fClearContents	0
fClearComments	1

Field	Value
fAssign	1
fCoerce	1
fAdjust	0
fCellMeta	0
stName	"XLMDX"

An MDX metadata record references the connection name and the **cube function** used or referenced in a **cell**.

There are four types of MDX metadata records: **MDX tuple metadata** (section [2.2.4.5.1](#)), **MDX set metadata** (section [2.2.4.5.2](#)), **MDX member property metadata** (section [2.2.4.5.3](#)), and **MDX KPI metadata** (section [2.2.4.5.4](#)).

2.2.4.5.1 MDX Tuple Metadata

An **MDX tuple** is the intersection between two or more **members (2)** from different **dimensions (1)**.

MDX tuple metadata is used by **cube functions** returning a member (2) or a value.

MDX tuple metadata is represented by an **MDXTuple** record (section [2.4.167](#)).

2.2.4.5.2 MDX Set Metadata

An **MDX set** is an ordered collection of **members (2)** within the same **dimension (1)**.

MDX set metadata is used by **cube functions** returning a set or the number of items in a set.

MDX set metadata is represented by an **MDXSet** record (section [2.4.165](#)).

2.2.4.5.3 MDX Member Property Metadata

An **MDX member property** represents the property value of a **member (2)**.

MDX member property metadata references a member (2) name and a property name.

MDX member property metadata is represented by an **MDXProp** record (section [2.4.164](#)).

2.2.4.5.4 MDX KPI Metadata

An **MDX key performance indicator (KPI)** represents the KPI property value of a KPI **member (2)**.

MDX KPI metadata references a KPI name, a KPI property, and a member (2) name.

MDX KPI metadata is represented by an **MDXKPI** record (section [2.4.163](#)).

2.2.5 PivotTables

A PivotTable is a mechanism for summarizing **source data** (section [2.2.5.3.2](#)) to get an overview of the distribution of that data. In a PivotTable, applicable columns of the **source data** become fields that can be used to summarize data.

When the **source data** of the **PivotTable** is **OLAP source data**, **OLAP hierarchies** and some other OLAP entities become fields in the PivotTable.

A PivotTable has two major parts, a **PivotCache** (section [2.2.5.3](#)) and a **PivotTable view** (section [2.2.5.4](#)). These parts are described in the following sections. There can be multiple **PivotTable views** based on a single non-**OLAP PivotCache** (section [2.2.5.3.4](#)). An **OLAP PivotCache** MUST have exactly one **associated PivotTable view** (section [2.2.5.3.3](#)).

The values produced by a PivotTable are placed in cells of a **sheet (2)** and these cells make up a PivotTable report.

The PivotTable structures are not needed to obtain values from a **PivotTable** report because those values are available in the sheet (2) cells. The structures are needed for the following purposes:

- To show extra information related to a PivotTable report in an application, such as sort and filter information.
- To recalculate a **PivotTable view**, to incorporate changes such as sorting and filtering made to it, and to update the corresponding **PivotTable** report accordingly.
- To refresh a **PivotCache**, to incorporate changes made to the **source data**, and then recalculate any **PivotTable views** associated with the **PivotCache** and to update the corresponding **PivotTable** reports accordingly.

2.2.5.1 PivotTable Records

For general information about records see section [2.1. PivotTable](#) (section [2.2.5](#)) uses records from the **Worksheet Substream** (section [2.1.7.20.5](#)), the **Globals Substream** (section [2.1.7.20.3](#)), and the **streams** in the **Pivot Cache Storage (_SX_DB_CUR)** (section [2.1.7.12](#)).

Concepts specified for **PivotTables** can have multiple sequences of records specifying them. The sequences can be in different streams or substreams. In these cases additional information is specified for the concept in the **PIVOTFRT9** rule (section [2.1.7.20.5](#)) or by **SXAddI** records (section [2.4.273.2](#)). See the individual records, the **QsiSXTag** record (section [2.4.211](#)) and section [2.2.5.1.1](#) for more information about how the additional information is connected to the concept.

2.2.5.1.1 Usage of SXAddI Records

The **SXAddI** records (section [2.4.273.2](#)) is a record used for storing additional **PivotTable view** (section [2.2.5.4](#)), **PivotCache** (section [2.2.5.3](#)) or **query table** information of a variety of types.

SXAddI records have an **hdr** field of type **SXAddIHdr** (section [2.5.253](#)) that specifies the current **class** (section [2.2.5.1.1.1](#)) and the full type of record, see section [2.2.5.1.1.1](#) for details. The full record type specifies the meaning of the **data** field of the **SXAddI** record.

2.2.5.1.1.1 Class

All **SXAddI** records (section [2.4.273.2](#)) are grouped into classes. Each **SXAddI** record has a current class. An **SXAddI** record can be in other classes as well. The different classes and their specifications follow.

Unless the value of the **hdr.sxc** field of **SXAddI** is 0x09 and the value of the **hdr.sxd** field of **SXAddI** is 0xFF, the **hdr.sxc** field of the **SXAddI** record specifies the current class and MUST be a value from the following table:

Name	Value	Current Class
SXCVIEW	0x00	SxcView class (section 2.2.5.1.1.1.1)
SXCFIELD	0x01	SxcField class (section 2.2.5.1.1.1.2)

Name	Value	Current Class
SXCHIERARCHY	0x02	SxcHierarchy class (section 2.2.5.1.1.1.3)
SXCCACHE	0x03	SxcCache class (section 2.2.5.1.1.1.4)
SXCCACHEFIELD	0x04	SxcCacheField class (section 2.2.5.1.1.1.5)
SXCQSI	0x05	SxcQsi class (section 2.2.5.1.1.1.6)
SXCQUERY	0x06	SxcQuery class (section 2.2.5.1.1.1.7)
SXCGRPLEVEL	0x07	SxcGrpLevel class (section 2.2.5.1.1.1.8)
SXCGRP	0x08	SxcGroup class (section 2.2.5.1.1.1.9)
SXCCACHEITEM	0x09	SxcCacheItem class (section 2.2.5.1.1.1.10)
SXCSXRULE	0x0C	SxcSXRule class (section 2.2.5.1.1.1.11)
SXCSXFILT	0x0D	SxcSXFilt class (section 2.2.5.1.1.1.12)
SXCSXDH	0x10	SxcSXDH class (section 2.2.5.1.1.1.13)
SXCAUTOSORT	0x12	SxcAutoSort class (section 2.2.5.1.1.1.14)
SXCSXMGS	0x13	SxcSXMgs class (section 2.2.5.1.1.1.15)
SXCSXMG	0x14	SxcSXMg class (section 2.2.5.1.1.1.16)
SXCFIELD12	0x17	SxcField12 class (section 2.2.5.1.1.1.17)
SXCSXCONDFMTS	0x1A	SxcSXCondFmts class (section 2.2.5.1.1.1.18)
SXCSXCONDFMT	0x1B	SxcSXCondFmt class (section 2.2.5.1.1.1.19)
SXCSXFILTERS12	0x1C	SxcSXFilters12 class (section 2.2.5.1.1.1.20)
SXCSXFILTER12	0x1D	SxcSXFilter12 class (section 2.2.5.1.1.1.21)

The current **class** and the **hdr.sxd** field of **SXAddl** specify the full type of the record, see the individual **classes** for details.

If the value of the **hdr.sxc** field of **SXAddl** is 0x09 and the value of the **hdr.sxd** field of **SXAddl** is 0xFF, then the current **class** is specified by **SxcCacheField** class and the full record type is **SXAddl_SXCCacheItem_SXDEnd** (section [2.4.273.20](#)).

Classes can be nested inside other **classes** in a hierarchical manner as specified by the **Globals Substream** (section [2.1.7.20.3](#)) **Augmented Backus-Naur Form (ABNF)**, **Worksheet Substream** (section [2.1.7.20.5](#)) **ABNF**, and **Common Productions** (section [2.1.7.20.6](#)) **ABNF**. Properties from the outer **classes** apply to the inner **classes** unless otherwise specified. Records in **classes** nested inside other **classes**, are **members (1)** of both the inner and outer **classes**, but their current **class** is given by the value of their **hdr.sxc** field. For example, **SXAddl_SXCHierarchy_SXDProperty** (section [2.4.273.57](#)) is a member (1) of the **SxcView** class and the **SxcHierarchy** class and its current **class** is the **SxcHierarchy** class.

2.2.5.1.1.1.1 SxcView Class

The **SxcView** class specifies additional information for a **PivotTable view** (section [2.2.5.4](#)).

The **SxcView** class is specified by the sequence of records specified by the **PIVOTADDL** rule (section [2.1.7.20.5](#)).

The **PivotTable view** that the **SxcView** class specifies information for is specified by the **stName** field of the **SXAddl_SXCView_SXDId** record (section [2.4.273.105](#)).

If the **hdr.sxc** field of an **SXAddl** record (section [2.4.273.2](#)) equals **SXCVIEW** (0x00), then the **hdr.sxd** field of the **SXAddl** record MUST be a value from the following table which specifies the full record type:

Name	Value	Full record type
SXDID	0x00	SXAddl_SXCView_SXDId
SXDVERUPDINV	0x01	SXAddl_SXCView_SXDVerUpdInv (section 2.4.273.110)
SXDVER10INFO	0x02	SXAddl_SXCView_SXDVer10Info (section 2.4.273.108)
SXDCALCMEMBER	0x03	SXAddl_SXCView_SXDCalcMember (section 2.4.273.100)
SXDCALCMEMSTRING	0x0A	SXAddl_SXCView_SXDCalcMemString (section 2.4.273.101)
SXDVER12INFO	0x19	SXAddl_SXCView_SXDVer12Info (section 2.4.273.109)
SXDTABLESTYLECLIENT	0x1E	SXAddl_SXCView_SXDTableStyleClient (section 2.4.273.107)
SXDCOMPACTRWHDR	0x21	SXAddl_SXCView_SXDCompactRwHdr (section 2.4.273.103)
SXDCOMPACTCOLHDR	0x22	SXAddl_SXCView_SXDCompactColHdr (section 2.4.273.102)
SXDSXPIIVMB	0x26	SXAddl_SXCView_SXDSXPIIvmb (section 2.4.273.106)
SXDEND	0xFF	SXAddl_SXCView_SXDEnd (section 2.4.273.104)

2.2.5.1.1.1.2 SxcField Class

The **SxcField** class specifies additional information for a **pivot field** (section [2.2.5.4.3](#)).

The **SxcField** class is specified by the sequence of records specified by the **SXADDLFIELD** rule (section [2.1.7.20.5](#)).

The **pivot field** that the **SxcField** class specifies information for is specified by the **stName** field of the **SXAddl_SXCField_SXDId** record (section [2.4.273.26](#)).

If the **hdr.sxc** field of an **SXAddl** record (section [2.4.273.2](#)) equals SXCFIELD (0x01), then the **hdr.sxd** field of the **SXAddl** record MUST be a value from the following table which specifies the full record type:

Name	Value	Full record type
SXDID	0x00	SXAddl_SXCField_SXDId
SXDVER10INFO	0x02	SXAddl_SXCField_SXDVer10Info (section 2.4.273.27)
SXDEND	0xFF	SXAddl_SXCField_SXDEnd (section 2.4.273.25)

2.2.5.1.1.1.3 SxcHierarchy Class

The **SxcHierarchy** class specifies additional information for a **pivot hierarchy** (section [2.2.5.4.5](#)).

The **SxcHierarchy** class is specified by the sequence of records specified by the **SXADDLHIERARCHY** rule (section [2.1.7.20.5](#)).

The **pivot hierarchy** (section 2.2.5.4.5) that the **SxcHierarchy** class specifies information for is specified by the **stHierUnq** field of the **SXAddl_SXCHierarchy_SXDId** record (section [2.4.273.47](#)).

If the **hdr.sxc** field of an **SXAddl** record (section [2.4.273.2](#)) equals SXCHIERARCHY (0x02), then the **hdr.sxd** field of the **SXAddl** record MUST be a value from the following table which specifies the full record type:

Name	Value	Full record type
SXDID	0x00	SXAddl_SXCHierarchy_SXDId

Name	Value	Full record type
SXDVERUPDINV	0x01	SXAddl_SXCHierarchy_SXDVerUpdInv (section 2.4.273.60)
SXDPROPERTY	0x05	SXAddl_SXCHierarchy_SXDProperty (section 2.4.273.57)
SXDFILTERMEMBER	0x09	SXAddl_SXCHierarchy_SXDFilterMember (section 2.4.273.44)
SXDSXSETPARENTUNIQUE	0x1D	SXAddl_SXCHierarchy_SXDSXSetParentUnique (section 2.4.273.58)
SXDUSERCAPTION	0x1F	SXAddl_SXCHierarchy_SXDUserCaption (section 2.4.273.59)
SXDICONSET	0x20	SXAddl_SXCHierarchy_SXDId record (section 2.4.273.47)
SXDMEASUREGRP	0x24	SXAddl_SXCHierarchy_SXDMeasureGrp (section 2.4.273.55)
SXDDISPLAYFOLDER	0x25	SXAddl_SXCHierarchy_SXDDisplayFolder (section 2.4.273.42)
SXDPARENTKPI	0x26	SXAddl_SXCHierarchy_SXDParentKPI (section 2.4.273.56)
SXDKPIVALUE	0x27	SXAddl_SXCHierarchy_SXDKPIValue (section 2.4.273.53)
SXDKPIGOAL	0x28	SXAddl_SXCHierarchy_SXDKPIGoal (section 2.4.273.49)
SXDKPISTATUS	0x29	SXAddl_SXCHierarchy_SXDKPIStatus (section 2.4.273.50)
SXDKPITREND	0x2A	SXAddl_SXCHierarchy_SXDKPITrend (section 2.4.273.52)
SXDKPIWEIGHT	0x2B	SXAddl_SXCHierarchy_SXDKPIWeight (section 2.4.273.54)
SXDKPITIME	0x2C	SXAddl_SXCHierarchy_sxDKPITime (section 2.4.273.51)
SXDFILTERMEMBER12	0x3F	SXAddl_SXCHierarchy_sxDFilterMember12 (section 2.4.273.45)
SXDINFO12	0x41	SXAddl_SXCHierarchy_SXDInfo12 (section 2.4.273.48)
SXDEND	0xFF	SXAddl_SXCHierarchy_SXDEnd (section 2.4.273.43)

2.2.5.1.1.1.4 SxcCache Class

The **SxcCache** class specifies additional information for a **PivotCache** (section [2.2.5.3](#)).

The **SxcCache** class is specified by the sequence of records specified by the **SXADDLCACHE** rule (section [2.1.7.20.5](#)).

The **PivotCache** that the **SxcCache** class specifies information for is specified by the **idCache** field of the **SXAddl_SXCCache_SXDId** record (section [2.4.273.6](#)).

If the **hdr.sxc** field of an **SXAddl** record (section [2.4.273.2](#)) equals **SXCCACHE** (0x03), then the **hdr.sxd** field of the **SXAddl** record MUST be a value from the following table which specifies the full record type:

Name	Value	Full record type
SXDID	0x00	SXAddl_SXCCache_SXDId
SXDVERUPDINV	0x01	SXAddl_SXCCache_SXDVerUpdInv (section 2.4.273.11)
SXDVER10INFO	0x02	SXAddl_SXCCache_SXDVer10Info (section 2.4.273.9)

Name	Value	Full record type
SXDVERSMACRO	0x18	SXAddl_SXCCache_SXDVerSXMacro (section 2.4.273.10)
SXDINREFRESHREAL	0x34	SXAddl_SXCCache_SXDInvRefreshReal (section 2.4.273.8)
SXDINFO12	0x41	SXAddl_SXCCache_SXDInfo12 (section 2.4.273.7)
SXDEND	0xFF	SXAddl_SXCCache_SXDEnd (section 2.4.273.5)

2.2.5.1.1.1.5 SxcCacheField Class

The **SxcCacheField** class specifies additional information for a **cache field** (section [2.2.5.3.5](#)).

The **SxcCacheField** class is specified by the sequence of records specified by the **SXADDLCACHEFIELD** rule (section [2.1.7.20.5](#)).

The **cache field** that the **SxcCacheField** class specifies information for is specified by the **stSourceName** field of the **SXAddl_SXCCacheField_SXDId** record (section [2.4.273.14](#)).

If the **hdr.sxc** field of an **SXAddl** record (section [2.4.273.2](#)) equals SXCCACHEFIELD (0x04), then the **hdr.sxd** field of the **SXAddl** record MUST be a value from the following table which specifies the full record type:

Name	Value	Full record type
SXDID	0x00	SXAddl_SXCCacheField_SXDId
SXDPROPERTY	0x05	SXAddl_SXCCacheField_SXDProperty (section 2.4.273.17)
SXDSXRMITMCOUNT	0x2D	SXAddl_SXCCacheField_SXDSxrmitmCount (section 2.4.273.19)
SXDCAPTION	0x2F	SXAddl_SXCCacheField_SXDCaption (section 2.4.273.12)
SXDIFDBMEMPROPMAP	0x30	SXAddl_SXCCacheField_SXDIfdbMempropMap (section 2.4.273.15)
SXDIFDBMPMAPCOUNT	0x31	SXAddl_SXCCacheField_SXDIfdbMpMapCount (section 2.4.273.16)
SXDPROPNAME	0x40	SXAddl_SXCCacheField_SXDPropName (section 2.4.273.18)
SXDEND	0xFF	SXAddl_SXCCacheField_SXDEnd (section 2.4.273.13)

Additionally, **SXAddl_SXCCacheItem_SXDEnd** has a current class of **SxcCacheField** class, as specified in section [2.2.5.1.1.1](#).

2.2.5.1.1.1.6 SxcQsi Class

The **SxcQsi** class specifies additional information for a **query table**.

The **SxcQsi** class is specified by the sequence of records specified by the **SXADDLQSI** rule (section [2.1.7.20.5](#)).

The query table that the **SxcQsi** class specifies information for is specified by **stName** field of the **SXAddl_SXCQsi_SXDId** record (section [2.4.273.62](#)).

If the **hdr.sxc** field of an **SXAddl** record (section [2.4.273.2](#)) equals SXCQSI (0x05), then the **hdr.sxd** field of the **SXAddl** record MUST be a value from the following table which specifies the full record type:

Name	Value	Full record type
SXDID	0x00	SXAddl_SXCQsi_SXDId

Name	Value	Full record type
SXDEND	0xFF	SXAddl_SXCQsi_SXDEnd (section 2.4.273.61)

2.2.5.1.1.1.7 SxcQuery Class

The **SxcQuery** class specifies additional information for an **external connection** (section [2.2.8](#)).

The **SxcQuery** class is specified by the sequence of records specified by the **SXADDLDBQUERY** rule (section [2.1.7.20.6](#)).

The **external connection** (section 2.2.8) the **SxcQuery** class specifies information for is specified by the **stURL** field of the **SXAddl_SXCQuery_SDXMLSource** record (section [2.4.273.67](#)).

If the **hdr.sxc** field of an **SXAddl** record (section [2.4.273.2](#)) equals SXCQUERY (0x06), then the **hdr.sxd** field of the **SXAddl** record MUST be a value from the following table which specifies the full record type:

Name	Value	Full record type
SDXMLSOURCE	0x04	SXAddl_SXCQuery_SDXMLSource
SXDSCRDATAFILE	0x05	SXAddl_SXCQuery_SXDsrcDataFile (section 2.4.273.66)
SXDSCRCONNFILE	0x06	SXAddl_SXCQuery_SXDsrcConnFile (section 2.4.273.65)
SXDRECONNCOND	0x07	SXAddl_SXCQuery_SXDReconnCond (section 2.4.273.64)
SXDEND	0xFF	SXAddl_SXCQuery_SXDEnd (section 2.4.273.63)

2.2.5.1.1.1.8 SxcGrpLevel Class

The **SxcGrpLevel** class specifies information for an **OLAP group level** (section [2.2.5.3.10](#)).

The **SxcGrpLevel** class is specified by the sequence of records specified by the **SXADDLGRPLEVEL** rule (section [2.1.7.20.5](#)).

The **OLAP group level** the **SxcGrpLevel** class specifies information for is specified by the **stUnique** field of the **SXAddl_SXCGrpLevel_SXDId** record (section [2.4.273.41](#)).

If the **hdr.sxc** field of an **SXAddl** record (section [2.4.273.2](#)) equals SXGRPLEVEL (0x07), then the **hdr.sxd** field of the **SXAddl** record MUST be a value from the following table which specifies the full record type:

Name	Value	Full record type
SXDID	0x00	SXAddl_SXCGrpLevel_SXDId
SXDGRPLEVELINFO	0x06	SXAddl_SXCGrpLevel_SXDGrpLevelInfo (section 2.4.273.40)
SXDEND	0xFF	SXAddl_SXCGrpLevel_SXDEnd (section 2.4.273.39)

2.2.5.1.1.1.9 SxcGroup Class

The **SxcGroup** class specifies information for an **OLAP grouping** (section [2.2.5.3.10](#)).

The **SxcGroup** class is specified by the sequence of records specified by the **SXADDLGROUP** rule (section [2.1.7.20.5](#)).

The **OLAP grouping** the **SxcGroup** class specifies information for is specified by the **stName** field of the **SXAddl_SXCGroup_SXDId** record (section [2.4.273.37](#)).

If the **hdr.sxc** field of an **SXAddl** record (section [2.4.273.2](#)) equals SXCGROUP (0x08), then the **hdr.sxd** field of the **SXAddl** record MUST be a value from the following table which specifies the full record type:

Name	Value	Full record type
SXDID	0x00	SXAddl_SXCGroup_SXDId
SXDGRPINFO	0x07	SXAddl_SXCGroup_SXDGrpInfo (section 2.4.273.36)
SXDMEMBER	0x08	SXAddl_SXCGroup_SXDMember (section 2.4.273.38)
SXDEND	0xFF	SXAddl_SXCGroup_SXDEnd (section 2.4.273.35)

2.2.5.1.1.1.10 SxcCacheItem Class

The **SxcCacheItem** class specifies additional information for a **cache item** (section [2.2.5.3.6](#)).

The **SxcCacheItem** class is specified by the sequence of records specified by the **SXADDLCACHEITEM** rule (section [2.1.7.20.3](#)).

The **cache item** that the **SxcCacheItem** class specifies information for is specified by the **dwItem** field of the **SXAddl_SXCItem_SXDId** record (section [2.4.273.21](#)).

If the **hdr.sxc** field of an **SXAddl** record (section [2.4.273.2](#)) equals SXCCACHEITEM (0x09), then the **hdr.sxd** field of the **SXAddl** record MUST be a value from the following table which specifies the full record type:

Name	Value	Full record type
SXDID	0x00	SXAddl_SXCItem_SXDId
SXDSXRMITMDISP	0x2E	SXAddl_SXCItem_SXDSxrmitmDisp (section 2.4.273.24)
SXDITMMPROPMAP	0x32	SXAddl_SXCItem_SXDitmMpropMap (section 2.4.273.23)
SXDITMMPMAPCOUNT	0x33	SxAddl_SXCItem_SXDitmMpMapCount (section 2.4.273.22)
SXDEND	0xFF	SXAddl_SXCItem_SXDEnd (section 2.4.273.20)

SXAddl_SXCItem_SXDEnd is a part of the **SxcCacheField** class (section [2.2.5.1.1.1.5](#)) and is not a **member (1)** of the **SxcCacheItem** class. **SXAddl_SXCItem_SXDEnd** specifies the end of a collection of **SxcCacheItem** classes.

2.2.5.1.1.1.11 SxcSxrule Class

The **SxcSxrule** class specifies a **PivotTable** rule (section [2.2.5.4.11](#)).

The **SxcSxrule class** is specified by the sequence of records specified by the **SXADDLSXRULE** rule (section [2.1.7.20.5](#)).

If the **hdr.sxc** field of an **SXAddl** record (section [2.4.273.2](#)) equals SXCRULE (0x0C), then the **hdr.sxd** field of the **SXAddl** record MUST be a value from the following table which specifies the full record type:

Name	Value	Full record type
SXDID	0x00	SXAddl_SXCSXrule_SXDId (section 2.4.273.98)
SXDSXRULE	0x13	SXAddl_SXCSXrule_SXDSXrule (section 2.4.273.99)
SXDEND	0xFF	SXAddl_SXCSXrule_SXDEnd (section 2.4.273.97)

2.2.5.1.1.1.12 SxcSXfilt Class

The **SxcSXfilt** class specifies information for a **PivotTable rule filter** (section [2.2.5.4.11](#)).

The **SxcSXfilt** class is specified by the sequence of records specified by the **SXADDLSXFILT** rule (section [2.1.7.20.5](#)).

If the **hdr.sxc** field of an **SXAddl** record (section [2.4.273.2](#)) equals SXCSXFILT (0x0D), then the **hdr.sxd** field of the **SXAddl** record MUST be a value from the following table which specifies the full record type:

Name	Value	Full record type
SXDID	0x00	SXAddl_SXCSXfilt_SXDId (section 2.4.273.76)
SXDSXFILT	0x14	SXAddl_SXCSXfilt_SXDSXfilt (section 2.4.273.77)
SXDSXITM	0x15	SXAddl_SXCSXfilt_SXDSXitm (section 2.4.273.78)
SXDEND	0xFF	SXAddl_SXCSXfilt_SXDEnd (section 2.4.273.75)

2.2.5.1.1.1.13 SxcSXDH Class

The **SxcSXDH** class specifies the **OLAP dimensions (1)** for **pivot hierarchies** (section [2.2.5.4.5](#)) in the **associated PivotTable view** (section [2.2.5.3.3](#)) of the **OLAP PivotCache** (section [2.2.5.3.4](#)). MUST NOT be present if the **PivotCache** (section [2.2.5.3](#)) is a non- **OLAP PivotCache**.

The **SxcSXDH** class is specified by the sequence of records specified by the **SXADDLSXDH** rule (section [2.1.7.20.3](#)).

If the **hdr.sxc** field of an **SXAddl** record (section [2.4.273.2](#)) equals SXCSXDH (0x10), then the **hdr.sxd** field of the **SXAddl** record MUST be a value from the following table which specifies the full record type:

Name	Value	Full record type
SXDID	0x00	SXAddl_SXCSXDH_SXDId (section 2.4.273.73)
SXDSXDH	0x1A	SXAddl_SXCSXDH_SXDSxdh (section 2.4.273.74)
SXDEND	0xFF	SXAddl_SXCSXDH_SXDEnd (section 2.4.273.72)

2.2.5.1.1.1.14 SxcAutoSort Class

The **SxcAutoSort** class specifies **pivot field sorting** (section [2.2.5.4.3.1](#)) information for a **pivot field** (section [2.2.5.4.3](#)).

The **SxcAutoSort** class is specified by the sequence of records specified by the **SXADDLAUTOSORT** rule (section [2.1.7.20.5](#)).

If the **hdr.sxc** field of an **SXAddl** record (section [2.4.273.2](#)) equals SXCAUTOSORT (0x12), then the **hdr.sxd** field of the **SXAddl** record MUST be a value from the following table which specifies the full record type:

Name	Value	Full record type
SXDID	0x00	SXAddl_SXCAutoSort_SXDId (section 2.4.273.4)
SXDEND	0xFF	SXAddl_SXCAutoSort_SXDEnd (section 2.4.273.3)

2.2.5.1.1.1.15 SxcSXMgs Class

The **SxcSXMgs** class specifies **OLAP measure groups**.

The **SxcSXMgs** class is specified by the sequence of records specified by the **SXADDLSXMGS** rule (section [2.1.7.20.3](#)).

If the **hdr.sxc** field of an **SXAddl** record (section [2.4.273.2](#)) equals SXCSXMGs (0x13), then the **hdr.sxd** field of the **SXAddl** record MUST be a value from the following table which specifies the full record type:

Name	Value	Full record type
SXDID	0x00	SXAddl_SXCSXMgs_SXDId (section 2.4.273.95)
SXDMGRPSXDHMAP	0x23	SXAddl_SXCSXMgs_SXDMGrpSXDHMap (section 2.4.273.96)
SXDEND	0xFF	SXAddl_SXCSXMgs_SXDEnd (section 2.4.273.94)

2.2.5.1.1.1.16 SxcSXMg Class

The **SxcSXMg** class specifies information for an **OLAP measure group**.

The **SxcSXMg** class is specified by the sequence of records specified by the **SXADDLSXMG** rule (section [2.1.7.20.3](#)).

The OLAP measure group that the **SxcSXMg** class specifies information for is specified by the **stName** field of the **SXAddl_SXCSXMg_SXDId** record (section [2.4.273.92](#)).

If the **hdr.sxc** field of an **SXAddl** record (section [2.4.273.2](#)) equals SXCSXMG (0x14), then the **hdr.sxd** field of the **SXAddl** record MUST be a value from the following table which specifies the full record type:

Name	Value	Full record type
SXDID	0x00	SXAddl_SXCSXMg_SXDId
SXDUSERCAPTION	0x1F	SXAddl_SXCSXMg_SXDUserCaption (section 2.4.273.93)
SXDEND	0xFF	SXAddl_SXCSXMg_SXDEnd (section 2.4.273.91)

2.2.5.1.1.1.17 SxcField12 Class

The **SxcField12** class specifies additional information for a **pivot field** (section [2.2.5.4.3](#)).

The **SxcField12** class is specified by the sequence of records specified by the **SXADDLFIELD12** rule (section [2.1.7.20.5](#)).

The **pivot field** that the **SxcField12** class specifies information for is specified by **stName** field of the **SXAddl_SXCField12_SXDId** record (section [2.4.273.30](#)).

If the **hdr.sxc** field of an **SXAddl** record (section [2.4.273.2](#)) equals SXCFIELD12 (0x17), then the **hdr.sxd** field of the **SXAddl** record MUST be a value from the following table which specifies the full record type:

Name	Value	Full record type
SXDID	0x00	SXAddl_SXCField12_SXDId
SXDVERUPDINV	0x01	SXAddl_SXCField12_SXDVerUpdInv (section 2.4.273.34)
SXDMEMBERCAPTION	0x11	SXAddl_SXCField12_SXDMemberCaption (section 2.4.273.32)
SXDVER12INFO	0x19	SXAddl_SXCField12_SXDVer12Info (section 2.4.273.33)
SXDISXTH	0x1C	SXAddl_SXCField12_SXDISXTH (section 2.4.273.31)
SXDAUTOSHOW	0x37	SXAddl_SXCField12_SXDAutoshow (section 2.4.273.28)
SXDEND	0xFF	SXAddl_SXCField12_SXDEnd (section 2.4.273.29)

2.2.5.1.1.1.18 SxcSXCondFmts Class

The **SxcSXCondFmts** class specifies information for **PivotTable** (section [2.2.5](#)) **conditional formatting** rules.

The **SxcSXCondFmts** class is specified by the sequence of records specified by the **SXADDLCONDGMTS** rule (section [2.1.7.20.5](#)).

If the **hdr.sxc** field of an **SXAddl** record (section [2.4.273.2](#)) equals SXCSXCONDFMTS (0x1A), then the **hdr.sxd** field of the **SXAddl** record MUST be a value from the following table which specifies the full record type:

Name	Value	Full record type
SXDID	0x00	SXAddl_SXCSXCondFmts_SXDId (section 2.4.273.71)
SXDEND	0xFF	SXAddl_SXCSXCondFmts_SXDEnd (section 2.4.273.70)

2.2.5.1.1.1.19 SxcSXCondFmt Class

The **SxcSXCondFmt** class specifies information for a **PivotTable** (section [2.2.5](#)) **conditional formatting** rule.

The **SxcSXCondFmt** class is specified by the sequence of records specified by the **SXADDLCONDGMT** rule (section [2.1.7.20.5](#)).

If the **hdr.sxc** field of an **SXAddl** record (section [2.4.273.2](#)) equals SXCSXCONDFMT (0x1B), then the **hdr.sxd** field of the **SXAddl** record MUST be a value from the following table which specifies the full record type:

Name	Value	Full record type
SXDSXCONDFMT	0x35	SXAddl_SXCSXCondFmt_SXDSXCondFmt (section 2.4.273.69)
SXDEND	0xFF	SXAddl_SXCSXCondFmt_SXDEnd (section 2.4.273.68)

2.2.5.1.1.1.20 SxcSXFilters12 Class

The **SxcSXFilters12** class specifies **advanced filters** (section [2.2.5.4.8.1](#)).

The **SxcSXFilters12** class is specified by the sequence of records specified by the **SXADDLXSFILTERS12** rule (section [2.1.7.20.5](#)).

If the **hdr.sxc** field of an **SXAddl** record (section [2.4.273.2](#)) equals SXCSXFILTERS12 (0x1C), then the **hdr.sxd** field of the **SXAddl** record MUST be a value from the following table which specifies the full record type:

Name	Value	Full record type
SXDID	0x00	SXAddl_SXCSXFilters12_SXDId (section 2.4.273.90)
SXDEND	0xFF	SXAddl_SXCSXFilters12_SXDEnd (section 2.4.273.89)

2.2.5.1.1.1.21 SxcSXFilter12 Class

The **SxcSXFilter12** class specifies an **advanced filters** (section [2.2.5.4.8.1](#)).

The **SxcSXFilter12** class is specified by the sequence of records specified by the **SXADDLSXFILTER12** rule (section [2.1.7.20.5](#)).

If the **hdr.sxc** field of an **SXAddl** record (section [2.4.273.2](#)) equals SXCSXFILTER12 (0x1D), then the **hdr.sxd** field of the **SXAddl** record MUST be a value from the following table which specifies the full record type:

Name	Value	Full record type
SXDID	0x00	SXAddl_SXCSXFilter12_SXDId (section 2.4.273.81)
SXDCAPTION	0x2F	SXAddl_SXCSXFilter12_SXDCaption (section 2.4.273.79)
SXDSXFILTER	0x38	SXAddl_SXCSXFilter12_SXDSXFilter (section 2.4.273.82)
SXDSXFILTERDESC	0x39	SXAddl_SXCSXFilter12_SXDSXFilterDesc (section 2.4.273.83)
SXDSXFILTERVALUE1	0x3A	SXAddl_SXCSXFilter12_SXDSXFilterValue1 (section 2.4.273.84)
SXDSXFILTERVALUE2	0x3B	SXAddl_SXCSXFilter12_SXDSXFilterValue2 (section 2.4.273.85)
SXDxlsFILTER	0x3C	SXAddl_SXCSXFilter12_SXDxlsFilter (section 2.4.273.86)
SXDxlsFILTERVALUE1	0x3D	SXAddl_SXCSXFilter12_SXDxlsFilterValue1 (section 2.4.273.87)
SXDxlsFILTERVALUE2	0x3E	SXAddl_SXCSXFilter12_SXDxlsFilterValue2 (section 2.4.273.88)
SXDEND	0xFF	SXAddl_SXCSXFilter12_SXDEnd (section 2.4.273.80)

2.2.5.2 Data Functionality Level

A **data functionality level** is a number that represents a set of features and run-time behaviors in the following areas related to data manipulation and display: **PivotTable** (section [2.2.5](#)), **query table**, and **external connections** (section [2.2.8](#)).

See section [2.2.5.3.1](#) for specific details about the **data functionality level** of a **PivotCache** (section [2.2.5.3](#)).

2.2.5.3 PivotCache

The **PivotCache** is a set of structures that contains information about the **source data** (section [2.2.5.3.2](#)) being summarized in the **PivotTable views** (section [2.2.5.4](#)) using that **PivotCache**. The information includes **source data** organization, data types, and the values. A PivotCache is specified by the records conforming to the following rules:

Rule	Notes
PIVOTCACHE (section 2.1.7.12)	This is in a stream as specified in section 2.1.7.12.
PIVOTCACHEDEFINITION (section 2.1.7.20.3)	The SXStreamID record (section 2.4.303) specifies the associated stream in section 2.1.7.12.
PIVOTFRT9 (section 2.1.7.20.5)	If an associated PivotTable view (section 2.2.5.3.3) is specified by the QsiSXTag record (section 2.4.211), then PivotCache properties specified in this rule apply to this PivotCache .

2.2.5.3.1 PivotCache Functionality Level

The **PivotCache functionality level** is the **data functionality level** (section [2.2.5.2](#)) associated with a **PivotCache** (section [2.2.5.3](#)). The **PivotCache functionality level** is used in specification of restrictions for the **PivotCache** and **associated PivotTable views** (section [2.2.5.3.3](#)). It is specified as follows:

- If an **SXAddl_SXCCache_SXDVerSXMacro** record (section [2.4.273.10](#)) exists, then the value of the **dwVer** field of the **SXAddl_SXCCache_SXDVerSXMacro** specifies the **PivotCache functionality level**.
- If an **SXAddl_SXCCache_SXDVerSXMacro** record does not exist and an **SXAddl_SXCView_SXDVer10Info** record (section [2.4.273.108](#)) exists for an **associated PivotTable views**, then the value of the **bVerSxMacro** field of the **SXAddl_SXCView_SXDVer10Info** record specifies the **PivotCache functionality level**, except if that value is greater than or equal to 3, in which case the **PivotCache functionality level** is specified to be 1.
- If an **SXAddl_SXCCache_SXDVerSXMacro** record does not exist and an **SXAddl_SXCView_SXDVer10Info** record does not exist for an **associated PivotTable views**, then the **PivotCache functionality level** is specified to be 0.

2.2.5.3.2 Source Data

A **PivotCache** (section [2.2.5.3](#)) can be based on four different types of **source data**. The type of **source data** is specified by the **sxvs** field of the **SXVS** record (section [2.4.317](#)).

When the **source data** type is SHEET as specified by **SXVS**, the data is read from the **range** specified by a **DConRef** (section [2.4.86](#)), **DConName** (section [2.4.85](#)), or **DConBin** (section [2.4.83](#)) record. If the range is a **table**, then the **PivotCache** will have one **cache field** (section [2.2.5.3.5](#)) for each column of the table using the column header captions for **cache field** names, and the **data region** values of the table are used as **source data** values, specified by **cache records** (section [2.2.5.3.12](#)). Otherwise the **PivotCache** has one **cache field** for each column of the range, using the values in the first row of the range for **cache field** names, and all other rows are used as **source data** values, specified by **cache records**.

When the **source data** type is SCENARIO as specified by **SXVS**, no new **source data** is available for the **PivotCache** and the **PivotCache** cannot be refreshed. A snapshot of the **source data** might be available in the **cache records**.

When the **source data** type is EXTERNAL, as specified by **SXVS**, the **source data** is read from an external **data source**. There is an associated **external connection** (section [2.2.8](#)) that is used to obtain data from the external data source. The **external connection** is specified by the sequence of records that conforms to the **DBQUERY** rule (section [2.1.7.20.3](#)) in the sequence of records that conforms to the **PIVOTCACHEDEFINITION** rule (section 2.1.7.20.3) and the combination of other records as specified in section 2.2.8. For a non-**OLAP PivotCache** (section [2.2.5.3.4](#)), the **source**

data is a rectangular table and the **PivotCache** (section 2.2.5.3) has one **cache field** for each column of the table using the column header captions for **cache field** names, and the rows of the table are used as **source data** values, specified by **cache records**.

If the source data is external and the external connection is an **OLAP Connection** (section 2.2.8.3.1) then the **PivotCache** MUST be an **OLAP PivotCache**. For an **OLAP PivotCache**, the **source data** is handled by the data provider specified by the associated **OLAP Connection** and the **PivotCache** MUST NOT have **cache records**.

When the **source data** type is CONSOLIDATION as specified by **SXVS**, the **source data** is read from one or more ranges. For more details, see the section 2.2.5.3.2.1.

When a **pivot field** (section 2.2.5.4.3) is on the **page axis** (section 2.2.5.4.9.1) of the **PivotTable view** (section 2.2.5.4), the **pivot field** is a server-based page field if the **fServerBased** field of the **SXVDEx** record (section 2.4.310) is equal to 1 and the **fServerBased** field of the associated **SXFDB** record (section 2.4.283) is equal to 1. A server-based page field is a **pivot field** on the **page axis** that causes the query that is used to retrieve **source data** for populating the **PivotCache** to be parameterized. The query is parameterized according to the page filter criteria, as specified in section 2.2.5.4.9.1. This feature can only be used for an **ODBC PivotCache**.

2.2.5.3.2.1 Multiple Consolidation Ranges

A **multiple consolidation ranges PivotCache** (section 2.2.5.3) is used for summarizing multiple **ranges** that contain **source data** in cross-tab format. A **multiple consolidation ranges PivotCache** is a collection of ranges and page information that is specified by the sequence of records that conforms to the **SXTBL** rule (section 2.1.7.20.3). Each range is specified by one of the **DConName** (section 2.4.85), **DConBin** (section 2.4.83), or **DConRef** (section 2.4.86) records.

The following figure shows an example of a range in cross-tab format. The first column of the range contains names of sales people ("George" and "Allan"). The first row in the range contains product groups ("Cars" and "Bikes"). The remaining **cells** in the range contain numeric values representing how many products in a certain product group were sold by each sales person.

	Cars	Bikes
George	1	2
Allan	3	4

Figure 3: Example of a range in cross-tab format

A **multiple consolidation ranges PivotCache** is used to summarize multiple cross-tab ranges as shown in the following figure, which shows eight cross-tab ranges.

	A	B	C	D	E	F	G
1	2006 Q1				2007 Q1		
2		Cars	Bikes			Cars	Bikes
3	George	1	2		George	17	18
4	Allan	3	4		Allan	19	20
5							
6	2006 Q2				2007 Q2		
7		Cars	Bikes			Cars	Bikes
8	George	5	6		George	21	22
9	Allan	7	8		Allan	23	24
10							
11	2006 Q3				2007 Q3		
12		Cars	Bikes			Cars	Bikes
13	George	9	10		George	25	26
14	Allan	11	12		Allan	27	28
15							
16	2006 Q4				2007 Q4		
17		Cars	Bikes			Cars	Bikes
18	George	13	14		George	29	30
19	Allan	15	16		Allan	31	32

Figure 4: Example of eight ranges in cross-tab format

The values in the first column of each range are used to create a **cache field** (section [2.2.5.3.5](#)) with a default name specified by the application. Each **cache item** (section [2.2.5.3.6](#)) of this **cache field** corresponds to one of the values in the first column of the range, eliminating duplicates. This **cache field** is the first **cache field** in the collection of sequences of records that conform to the **FDB** rule (section [2.1.7.12](#)) in the sequence of records that conforms to the **PIVOTCACHE** rule.

The values in the first row of each range are used to create a **cache field** with a default name specified by the application. Each **cache item** of this **cache field** corresponds to one of the values in the first row of the range, eliminating duplicates. This **cache field** is the second **cache field** in the collection of **FDB** rules (section [2.1.7.12](#)) in the **PIVOTCACHE** rule (section [2.1.7.12](#)).

The values in all other cells of each range are used to create a **cache field** with a default name specified by the application. Each **cache item** of this **cache field** corresponds to one of the values in the other cells of the range, eliminating duplicates. This **cache field** is the third **cache field** in the collection of **FDB** rules in **PIVOTCACHE** rule.

A **PivotTable view** (section [2.2.5.4](#)) associated with the **multiple** consolidation ranges **PivotCache** is added on creation. The **pivot fields** (section [2.2.5.4.3](#)) corresponding to the **cache fields** described previously are added to the **row axis** (section [2.2.5.4.9.2](#)), **column axis** (section [2.2.5.4.9.3](#)), and **data axis** (section [2.2.5.4.9.5](#)), respectively.

Up to four additional **cache fields** can optionally exist with default names specified by the application. The corresponding **pivot fields** are added to the **page axis** (section [2.2.5.4.9.1](#)) of the **PivotTable view** on creation, enabling the user to summarize data from all or a subset of the ranges. The ranges to be summarized in the **PivotTable** (section [2.2.5](#)) are selected by adding a **manual filter** (section [2.2.5.4.7](#)) to one or more of these **pivot fields** on the **page axis**. The number of optional **cache fields** created is user-defined and is equal to the **cPages** field of the **SXTbl** record (section [2.4.305](#)). Each optional **cache field** corresponds to an **SXTRGIITM** record.

The principal unit of scope is an **OLAP cube**. See section [2.2.8](#) for information about how an OLAP cube is accessed. Items within an OLAP cube can be addressed by an **MDX unique name** string. Within an OLAP cube, there are **OLAP hierarchies**, **OLAP measures** and **OLAP sets**.

An OLAP hierarchy consists of one or more **OLAP levels** and **OLAP member properties**. An OLAP level consists of one or more **OLAP members**. An OLAP member is an atomic unit of data, for example customer "Jim Smith", or a grouping of data, for example "customers in the city of Chicago". OLAP levels contain OLAP members of similar type within an OLAP hierarchy. OLAP members can have parent and child members in OLAP levels above and below them, for example "Jim Smith" might be a child of "customers in the city of Chicago". An OLAP member property can be associated with a single OLAP level or all OLAP levels of an OLAP hierarchy, for example a "Mayor" OLAP member property might be associated with a "City" OLAP level.

An **OLAP tuple** is a way of combining multiple OLAP members to reference a particular point in an OLAP cube, for example "customers in the city of Chicago" and "2008" references data in the OLAP cube corresponding to the year 2008 and customers in Chicago.

An OLAP measure is a value that is available in the OLAP cube. Usually it is numeric, "Sales" and "Head Count" are typical examples of OLAP measures. An OLAP measure is an OLAP member in a measures OLAP hierarchy. For a **PivotTable view** (section [2.2.5.4](#)), OLAP measures are stored differently from other OLAP members in this file format.

An OLAP tuple including an OLAP measure can be used to get a value, for example "customers in the city of Chicago", "2008" and "sales" might reference the value \$659,000.

An **OLAP named set** is a collection of OLAP tuples. OLAP named sets are typically used for specific analytical needs that require custom logic, for example an OLAP named set might be defined as the OLAP tuples corresponding to "the top 10 customers by month and sales".

2.2.5.3.5 Cache Fields

A **cache field** represents an entity by which data can be summarized.

Consider a **PivotCache** (section [2.2.5.3](#)) based on the following **source data** (section [2.2.5.3.2](#)):

Country	Product	Date	Sales
USA	Bicycle	6/5/2007	500
USA	Car	8/3/2007	20000
Canada	Bicycle	9/2/2007	300
Canada	Car	10/5/2007	35000

In this example, four **cache fields** exist in the **PivotCache**. Each **cache field** corresponds to one of the columns in the **source data**: Country, Product, Date, and Sales.

The sequence of records that conforms to the **FDB** rule (section [2.1.7.12](#)), and optionally the **SXADDLCACHEFIELD** rule (section [2.1.7.20.3](#)), specify a **cache field**. A **cache field** is contained in a **PivotCache**.

A cache field index is a zero-based index of an **FDB** rule in the **PIVOTCACHE** rule (section [2.1.7.12](#)).

A **cache field** typically corresponds to a **source data entity**. However, **grouping** (section [2.2.5.3.7](#)) **cache fields** and **cache fields** representing **calculated fields** (section [2.2.5.3.8](#)) do not correspond to **source data entities** (section [2.2.5.3.2](#)). Such **cache fields** are fully specified by information in the **PivotCache**.

The **cfdbdb** field of the **SXDB** record (section [2.4.275](#)) specifies the number of **cache fields** that correspond to **source data entities**. If the cache field index of an **SXFDB** record (section [2.4.283](#)) is less than **cfdbdb**, the cache field corresponds to a **source data entity**. Otherwise, the cache field does not correspond to a **source data entity**. A non- **OLAP PivotCache** (section [2.2.5.3.4](#)) **MUST** have one or more **cache fields** corresponding to **source data columns**. An **OLAP PivotCache** **MUST NOT** have **cache fields** that do not correspond to **source data entities**.

In a non- **OLAP PivotCache**, a cache field typically corresponds to one column in the **source data** and contains information about that column. The **cache** field name is specified by the **stFieldName** field of the **SXFDB** record. The **cache** field name of a cache field corresponding to a **source data column** is derived from the name of that column in the **source data** and is used to associate the **cache** field with that **source data column**.

All **cache field** names **MUST** be unique, when using a case-insensitive comparison, within the associated **PivotCache**.

In an **OLAP PivotCache** each **cache field** can be associated with a **pivot hierarchy** (section [2.2.5.4.5](#)). For more information, see section [2.2.5.4.5.1](#).

2.2.5.3.6 Cache Items

Cache items represent specific instances of the entities represented by **cache fields** (section [2.2.5.3.5](#)). For example, an instance of a Country **cache field** might be the USA **cache item**. Having a USA **cache item** in the Country **cache field** enables **PivotTable views** (section [2.2.5.4](#)) associated with the **PivotCache** (section [2.2.5.3](#)) to display data by USA.

Each cache item specifies its value and a type. In some cases, a **cache item** can have additional information associated with it.

A **cache item** is contained in a **cache field**. A **cache field** can have zero **cache items** if the **cache field** is not in use in the **PivotTable view**.

For a **cache field** that corresponds to **source data** (section [2.2.5.3.2](#)), a collection of cache items is specified by a collection of sequences of records that conform to the **SRCSXOPER** rule (section [2.1.7.12](#)), with each cache item being specified by a sequence of records that conforms to the **SXOPER** rule (section 2.1.7.12), which optionally has a sequence of records that conforms to the **SXADDLCACHEITEM** rule (section [2.1.7.20.3](#)) associated with it. The sequence of records that conforms to the **SXOPER** rule specifies the value of the cache item.

For **grouping** (section [2.2.5.3.7](#)) **cache fields**, the collection of cache items is specified by a collection of sequences of records that conform to the **GRPSXOPER** rule (section 2.1.7.12) with each cache item being specified by an **SXOPER** rule.

Calculated fields (section [2.2.5.3.8](#)) do not contain **cache items**.

A **cache item** index can be used to reference a **cache item** within the **cache field**. Referencing a **cache item** by index requires an implicit or explicit reference to that **cache field** because a **cache item** collection is associated with a specific **cache field**. A **cache field** can be referenced by a **cache field** index, as specified in section 2.2.5.3.5.

If a collection of **GRPSXOPER** rules exists in the cache field, a **cache item** index is a zero-based index into the collection of **GRPSXOPER** rules. Otherwise, a **cache item** index is a zero-based index into the collection of **SRCSXOPER** rules.

There can be multiple entries of **source data** that have the same combination of value and type for a **cache field**. Each **cache item** within a **cache field** **MUST** have a unique combination of value and type.

If there is one or more references by index to **cache** items of a particular **cache field**, that **cache field** MUST have a **cache items** collection. A **grouping cache field** MUST have a collection of **cache items** associated with it.

A **cache** item collection can contain unused **cache items**.

Unused **cache items** are values that did not exist in the **source data** when the **PivotCache** was last refreshed but existed when the **PivotCache** was refreshed previously. The **PivotCache** can retain such unused **cache items** to preserve information associated with them to reapply that information if the value corresponding to the **cache item** is added back to the **source data** at some later point in time.

For an **OLAP PivotCache** (section [2.2.5.3.4](#)), a **cache field** associated with an **OLAP measure** MUST NOT have a **cache** item collection.

For an **OLAP PivotCache**, a **cache item** with a string value specifies the unique name of an **OLAP member**, unless the **cache field** is a **member property** (section [2.2.5.4.6](#)) **cache field**.

An example of **cache items** and their association with **source data** is provided here.

Consider a **PivotCache** based on the following **source data** table:

Country	Product	Date	Sales
USA	Bicycle	6/5/2007	500
USA	Car	8/3/2007	20000
Canada	Bicycle	9/2/2007	500
Canada	Car	10/5/2007	35000

Four **cache fields** exist, each corresponding to one of the columns: Country, Product, Date, and Sales. Each of the four **cache fields** can have **cache items** corresponding to the unique values in the **source data columns** as illustrated in the following tables:

Cache items for the Country cache field
Canada
USA

Cache items for the Product cache field
Bicycle
Car

Cache items for the Date cache field
6/5/2007
8/3/2007

Cache items for the Date cache field
9/2/2007
10/5/2007

Cache items for the Sales cache field
500
20000
500
35000

2.2.5.3.7 Grouping

Grouping is used to combine a set of **cache items** (section [2.2.5.3.6](#)), typically ones that are related in some logical way. There are three different types of **grouping**: numeric grouping, date grouping, and discrete grouping. Numeric grouping combines numeric **cache items** into ranges of values. Date grouping combines date **cache items** into date ranges. Discrete grouping combines specifically selected **cache items** into groups.

The **cache field** (section [2.2.5.3.5](#)) that contains the **cache items** that are to be grouped is called the base **cache field**. The resultant **cache field** that contains the groups of **cache items** is called the parent grouping **cache field**. Each group of **cache items** in the base **cache field** is associated with a single **cache item** in the parent grouping **cache field**. Often **cache items** in parent grouping **cache fields** can be further grouped, creating a hierarchy of parent grouping **cache fields**. The base **cache field** is at the lowest level of the hierarchy.

Numeric grouping is specified by records in the **PivotCache Storage part** (section [2.1.7.12](#)) that conform to the **GRPSXOPER** (section [2.1.7.12](#)) and **SXRANGE** (section [2.1.7.12](#)) rules.

For numeric grouping, there is only one **cache field** associated with the grouping and it serves as both the parent grouping **cache field** and the base **cache field**. The numeric grouping is specified by the **fRangeGroup** and **fNumField** fields of the **SXFDB** record (section [2.4.283](#)) associated with the **cache field** being equal to 1. The **fHasParent** field of the **SXFDB** record MUST be 0.

The **cache items** that specify the groups are specified by **SXString** records (section [2.4.304](#)) that follow the **SXFDB** record. The grouping criteria is specified by the **SxRng** record (section [2.4.300](#)) that follows the **SXFDB** record. The **iByType** field of the **SxRng** record MUST be 0. For more details, see section [2.4.300](#).

Date grouping is specified by records in the **PivotCache Storage part** that conform to the **GRPSXOPER** and **SXRANGE** rules.

For date grouping, there can be up to seven levels of grouping hierarchy. The grouping level for a **cache field** is specified by the **iByType** field of the **SxRng** record that follows the **SXFDB** record which specifies that **cache field**. The **cache field** with the lowest **iByType** value has the finest level of detail, the **cache field** with the next lowest **iByType** value has the next finest level of detail, and so on. Each **cache field** in the hierarchy MUST have an **SxRng** record with a unique **iByType** value.

The **cache field** corresponding to the finest level of detail of date information included serves as both a parent grouping **cache field** and the base **cache field**. Other parent grouping **cache fields** specify

additional levels in the hierarchy. The date grouping is specified by the **fRangeGroup** and **fNumField** fields of the **SXFDB** record associated with the **cache field** being equal to 1 and 0 respectively for all **cache fields** in the grouping. The **ifdbBase** field of each **SXFDB** record associated with the date grouping, except for the **SXFDB** record corresponding to the base **cache field**, MUST specify a **cache field** index to the **SXFDB** record corresponding to the lowest level of the hierarchy.

The **cache items** that specify the groups are specified by **SXString** record that follow the **SXFDB** record for the parent grouping **cache fields**. The grouping criteria is specified by the **SxRng** record that follows the **SXFDB** record. The **iByType** field of the **SxRng** record MUST be greater than or equal to 1 (Seconds) and less than or equal to 7 (Years). For more details, see section 2.4.300.

Discrete grouping is specified by the **GRPSXOPER** rule, the **SxIsxoper** record (section 2.4.290), and the **Continue** records (section 2.4.58) in the **PivotCache Storage part**.

For discrete grouping, a hierarchy of parent grouping **cache fields** can exist, where each parent grouping **cache field** combines the **cache items** of the **cache field** at the next lower level. The discrete grouping is specified by the **fRangeGroup** field of the **SXFDB** record associated with the **cache field** being equal to 0 and the **csxoper** field of the **SXFDB** record being greater than 0. The **ifdbBase** field of the **SXFDB** record specifies a **cache field** index to the base **cache field** at the lowest level of the grouping hierarchy. The **ifdbParent** field of the **SXFDB** record specifies a **cache field** index to the parent grouping **cache field** at the next higher level of the hierarchy. If there is no higher level, then the **fHasParent** field of the **SXFDB** record MUST be 0 and **ifdbParent** MUST be ignored.

The **cache items** that specify the groups are specified by records that conform to the **GRPSXOPER** rule following the **SXFDB** record. The mapping between the **cache items** in the lower level **cache field** and the **cache items** in the parent grouping **cache field** is specified by the **SxIsxoper** record following the **SXFDB** record for the parent grouping **cache field**. The **rgSxIsxoper** field in the **SxIsxoper** record contains an array element for each **cache item** in the lower level **cache field**. The value of the array element is the index of the **cache item** in the parent grouping **cache field** that the **cache item** in the lower level **cache field** is grouped by. For more details, see section 2.4.290.

The following paragraphs explain the three different types of grouping and provide examples of them.

Numeric grouping combines numeric **cache items** into ranges of values. For example, consider the following PivotTable report where the number of people, represented by "Count of Name", of a certain age are listed.

Age	Count of Name
5	1
11	1
20	2
34	2
45	1
50	1
Grand Total	8

Figure 6: PivotTable report with ages

Analysis of specific ages might not be particularly meaningful. Instead, looking at age groups can be more interesting. The following **PivotTable** report (section 2.2.5) illustrates numeric grouping applied to the "Age" **cache field**. In this example, the numeric grouping is set to start at 0, end at 100, and have groups of 20 years.

Age	Count of Name
<0	
0-19	2
20-39	4
40-59	2
60-79	
80-100	
>100	
Grand Total	8

Figure 7: PivotTable report with age groups

Date grouping is similar to numeric grouping and is used to group **cache items** into date ranges.

One to seven parent grouping **cache fields** can exist when date grouping is applied to a **cache field**, each corresponding to a different level of detail of date and time information. The **cache field**, to which the date grouping is originally applied, is included in the set of parent grouping **cache fields** and is considered the base **cache field** of the parent grouping **cache fields**. For date grouping, the base **cache field** represents the finest level of detail of date and time information. The following levels of detail of date information are available, each corresponding to one **cache field**:

- Seconds
- Minutes
- Hours
- Days
- Months
- Quarters
- Years

For example, consider the following **PivotTable** report where the number of sales is listed for each individual date.

Date	# of Sales
1/1/2007	1
1/1/2008	16
2/2/2007	2
3/3/2007	3
4/4/2007	4
5/5/2007	5
6/6/2007	6
7/7/2007	7
8/8/2007	8
9/9/2007	9
10/10/2007	10
11/11/2007	11
12/12/2007	12
2/2/2008	17
3/3/2008	18
4/4/2008	19
5/5/2008	20
6/6/2008	21
7/7/2008	22
8/8/2008	23
9/9/2008	24
10/10/2008	25
11/11/2008	26
12/12/2008	27
Grand Total	336

Figure 8: PivotTable report with dates

This information can be too detailed for some analytical purposes. With date grouping, a more useful higher level summary can be created. The following PivotTable report illustrates the result of applying date grouping to the "Date" **cache field** and including two levels of grouping ("Years" and "Quarters"). In this example, the "Quarters" **cache field** represents the finest level of date information included and is therefore the base **cache field** for this date grouping. The "Years" **cache field** is a parent grouping **cache field** with the "Quarters" **cache field** as its base **cache field**. The items "<1/1/2007" in the two **cache fields** represent dates before 1/1/2007, where the start date is specified by the first **SXNum** record (section [2.4.296](#)) following the **SxRng** record. The items ">12/13/2008" in the two **cache fields** represent dates after 12/13/2008, where the end date is specified by the second **SXNum** record following the **SxRng** record.

Years - Quarters	# of Sales
<1/1/2007	
<1/1/2007	
2007	78
Qtr1	6
Qtr2	15
Qtr3	24
Qtr4	33
2008	258
Qtr1	51
Qtr2	60
Qtr3	69
Qtr4	78
>12/13/2008	
>12/13/2008	
Grand Total	336

Figure 9: PivotTable report with date groups

Discrete grouping combines specifically selected **cache items** into groups. When discrete grouping is applied to a **cache field**, a separate parent grouping **cache field** is created and the **cache field** that the grouping is applied to will become the base **cache field** for that parent grouping **cache field**. Multiple parent grouping **cache fields** can exist for one base **cache field**, forming a hierarchy of parent grouping **cache fields**. A parent grouping **cache field** higher in the hierarchy is considered the parent of the **cache field** just below it in the hierarchy. For a parent grouping **cache field**, each **cache item** in the **cache items** collection represents one group.

For example, consider the following **PivotTable** report listing sales by state in the Unites States.

Row Labels	Sum of Sales Amount
Alabama	\$37.29
Arizona	\$2,104.02
California	\$5,714,257.69
Florida	\$7,760.91
Georgia	\$1,658.92
Illinois	\$2,828.09
Kentucky	\$216.96
Massachusetts	\$2,049.10
Minnesota	\$91.28
Mississippi	\$82.59
Missouri	\$81.46
Montana	\$92.08
New York	\$4,124.19
North Carolina	\$7.28
Ohio	\$359.18
Oregon	\$1,170,991.54
South Carolina	\$2,434.92
Texas	\$1,789.10
Utah	\$4,419.58
Virginia	\$39.98
Washington	\$2,467,248.34
Wyoming	\$7,115.01
Grand Total	\$9,389,789.51

Figure 10: PivotTable report with state names

Discrete grouping can be used to group sets of states, for example, into geographical areas. The following PivotTable report illustrates the result of applying six groups ("Group1" through "Group6") to the **cache field** representing states. The **cache field** representing states is considered the base **cache field** for the discrete grouping in this example. Each group in the example, represented by a **cache item** in the parent grouping **cache field**, combines states in the same geographical area.

Row Labels	Sum of Sales Amount
Group1	\$3,000.83
Illinois	\$2,828.09
Minnesota	\$91.28
Missouri	\$81.46
Group2	\$6,532.47
Massachusetts	\$2,049.10
New York	\$4,124.19
Ohio	\$359.18
Group3	\$1,171,083.62
Montana	\$92.08
Oregon	\$1,170,991.54
Group4	\$2,478,782.93
Utah	\$4,419.58
Washington	\$2,467,248.34
Wyoming	\$7,115.01
Group5	\$12,238.85
Alabama	\$37.29
Florida	\$7,760.91
Georgia	\$1,658.92
Kentucky	\$216.96
Mississippi	\$82.59
North Carolina	\$7.28
South Carolina	\$2,434.92
Virginia	\$39.98
Group6	\$5,718,150.81
Arizona	\$2,104.02
California	\$5,714,257.69
Texas	\$1,789.10
Grand Total	\$9,389,789.51

Figure 11: PivotTable report with state groups

2.2.5.3.8 Calculated Fields

Calculated fields allow users to add calculations to a **PivotTable** report (section [2.2.5](#)). For example, if a **PivotTable** report contains values for sales and cost by products, but no profit values, a **calculated field** with the formula " =sales-cost " can be added so that profit values are calculated and can be analyzed in the **PivotTable** report.

A calculated field is a **cache field** (section [2.2.5.3.5](#)) and does not correspond to a column in the **source data** (section [2.2.5.3.2](#)). The values for a **calculated field** are calculated based on the formula specified for the **calculated field**. A **calculated field** is specified by the **fCalculatedField** field of the **SXFDB** record (section [2.4.283](#)) being equal to 1. The formula is specified by the **SXFormula** record (section [2.4.288](#)) following the **SXFDB** record.

A **pivot field** associated with a calculated field MUST NOT appear on the **row axis** (section [2.2.5.4.9.2](#)), **column axis** (section [2.2.5.4.9.3](#)), or **page axis** (section [2.2.5.4.9.1](#)) of a **PivotTable view** (section [2.2.5.4](#)).

An **OLAP PivotCache** (section [2.2.5.3.4](#)) MUST NOT have **calculated fields**.

2.2.5.3.9 Calculated Items

Calculated items allow users to add a **cache item** (section [2.2.5.3.6](#)) that does not exist in the **source data** (section [2.2.5.3.2](#)) to a **cache field** (section [2.2.5.3.5](#)). For example, consider a **PivotTable** report (section [2.2.5](#)) displaying sales for the four quarters of 2007. If there are **source data** rows for sales in 2008, a **calculated item** can be used to add an additional **cache item** as a calculated item that calculates the projected sales for the first quarter of the year 2008 as being 25% higher than the sales for the fourth quarter of 2007. The following figure illustrates a **PivotTable** report with such a **calculated item** (2008 Q1 projected).

Date	Sum of Sales
2007 Q1	\$4,000,000.00
2007 Q2	\$3,500,000.00
2007 Q3	\$5,000,000.00
2007 Q4	\$5,200,000.00
2008 Q1 projected	\$6,500,000.00
Grand Total	\$24,200,000.00

Figure 12: PivotTable report with a calculated item

The values for a **calculated item** are calculated based on the formula specified for the **calculated item**.

The sequence of records that conform to the **SXFORMULA** rule (section [2.1.7.12](#)) specifies one calculation for a specific **calculated item**. Each **calculated item** can have multiple calculations associated with it and in that case, there are multiple sequences of records that conform to the **SXFORMULA** rule corresponding to the same **calculated item**. The **calculated item** that a calculation is associated with is specified by the sequence of records that conform to the **PIVOTRULE** rule (section [2.1.7.20.6](#)) in the **SXFORMULA** rule. The **PIVOTRULE** rule can also specify additional scoping information. For example, if one calculation for a calculated item named "2008 Q1 projected" only applies to the "Cars" product group, the **PIVOTRULE** rule will specify the **cache field** corresponding to "product group" and the **cache item** corresponding to "Cars".

An **OLAP PivotCache** (section [2.2.5.3.4](#)) MUST NOT have **calculated items**.

2.2.5.3.10 OLAP Grouping

Grouping in an **OLAP PivotCache** (section [2.2.5.3.4](#)) is the associating of multiple **OLAP members** that belong to the same **OLAP level** of an **OLAP hierarchy** and have the same OLAP member parent. When OLAP members in a particular OLAP level are grouped, a parent grouping OLAP level exists. Each group is represented in the parent grouping OLAP level by one parent grouping OLAP member, and one or more child OLAP members in the OLAP level that the grouping is applied to.

A parent grouping OLAP level is specified by the sequence of records that conform to the **SXADDLGRPLEVEL** rule (section [2.1.7.20.5](#)).

A parent grouping OLAP member is specified by the sequence of records that conform to the **SXADDLGROUP** rule (section [2.1.7.20.5](#)).

2.2.5.3.11 OLAP Calculated Members

A calculated **member (2)** is specified by the sequence of records that conform to the **SXADDLCALCMEMBER** rule (section [2.1.7.20.5](#)) and is used to create an **OLAP calculated member** or an **OLAP named set** with an associated user-specified **MDX expression** for a custom calculation.

If the **fLongFormula** field of the **SXAddl_SXCView_SXDCalcMember** record (section [2.4.273.100](#)) is equal to one, then the **stMDXFormula** field of the **SXAddl_SXCView_SXDCalcMemString** record (section [2.4.273.101](#)) specifies the user-specified MDX expression. If the **fLongFormula** field of the **SXAddl_SXCView_SXDCalcMember** record is equal to zero, then the **stMDXFormula** field of the **SXAddl_SXCView_SXDCalcMember** record specifies the MDX expression.

The **fSet** field of the **SXAddl_SXCView_SXDCalcMember** record specifies whether the associated calculated member (2) creates an OLAP named set or an OLAP calculated member.

If the user-specified MDX expression associated with a calculated member (2) defines an **OLAP measure**, then this calculated member (2) is associated with a measure **pivot hierarchy** (section [2.2.5.4.5](#)) as specified in section [2.2.5.4.5.2](#).

If the user-specified MDX expression associated with a calculated member (2) specifies an **OLAP member** in an **OLAP hierarchy** other than the OLAP measure hierarchy, then this calculated member (2) can only be associated with a **cache item** (section [2.2.5.3.6](#)).

If a calculated member specifies an OLAP named set, then this calculated member (2) is associated with a named set **pivot hierarchy** as specified in section [2.2.5.4.5.4](#).

2.2.5.3.12 Cache Records

Cache records, as defined by the **Pivot Cache Storage** (section [2.1.7.12](#)), represent a copy of the **source data** (section [2.2.5.3.2](#)) for a **PivotCache** (section [2.2.5.3](#)) and allow for **PivotTable views** (section [2.2.5.4](#)) using a **PivotCache** to be recalculated without retrieving the **source data**.

Each **cache** record specifies values for one row of **source data**. Each value in a **cache** record is associated with a corresponding **cache field** (section [2.2.5.3.5](#)). **Cache records** are specified by the sequence of records that conform to the **DBB** rule (section [2.1.7.12](#)). The count of **cache records** MUST be equal to the **crdbdb** field of the **SXDB** record (section [2.4.275](#)). The **SXDBB** record (section [2.4.276](#)) specifies an array of **cache item** (section [2.2.5.3.6](#)) indexes for the **cache fields** for which the **fAllAtoms** field of the **SXFDB** record (section [2.4.283](#)) is equal to 1. The values for the remaining **cache fields** that correspond to **source data** columns are specified by the sequence of records that conform to the **SXOPER** rule (section [2.1.7.12](#)), with each record specifying a value. For each **cache** record, the number of records in the sequence of records that conforms to the **SXOPER** rule (section [2.1.7.12](#)) MUST be the same as the count of **cache fields**, corresponding to **source data** columns, for which the **fAllAtoms** field of the **SXFDB** record is equal to 0.

The **cache records** in a **PivotCache** can be invalid, in which case the **cache records** MUST be ignored. The validity of the **cache records** is determined from the **SXAddl_SXCCache_SXDInvRefreshReal** record (section [2.4.273.8](#)), if one is present and associated with this **PivotCache**, the **QsiSXTag** record (section [2.4.211](#)), if one is present and associated with this **PivotCache**, and the **SXDB** record. If the **SXAddl_SXCCache_SXDInvRefreshReal** record is present, then the **cache records** are not valid if the **fInvalid** field of the **SXAddl_SXCCache_SXDInvRefreshReal** record is 1 and valid if that field is 0. Otherwise, if the **QsiSXTag** record is present, then the **cache records** are not valid if the **fInvalid** field of the **QsiSXTag** record is 1 and valid if that field is 0. Otherwise, the **cache records** are not valid if the **fInvalid** field of the **SXDB** record is 1 and valid if that field is 0.

An **OLAP PivotCache** (section [2.2.5.3.4](#)) MUST NOT have **cache records**. **Cache records** are optional for a non- **OLAP PivotCache**.

2.2.5.4 PivotTable View

A PivotTable view is a set of structures that specify layout, filtering, and other properties. These properties are used to produce a **PivotTable** report (section [2.2.5](#)) based on data from the associated **PivotCache** (section [2.2.5.3](#)).

A **PivotTable view** is specified by the sequence of records that conform to the **PIVOTVIEW** rule (section [2.1.7.20.5](#)).

Functionality specified by a **PivotTable view** includes:

- The arrangement of **pivot fields** (section [2.2.5.4.3](#)) on the **row axis** (section [2.2.5.4.9.2](#)), **column axis** (section [2.2.5.4.9.3](#)), or both to produce a **PivotTable** report.
- Using **data items** (section [2.2.5.4.9.5.1](#)) on the **data axis** (section [2.2.5.4.9.5](#)) to show summarized result values in the **PivotTable** report.
- Filtering the data in the **PivotTable** report by performing manual filtering (section [2.2.5.4.7](#)), filtering by criteria (section [2.2.5.4.8](#)), or filtering in the **page axis** (section [2.2.5.4.9.1](#)).
- Determining the **PivotTable layout** (section [2.2.5.4.10](#)).
- Formatting the entire **PivotTable** report with a **table style** (section [2.4.320](#)). See the **SXAddl_SXCView_SXDTableStyleClient** report (section [2.4.273.107](#)) for details. Alternatively, for an **AutoFormat**, see section [2.4.313](#) and section [2.4.315](#) for details.
- Formatting an area of the **PivotTable** report in a way that logically tracks changes in the **PivotTable** report. For details, see the record specifications for records specified by the **PIVOTFORMAT** rule (section [2.1.7.20.5](#)).
- **Conditional formatting** an area of the **PivotTable** report in a way that logically tracks changes in the **PivotTable** report and performs calculations based the fact that the area is in a **PivotTable** report. For details, see the record specifications for records specified by the **SXADDLCONDfmt** rule (section [2.1.7.20.5](#)).
- Sorting **pivot items** (section [2.2.5.4.4](#)) of **pivot fields** (section [2.2.5.4.3](#)) within the **PivotTable** report. For details, see section [2.2.5.4.3.1](#).

2.2.5.4.1 Associated PivotCache

A **PivotTable view** (section [2.2.5.4](#)) is associated with the **PivotCache** (section [2.2.5.3](#)) specified by the **iCache** field of the **SxView** record (section [2.4.313](#)). **iCache** is a zero-based index of a sequence of records that conform to the **PIVOTCACHEDEFINITION** rule (section [2.1.7.20.3](#)) in the sequence of records that conform to the **WORKBOOKCONTENT** rule (section [2.1.7.20.3](#)).

Each **PivotTable view** MUST be associated with exactly one **PivotCache**. A non- **OLAP PivotCache** (section [2.2.5.3.4](#)) MUST be associated with one or more **PivotTable views**. An **OLAP PivotCache** MUST be associated with exactly one **PivotTable view**.

2.2.5.4.2 OLAP PivotTable view

A **PivotTable view** (section [2.2.5.4](#)) is specified to be an **OLAP PivotTable view** if a **QsiSXTag** record (section [2.4.211](#)) exists for the **PivotTable view** and the **fTensorEx** bit of the **QsiSXTag** record is 1. Otherwise, the **PivotTable view** is specified to be a non-**OLAP PivotTable view**. An **OLAP PivotTable view** has an **OLAP PivotCache** (section [2.2.5.3.4](#)) as its associated **PivotCache** (section [2.2.5.3](#)).

2.2.5.4.3 Pivot Fields

A **pivot field** corresponds to a **cache field** (section [2.2.5.3.5](#)). A **pivot field** specifies display information of the data in the **PivotTable view** (section [2.2.5.4](#)).

A **pivot field** is specified by a sequence of records that conforms to the **PIVOTVD** rule (section [2.1.7.20.5](#)) and optionally the **PIVOTVDTEX** (section [2.1.7.20.5](#)) and **SXADDFIELD** (section [2.1.7.20.5](#)) rules. The **PIVOTVDTEX** rule specifies additional properties for **OLAP PivotTable** views (section [2.2.5.4.2](#)), and the **SXADDFIELD** rule (section [2.1.7.20.5](#)) specifies additional version specific properties. A pivot field is contained in the **PivotTable view**. A **PivotTable view** contains a collection of **pivot fields** which is specified by the sequence of records that conforms to the **PIVOTVIEW** rule (section [2.1.7.20.5](#)).

A pivot field index, which identifies a pivot field, is specified as the zero-based index of a **PIVOTVD** rule in the collection specified by a **PIVOTVIEW** rule.

Each **pivot field** is associated with the **cache field** with a **cache field** index equal to the **pivot field** index of this **pivot field**. For more details, see section [2.2.5.3.5](#). The number of pivot fields in the sequence of records that conforms to a **PIVOTCORE** rule (section [2.1.7.20.5](#)) **MUST** be equal to the number of **cache fields** in the **associated PivotCache** (section [2.2.5.4.1](#)) for the **PivotTable view**.

A **PivotTable view** is used to create a **PivotTable** report (section [2.2.5](#)). This can include information about **pivot fields** placed on **PivotTable axes** (section [2.2.5.4.9](#)) and **data items** (section [2.2.5.4.9.5.1](#)) referring to **pivot fields**.

A **pivot field** can have **pivot items** (section [2.2.5.4.4](#)). A **pivot field** can describe information such as **pivot field sorting** (section [2.2.5.4.3.1](#)) and **subtotaling** (section [2.2.5.4.9.4.2](#)) settings.

The following figure shows a **PivotTable** report with three pivot fields displaying Sales by Country and Fiscal Year.

Sales	Fiscal Year					
Country	FY 2002	FY 2003	FY 2004	FY 2005	Grand Total	
Australia	\$2,568,701.39	\$2,099,585.43	\$4,383,479.54	\$9,234.23	\$9,061,000.58	
Canada	\$573,100.97	\$305,010.69	\$1,088,879.50	\$10,853.70	\$1,977,844.86	
France	\$414,245.32	\$633,399.70	\$1,592,880.75	\$3,491.95	\$2,644,017.71	
Germany	\$513,353.17	\$593,247.24	\$1,784,107.09	\$3,604.83	\$2,894,312.34	
United Kingdom	\$550,507.33	\$696,594.97	\$2,140,388.50	\$4,221.41	\$3,391,712.21	
United States	\$2,452,176.07	\$1,434,296.26	\$5,483,882.67	\$19,434.51	\$9,389,789.51	
Grand Total	\$7,072,084.24	\$5,762,134.30	\$16,473,618.05	\$50,840.63	\$29,358,677.22	

Figure 13: PivotTable report with three pivot fields: Sales, Country, and Fiscal Year

2.2.5.4.3.1 Pivot Field Sorting

A **Pivot Field** (section [2.2.5.4.3](#)) has a **sort order** specified if the **PivotTable** (section [2.2.5](#)) is recalculated and the **Pivot Field** (section [2.2.5.4.3](#)) is on the **row axis** (section [2.2.5.4.9.2](#)) or **column axis** (section [2.2.5.4.9.3](#)).

A **Pivot Field** is sorted depending on the setting of the **fAutoSort** field of **SXVDEx** (section [2.4.310](#)).

If the **fAutoSort** field of **SXVDEx** is equal to 0, then the sort order is specified depending on the value of the **fTensorSort** field of **SXVDTEX** record (section [2.4.311](#)) of the **Pivot Field**.

fTensorSort field of SXVDTEX	Meaning
0 or SXVDTEX record not present	The order is determined by the order of the SXVI records (section 2.4.312) for this Pivot Field .

fTensorSort field of SXVDEx	Meaning
1	The order is determined by the OLAP data source . Only valid for an OLAP PivotTable view (section 2.2.5.4.2).

If the **fAutoSort** field of **SXVDEx** is equal to 1, then sorting is in ascending or descending order according to the **fAscendSort** field of **SXVDEx**. What is sorted depends on the following:

SxcAutoSort class of pivot field presence	isxdiAutoSort field of SXVDEx	Meaning
Not Present	Greater than or equal to 0	Sorting is based on the values in the cells in the PivotTable data area (section 2.2.5.4.10.1.4) that are specified by the data item (section 2.2.5.4.9.5.1) referenced by the isxdiAutoSort field of SXVDEx .
Not Present	-1	Sorting is based on the values of the pivot items (section 2.2.5.4.4) themselves.
Present		Sorting is either based on the values in the cells in the PivotTable data area or on the values of member properties (section 2.2.5.4.6) associated with this pivot field as specified by the SxcSXR class (section 2.2.5.1.1.1.11) in the SxcAutoSort class (section 2.2.5.1.1.1.14).

2.2.5.4.4 Pivot Items

Pivot items represent specific instances of the entities represented by **pivot fields** (section [2.2.5.4.3](#)). Each **pivot item** specifies its display properties. For example, it can contain the user defined caption for the **pivot item** or information about whether this **pivot item** is hidden or not.

A **pivot item** specifies view properties of a **cache item** (section [2.2.5.3.6](#)) or of an aggregation value associated with a **pivot fields** (section [2.2.5.4.3](#)).

A pivot item is specified by an **SXVI** record (section [2.4.312](#)) in a sequence of records that conforms to the **PIVOTVD rule** (section [2.1.7.20.5](#)), and optionally an **SXVIFlags structure** (section [2.5.263](#)) specified by an element in the array specified by the **rgsxvi** field of the **SXVDEx** record (section [2.4.311](#)). The **SXVIFlags structure** (section [2.5.263](#)) specifies additional properties for **OLAP PivotTable views** (section [2.2.5.4.2](#)).

If the **itmType** field of **SXVI** (section [2.4.312](#)) is 0x0000, then this **pivot item** is associated with the **cache item** (section [2.2.5.3.6](#)) specified by the **iCache** field of the **SXVI** record (section [2.4.312](#)). Each **pivot item** that is associated with a **cache item** (section [2.2.5.3.6](#)) MUST be associated with a different **cache item** (section [2.2.5.3.6](#)) than the other **pivot items** in the collection. If the **itmType** field of this **SXVI** record (section [2.4.312](#)) is not 0x0000, then this **pivot item** MUST NOT have an associated **cache item** (section [2.2.5.3.6](#)).

The number of **pivot items** where the **itmType** field of the **SXVI** record (section [2.4.312](#)) of the **pivot item** is 0x0000 MUST equal zero or the number of **cache items** (section [2.2.5.3.6](#)) in the **cache field** (section [2.2.5.3.5](#)) of the **pivot fields** (section [2.2.5.4.3](#)).

A pivot item can be referenced by a pivot item index. A pivot item index is a zero-based index of **SXVI** records (section [2.4.312](#)) in a **PIVOTVD rule** (section [2.1.7.20.5](#)). Note that unlike pivot field index and cache field index, **pivot item** index and cache item index are not necessarily equal.

2.2.5.4.5 Pivot Hierarchies

A **pivot hierarchy** is specified to be contained by a **PivotTable axis** (section [2.2.5.4.9](#)) when all **pivot fields** (section [2.2.5.4.3](#)) associated with that pivot hierarchy are placed on that **PivotTable axis** (section [2.2.5.4.9](#)). **Pivot fields** (section [2.2.5.4.3](#)) MUST NOT be placed on a **PivotTable axis** (section [2.2.5.4.9](#)) different from the pivot axis that any other **pivot field** (section [2.2.5.4.3](#)) associated with the same pivot hierarchy is placed on. Additional restrictions can apply, as specified by the **SXTH rule** (section [2.1.7.20.5](#)) and the PivotTable Axes section.

A **pivot hierarchy** corresponds to one of the following entities in the **OLAP source data** (section [2.2.5.3.2](#)) associated with an **OLAP PivotCache** (section [2.2.5.3.4](#)):

- **OLAP hierarchy**
- **OLAP measure**
- **OLAP named set**
- **OLAP key performance indicator (KPI)**

A **pivot hierarchy** is associated with an OLAP hierarchy in the **source data** (section [2.2.5.3.2](#)). A pivot hierarchy is specified by the sequence of records that conform to the **PIVOTTH rule** (section [2.1.7.20.5](#)) and, optionally, the **SXADDLHIERARCHY rule** (section [2.1.7.20.5](#)).

Pivot hierarchies MUST NOT exist if the **PivotTable view** (section [2.2.5.4](#)) is a non- **OLAP PivotTable views** (section [2.2.5.4.2](#)). At least one **pivot hierarchy** MUST exist if the **PivotTable view** (section [2.2.5.4](#)) is an **OLAP PivotTable views** (section [2.2.5.4.2](#)).

A **pivot hierarchy** specifies OLAP hierarchy information and has one or more associated **pivot fields** (section [2.2.5.4.3](#)) associated with **OLAP levels** of the OLAP hierarchy, an OLAP named set, an **OLAP KPI**, or an OLAP measure.

A pivot hierarchy can be referenced by pivot hierarchy index. A pivot hierarchy index is the zero-based index of a **PIVOTTH rule** (section [2.1.7.20.5](#)) in the associated **PIVOTVIEW rule** (section [2.1.7.20.5](#)).

A pivot hierarchy is associated with an OLAP object as specified in the following table:

fMeasure field of SXTH	fSet field of SXTH	fKPI field of SXTH	Meaning
0	0	0	OLAP hierarchy
0	1	0	OLAP named set
0	0	1	OLAP KPI
1	0	0	OLAP measure

2.2.5.4.5.1 Association of Pivot Hierarchies and Pivot Fields and Cache Fields

A **pivot field** (section [2.2.5.4.3](#)) is associated with the **pivot hierarchy** (section [2.2.5.4.5](#)) specified by either the **isxth** field of the **SXVDTEEx record** (section [2.4.311](#)) of that **pivot field** (section [2.2.5.4.3](#)), or the **isxth** field of the **SXAddl_SXCField12_SXDISXTH record** (section [2.4.273.31](#)) of that **pivot field** (section [2.2.5.4.3](#)).

If a **pivot field** (section [2.2.5.4.3](#)) has an **SXAddl_SXCField12_SXDISXTH record** (section [2.4.273.31](#)), the **isxth** field of the **SXVDTEEx record** (section [2.4.311](#)) MUST be -1 and the association is specified by **isxth** field of the **SXAddl_SXCField12_SXDISXTH record** (section [2.4.273.31](#)).

A **pivot hierarchy** (section 2.2.5.4.5) associated with a **pivot field** (section 2.2.5.4.3) is associated with the **cache field** (section [2.2.5.3.5](#)) the **pivot field** (section 2.2.5.4.3) is associated.

If a **pivot hierarchy** (section 2.2.5.4.5) is on the **page axis** (section [2.2.5.4.9.1](#)) or **data axis** (section [2.2.5.4.9.5](#)), the **isxvd** field of **SXTH** (section [2.4.308](#)) is a reference to an associated **pivot field** (section 2.2.5.4.3).

If the **pivot hierarchy** (section 2.2.5.4.5) is not a **measure** (section [2.2.5.4.5.2](#)), **named set** (section [2.2.5.4.5.4](#)), **KPI** (section [2.2.5.4.5.3](#)), there can be more than one **pivot field** (section 2.2.5.4.3) associated with it and each array elements in the **rgisxvd** field of **SXTH** (section 2.4.308) is a reference to the associated **pivot field** (section 2.2.5.4.3) for the **pivot hierarchy** (section 2.2.5.4.5) level.

If a **pivot field** (section 2.2.5.4.3) has an **SXAddl_SXCField12_SXDISXTH record** (section 2.4.273.31) **sxaxis.sxaxisData**, **sxaxis.sxaxisRw**, **sxaxis.sxaxisCol** and **sxaxis.sxaxisPage** fields of the **Sxvd record** (section [2.4.309](#)) of the **pivot field** (section 2.2.5.4.3) MUST be 0.

If a **pivot hierarchy** (section 2.2.5.4.5) is a **measure** (section 2.2.5.4.5.2), **named set** (section 2.2.5.4.5.4), or **KPI** (section 2.2.5.4.5.3), there can be no more than one **pivot field** (section 2.2.5.4.3) associated with it.

2.2.5.4.5.2 Measures

A measure pivot hierarchy is a pivot hierarchy that is associated with an **OLAP measure**. The **fMeasure** field of the **SXTH** (section [2.4.308](#)) specifies if a pivot hierarchy is a **measure** pivot hierarchy. An OLAP measure MUST NOT have more than one **cache field** (section [2.2.5.3.5](#)) associated with it. A **measure** pivot hierarchy MUST NOT be located on the **row axis** (section [2.2.5.4.9.2](#)), **column axis** (section [2.2.5.4.9.3](#)), or **page axis** (section [2.2.5.4.9.1](#)).

2.2.5.4.5.3 KPIs

A **key performance indicator (KPI) pivot hierarchy** (section [2.2.5.4.5](#)) is a **pivot hierarchy** (section 2.2.5.4.5) that is associated with an **OLAP KPI**. A **KPI pivot hierarchy** (section 2.2.5.4.5) includes the four main components of an OLAP KPI; value, goal, status and trend. The **fKPI** field of the **SXTH record** (section [2.4.308](#)) specifies if a pivot hierarchy is a **KPI pivot hierarchy** (section 2.2.5.4.5).

2.2.5.4.5.4 Named Sets

A **named set pivot hierarchy** (section [2.2.5.4.5](#)) is a **pivot hierarchy** (section 2.2.5.4.5) that is associated with an **OLAP named set**. The **fSet** field of the **SXTH record** (section [2.4.308](#)) specifies if a **pivot hierarchy** (section 2.2.5.4.5) is a **named set pivot hierarchy** (section 2.2.5.4.5). An OLAP named set MUST NOT have more than one **cache field** (section [2.2.5.3.5](#)) associated with it. A **named set pivot hierarchy** (section 2.2.5.4.5) MUST NOT be located on the **data axis** (section [2.2.5.4.9.5](#)) or **page axis** (section [2.2.5.4.9.1](#)).

2.2.5.4.6 Member Properties

A **member property** is the **PivotTable** (section [2.2.5](#)) representation of an **OLAP member property**. **Member properties** can have properties that are associated with the **PivotCache** (section [2.2.5.3](#)) and a **PivotTable view** (section [2.2.5.4](#)).

A **member property** is specified by the **SXAddl_SXCHierarchy_SXDProperty record** (section [2.4.273.57](#)) in the sequence of records that conform to the **SXADDLHIERARCHY rule** (section [2.1.7.20.5](#)). A **member property** is contained in a **pivot hierarchy** (section [2.2.5.4.5](#)).

A **member property** is associated with one OLAP member property of the **OLAP hierarchy** specified by the **pivot hierarchy** (section 2.2.5.4.5) of the **member property**.

A **member property** can be associated with a **cache field** (section [2.2.5.3.5](#)) and a **pivot field** (section [2.2.5.4.3](#)). If there is a **cache field** (section [2.2.5.3.5](#)) with an **stFieldName** field of the **SXFDB** record equal to the **stProperty** field of the **SXAddl_SXCHierarchy_SXDProperty** record (section [2.4.273.57](#)), then this specifies that the **member property** is associated with that **cache field** (section [2.2.5.3.5](#)), and the **cache field** (section [2.2.5.3.5](#)) is specified to be a **member property cache field** (section [2.2.5.3.5](#)). The associated **pivot field** (section [2.2.5.4.3](#)) of a **member property cache field** (section [2.2.5.3.5](#)) is specified to be a **member property pivot field** (section [2.2.5.4.3](#)).

It is not required that a **member property** is associated with any **cache field** (section [2.2.5.3.5](#)) or **pivot field** (section [2.2.5.4.3](#)). If there is no **cache field** (section [2.2.5.3.5](#)) with a **stFieldName** field of the **SXFDB** record (section [2.4.283](#)) equal to the **stProperty** field of the **SXAddl_SXCHierarchy_SXDProperty** record (section [2.4.273.57](#)), then this specifies that the **member property** is not associated with any **cache field** (section [2.2.5.3.5](#)) or **pivot field** (section [2.2.5.4.3](#)). Such a **member property** does not participate in the **row axis** (section [2.2.5.4.9.2](#)) or **column axis** (section [2.2.5.4.9.3](#)).

A **member property pivot field** (section [2.2.5.4.3](#)) can be shown only in the **row area** (section [2.2.5.4.10.1.1](#)) or **column area** (section [2.2.5.4.10.1.2](#)) of a **PivotTable view** (section [2.2.5.4](#)). A **member property pivot field** (section [2.2.5.4.3](#)) can only be shown after the last visible level of the corresponding **pivot hierarchy** (section [2.2.5.4.5](#)). The order of **member property** fields shown in the **PivotTable view** (section [2.2.5.4](#)) is the same as the order of **SXAddl_SXCHierarchy_SXDProperty** records (section [2.4.273.57](#)) in the corresponding **pivot hierarchy** (section [2.2.5.4.5](#)).

2.2.5.4.7 Manual Filters

A manual filter enables specific **pivot items** (section [2.2.5.4.4](#)) or **OLAP members** associated with **pivot fields** (section [2.2.5.4.3](#)) to be shown or hidden in the **PivotTable report** (section [2.2.5](#)). **Manual filtering** affects calculations when **pivot fields** (section [2.2.5.4.3](#)) that have **manual filters** are located on the **row axis** (section [2.2.5.4.9.2](#)), **column axis** (section [2.2.5.4.9.3](#)), or **page axis** (section [2.2.5.4.9.1](#)). The **pivot items** (section [2.2.5.4.4](#)) that are hidden for such **pivot fields** (section [2.2.5.4.3](#)) are not included when calculating values for the **PivotTable view** (section [2.2.5.4](#)).

At least one **SXVI** record (section [2.4.312](#)) following an **Sxvd** record (section [2.4.309](#)) MUST have the **fHidden** field equal to 0x0.

Details about manual **filtering** for **pivot fields** (section [2.2.5.4.3](#)) on the **page axis** (section [2.2.5.4.9.1](#)) are covered in the Page Axis section.

2.2.5.4.7.1 Non-OLAP Manual Filters

For non-**OLAP PivotTable views** (section [2.2.5.4.2](#)), the state of the **manual filter** (section [2.2.5.4.7](#)) on a **pivot field** (section [2.2.5.4.3](#)) can be determined by the value of the **fHidden** field of the **SXVI** records (section [2.4.312](#)) directly following the corresponding **Sxvd** record (section [2.4.309](#)). This field specifies whether the corresponding **pivot items** (section [2.2.5.4.4](#)) is shown or hidden in the **PivotTable report** (section [2.2.5](#)).

For non-**OLAP PivotTable** (section [2.2.5](#)) with **PivotCache functionality level** (section [2.2.5.3.1](#)) greater than or equal to 3, the **fFilterInclusive** field of the **SXAddl_SXCField12_SXDVer12Info** record (section [2.4.273.33](#)) specifies whether new **pivot items** (section [2.2.5.4.4](#)) in the **source data** (section [2.2.5.3.2](#)) are shown or hidden by default when the **PivotTable report** (section [2.2.5](#)) is refreshed in addition to the **pivot items** (section [2.2.5.4.4](#)) that are already shown in the **PivotTable report** (section [2.2.5](#)) as the result of an applied **manual filter** (section [2.2.5.4.7](#)).

2.2.5.4.7.2 OLAP Manual Filters

For **OLAP PivotTable views** (section [2.2.5.4.2](#)), **manual filtering** (section [2.2.5.4.7](#)) operates on **pivot hierarchies** (section [2.2.5.4.5](#)). **OLAP manual filtering** uses filtering lists to determine what filtering to apply. The **OLAP manual filtering** operation depends on the **PivotCache Functionality Level** (section [2.2.5.3.1](#)) of the **associated PivotCache** (section [2.2.5.4.1](#)) of the **PivotTable view** (section [2.2.5.4](#)).

The list of excluded **OLAP members** is specified by the **rgHiddenMemberSets** field of the **SXTH record** (section [2.4.308](#)). If the **fFilterInclusive** field of the **SXTH record** (section 2.4.308) of the **pivot hierarchy** (section 2.2.5.4.5) is equal to 0x1, the list of excluded OLAP members MUST be empty.

The list of included OLAP members is specified by a collection of **SXAddl_SXCHierarchy_SXDFilterMember12 records** (section [2.4.273.45](#)) of the **pivot hierarchy** (section 2.2.5.4.5). If the **PivotCache Functionality Level** (section 2.2.5.3.1) of the **associated PivotCache** (section 2.2.5.4.1) of the **PivotTable view** (section 2.2.5.4) is less than 3, the selected **pivot items** (section [2.2.5.4.4](#)) list MUST be empty. If the **fFilterInclusive** field of the **SXTH record** (section 2.4.308) of the **pivot hierarchy** (section 2.2.5.4.5) is equal to 0x0, the list of included OLAP members MUST be empty.

The selected **pivot items** (section 2.2.5.4.4) list is specified to be the list of **pivot items** (section 2.2.5.4.4), with the **fOlapFilterSelected** field of the **SXVIFlags structure** (section [2.5.263](#)) that corresponds to each **pivot item** (section 2.2.5.4.4) equal to 0x1, in the **pivot fields** (section [2.2.5.4.3](#)) associated with the **pivot hierarchy** (section 2.2.5.4.5). If the **PivotCache Functionality Level** (section 2.2.5.3.1) of the **associated PivotCache** (section 2.2.5.4.1) of the **PivotTable view** (section 2.2.5.4) is less than 3, the selected **pivot items** (section 2.2.5.4.4) list MUST be empty.

If all of the lists of excluded OLAP members, included OLAP members and the selected **pivot items** (section 2.2.5.4.4) are empty, then no **manual filtering** (section 2.2.5.4.7) is specified for the **pivot hierarchy** (section 2.2.5.4.5). Otherwise, the value of the **fFilterInclusive** field of the **SXTH record** (section 2.4.308) of the **pivot hierarchy** (section 2.2.5.4.5) determines how the lists are used.

If the **fFilterInclusive** field of the **SXTH record** (section 2.4.308) of the **pivot hierarchy** (section 2.2.5.4.5) is equal to 0x1, the **members (2)** of the included OLAP members list and their ascendants and descendants are included in the **manual filter** (section 2.2.5.4.7). The **pivot items** (section 2.2.5.4.4) in the selected **pivot items** (section 2.2.5.4.4) list, and their ascendants and descendants are also included in the **manual filter** (section 2.2.5.4.7). New OLAP members in the **source data** (section [2.2.5.3.2](#)) will be excluded by default when the **PivotTable view** (section 2.2.5.4) is refreshed.

If the **fFilterInclusive** field of the **SXTH record** (section 2.4.308) of the **pivot hierarchy** (section 2.2.5.4.5) is equal to 0x0, the members (2) of the excluded OLAP members list and their descendants are excluded in the **manual filter** (section 2.2.5.4.7). The **pivot items** (section 2.2.5.4.4) in the selected **pivot items** (section 2.2.5.4.4) list and their descendants are also excluded in the **manual filter** (section 2.2.5.4.7). New OLAP members in the **source data** (section 2.2.5.3.2) will be included by default when the **PivotTable view** (section 2.2.5.4) is refreshed.

The filtering lists do not include OLAP members which are parent or child members of other OLAP members in the lists.

2.2.5.4.8 Filtering by Criteria

Filtering by criteria is the ability to conditionally show **pivot items** (section [2.2.5.4.4](#)) of **pivot fields** (section [2.2.5.4.3](#)) based on user-defined criteria. For example, a criteria **filter** might be defined to show all products that sold for more than \$30,000.

2.2.5.4.8.1 Advanced Filters

An **advanced filter** specifies a user-defined criterion that is used to determine the **pivot items** (section [2.2.5.4.4](#)) of a **pivot field** (section [2.2.5.4.3](#)) that are included when calculating values for

the **PivotTable view** (section [2.2.5.4](#)) and that are displayed in the **PivotTable report** (section [2.2.5](#)).

Only **advanced filters** that are associated with **pivot fields** (section 2.2.5.4.3) that are located on the **row axis** (section [2.2.5.4.9.2](#)) or the **column axis** (section [2.2.5.4.9.3](#)) are applied when the **PivotTable view** (section 2.2.5.4) is calculated.

An **advanced filter** is specified by the [SXCSXFilter12 class](#) section. The **isxvd** field of the **SXAddl_SXCSXFilter12_SXDSXFilter record** (section [2.4.273.82](#)) specifies the **pivot field** (section 2.2.5.4.3) associated with the **advanced filter**.

Advanced filters MUST NOT be applied to **pivot fields** (section 2.2.5.4.3) of a **PivotTable view** (section 2.2.5.4) if the **PivotCache functionality level** (section [2.2.5.3.1](#)) of the **associated PivotCache** (section [2.2.5.4.1](#)) is less than 3. **Advanced filters** MUST NOT be applied to an **OLAP PivotTable view** (section [2.2.5.4.2](#)) with a value of 0 for the **fSrvSupportSubquery** field of the **SXAddl_SXCCache_SXDInfo12 record** (section [2.4.273.7](#)) of the **associated PivotCache** (section 2.2.5.4.1).

There are three types of **advanced filters**: **label filter** (section [2.2.5.4.8.1.1](#)), **date filter** (section [2.2.5.4.8.1.2](#)), and **value filter** (section [2.2.5.4.8.1.3](#)).

A **pivot field** (section 2.2.5.4.3) MUST NOT have more than one associated **advanced filter** of the same type.

2.2.5.4.8.1.1 Label Filters

A **label filter** specifies a criterion that is applied to **pivot item** (section [2.2.5.4.4](#)) captions to determine which **pivot items** (section 2.2.5.4.4) are included in the calculation of values for the **PivotTable view** (section [2.2.5.4](#)) and displayed in the **PivotTable report** (section [2.2.5](#)).

A **label filter** is specified by an **SXAddl_SXCSXFilter12_SXDSXFilter record** (section [2.4.273.82](#)) with the **sxft** field equal to a value in the range 0x00000004 through 0x00000011.

Label filters are applied before any **value filters** (section [2.2.5.4.8.1.3](#)), but the order of **label filters** is not specified.

If a caption is specified, the **label filter** is applied to the **stName** field in the **SXVI records** (section [2.4.312](#)) associated with the **pivot items** (section 2.2.5.4.4). If captions are not specified for the **pivot items** (section 2.2.5.4.4), the **label filter** is applied to the values of the **cache items** (section [2.2.5.3.6](#)) associated with these **pivot items** (section 2.2.5.4.4).

A **label filter** can be applied to **member properties** (section [2.2.5.4.6](#)). The **isxvdMProp** field of the **SXAddl_SXCSXFilter12_SXDSXFilter record** (section 2.4.273.82) specifies the **member property** (section 2.2.5.4.6) on which this **label filter** is applied.

2.2.5.4.8.1.2 Date Filters

A **date filter** specifies a criterion that is applied to date type **pivot items** (section [2.2.5.4.4](#)) of a **pivot field** (section [2.2.5.4.3](#)). A **date filter** determines which **pivot items** (section 2.2.5.4.4) are included in the calculation of the **PivotTable view** (section [2.2.5.4](#)) and are displayed in the **PivotTable view** (section 2.2.5.4) report.

Date filters are specified by **SXAddl_SXCSXFilter12_SXDSXFilter records** (section [2.4.273.82](#)) with the **sxft** field in the range from 0x0000001A through 0x00000041.

For non-**OLAP PivotTable views** (section [2.2.5.4.2](#)), a **date filter** can be applied if and only if the **SXFDB record** (section [2.4.283](#)) associated with the corresponding **pivot field** (section 2.2.5.4.3) has the **fDateInField** field equal to 0x1, and the **fNonDates** field is equal to 0. For **OLAP PivotTable views** (section 2.2.5.4.2), a date filter can be applied if the **fTimeHierarchy** field of the **SXTH record** (section [2.4.308](#)) that specifies the **pivot hierarchy** (section [2.2.5.4.5](#)) is equal to 1.

Date filters are applied before **value filters** (section [2.2.5.4.8.1.3](#)) and in no specific order.

2.2.5.4.8.1.3 Value Filters

A **value filter** specifies a criterion that is applied to values of a **data item** (section [2.2.5.4.9.5.1](#)) for **pivot items** (section [2.2.5.4.4](#)) of the **pivot field** (section [2.2.5.4.3](#)) that the **value filter** is applied to. The **value filter** determines which **pivot items** (section [2.2.5.4.4](#)) are included when calculating values for the **PivotTable view** (section [2.2.5.4](#)) and displayed in the **PivotTable view** (section [2.2.5.4](#)) report.

A **value filter** is specified by the **SXAddl_SXCSXFilter12_SXDSXFilter** records (section [2.4.273.82](#)) with the **sf** field equal to a value in one of the following the ranges: from 0x00000001 through 0x00000003 or from 0x00000012 through 0x00000019.

Value filters are applied after **manual filters** (section [2.2.5.4.7](#)), **date filters** (section [2.2.5.4.8.1.2](#)) and **label filters** (section [2.2.5.4.8.1.1](#)) are applied. **Value filters** are applied in the order in which they are specified in the **SXCSXFilter12 class** section. **Value filtering** takes previous filtering into account when evaluating filters.

2.2.5.4.8.2 Simple Filters

A **simple filter** is a **top N filter** which is also known as **AutoShow**. The **fAutoShow** field of the **SXVDEx record** (section [2.4.310](#)) specifies whether a **simple filter** is applied for a **pivot field** (section [2.2.5.4.3](#)). The **fTopAutoShow** field of the **SXVDEx record** (section [2.4.310](#)) specifies whether a **simple filter** applies to the top or bottom *n* items. The **citmAutoShow** field of the **SXVDEx record** (section [2.4.310](#)) specifies the number of **pivot items** (section [2.2.5.4.4](#)) displayed.

Simple filters MUST only be applied to **pivot fields** (section [2.2.5.4.3](#)) of a **PivotTable view** (section [2.2.5.4](#)) with **data functionality level** (section [2.2.5.2](#)) less than or equal to 2, or to **pivot fields** (section [2.2.5.4.3](#)) of an **OLAP PivotTable views** (section [2.2.5.4.2](#)) with the **fSrvSupportSubquery** field of the **SXAddl_SXCCache_SXDInfo12 record** (section [2.4.273.7](#)) of the corresponding **PivotCache** (section [2.2.5.3](#)) equal to zero.

2.2.5.4.9 PivotTable Axes

A **PivotTable axis** is the set of **pivot fields** (section [2.2.5.4.3](#)) or **pivot hierarchies** (section [2.2.5.4.5](#)) in a **PivotTable view** (section [2.2.5.4](#)) used to populate an area of the **PivotTable report** (section [2.2.5](#)). The placement and positions of **pivot fields** (section [2.2.5.4.3](#)) on the axes are used to determine the **PivotTable Layout** (section [2.2.5.4.10](#)). The four axes of a **PivotTable view** (section [2.2.5.4](#)) are the **page axis** (section [2.2.5.4.9.1](#)), the **row axis** (section [2.2.5.4.9.2](#)), the **column axis** (section [2.2.5.4.9.3](#)), and the **data axis** (section [2.2.5.4.9.5](#)). For non-**OLAP PivotTable views** (section [2.2.5.4.2](#)), a **pivot field** (section [2.2.5.4.3](#)) MUST NOT appear more than once on the **PivotTable view** (section [2.2.5.4](#)), with the exception of the **data axis** (section [2.2.5.4.9.5](#)). For non-**OLAP PivotTable views** (section [2.2.5.4.2](#)), a **pivot field** (section [2.2.5.4.3](#)) can be placed one or more times on the **data axis** (section [2.2.5.4.9.5](#)) independently of whether it was placed on any other axis. For **OLAP PivotTable views** (section [2.2.5.4.2](#)), a **pivot field** (section [2.2.5.4.3](#)) MUST NOT be placed more than once on any axis. For both **OLAP** and non-**OLAP PivotTable views** (section [2.2.5.4.2](#)), **pivot fields** (section [2.2.5.4.3](#)) do not have to be placed on any **PivotTable axis**.

2.2.5.4.9.1 Page Axis

The **page axis** contains the **pivot fields** (section [2.2.5.4.3](#)) or **pivot hierarchies** (section [2.2.5.4.5](#)) that populate the **page area** (section [2.2.5.4.10.1.3](#)) of the **PivotTable report** (section [2.2.5](#)), as specified by **PivotTable Layout** (section [2.2.5.4.10](#)), and that are intended for use as **filters**. These **pivot fields** (section [2.2.5.4.3](#)) and **pivot hierarchies** (section [2.2.5.4.5](#)) do not affect the layout of the other areas of the **PivotTable report** (section [2.2.5](#)), but rather filter the data used by the entire **PivotTable view** (section [2.2.5.4.2](#)).

The **page axis** is specified by the sequence of records that conform to the **PIVOTPI rule** (section [2.1.7.20.5](#)) and optionally by the collection of **SXPIEx records** (section [2.4.299](#)) in the sequence of records that conform to the **PIVOTVIEWEX rule** (section [2.1.7.20.5](#)). For non-**OLAP PivotTable views** (section [2.2.5.4.2](#)), the **SXPI_Item structure** (section [2.5.260](#)) specified by each array element of the **rgsxpi** field of the **SXPI record** (section [2.4.298](#)) specifies one **pivot field** (section [2.2.5.4.3](#)) on the page axis. For **OLAP PivotTable views** (section [2.2.5.4.2](#)), each **SXPIEx record** (section [2.4.299](#)) specifies one **pivot hierarchy** (section [2.2.5.4.5](#)) on the **page axis**. The order of the **pivot fields** (section [2.2.5.4.3](#)) and **pivot hierarchies** (section [2.2.5.4.5](#)) in these collections for the non-**OLAP** and **OLAP** cases specifies the order in which the **pivot fields** (section [2.2.5.4.3](#)) and **pivot hierarchies** (section [2.2.5.4.5](#)) appear on the **page axis**.

For non-**OLAP PivotTable views** (section [2.2.5.4.2](#)), the **isxvd** field of the **SXPI_Item structure** (section [2.5.260](#)) specifies the associated **pivot field** (section [2.2.5.4.3](#)). For **OLAP PivotTable views** (section [2.2.5.4.2](#)), the **isxth** field of the **SXPIEx record** (section [2.4.299](#)) specifies the associated **pivot hierarchy** (section [2.2.5.4.5](#)).

2.2.5.4.9.1.1 Non-OLAP Page Filtering

A non-**OLAP PivotTable view** (section [2.2.5.4.2](#)) can be filtered to not include some **pivot items** (section [2.2.5.4.4](#)) from the **pivot fields** (section [2.2.5.4.3](#)) on the **page axis** (section [2.2.5.4.9.1](#)). The **PivotTable report** (section [2.2.5](#)) only includes values specified by **cache items** (section [2.2.5.3.6](#)) that are associated with **pivot items** (section [2.2.5.4.4](#)) that are filtered in.

The following table specifies how the filtering of **pivot items** (section [2.2.5.4.4](#)) of a **pivot field** (section [2.2.5.4.3](#)) is specified.

In the following table, the first column is the value of the **rgsxpi.isxvi** field of the **SXPI record** (section [2.4.298](#)), and the second column is the value of the **fSubtotalHiddenPageItems** field of the **SXEx record** (section [2.4.282](#)).

Value of rgsxpi.isxvi	Value of fSubtotalHiddenPageItems	Filtering Behavior
Not 0x7FFD	Any	Specifies that the rgsxpi.isxvi field of the SXPI record (section 2.4.298) specifies a pivot item (section 2.2.5.4.4) index, as specified by the Pivot Items section, of the one pivot item (section 2.2.5.4.4) of a pivot field (section 2.2.5.4.3) that is filtered in.
0x7FFD	0	Specifies that pivot items (section 2.2.5.4.4) are filtered in if and only if the fHidden field of the corresponding SXVI records (section 2.4.312) is equal to 0. However, all pivot items (section 2.2.5.4.4) are factored into the subtotal.
0x7FFD	1	Specifies that pivot items (section 2.2.5.4.4) are filtered in if and only if the fHidden field of the corresponding SXVI records (section 2.4.312) is equal to zero. Only pivot items (section 2.2.5.4.4) that are filtered in are factored into the subtotal.

2.2.5.4.9.1.2 OLAP Page Filtering

In an **OLAP PivotTable views** (section [2.2.5.4.2](#)) the filtering on the **page axis** (section [2.2.5.4.9.1](#)) is specified using the **pivot hierarchy** (section [2.2.5.4.5](#)) that the **pivot field** (section [2.2.5.4.3](#)) is associated with, as specified in the [Association of Pivot Hierarchies and Pivot Fields and Cache Fields](#) section.

If the value of the **fEnableMultiplePageItems** field of the **SXTH record** (section [2.4.308](#)) of the **pivot hierarchy** (section [2.2.5.4.5](#)) is 0, the **stUnique** field of the **SXPIEx record** (section [2.4.299](#)) specifies an **OLAP member** to filter by.

If the value of the **fEnableMultiplePageItems** field of the **SXTH record** (section 2.4.308) of the **pivot hierarchy** (section 2.2.5.4.5) is 1, then the specification depends on the **PivotCache Functionality Level** (section 2.2.5.3.1) of the **associated PivotCache** (section 2.2.5.4.1) of the **PivotTable view** (section 2.2.5.4), as specified in the following table:

PivotCache Functionality Level	Filtering Behavior
Less than 3	Specifies that the SXAddl_SXCHierarchy_SXDFilterMember records (section 2.4.273.44) of the pivot hierarchy (section 2.2.5.4.5) specify the OLAP members to filter by.
Greater than or equal to 3	Specifies that the filtering is applied as specified by Manual Filters (section 2.2.5.4.7) and OLAP Manual Filters (section 2.2.5.4.7.2) for this pivot hierarchy (section 2.2.5.4.5).

2.2.5.4.9.2 Row Axis

The **row axis** contains the **pivot fields** (section 2.2.5.4.3) and an optional **data field** (section 2.2.5.4.9.5.2) used to populate the **row area** (section 2.2.5.4.10.1.1) of the **PivotTable report** (section 2.2.5), as specified by the **PivotTable Layout** section.

The **pivot fields** (section 2.2.5.4.3) on the **row axis** are specified by the first **SxIvd record** (section 2.4.292) in the sequence of records that conform to the **PIVOTCORE rule** (section 2.1.7.20.5) as defined by the Worksheet Substream **ABNF**, which specifies an array of **SxIvdRw structures** (section 2.5.258). The order that the **pivot fields** (section 2.2.5.4.3) and the optional **data field** (section 2.2.5.4.9.5.2) are referenced from the **SxIvd record** (section 2.4.292) specifies the order that the **pivot fields** (section 2.2.5.4.3) and the optional **data field** (section 2.2.5.4.9.5.2) display on the row axis. The order that the **pivot fields** (section 2.2.5.4.3) and the optional **data field** (section 2.2.5.4.9.5.2) display on the row axis corresponds to the order that the **pivot fields** (section 2.2.5.4.3) and the optional **data field** (section 2.2.5.4.9.5.2) are placed in the **row area** (section 2.2.5.4.10.1.1) of the **PivotTable report** (section 2.2.5).

For adjacent **SxIvdRw structures** (section 2.5.258) in the **rgSxIvd** field of the **SxIvd record** (section 2.4.292), the **pivot field** (section 2.2.5.4.3) or **data field** (section 2.2.5.4.9.5.2) that the first **SxIvdRw references** (section 2.5.258) is defined to be an outer field with respect to the **pivot field** (section 2.2.5.4.3) or the **data field** (section 2.2.5.4.9.5.2) that the second **SxIvdRw references** (section 2.5.258). The **pivot field** (section 2.2.5.4.3) or **data field** (section 2.2.5.4.9.5.2) that the second **SxIvdRw references** (section 2.5.258) is defined to be an inner field with respect to the **pivot field** (section 2.2.5.4.3) or the **data field** (section 2.2.5.4.9.5.2) that the first **SxIvdRw references** (section 2.5.258).

For **OLAP PivotTables** (section 2.2.5), all **SxIvdRw records** (section 2.5.258) in the **rgSxIvd** field of the **SxIvd record** (section 2.4.292) that reference **pivot fields** (section 2.2.5.4.3) that are associated with the same **pivot hierarchy** (section 2.2.5.4.5) MUST be adjacent. **Pivot fields** (section 2.2.5.4.3) associated with **member properties** (section 2.2.5.4.6) of the **pivot hierarchy** (section 2.2.5.4.5) MUST be located on the row axis after other types of **pivot fields** (section 2.2.5.4.3) associated with the same **pivot hierarchy** (section 2.2.5.4.5). **Pivot fields** (section 2.2.5.4.3) not associated with **member properties** (section 2.2.5.4.6) of the **pivot hierarchy** (section 2.2.5.4.5) MUST appear on the row axis in an order such that the zero-based ordinal of the **OLAP level** of each **pivot field** (section 2.2.5.4.3) associated with the same **pivot hierarchy** (section 2.2.5.4.5) is ascending. The zero-based ordinal of the OLAP level of a **pivot field** (section 2.2.5.4.3) is specified by the **isxtl** field of the **SXVDTE record** (section 2.4.311).

For OLAP **PivotTables** (section 2.2.5), the **SXTH record** (section 2.4.308) specifies information about a **pivot hierarchy** (section 2.2.5.4.5), including which axis the **pivot hierarchy** (section 2.2.5.4.5) is on.

See the **Nesting** section for more information.

2.2.5.4.9.3 Column Axis

The column axis contains the **pivot fields** (section [2.2.5.4.3](#)) and an optional **data field** (section [2.2.5.4.9.5.2](#)) used to populate the **column area** (section [2.2.5.4.10.1.2](#)) of the **PivotTable report** (section [2.2.5](#)), as specified by the [PivotTable Layout](#) section.

The **pivot fields** (section 2.2.5.4.3) on the row axis are specified by the second **SxIvd record** (section [2.4.292](#)) in the sequence of records that conform to the **PIVOTCORE rule** (section [2.1.7.20.5](#)) as defined by the Worksheet Substream **ABNF**, which specifies an array of **SxIvdCol structures** (section [2.5.257](#)).

The order that the **pivot fields** (section 2.2.5.4.3) and the optional **data field** (section 2.2.5.4.9.5.2) are referenced from the **SxIvd record** (section 2.4.292) specifies the order that the **pivot fields** (section 2.2.5.4.3) and the optional **data field** (section 2.2.5.4.9.5.2) display on the column axis. The order that the **pivot fields** (section 2.2.5.4.3) and the optional **data field** (section 2.2.5.4.9.5.2) display on the column axis corresponds to the order that the **pivot fields** (section 2.2.5.4.3) and the optional **data field** (section 2.2.5.4.9.5.2) are placed in the **column area** (section 2.2.5.4.10.1.2) of the **PivotTable report** (section 2.2.5).

For adjacent **SxIvdCol structures** (section 2.5.257) in the **rgSxIvd** field of the **SxIvd record** (section 2.4.292), the **pivot field** (section 2.2.5.4.3) or **data field** (section 2.2.5.4.9.5.2) that the first **SxIvdCol references** (section 2.5.257) is defined to be an outer field with respect to the **pivot field** (section 2.2.5.4.3) or the **data field** (section 2.2.5.4.9.5.2) that the second **SxIvdCol references** (section 2.5.257). The **pivot field** (section 2.2.5.4.3) or **data field** (section 2.2.5.4.9.5.2) that the second **SxIvdCol references** (section 2.5.257) is defined to be an inner field with respect to the **pivot field** (section 2.2.5.4.3) or the **data field** (section 2.2.5.4.9.5.2) that the first **SxIvdCol references** (section 2.5.257).

For **OLAP PivotTables** (section 2.2.5), all **SxIvdCol structures** (section 2.5.257) in the **rgSxIvd** field of the **SxIvd record** (section 2.4.292) that reference **pivot fields** (section 2.2.5.4.3) that are associated with the same **pivot hierarchy** (section [2.2.5.4.5](#)) MUST be adjacent. **Pivot fields** (section 2.2.5.4.3) associated with **member properties** (section [2.2.5.4.6](#)) of the **pivot hierarchy** (section 2.2.5.4.5) MUST be located on the column axis after other types of **pivot fields** (section 2.2.5.4.3) associated with the same **pivot hierarchy** (section 2.2.5.4.5). **Pivot fields** (section 2.2.5.4.3) not associated with **member properties** (section 2.2.5.4.6) of the **pivot hierarchy** (section 2.2.5.4.5) MUST appear on the column axis in an order such that the zero-based ordinal of the **OLAP level** of each **pivot field** (section 2.2.5.4.3) associated with the same **pivot hierarchy** (section 2.2.5.4.5) is ascending. The zero-based ordinal of the OLAP level of a **pivot field** (section 2.2.5.4.3) is specified by the **isxtl** field of the **SXVDTEX record** (section [2.4.311](#)).

For OLAP **PivotTables** (section 2.2.5), the **SXTH record** (section [2.4.308](#)) specifies information about a **pivot hierarchy** (section 2.2.5.4.5), including which axis the **pivot hierarchy** (section 2.2.5.4.5) is on.

See the [Nesting](#) section for more information.

2.2.5.4.9.4 Nesting

This section applies to both the **row axis** (section [2.2.5.4.9.2](#)) and **column axis** (section [2.2.5.4.9.3](#)) unless otherwise specified. Within this section, axis means the **row axis** (section 2.2.5.4.9.2) or the **column axis** (section 2.2.5.4.9.3) as appropriate; fields means **pivot fields** (section [2.2.5.4.3](#)), the **data field** (section [2.2.5.4.9.5.2](#)), or both on the axis; area means the in **row area** (section [2.2.5.4.10.1.1](#)) and **column area** (section [2.2.5.4.10.1.2](#)) as appropriate; items means **pivot items** (section [2.2.5.4.4](#)) or **data items** (section [2.2.5.4.9.5.1](#)) as appropriate.

The axes specify an order that the fields are represented in the areas, see the [PivotTable layout](#) section for more information about the areas. **Pivot lines** (section [2.2.5.4.10.3](#)) within the areas have references to items. Usually a **pivot line** (section 2.2.5.4.10.3) including an item of an outer field only includes items in the inner fields that exist with the item of the outer field in the **source data** (section

[2.2.5.3.2](#)), subject to the filtering on the PivotTable view. Usually all the instances of an item in the area are grouped together, with grouping on the outer fields taking precedence over grouping on the inner fields. This process is called **nesting**.

A nested item group is specified to be the contiguous set of **pivot lines** (section 2.2.5.4.10.3) that have the same item in an outer field.

The following example shows nested item groups for Country, State and City.

Country	State	City
USA	Illinois	Chicago
USA	Illinois	Springfield
USA	Louisiana	New Orleans
USA	Louisiana	Baton Rouge
Mexico	Jalisco	Guadalajara

The first two lines are a nested item group for Illinois. The next two lines are a nested item group for Louisiana. The first four lines are a nested item group for USA. The last line is both a nested item group for Jalisco and Mexico. Note that often in a **PivotTable report** (section [2.2.5](#)) the repeated item labels will be omitted.

For an **OLAP PivotTable view** (section 2.2.5.4.2), nesting can be the result of either:

- Items in the inner field that are in a different **pivot hierarchy** (section [2.2.5.4.5](#)), or,
- Items in an inner pivot field that is associated with the same **pivot hierarchy** (section 2.2.5.4.5) and that are child OLAP members.

2.2.5.4.9.4.1 Collapsing

Settings in the file format can specify that a **pivot item** (section [2.2.5.4.4](#)) of an outer **pivot field** (section [2.2.5.4.3](#)), rather than having inner nested **pivot items** (section 2.2.5.4.4) of inner **pivot fields** (section 2.2.5.4.3), is collapsed. Usually when a **pivot item** (section 2.2.5.4.4) on an outer **pivot field** (section 2.2.5.4.3) is collapsed, it does not have a nested **pivot item** (section 2.2.5.4.4) group and when it appears in a **pivot line** (section [2.2.5.4.10.3](#)), the **pivot items** (section 2.2.5.4.4) of the inner **pivot fields** (section 2.2.5.4.3) for the collapsed **pivot item** (section 2.2.5.4.4) do not appear in the **pivot line** (section 2.2.5.4.10.3).

If Illinois and Mexico were collapsed in the preceding table, the result might look like the following table.

Country	State	City
USA	Illinois	
USA	Louisiana	New Orleans
USA	Louisiana	Baton Rouge
Mexico		

For a non-**OLAP PivotTable view** (section [2.2.5.4.2](#)), the collapsed state is specified by the **fHideDetail** field of the **SXVI record** (section [2.4.312](#)).

For an **OLAP PivotTable views**(section 2.2.5.4.2), there are two types of collapsing: child **collapsing** and **attribute hierarchy collapsing**.

Child **collapsing** is when the child **pivot items** (section 2.2.5.4.4), corresponding to child **OLAP members**, of a **pivot item** (section 2.2.5.4.4) corresponding to a parent OLAP member in an **OLAP hierarchy** are not shown.

If a **pivot field** (section 2.2.5.4.3) is the first **pivot field** (section 2.2.5.4.3) of the **pivot hierarchy** (section 2.2.5.4.5) on the axis then the **fDrilledLevel** field of the **SXVDTE record** (section 2.4.311) **pivot field** (section 2.2.5.4.3) MUST be 1.

If a **pivot field** (section 2.2.5.4.3) is not the first **pivot field** (section 2.2.5.4.3) of the **pivot hierarchy** (section 2.2.5.4.5) on the axis and if the **fDrilledLevel** field of the **SXVDTE record** (section 2.4.311) of the **pivot field** (section 2.2.5.4.3) is 1, then there is no child collapsing for the preceding **pivot field** (section 2.2.5.4.3) of the **pivot hierarchy** (section 2.2.5.4.5) on the axis and the **fDrilledMember** field of the **SXVIFlags structure** (section 2.5.263) for the **pivot items** (section 2.2.5.4.4) of the preceding **pivot field** (section 2.2.5.4.3) of the **pivot hierarchy** (section 2.2.5.4.5) on the axis MUST be 0. If a **pivot field** (section 2.2.5.4.3) is followed by another **pivot field** (section 2.2.5.4.3) of the same **pivot hierarchy** (section 2.2.5.4.5) on the axis, and the **fDrilledLevel** field of the **SXVDTE record** (section 2.4.311) of the inner **pivot field** (section 2.2.5.4.3) is equal to 0 and the **fDrilledMember** field of the **SXVIFlags structure** (section 2.5.263) of the **pivot item** (section 2.2.5.4.4) of the outer **pivot field** (section 2.2.5.4.3) is 0, then the **pivot item** (section 2.2.5.4.4) associated with the **SXVIFlags structure** (section 2.5.263) is collapsed using child **collapsing**.

Attribute hierarchy **collapsing** only occurs when a **pivot field** (section 2.2.5.4.3) is associated with a **pivot hierarchy** (section 2.2.5.4.5) that is an attribute hierarchy and the **pivot field** (section 2.2.5.4.3) immediately following that outer **pivot field** (section 2.2.5.4.3) is associated with a different **pivot hierarchy** (section 2.2.5.4.5) that is an attribute hierarchy. In that case, if a **pivot item** (section 2.2.5.4.4) is attribute hierarchy collapsed, **pivot items** (section 2.2.5.4.4), corresponding to OLAP members, will not be shown for the inner **pivot field** (section 2.2.5.4.3). The attribute hierarchy collapsed state of a **pivot item** (section 2.2.5.4.4) is specified by the **fCollapsedMember** flag of the **SXVIFlags structure** (section 2.5.263). The **fItemsDrilledByDefault** flag of the **SXVDTE record** (section 2.4.311) provides a default value for **pivot items** (section 2.2.5.4.4) in the **pivot field** (section 2.2.5.4.3).

For an **OLAP PivotTable view** (section 2.2.5.4.2), there can be **pivot items** (section 2.2.5.4.4) for an inner **pivot field** (section 2.2.5.4.3) on the **pivot line** (section 2.2.5.4.10.3) if either the outer **pivot field** (section 2.2.5.4.3) is collapsed and the inner **pivot field** (section 2.2.5.4.3) and outer **pivot field** (section 2.2.5.4.3) are in different **pivot hierarchies** (section 2.2.5.4.5) and attribute hierarchy **collapsing** is not being used or if the **pivot items** (section 2.2.5.4.4) are **member properties** (section 2.2.5.4.6).

2.2.5.4.9.4.2 Subtotalling

A nested item group, as specified in the [Nesting](#) section, can have summaries of the values for the items in the nested item group, called subtotals. A subtotal is typically an aggregation such as a sum, count or average of the values of the items.

The creation of subtotals is specified by the **fDefault**, **fSum**, **fCounta**, **fAverage**, **fMax**, **fMin**, **fProduct**, **fCount**, **fStdev**, **fStdevp**, **fVariance** and **fVariancep** fields of the **Sxvd record** (section 2.4.309) of the **pivot field** (section 2.2.5.4.3). If none of the fields are equal to 1, then no subtotals exist for the **pivot field** (section 2.2.5.4.3). If the **fDefault** field is equal to 1 the subtotal calculation for each item is done according to the **aggregation functions** of the **data items** (section 2.2.5.4.9.5.1) on the **data axis** (section 2.2.5.4.9.5), as specified by the **iiftab** field of the **SXDI record** (section 2.4.278) for each **data item** (section 2.2.5.4.9.5.1).

For example, the subtotal is calculated as the sum of the relevant values of the nested item group for a **data item** (section 2.2.5.4.9.5.1) with a sum aggregation function and subtotal is calculated as the average of the relevant values of the nested item group for a **data item** (section 2.2.5.4.9.5.1) with an average aggregation function.

The other subtotal fields are called custom subtotals because they override the **data item** (section 2.2.5.4.9.5.1) aggregation function when calculating subtotals.

In some cases, such as for certain **OLAP PivotTable views** (section 2.2.5.4.2), the **source data** (section 2.2.5.3.2) is not able to provide a requested subtotal.

The **fOutline** field of the **SXVDEx record** (section 2.4.310) specifies that an extra **pivot line** (section 2.2.5.4.10.3) is added at the logical top of the nested item groups if the **pivot field** (section 2.2.5.4.3) is on the **row axis** (section 2.2.5.4.9.2). This **pivot line** (section 2.2.5.4.10.3) contains the item and any items of **member properties** (section 2.2.5.4.6) **pivot fields** (section 2.2.5.4.3), if they are shown, but no other items for inner **pivot fields** (section 2.2.5.4.3) of this **pivot field** (section 2.2.5.4.3).

The **fOutlineData** field of the **SXAddl_SXCView_SXDVer12Info record** (section 2.4.273.109) specifies that an extra **pivot line** (section 2.2.5.4.10.3) is added at the logical top of the nested item groups if the **data field** (section 2.2.5.4.9.5.2) is on the **row axis** (section 2.2.5.4.9.2). This **pivot line** (section 2.2.5.4.10.3) contains the **data item** (section 2.2.5.4.9.5.1), but no other items for inner **pivot fields** (section 2.2.5.4.3) of this **data field** (section 2.2.5.4.9.5.2).

If the **fDefault** field of the **Sxvd record** (section 2.4.309) of the **pivot field** (section 2.2.5.4.3) is equal to 1, the **fOutline** field of the **SXVDEx record** (section 2.4.310) of the **pivot field** (section 2.2.5.4.3) is equal to 1, the **pivot field** (section 2.2.5.4.3) is on the **row axis** (section 2.2.5.4.9.2), and the **data field** (section 2.2.5.4.9.5.2) is not placed inner of the **pivot field** (section 2.2.5.4.3) on the **row axis** (section 2.2.5.4.9.2), then the following is specified for the **fSubtotalAtTop** field of the **SXVDEx record** (section 2.4.310) of the **pivot field** (section 2.2.5.4.3):

Value of fSubtotalAtTop	Meaning
0x0	Specifies that subtotal pivot lines (section 2.2.5.4.10.3) are added at the bottom of the nested item groups. See the subName.stSubName field of the SXVDEx record (section 2.4.310) for details of the label used.
0x1	Specifies that the pivot lines (section 2.2.5.4.10.3) added as specified by the fOutline flag of the SXVDEx record (section 2.4.310) being equal to 1 are used for displaying the subtotals in the data area (section 2.2.5.4.10.1.4).

In the following figure, the Category, Subcategory, and Product columns represent **pivot fields** (section 2.2.5.4.3) on the **row axis** (section 2.2.5.4.9.2) and the Color column represents a **member properties** (section 2.2.5.4.6) **pivot field** (section 2.2.5.4.3) associated with the Product **pivot field** (section 2.2.5.4.3). Subtotals are displayed at the logical top of the nested item groups for Clothing, Caps, and Gloves.

Category	Subcategory	Product	Color	Internet Sales Amount
Clothing				\$54,708.80
	Caps			\$19,688.10
		AWC Logo Cap	Multi	\$19,688.10
	Gloves			\$35,020.70
		Half-Finger Gloves, S	Black	\$11,951.12
		Half-Finger Gloves, M	Black	\$12,220.51
		Half-Finger Gloves, L	Black	\$10,849.07
Grand Total				\$54,708.80

Figure 14: PivotTable report with Category and Subcategory pivot fields with fOutline and fSubtotalAtTop fields of the SXVDEx record equal to 1

2.2.5.4.9.5 Data Axis

The **data axis** contains the **pivot field** (section [2.2.5.4.3](#)) values that are used to populate the **data area** (section [2.2.5.4.10.1.4](#)) of the **PivotTable report** (section [2.2.5](#)) as specified by the **PivotTable Layout** section. The **data axis** also specifies additional information related to summarizing and presenting the values as specified by the **Data Items** section. The **data axis** is specified by the collection of **SXDI records** (section [2.4.278](#)) that conform to the **PIVOTCORE rule** (section [2.1.7.20.5](#)) as defined by the Worksheet Substream **ABNF**.

2.2.5.4.9.5.1 Data Items

A **data item** is a **pivot field** (section [2.2.5.4.3](#)) placed on the **data axis** (section [2.2.5.4.9.5](#)). Each **data item** is specified by an **SXDI record** (section [2.4.278](#)).

The **isxvdData** field of the **SXDI record** (section [2.4.278](#)) specifies a reference to the **pivot field** (section [2.2.5.4.3](#)) that is associated with a **data item**. It also specifies additional information that is used to produce or present summarized values.

A **data item** can be referenced by a data item index, which is the zero-based index of an **SXDI record** (section [2.4.278](#)) in the sequence of records that conforms to the **PIVOTCORE rule** (section [2.1.7.20.5](#)) as defined by the Worksheet Substream **ABNF**.

2.2.5.4.9.5.2 Data Field

The **data field** is a conceptual field that represents all **data items** (section [2.2.5.4.9.5.1](#)) and enables them to be referenced as a single object. The **data field** is intended to enable all **data items** (section [2.2.5.4.9.5.1](#)) to be placed on the **row axis** (section [2.2.5.4.9.2](#)) or **column axis** (section [2.2.5.4.9.3](#)).

If the **PivotTable view** (section [2.2.5.4](#)) has more than one **data item** (section [2.2.5.4.9.5.1](#)), then the **data field** MUST be located on either the **row axis** (section [2.2.5.4.9.2](#)) as specified by the **rgSxivd** field of the first **Sxivd record** (section [2.4.292](#)), or the **column axis** (section [2.2.5.4.9.3](#)) as specified by the **rgSxivd** field of the second **Sxivd record** (section [2.4.292](#)).

2.2.5.4.10 PivotTable Layout

The **PivotTable report** (section [2.2.5](#)) in the **sheet (2)** has four main areas: the **row area** (section [2.2.5.4.10.1.1](#)), the **column area** (section [2.2.5.4.10.1.2](#)), the **data area** (section [2.2.5.4.10.1.4](#)), and the **page area** (section [2.2.5.4.10.1.3](#)).

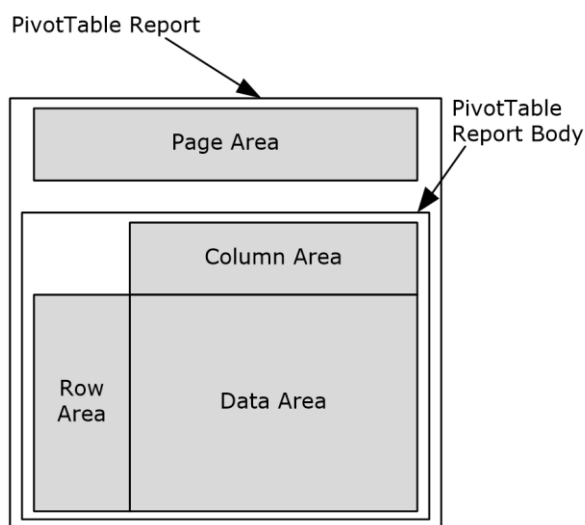

Figure 15: PivotTable report illustrating the four different areas

All the records described here MUST exist in the same **worksheet substream** (section [2.1.7.20.5](#)).

2.2.5.4.10.1 Location and Body

The **column area** (section [2.2.5.4.10.1.2](#)) is located immediately above the **data area** (section [2.2.5.4.10.1.4](#)). The **cell** in the **column area** (section 2.2.5.4.10.1.2) containing the **pivot item** (section [2.2.5.4.4](#)) **caption** or **data item** (section [2.2.5.4.9.5.1](#)) caption to the farthest **logical left** is in the same column as the **logical top-left** cell of the **data area** (section 2.2.5.4.10.1.4).

The **row area** (section [2.2.5.4.10.1.1](#)) is located immediately to the logical left of the **data area** (section 2.2.5.4.10.1.4). The cell in the **row area** (section 2.2.5.4.10.1.1) containing the top-most **pivot item** (section 2.2.5.4.4) caption or **data item** (section 2.2.5.4.9.5.1) caption is in the same row as the logical top-left cell of the **data area** (section 2.2.5.4.10.1.4).

The **PivotTable report** (section [2.2.5](#)) body is the rectangular area defined by the union of the **row area** (section 2.2.5.4.10.1.1), **column area** (section 2.2.5.4.10.1.2), and **data area** (section 2.2.5.4.10.1.4).

The **page area** (section [2.2.5.4.10.1.3](#)), if it is not empty, is located above the **PivotTable report** (section 2.2.5) body. There is one row between the top-most cell of the **PivotTable report** (section 2.2.5) body and the bottom-most cell of the **page area** (section 2.2.5.4.10.1.3).

The **PivotTable report** (section 2.2.5) is a **non-contiguous range** containing the union of the **PivotTable report** (section 2.2.5) body and the **page area** (section 2.2.5.4.10.1.3).

An **SxView** record and the **SXEx record** (section [2.4.282](#)) specify details about the location of the **PivotTable report** (section 2.2.5) in the **sheet** and the sizes of the areas of the **PivotTable report** (section 2.2.5) as specified by the following. All fields are of the **SxView record** (section 2.4.313) unless otherwise specified.

The **column area** (section 2.2.5.4.10.1.2) of the **PivotTable report** (section 2.2.5) is specified to be the following range of cells:

Column Area	Row or Column Index
Top row	ref.rwFirst
Bottom row	rwFirstData - 1
Logical left column	colFirstData
Logical right column	ref.colLast

If **colFirstData** is greater than **ref.colLast**, the **column area** (section 2.2.5.4.10.1.2) does not exist for this **PivotTable report** (section 2.2.5).

The **row area** (section 2.2.5.4.10.1.1) of the **PivotTable report** (section 2.2.5) is specified to be the following range of cells:

Row Area	Row or Column Index
Top row	rwFirstData
Bottom row	ref.rwLast
Logical left column	ref.colFirst

Row Area	Row or Column Index
Logical right column	colFirstData - 1

If **colFirstData** - 1 is less than **ref.colFirst**, the **row area** (section 2.2.5.4.10.1.1) does not exist for this **PivotTable report** (section 2.2.5).

The **data area** (section 2.2.5.4.10.1.4) of the **PivotTable report** (section 2.2.5) is specified to be the following range of cells:

Data Area	Row or Column Index
Top row	rwFirstData
Bottom row	ref.rwLast
Logical left column	colFirstData
Logical right column	ref.colLast

If the **row area** (section 2.2.5.4.10.1.1) or the **column area** (section 2.2.5.4.10.1.2) does not exist for this **PivotTable report** (section 2.2.5), the **data area** (section 2.2.5.4.10.1.4) does not exist for this **PivotTable report** (section 2.2.5).

The **page area** (section 2.2.5.4.10.1.3) of the **PivotTable report** (section 2.2.5) is specified to be the following range of cells. The **cRwPage** field and the **cColPage** field are of the **SXEx record** (section 2.4.282):

Page Area	Row or Column Index
Top row	ref.rwFirst - cRwPage - 1
Bottom row	ref.rwFirst - 2
Logical left column	ref.colFirst
Logical right column	ref.colFirst + cColPage - 1

If the **cRwPage** field of the **SXEx record** (section 2.4.282) is equal to 0 and the **fNewDropZones** field of the **SXAddl_SXCView_SXDVer12Info record** (section [2.4.273.109](#)) is equal to 1 the **page area** (section 2.2.5.4.10.1.3) does not exist for this **PivotTable report** (section 2.2.5).

If the **cRwPage** field is equal to 0 and the **fNewDropZones** field is equal to 0, then the **page area** (section 2.2.5.4.10.1.3) of the **PivotTable report** (section 2.2.5) is specified to be the following **range** of cells:

Page Area	Row or Column Index
Top row	ref.rwFirst - 2
Bottom row	ref.rwFirst - 2
Logical left column	ref.colFirst

Page Area	Row or Column Index
Logical right column	ref.colLast

2.2.5.4.10.1.1 Row Area

The **row area** contains **pivot fields** (section [2.2.5.4.3](#)), the optional **data field** (section [2.2.5.4.9.5.2](#)), or both that are placed on the **row axis** (section [2.2.5.4.9.2](#)), along with associated **pivot items** (section [2.2.5.4.4](#)) and **data items** (section [2.2.5.4.9.5.1](#)). The first row of the **row area** can contain **pivot field** (section [2.2.5.4.3](#)) captions, **data field** (section [2.2.5.4.9.5.2](#)) captions, or both as specified by the **fNoHeaders** field of the **SXAddl_SXCView_SXDVer12Info record** (section [2.4.273.109](#)). If the **fNoHeaders** field of the **SXAddl_SXCView_SXDVer12Info record** (section [2.4.273.109](#)) is equal to 0 or the **SXAddl_SXCView_SXDVer12Info record** (section [2.4.273.109](#)) is not present, the **pivot field** (section [2.2.5.4.3](#)) and **data field** (section [2.2.5.4.9.5.2](#)) captions are located above their **pivot items** (section [2.2.5.4.4](#)) or **data items** (section [2.2.5.4.9.5.1](#)).

Pivot items (section [2.2.5.4.4](#)) or **data items** (section [2.2.5.4.9.5.1](#)) of the **pivot field** (section [2.2.5.4.3](#)) or **data field** (section [2.2.5.4.9.5.2](#)) that has a position of 0 on the **row axis** (section [2.2.5.4.9.2](#)) are placed in the first column of the **row area**. For every other **pivot field** (section [2.2.5.4.3](#)) or **data field** (section [2.2.5.4.9.5.2](#)) on the **row axis** (section [2.2.5.4.9.2](#)), placement of **pivot items** (section [2.2.5.4.4](#)) or **data items** (section [2.2.5.4.9.5.1](#)) are calculated as follows:

- If the previous **pivot field** (section [2.2.5.4.3](#)) or **data field** (section [2.2.5.4.9.5.2](#)) is not in **compact axis** mode, then **pivot items** (section [2.2.5.4.4](#)) or **data items** (section [2.2.5.4.9.5.1](#)) of the current **pivot field** (section [2.2.5.4.3](#)) or **data field** (section [2.2.5.4.9.5.2](#)) are placed in the next column of the **row area**. **Pivot items** (section [2.2.5.4.4](#)) or **data items** (section [2.2.5.4.9.5.1](#)) are grouped by the parent **pivot item** (section [2.2.5.4.4](#)) or **data item** (section [2.2.5.4.9.5.1](#)), which is the **pivot item** (section [2.2.5.4.4](#)) or **data item** (section [2.2.5.4.9.5.1](#)) on the immediate **logical left**. To achieve this, **pivot items** (section [2.2.5.4.4](#)) or **data items** (section [2.2.5.4.9.5.1](#)) of the parent **pivot field** (section [2.2.5.4.3](#)) or **data field** (section [2.2.5.4.9.5.2](#)) can be repeated multiple times. In this case, when **pivot items** (section [2.2.5.4.4](#)) or **data items** (section [2.2.5.4.9.5.1](#)) are repeated, the caption is not necessarily displayed in every **cell** that contains a **pivot item** (section [2.2.5.4.4](#)) or **data item** (section [2.2.5.4.9.5.1](#)). For more details, see the [Pivot Lines](#) section.
- If the previous **pivot field** (section [2.2.5.4.3](#)) or **data field** (section [2.2.5.4.9.5.2](#)) is in compact axis mode, then the **pivot items** (section [2.2.5.4.4](#)) or **data items** (section [2.2.5.4.9.5.1](#)) of the current **pivot field** (section [2.2.5.4.3](#)) or **data field** (section [2.2.5.4.9.5.2](#)) are placed in the same column as **pivot items** (section [2.2.5.4.4](#)) of the previous **pivot field** (section [2.2.5.4.3](#)) or **data field** (section [2.2.5.4.9.5.2](#)). **Pivot items** (section [2.2.5.4.4](#)) or **data items** (section [2.2.5.4.9.5.1](#)) are grouped by the parent **pivot item** (section [2.2.5.4.4](#)) or **data item** (section [2.2.5.4.9.5.1](#)) and placed immediately under the parent **pivot item** (section [2.2.5.4.4](#)) or **data item** (section [2.2.5.4.9.5.1](#)).

For the **data field** (section [2.2.5.4.9.5.2](#)), if the **fCompactData** field and the **fOutlineData** field of the **SXAddl_SXCView_SXDVer12Info record** (section [2.4.273.109](#)) are equal to 1, this specifies that the **data field** (section [2.2.5.4.9.5.2](#)) is in compact axis mode. If the **SXAddl_SXCView_SXDVer12Info** (section [2.4.273.109](#)) is not present, the **data field** (section [2.2.5.4.9.5.2](#)) is not in compact axis mode.

For **pivot fields** (section [2.2.5.4.3](#)), if the **fCompact** flag on the **SXAddl_SXCField12_SXDVer12Info record** (section [2.4.273.33](#)) is equal to 1 and **fOutline** field of the **SXVDEx** record is equal to 1, this specifies that the **pivot field** (section [2.2.5.4.3](#)) is in compact axis mode. If the **SXAddl_SXCField12_SXDVer12Info record** (section [2.4.273.33](#)) is not present, the **pivot field** (section [2.2.5.4.3](#)) is not in compact axis mode.

The **row area** can have special entries at the end for **grand totals**. If there are no **pivot fields** (section 2.2.5.4.3) and no **data field** (section 2.2.5.4.9.5.2) on the **row axis** (section 2.2.5.4.9.2), then the **row area** is empty.

2.2.5.4.10.1.2 Column Area

The **column area** contains **pivot fields** (section 2.2.5.4.3), the optional **data field** (section 2.2.5.4.9.5.2), or both placed on the **column axis** (section 2.2.5.4.9.3), along with associated **pivot items** (section 2.2.5.4.4) or **data items** (section 2.2.5.4.9.5.1). The first row of the **column area** can contain **pivot field** (section 2.2.5.4.3) captions, **data field** (section 2.2.5.4.9.5.2) captions, or both as specified by the **fNoHeaders** field of the **SXAddl_SXCView_SXDVer12Info record** (section 2.4.273.109).

If the **fNoHeaders** field of the **SXAddl_SXCView_SXDVer12Info record** (section 2.4.273.109) is equal to 0, and no **pivot fields** (section 2.2.5.4.3) are in **compact axis** mode, and the **data field** (section 2.2.5.4.9.5.2) is not in compact axis mode, then the **pivot field** (section 2.2.5.4.3) and **data field** (section 2.2.5.4.9.5.2) captions are placed sequentially in **cells** of the first row of the **column area** according to their placement on the **column axis** (section 2.2.5.4.9.3).

If the **fNoHeaders** field of the **SXAddl_SXCView_SXDVer12Info record** (section 2.4.273.109) is equal to 0, and any **pivot field** (section 2.2.5.4.3) is in compact axis mode or the **data field** (section 2.2.5.4.9.5.2) is in compact axis mode, the **pivot field** (section 2.2.5.4.3) and **data field** (section 2.2.5.4.9.5.2) captions are placed in the top **logical left** cell of the **column area**.

For the **data field** (section 2.2.5.4.9.5.2), if the **fCompactData** field and the **fOutlineData** field of the **SXAddl_SXCView_SXDVer12Info record** (section 2.4.273.109) are equal to 1, this specifies that the **data field** (section 2.2.5.4.9.5.2) is in compact axis mode. If the **SXAddl_SXCView_SXDVer12Info record** (section 2.4.273.109) is not present, the **data field** (section 2.2.5.4.9.5.2) is not in compact axis mode.

For **pivot fields** (section 2.2.5.4.3), if the **fCompact** flag on the **SXAddl_SXCField12_SXDVer12Info record** (section 2.4.273.33) is equal to 1 and **fOutline** field of the **SXVDEx** record is equal to 1, this specifies that the **pivot field** (section 2.2.5.4.3) is in compact axis mode. If the **SXAddl_SXCField12_SXDVer12Info record** (section 2.4.273.33) is not present, the **pivot field** (section 2.2.5.4.3) is not in compact axis mode.

The second row in the **column area** contains **pivot item** (section 2.2.5.4.4) or **data item** (section 2.2.5.4.9.5.1) labels for the **pivot field** (section 2.2.5.4.3) or **data field** (section 2.2.5.4.9.5.2) placed first on the **column axis** (section 2.2.5.4.9.3), and each subsequent row contains the **pivot item** (section 2.2.5.4.4) or **data item** (section 2.2.5.4.9.5.1) labels for **pivot fields** (section 2.2.5.4.3) or **data fields** (section 2.2.5.4.9.5.2) that occur later on the **column axis** (section 2.2.5.4.9.3). The row containing **pivot item** (section 2.2.5.4.4) or **data item** (section 2.2.5.4.9.5.1) labels for the **pivot field** (section 2.2.5.4.3) or **data field** (section 2.2.5.4.9.5.2) at position n is row $(n + 1)$ of the **column area**.

If the **fNoHeaders** field is equal to 1, the **pivot field** (section 2.2.5.4.3) and **data field** (section 2.2.5.4.9.5.2) captions are not displayed. The row containing **pivot item** (section 2.2.5.4.4) or **data item** (section 2.2.5.4.9.5.1) labels for the **pivot field** (section 2.2.5.4.3) or **data field** (section 2.2.5.4.9.5.2) at position n on the **column axis** (section 2.2.5.4.9.3) is row n of the **column area**.

The **column area** can have special entries at the end for **grand totals**.

2.2.5.4.10.1.3 Page Area

The **page area** contains **pivot fields** (section 2.2.5.4.3) that are placed on the **page axis** (section 2.2.5.4.9.1) for non-**OLAP PivotTable views** (section 2.2.5.4.2) and **pivot hierarchies** (section 2.2.5.4.5) that are placed on the **page axis** (section 2.2.5.4.9.1) for **OLAP PivotTable views** (section 2.2.5.4.2). For each **pivot field** (section 2.2.5.4.3) or **pivot hierarchy** (section 2.2.5.4.5) on the **page axis** (section 2.2.5.4.9.1), the page area contains a caption and information about the

current filtering associated with the **pivot field** (section 2.2.5.4.3) or **pivot hierarchy** (section 2.2.5.4.5) in the next **cell** at the **logical right**. The relative position of pairs of caption and filtering information is specified by the **SxView record** (section 2.4.313) and the **SXEx record** (section 2.4.282). For more details, see the [Location and Body](#) section.

2.2.5.4.10.1.4 Data Area

The **data area** contains summarized values for the **PivotTable view** (section 2.2.5.4). **Cells** in the **data area** contain summarized values for associated **data items** (section 2.2.5.4.9.5.1). The summarized value in a cell is restricted by all the **pivot items** (section 2.2.5.4.4) in the **column area** (section 2.2.5.4.10.1.2) that are located in the same column, by all the **pivot items** (section 2.2.5.4.4) in the **row area** (section 2.2.5.4.10.1.1) that are located in the same row, and by any page filter applied, as specified in the [Page Axis](#) section.

If the **row area** (section 2.2.5.4.10.1.1) has a **grand total**, then the value in that row is not restricted by **pivot items** (section 2.2.5.4.4) from the **row area** (section 2.2.5.4.10.1.1). If the **column area** (section 2.2.5.4.10.1.2) has a grand total, then the value in that column is not restricted by **pivot items** (section 2.2.5.4.4) from the **column area** (section 2.2.5.4.10.1.2). If the **PivotTable view** (section 2.2.5.4) has more than one **data item** (section 2.2.5.4.9.5.1), then the associated **data item** (section 2.2.5.4.9.5.1) is the one that is located in the same column in the **column area** (section 2.2.5.4.10.1.2) or the same row in the **row area** (section 2.2.5.4.10.1.1) as the cell with the summarized value.

If a **PivotTable view** (section 2.2.5.4) has zero **data items** (section 2.2.5.4.9.5.1) then the **data area** is empty.

2.2.5.4.10.2 Truncation

When a **PivotTable report** (section 2.2.5) does not fit within the boundaries of the **sheet (2)** it is truncated from the **logical right** and the bottom. It is truncated such that a part of the **PivotTable report** (section 2.2.5) is displayed within the sheet boundaries.

2.2.5.4.10.3 Pivot Lines

A **pivot line** specifies a collection of **pivot line entries** (section 2.2.5.4.10.4) for a single row or column in the **PivotTable report** (section 2.2.5).

A **pivot line** in the **column area** (section 2.2.5.4.10.1.2) is the **range** defined by the intersection of:

- A column.
- A set of **cells** in the **column area** (section 2.2.5.4.10.1.2). These are cells that contain **pivot items** (section 2.2.5.4.4), **data items** (section 2.2.5.4.9.5.1), blank cells, or a **grand total**.

A **pivot line** in the **row area** (section 2.2.5.4.10.1.1) is the range defined by the intersection of:

- A row.
- A set of cells in the **row area** (section 2.2.5.4.10.1.1). These are cells that contain **pivot items** (section 2.2.5.4.4), **data items** (section 2.2.5.4.9.5.1), blank cells, or a grand total.

A **pivot line** is specified by a sequence of records that conforms to the **PIVOTLI rule** (section 2.1.7.20.5). If either the **cRw** field or the **cCol** field of the associated **SxView record** (section 2.4.313) is greater than 0, then two **PIVOTLI rules** (section 2.1.7.20.5) MUST exist in the sequence of records that conforms to the **PIVOTCORE rule** (section 2.1.7.20.5), otherwise a **PIVOTLI rule** (section 2.1.7.20.5) MUST NOT exist in the **PIVOTCORE rule** (section 2.1.7.20.5).

If **PIVOTLI rules** (section 2.1.7.20.5) for a **PivotTable view** (section 2.2.5.4) exist, the first **PIVOTLI rule** (section 2.1.7.20.5) specifies the collection of **pivot lines** for the **row area** (section

2.2.5.4.10.1.1). The order of the **SXLIItem structures** (section [2.5.259](#)) in the **rgsxli** field of the **SXLI record** (section [2.4.293](#)) specifies the top to bottom order of the **pivot lines** of the **row area** (section 2.2.5.4.10.1.1).

If **PIVOTLI rules** (section 2.1.7.20.5) for a **PivotTable view** (section 2.2.5.4) exist, the second **PIVOTLI rule** (section 2.1.7.20.5) specifies the collection of **pivot lines** for the **column area** (section 2.2.5.4.10.1.2). The order of the **SXLIItem structures** (section 2.5.259) in the **rgsxli** field of the **SXLI record** (section 2.4.293) specifies the **logical left** to **logical right** order of the **pivot lines** of the **column area** (section 2.2.5.4.10.1.2).

Each individual **pivot line** is specified by an **SXLIItem structure** (section 2.5.259) in the **rgsxli** field of the associated **SXLI record** (section 2.4.293). Each **pivot line** contains a number of **pivot line entries** (section 2.2.5.4.10.4). **Pivot line entries** (section 2.2.5.4.10.4) are specified by the **rgisxvi** field of the **SXLIItem structure** (section 2.5.259).

The first **pivot line** in the **row area** (section 2.2.5.4.10.1.1) or the **column area** (section 2.2.5.4.10.1.2) MUST have a **cSic** field of its associated **SXLIItem structure** (section 2.5.259) equal to 0.

The following shows an example of a **PivotTable report** (section 2.2.5) and the pivot lines corresponding to each row in the **row area** (section 2.2.5.4.10.1.1).

Country	State	City	Sales	Pivot Line
Australia	Queensland	Brisbane	\$295,353.58	{Australia, Queensland, Brisbane}
		Hawthorne	\$226,706.44	{Australia, Queensland, Hawthorne}
	Queensland Total		\$522,060.02	{Australia, Queensland Total}
Australia Total			\$522,060.02	{Australia Total}
United States	California	San Francisco	\$68,659.12	{United States, California, San Francisco}
	California Total		\$68,659.12	{United States, California Total}
	Washington	Seattle	\$75,164.86	{United States, Washington, Seattle}
		Tacoma	\$101,862.27	{United States, Washinton, Tacoma}
	Washington Total		\$177,027.13	{United States, Washington Total}
United States Total			\$245,686.26	{United States Total}
Grand Total			\$767,746.28	{Grand Total}

Figure 16: PivotTable and a table illustrating each pivot line

2.2.5.4.10.4 Pivot Line Entries

Pivot line entries specify references to the **pivot items** (section [2.2.5.4.4](#)), **data items** (section [2.2.5.4.9.5.1](#)), or blank items of a **pivot line** (section [2.2.5.4.10.3](#)). **Pivot line entries** are specified by the records that conform to the **PIVOTLI rules** (section [2.1.7.20.5](#)) in the **PIVOTCORE rule** (section 2.1.7.20.5). A **pivot line entry** is an element in the array specified by the **rgisxvi** field of the **SXLIItem structure** (section [2.5.259](#)).

All **pivot line entries** that have an index less than the value specified by the **cSic** field of the **SXLIItem structure** (section 2.5.259) of a given **pivot line** (section 2.2.5.4.10.3) are identical to those of the **pivot line** (section 2.2.5.4.10.3) preceding the given **pivot line** (section 2.2.5.4.10.3).

For the purposes of the rest of this section, *n* specifies a position of the **pivot line entry** of a given **pivot line** (section 2.2.5.4.10.3).

If the value of *n* is less than the **cSic** field of the **SXLIItem structure** (section 2.5.259) of a given **pivot line** (section 2.2.5.4.10.3), then the **pivot line entry** at position *n* is identical to the corresponding **pivot line entry** of the **pivot line** (section 2.2.5.4.10.3) preceding the given **pivot line** (section 2.2.5.4.10.3).

If the value of n is greater than or equal to the **cSic** field of the **SXLIItem structure** (section 2.5.259) of a given **pivot line** (section 2.2.5.4.10.3), then the value of n is equal to the sum of the **cSic** field of the **SXLIItem structure** (section 2.5.259) and the current index in the **rgisxvi** field of the **SXLIItem structure** (section 2.5.259) of the given **pivot line** (section 2.2.5.4.10.3).

If a **pivot line entry** is in a **pivot line** (section 2.2.5.4.10.3) in the **row area** (section [2.2.5.4.10.1.1](#)), each **pivot line entry** at a position n specifies a **pivot item** (section 2.2.5.4.4) index of a **pivot item** (section 2.2.5.4.4) in the n th **pivot field** (section [2.2.5.4.3](#)) on the **row axis** (section [2.2.5.4.9.2](#)) or specifies a **data item** (section 2.2.5.4.9.5.1) index, if the n th field of the **row axis** (section 2.2.5.4.9.2) is the **data field** (section [2.2.5.4.9.5.2](#)).

If a **pivot line entry** is in a **pivot line** (section 2.2.5.4.10.3) in the **column area** (section [2.2.5.4.10.1.2](#)), each pivot line entry at a position n specifies the **pivot item** (section 2.2.5.4.4) index of a **pivot item** (section 2.2.5.4.4) in the n th **pivot field** (section 2.2.5.4.3) on the **column axis** (section [2.2.5.4.9.3](#)) or specifies a **data item** (section 2.2.5.4.9.5.1) index, if the n th field on the **column area** (section 2.2.5.4.10.1.2) is the **data field** (section 2.2.5.4.9.5.2).

If the n th **pivot field** (section 2.2.5.4.3) on the **row axis** (section 2.2.5.4.9.2) or **column axis** (section 2.2.5.4.9.3) is the **data field** (section 2.2.5.4.9.5.2), the **pivot line entry** is a **data items** (section 2.2.5.4.9.5.1) index, as specified by the Data Items section.

Pivot items (section 2.2.5.4.4) are specified sequentially from **logical left** to **logical right** for row **pivot lines** (section 2.2.5.4.10.3), and from top to bottom for column **pivot lines** (section 2.2.5.4.10.3).

A value of 0x7FFF is used to specify the absence of a **pivot item** (section 2.2.5.4.4) or **data item** (section 2.2.5.4.9.5.1).

2.2.5.4.11 PivotTable Rules

A **PivotTable rule** is used to specify **ranges** of **cells** in the **PivotTable report** (section [2.2.5](#)). A **PivotTable rule** is specified by the sequence of records that conform to the **PIVOTRULE rule** (section [2.1.7.20.6](#)) or by an **SxcSXRule class** (section [2.2.5.1.1.1.11](#)). Each **PivotTable rule** has references to specific area of a **PivotTable report** (section 2.2.5), **pivot fields** (section 2.2.5.4.3), **pivot items** (section [2.2.5.4.4](#)), **data items** (section [2.2.5.4.9.5.1](#)), or **cache items** (section [2.2.5.3.6](#)). These references are used to determine the ranges of cells in the **PivotTable report** (section 2.2.5). The various areas of the **PivotTable report** (section 2.2.5) specified in the [Location and Body](#) section and the **pivot lines** (section [2.2.5.4.10.3](#)) can be used in this determination.

The **SxRule** (section [2.4.301](#)) or **SXAddl_SXCSXrule_SXDSXrule** (section [2.4.273.99](#)) records specify information for a **PivotTable rule**, including restrictions such as what areas of the **PivotTable report** (section 2.2.5) the **PivotTable rule** applies to. In the case of the **SxRule record** (section 2.4.301) the fCacheBased field specifies whether the **PivotTable rule** specifies **cache items** (section 2.2.5.3.6) instead of **pivot items** (section 2.2.5.4.4).

A **PivotTable rule** can have PivotTable rule filters. A PivotTable rule filter is specified by the sequence of records that conform to a **PRFILTER rule** (section 2.1.7.20.6) or an **SxcSXfilt class** (section [2.2.5.1.1.1.12](#)). A PivotTable rule filter specifies a set of **pivot items** (section 2.2.5.4.4), **data items** (section 2.2.5.4.9.5.1), or **cache items** (section 2.2.5.3.6) for an individual **pivot field** (section 2.2.5.4.3), **data field** (section [2.2.5.4.9.5.2](#)), or **cache field** (section [2.2.5.3.5](#)).

Ranges of cells that are associated, in the **PivotTable report** (section 2.2.5), with any **pivot item** (section 2.2.5.4.4), **data item** (section 2.2.5.4.9.5.1), or **cache item** (section 2.2.5.3.6) from a PivotTable rule filter and that meet other restrictions as specified by the **SxFilt** (section [2.4.285](#)) or **SXAddl_SXCSXfilt_SXDSXfilt** (section [2.4.273.77](#)) record are associated with the PivotTable rule filter. Ranges of cells that are associated with every PivotTable rule filter of the PivotTable **rule** and that meet other restrictions of the **PivotTable rule** are the ranges of cells specified by the **PivotTable rule**.

A range of cells is associated with a particular **cache item** (section 2.2.5.3.6) if it is associated with the **pivot item** (section 2.2.5.4.4) that has an association with that **cache item** (section 2.2.5.3.6).

2.2.6 Styles

This overview describes how formatting and protection information for **cells** in a **sheet (1)** is specified.

Cell formatting is composed of several sets of properties:

- **Font** properties (bold, italic, font color, font size, etc...)
- **Fill** properties (**foreground color**, **background color**, pattern, gradient, etc...)
- Alignment properties (left, center, right alignment, etc...)
- **Border** properties (left, right, top, bottom, thick or thin, color, etc...)
- Number formatting properties (date, time, number of decimal places, etc...)
- **Protection** properties (**locked**, **hidden**, etc...)

These properties, as a whole, describe how a particular cell is displayed and printed.

There are two types of objects that contain formatting properties. They are **XFs** (section 2.2.6.1) and **DXFs** (section 2.2.6.2). In general, **XFs** (section 2.2.6.1) describe the formatting directly associated with a cell, and **DXFs** (section 2.2.6.2) describe additional formatting properties that can be applied to one or more cells.

2.2.6.1 XFs

XFs specify formatting for **cells** and **cell styles** (section 2.2.6.1.2). **XFs** are specified by records in the **XFS collection** (section 2.1.7.20.3). This collection contains **XF** (section 2.4.353) and **XFExt** (section 2.4.355) records, which specify formatting properties.

2.2.6.1.1 Cell XFs

A **cell XF** is specified by an **XF** record (section 2.4.353) (and an optional **XFExt record** (section 2.4.355)) where the **fStyle** field of the **XF** record (section 2.4.353) equals 0. Each **cell** MUST reference a **cell XF**. These records specify the complete set of formatting properties for the cells that reference them.

2.2.6.1.2 Cell Styles

Cell styles specify a set of formatting properties that can be associated with one or more **cells**. **Cell styles** provide two benefits:

- The set of formatting properties in a **cell style** can be applied to one or more cells in a single operation.
- After a **cell style** is applied to a cell, subsequent changes to the formatting properties in the **cell style** can be propagated to the cell automatically.

For example, if it is desired that multiple cells in a **sheet (1)** share a common set of formatting properties, like bold **font** with a blue **fill**, then **cell styles** make it convenient to apply this set of formatting, and potentially modify the set later.

Supporting information for a **cell style** is specified in a **Style** record (section [2.4.269](#)) (and optional **StyleExt** record (section [2.4.270](#))). This information includes a **friendly name** for the **cell style** and an index to the **cell style XF** (section [2.2.6.1.2.1](#)) that specifies the formatting for the **cell style**.

2.2.6.1.2.1 Cell Style XFs

A **cell style XF** is specified by an **XF** record (section [2.4.353](#)) (and an optional **XFExt record** (section [2.4.355](#))) where the **fStyle** field of the **XF** record (section [2.4.353](#)) equals 1. Each **cell** MUST reference a **cell XF** (section [2.2.6.1.1](#)), and each **cell XF** (section [2.2.6.1.1](#)) MUST reference a **cell style XF** with the **ixfParent** field.

2.2.6.1.2.2 Normal Style

At least one **cell style** (section [2.2.6.1.2](#)) MUST be included in the **STYLES collection** (section [2.1.7.20.3](#)) and this **cell style** (section [2.2.6.1.2](#)) is called the **Normal style**. The **Normal style** MUST reference the first **XF** record (section [2.4.353](#)) in the **XFS collection** (section [2.1.7.20.3](#)), and this **XF** record (section [2.4.353](#)) MUST be a **cell style XF** (section [2.2.6.1.2.1](#)), where the **fStyle** field equals 1.

The **Normal style**, being the only required **cell style** (section [2.2.6.1.2](#)), ensures that all **cells** have a **cell style** (section [2.2.6.1.2](#)) to reference. The **Normal style** also provides a convenient object in which to store default cell formatting properties for an entire **workbook**, because all cells will typically reference the **Normal style** by default, until they are modified to reference a different **cell style** (section [2.2.6.1.2](#)).

2.2.6.2 Differential Formatting (DXFs)

Like **XF**s (section [2.2.6.1](#)), **DXFs** define a set of formatting properties. Unlike **XF**s (section [2.2.6.1](#)), **DXFs** can define any number of formatting properties, from just one to all of them.

DXFs provide a way for features to reference a set of formatting properties. How those properties are used depends on the feature. The subsections that follow describe each of these features and how they use **DXFs**.

DXFs can be specified in several different ways. The following records and structures specify a **DXF**:

- **DXF** (section [2.4.97](#))
- **DXFN** (section [2.5.95](#))
- **DXFN12** (section [2.5.96](#))
- **DXFN12List** (section [2.5.97](#))
- **DXFN12NoCB** (section [2.5.98](#))

DXF records (section [2.4.97](#)) are saved into a collection as specified by **Globals Substream ABNF** and referenced with a **DXFId** (section [2.5.94](#)).

The remaining structures are saved within containing records, such as **CF** (section [2.4.42](#)) and **SxDXF** (section [2.4.280](#)). **DXFN12** (section [2.5.96](#)), **DXFN12List** (section [2.5.97](#)), and **DXFN12NoCB** (section [2.5.98](#)) are extensions of the **DXFN structure** (section [2.5.95](#)).

2.2.6.2.1 Conditional Formatting

Some **conditional formatting** rules, as specified by the records in the **CONDFMT collection** (section [2.1.7.20.5](#)), reference a **DXF** (section [2.2.6.2](#)). That **DXF** (section [2.2.6.2](#)) describes additional formatting applied to **cells** within the bounds of the rule, if the rule's condition is TRUE for those cells.

2.2.6.2.2 Table Style Elements

Table style elements, as specified by **TableStyleElement** (section [2.4.321](#)), can reference a **DXF** (section [2.2.6.2](#)). That **DXF** (section 2.2.6.2) describes additional formatting applied to **cells** within the bounds of the **table style element**.

2.2.6.2.3 Table Block-Level Formatting

Table block-level formatting, as specified by **List12BlockLevel** (section [2.5.174](#)), can reference one or more **DXFs** (section [2.2.6.2](#)). These **DXFs** (section 2.2.6.2) represent formatting that can be applied to the **cells** within the appropriate regions of the **table**.

2.2.6.2.4 PivotTable Areas

A **PivotTable format** (section [2.2.5](#)), as specified by an **SxFormat** record (section [2.4.287](#)), can specify a **DXF** (section [2.2.6.2](#)). This **DXF** (section 2.2.6.2) represents formatting that can be applied to the **cells** within the appropriate area of the **PivotTable view** (section [2.2.5.4](#)).

2.2.6.2.5 Sorting and Filtering

Sorting, as specified by **SortCond12** (section [2.5.242](#)), and filtering, as specified by **AutoFilter12** (section [2.4.7](#)), can include formatting properties as part of their criteria. These properties are stored as **DXFs** (section [2.2.6.2](#)). For example, a **filter** criteria that is "filter only **cells** with red **font** color" will reference a **DXF** (section 2.2.6.2) with the property "font color = red".

2.2.6.3 Table Styles

Table styles specify additional formatting for **cells** inside **tables** or **PivotTable views** (section [2.2.5.4](#)).

Tables can specify an applied **table style** with the **List12TableStyleClientInfo** record (section [2.5.176](#)). **PivotTable views** (section 2.2.5.4) specify an applied **table style** with the **SXAddl_SXCVIEW_SXDTableStyleClient** record (section [2.4.273.107](#)). These two records reference a **table style** by name with the **stListStyleName** and **stName** fields, respectively.

Table styles are either built-in or custom. Built-in **table styles** are specified in [\[ECMA-376\]](#) part 4, 3.8.40. Custom **table styles** used in a **workbook** are specified in the collection of records beginning with **TableStyles** (section [2.4.322](#)).

A **table style** consists of a collection of **table style elements** (section [2.2.6.2.2](#)). For custom **table styles**, these elements are specified by the collection of **TableStyleElement** records (section [2.4.321](#)) following the **TableStyle** record (section [2.4.320](#)).

Each **table style element** (section 2.2.6.2.2) specifies the formatting to be applied to cells in a particular region of the table or **PivotTable view** (section 2.2.5.4). These regions are specified by the possible values of the **tseType** field of the **TableStyleElement** record (section 2.4.321).

2.2.6.4 Format Conflicts

As described previously, the formatting to be displayed or printed for a particular **cell** can be specified in several independent records. It is up to the application to resolve conflicting formatting properties for a particular cell.

As an example, say a cell has a **conditional format** (section [2.2.6.2.1](#)) applied and also falls within the bounds of a **table** with a **table style** (section [2.2.6.3](#)). Furthermore, say the **cell XF** (section [2.2.6.1.1](#)), **conditional format** (section 2.2.6.2.1) and **table style element** (section [2.2.6.2.2](#)) all specify a different **font** color. It is up to the application to decide the appropriate font color to use in this situation.

2.2.7 External References

The **external references** infrastructure exists to support **formulas** (section [2.2.2](#)) which reference **data sources** outside the scope of the **sheet (1)** on which the **formula** (section 2.2.2) resides. These sources could be other sheets (1) in the same **workbook**, data in another workbook, **DDE** links or **Object Linking and Embedding (OLE)** links. A workbook that uses **external references** contains a collection of **XTI records** (section [2.5.344](#)) that in turn reference **SupBook records** (section [2.4.271](#)) that specify the source of the data.

2.2.7.1 External Reference Consumers

Within the formula, only certain **formula elements** (section [2.2.2.6](#)) can contain external references. These specific **formula elements** (section 2.2.2.6) contain an **XtiIndex structure** (section [2.5.198.119](#)) specifying an **XTI** (section [2.5.344](#)), which in turn specifies the location and type of the external reference data. Only the following **Ptg structures** (section [2.5.198.25](#)) can be **external reference consumers**:

- **PtgRef3d** (section [2.5.198.85](#))
- **PtgRefErr3d** (section [2.5.198.87](#))
- **PtgArea3d** (section [2.5.198.28](#))
- **PtgAreaErr3d** (section [2.5.198.30](#))
- **PtgNameX** (section [2.5.198.77](#))

2.2.7.2 Supporting Link

Each **formula element** (section [2.2.2.6](#)) which references external data refers to a **XTI** (section [2.5.344](#)). The **XTI** (section 2.5.344) references a **SupBook record** (section [2.4.271](#)) that specifies the type of **supporting link** and, in certain cases, specifies additional data about the **supporting link**.

There are several types of **supporting links**. The type of the **supporting link** used is specified by the **cch** and **virtPath** fields of the **SupBook record** (section 2.4.271). **Supporting link** types are specified in the following table:

Supporting Link Type	Meaning
Self-Referencing	A reference to the current workbook . This supporting link type supports cross- sheet (1) references, where the target sheets (1) are specified by the XTI (section 2.5.344). This record also supports defined name or User Defined Function (UDF) references on the same book.
Same-Sheet Referencing	A reference to the active sheet in the context of the consuming formula (section 2.2.2). This supporting link type is used by formulas in macro sheets and in defined names to reference the sheet (1) of the caller.
Add-in Referencing	A reference to a UDF on any Excel Linked Library (XLL) or COM add-in.
External Workbook Referencing	A reference to an External Workbook (section 2.2.7.3).
DDE Data Source Referencing	A reference to a DDE Data Source (section 2.2.7.6).
OLE Data Source Referencing	A reference to an OLE Data Source (section 2.2.7.8).
Unused	An unused supporting link . A reference to this type of supporting link can be specified by an XTI (section 2.5.344), but that XTI (section 2.5.344) MUST NOT be

Supporting Link Type	Meaning
	used by any external reference consumer (section 2.2.7.1).

2.2.7.3 External Workbook

An external workbook link is a reference to a **workbook** other than the one in which the source **formula** (section [2.2.2](#)) resides. It contains the referencing **expression**, and data relating to that expression. This data includes the workbook location, **sheet (1)** names, **external defined names** (section [2.2.7.4](#)), and an **external cell cache** (section [2.2.7.5](#)) for referenced cells in that workbook.

2.2.7.4 External Defined Name

An external defined name is a reference to a **defined name** in an **external workbook** (section [2.2.7.3](#)). The records specifying the external defined name will provide the name, scope, and **formula** (section [2.2.2](#)) of the defined name on that **workbook**. The restrictions on the types of **formulas** (section [2.2.2](#)) supported in **external defined names** are described in **ExtNameParsedFormula** (section [2.5.198.10](#)).

2.2.7.5 External Cell Cache

To allow external cell references to be calculated without opening the referenced **workbook**, an **external cell cache** is stored in the file which contains cached values for cells in a **sheet (1)** in an **external workbook** (section [2.2.7.3](#)). The **external cell cache** contains **cell** values of the specific cells that are referenced in that sheet (1). The beginning of an **external cell cache** is specified by the **XCT** record (section [2.4.352](#)).

The **external cell cache** is composed of a collection of sequences of cells that correspond to cells in the source sheet (1). Each cell sequence is specified by a **CRN** record (section [2.4.65](#)).

2.2.7.6 DDE Data Source

A **DDE data source** specifies information about the **DDE server** and **DDE topic** name of a **Dynamic Data Exchange (DDE)** connection. A **DDE data source** is specified by the **SupBook record** (section [2.4.271](#)).

2.2.7.7 DDE Data Item

A **DDE data item** specifies the name and properties of a **DDE** item. It also contains cached values from the most recent DDE data update. A **DDE data item** is specified by the **ExternName** record (section [2.4.105](#)).

2.2.7.8 OLE Data Source

An **OLE data source** specifies information about an **OLE2** data connection. It specifies the path to the OLE2 **data source** file and the **ProgID** of the application handler. An **OLE data source** is specified by the **SupBook record** (section [2.4.271](#)).

2.2.7.9 OLE Data Item

An **OLE data item** specifies the name and properties of a connection to an **OLE2** data object. Unlike **DDE Data Sources** (section [2.2.7.6](#)), **OLE Data Sources** (section [2.2.7.8](#)) do not store cached data returned by OLE2 data objects. An **OLE data item** is specified by the **ExternName** record (section [2.4.105](#)).

2.2.8 External Connections

A **workbook** often pulls in data from external **data sources**, such as a database or an **OLAP cube**. An **external connection** represents a link between a workbook and a particular external data source. It contains properties about the way that the application establishes the connection to the data source and retrieves the data, such as the type of **data provider** (**OLE DB**, **ODBC**, and so on), a **server name**, security information, and a command to execute on the server. In addition, the **external connection** contains details about the way the connection is used in the workbook, such as how often to refresh the data.

A data connection object contains **external connection** information for an external data source that a workbook uses. Data connection objects are independent of the constructs in the workbook that display data, such as **tables** or **PivotTables** (section [2.2.5](#)).

A connection definition can be established in an **external connection** file for easier sharing and reuse, but this overview describes the representation for external data connections that are directly embedded within a workbook file. This embedded representation is required whenever external data is used, and ensures portability of the document and continued operation of the external query in the most cases.

An **external connection** is specified by a combination of the records defined in **DBQUERY_WORKBOOK** (section [2.1.7.20.3](#)), **DBQUERY_WORKSHEET** (section [2.1.7.20.5](#)), **DBQUERYEXT** (section [2.1.7.20.5](#)) and **SXADDLDBQUERY** (section [2.1.7.20.6](#)), and the **DConn** record (section [2.4.84](#)).

If an **external connection** is not used by any workbook object, it is represented only by a **DConn** record (section [2.4.84](#)) and the **fStandAlone** field of the **DConn** record (section [2.4.84](#)) is set to 1.

2.2.8.1 Connection Name

Each external connection has a unique name, which can be used by the application as a user-friendly name for the connection, for example, for UI purposes. The **connection name** is specified by the **rgchConnectionName** field of the **DConn** record (section [2.4.84](#)).

2.2.8.2 External Connection Files

An **external connection** file specifies an external connection in a separate file (external to the **workbook**). An **external connection** file enables managing connection information separately from a specific workbook and sharing it among multiple workbooks. It is used for creating a new data connection in a workbook or for restoring a lost connection. The **stSourceConnectionFile** field of the **SXAddl_SXCQuery_SXDSrcConnFile** record (section [2.4.273.65](#)) and the **rgchSourceConnectionFile** field of the **DConn** record (section [2.4.84](#)) specify a path to an external connection file.

2.2.8.3 OLE DB Connections

An **OLE DB connection** is a connection to an **OLE DB data provider**. An external connection is an **OLE DB connection** if the **dbt** field of the **DbQuery** record (section [2.4.80](#)) is 0x5, the **dbt** field of the **DBQueryExt** record (section [2.4.81](#)) is **DBT_OLEDB** (section [2.5.64](#)), and the **dbt** field of the **DConn** record (section [2.4.84](#)) is **DBT_OLEDB** (section [2.5.64](#)). For more information about OLE DB, see [\[MSDN-OLEDBP-OI\]](#).

2.2.8.3.1 OLAP Connections

An **OLAP connection** is a connection to an **OLE DB** for **OLAP data provider**. An OLE DB connection is an **OLAP connection** if the **dbost** field of the **ConnGrbitDbtOledb** structure (section [2.5.59](#)) is 0x1.

2.2.8.4 ODBC Connections

An **ODBC connection** is a connection to an **ODBC data provider**. An external connection is an **ODBC connection** if the **dbt** field of the **DbQuery** record (section [2.4.80](#)) is 0x1, the **dbt** field of the **DBQueryExt** record (section [2.4.81](#)) is **DBT_ODBC** (section [2.5.64](#)), and the **dbt** field of the **DConn** record (section [2.4.84](#)) is **DBT_ODBC** (section [2.5.64](#)). For more information about ODBC, see [\[MSFT-ODBCODCO\]](#).

2.2.8.5 Web Connections

A **Web connection** pulls the content of a Web page, or part of a Web page (an **HTML** table), into the **workbook**. An external connection is a **Web connection** if the **dbt** field of the **DbQuery** record (section [2.4.80](#)) is 0x4, the **dbt** field of the **DBQueryExt** record (section [2.4.81](#)) is **DBT_WEB** (section [2.5.64](#)), and the **dbt** field of the **DConn** record (section [2.4.84](#)) is **DBT_WEB** (section [2.5.64](#)).

2.2.8.6 Text Import Connections

A **text import connection** pulls in data from a structured text file into the **workbook**. An external connection is a **text import connection** if the **dbt** field of the **DbQuery** record (section [2.4.80](#)) is 0x6, the **dbt** field of the **DBQueryExt** record (section [2.4.81](#)) is **DBT_TXT** (section [2.5.64](#)), and the **dbt** field of the **DConn** record (section [2.4.84](#)) is **DBT_TXT** (section [2.5.64](#)).

2.2.8.7 ADO Recordset Connections

An **ADO** recordset pulls in data from a set of records in an ADO **data provider**. An external connection is an **ADO recordset connection** if the **dbt** field of the **DbQuery** record (section [2.4.80](#)) is 0x7, the **dbt** field of the **DBQueryExt** record (section [2.4.81](#)) is **DBT_ADO** (section [2.5.64](#)), and the **dbt** field of the **DConn** record (section [2.4.84](#)) is **DBT_ADO** (section [2.5.64](#)).

Note: For this type of connection, the file format does not contain sufficient information for establishing the connection and fetching a recordset. Data is provided to the application through another mechanism, for example by script code using an **object model**.

2.2.8.8 DAO Recordset Connections

A DAO recordset pulls in data from a set of records in a DAO **data provider**. An external connection is a **DAO recordset connection** if the **dbt** field of the **DbQuery** record (section [2.4.80](#)) is 0x2, the **dbt** field of the **DBQueryExt** record (section [2.4.81](#)) is **DBT_DAO** (section [2.5.64](#)), and the **dbt** field of the **DConn** record (section [2.4.84](#)) is **DBT_DAO** (section [2.5.64](#)).

Note: For this type of connection, the file format does not contain sufficient information for establishing the connection and fetching a recordset. Data is provided to the application through another mechanism, for example by script code using an **object model**.

2.2.9 Password Verifier Algorithm

Several records (**Password** (section [2.4.191](#)), **FileSharing** (section [2.4.118](#)), **Prot4RevPass** (section [2.4.206](#)), **FeatProtection** (section [2.5.124](#)), and **FilePass** (section [2.4.117](#))) use a password verifier to provide a locking and unlocking system for viewing or editing parts of the **workbook**. This password verifier is used to prevent accidental editing, and is not designed to be used as a security feature. The verifier value is calculated in two stages. First, the provided **Unicode** password string is converted to a new character string in the **American National Standards Institute (ANSI) character set** code page of the current system using the algorithm specified in the **revisionsPassword** attribute in [\[ECMA-376\]](#) part 4, 3.2.29. Second, this string is input into the **XOR**

obfuscation algorithm specified in [\[MS-OFFCRYPTO\]](#), 2.3.7.1, Binary Document Password Verifier Derivation Method 1 to produce a 16-bit password verifier value.

See the [Security Considerations](#) section for information about security concerns related to the use of this algorithm for password verification in this file format. [<19>](#)

2.2.10 Encryption (Password to Open)

Workbook files can contain sensitive information that needs to be protected. A file can be protected by **encrypting** it using a password [<20>](#). Once a file is **encrypted**, the data can only be accessed by decrypting the file using the same password.

If a file in this format is saved with **encryption** it MUST be saved with **XOR obfuscation** [<21>](#) as specified in [\[MS-OFFCRYPTO\]](#) section 2.3.7, or RC4 **encryption** as specified in [\[MS-OFFCRYPTO\]](#) section 2.3.6, or one of a number of RC4 CryptoAPI **encryption** [<22>](#) algorithms as specified in [\[MS-OFFCRYPTO\]](#) section 2.3.5. The specific obfuscation or **encryption** method being used, and the associated obfuscation or **encryption** information, is specified in the **FilePass** record (section [2.4.117](#)).

If RC4 CryptoAPI **encryption** is used, certain storages and **streams** are stored in the **Encryption Stream** (section [2.1.7.6](#)) as specified in [\[MS-OFFCRYPTO\]](#) section 2.3.5.3. See the following table for details.

Storage/Stream	XOR obfuscation or RC4 encryption	RC4 CryptoAPI encryption
Component Object Stream (section 2.1.7.1)	Not encrypted	Not encrypted.
Control Stream (section 2.1.7.2)	Not encrypted	Encrypted in encryption stream (section 2.1.7.6).
Data Spaces Storage (section 2.1.7.3)	Not encrypted	Not encrypted.
Document Summary Information Stream (section 2.1.7.4)	Not encrypted	Encrypted in encryption stream (section 2.1.7.6) if and only if flag is set **
Embedding Storage (section 2.1.7.5)	Not encrypted	Encrypted in encryption stream (section 2.1.7.6).
Link Storage (section 2.1.7.7)	Not encrypted	Encrypted in encryption stream (section 2.1.7.6).
List Data Stream (section 2.1.7.8)	Not encrypted	Encrypted in encryption stream (section 2.1.7.6).
Office Data Store Storage (section 2.1.7.9)	Not encrypted	Not encrypted.
Office Toolbars Stream (section 2.1.7.10)	Not encrypted	Not encrypted.
OLE Stream (section 2.1.7.11)	Not encrypted	Not encrypted.
Pivot Cache Storage (section 2.1.7.12)*	Encrypted	Encrypted.
Protected Content Stream (section 2.1.7.13)	Not encrypted	Not encrypted.
Revision Stream (section 2.1.7.14)*	Encrypted	Encrypted.
Signatures Stream (section 2.1.7.15)	Not encrypted	Not encrypted.
Summary Information Stream (section 2.1.7.16)	Not encrypted	Encrypted in encryption stream (section 2.1.7.6) if and only if flag is set **

Storage/Stream	XOR obfuscation or RC4 encryption	RC4 CryptoAPI encryption
User Names Stream (section 2.1.7.17)*	Not encrypted	Not encrypted.
VBA Storage (section 2.1.7.18)	Not encrypted	Not encrypted.
Viewer Content Stream (section 2.1.7.19)	Not encrypted	Not encrypted
Workbook Stream (section 2.1.7.20)*	Encrypted	Encrypted.
XML Signatures Storage (section 2.1.7.21)	Not encrypted	Not encrypted.
XML Stream (section 2.1.7.22)	Not encrypted	Encrypted in encryption stream (section 2.1.7.6)

* The indicated items specify either streams that contain **BIFF** records as specified in **Record** (section [2.1.4](#)) or storages that contain streams that contain BIFF records as specified in **Record** (section 2.1.4). When obfuscating or **encrypting** BIFF records in these streams the record type and record size components MUST NOT be obfuscated or encrypted. In addition the following records MUST NOT be obfuscated or **encrypted**: **BOF** (section [2.4.21](#)), **FilePass** (section 2.4.117), **UsrExcl** (section [2.4.339](#)), **FileLock** (section [2.4.116](#)), **InterfaceHdr** (section [2.4.146](#)), **RRDInfo** (section [2.4.227](#)), and **RRDHead** (section [2.4.226](#)). Additionally, the **IbPlyPos** field of the **BoundSheet8** record (section [2.4.28](#)) MUST NOT be **encrypted**.

** The indicated streams for the indicated **encryption** method MUST be **encrypted** if and only if the 0x08 bit of **EncryptionHeader.flags** is equal to 0. **EncryptionHeader.flags** is specified in [MS-OFFCRYPTO] section 2.3.5.1.

For XOR obfuscation, the obfuscation key is generated as specified in the [Password Verifier Algorithm](#) section. The algorithm for XOR obfuscation is specified in [MS-OFFCRYPTO] section 2.3.7. The **Unicode** password string is converted to a new character string in the ANSI code page of the current system using the algorithm specified in the **revisionsPassword** attribute in [\[ECMA-376\]](#) part 4, 3.2.29. The new string is then provided as input into the XOR obfuscation array initialization as specified in [MS-OFFCRYPTO] section 2.3.7.2. The initialized array is then used by the algorithm specified in [MS-OFFCRYPTO] section 2.3.7.3 to obfuscate the file data.

For RC4 **encryption** and RC4 CryptoAPI **encryption**, the Unicode password string is used to generate the **encryption** key as specified in [MS-OFFCRYPTO] section 2.3.6.2 or [MS-OFFCRYPTO] section 2.3.5.2 depending on the RC4 algorithm used. The record data is then **encrypted** by the specific RC4 algorithm in 1024-byte blocks. The block number is set to zero at the beginning of every BIFF record stream, and incremented by one at each 1024-byte boundary. Bytes to be encrypted are passed into the RC4 **encryption** function and then written to the stream. For unencrypted records and the record headers consisting of the record type and record size, a byte buffer of all zeros, of the same size as the section of unencrypted bytes, is passed into the RC4 **encryption** function. The results are then ignored and the unencrypted bytes are written to the stream.

See the [Security Considerations](#) section for information about security concerns relating to file **encryption** for this file format.

2.2.11 Shared Workbooks

The **shared workbook** infrastructure is used to enable multiple users to make changes to a **workbook** at the same time as well as track changes that certain users make. A **shared workbook** contains a collection of users that currently have the document open and a set of **revision logs** (section [2.2.11.2](#)) that contain the changes that users have made to the workbook. Each of these logs has a corresponding revision header associated with it and contains either a set of **revision records** (section [2.2.11.3](#)) that have been made to the **shared workbook** because it has been shared or no

revision records (section 2.2.11.3). A workbook is a **shared workbook** if and only if the **user names stream** (section 2.1.7.17) exists.

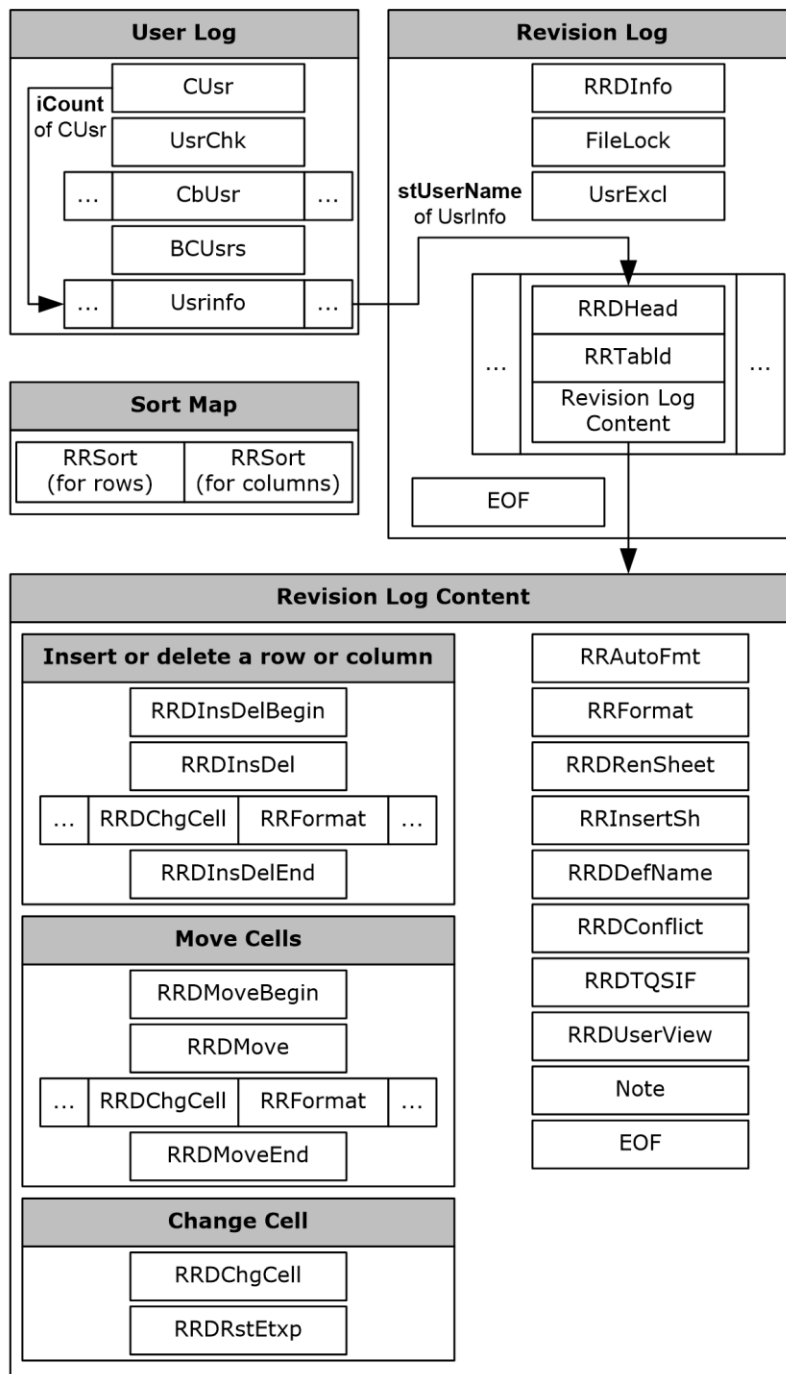

Figure 17: Structure of shared workbooks

The following sections define terms used in this diagram.

2.2.11.1 User Log

The **user log** contains the set of users who currently have the **workbook** open. The **iCount** field of **CUsr** (section [2.4.72](#)) specifies the number of **UsrInfo records** (section [2.4.340](#)) that this section contains. Each **UsrInfo** record (section [2.4.340](#)) corresponds to a user that currently has the workbook open. The **guid** field of the **UsrInfo maps** (section [2.4.340](#)) to the **guid** field of **RRDHead** (section [2.4.226](#)) that specifies which **revision log** (section [2.2.11.2](#)) the user is currently synchronized to.

2.2.11.2 Revision Logs

The revision **logs** section contains a set of revision **logs**. Each revision **log** contains various **revision records** (section [2.2.11.3](#)) that a single user has made to a **shared workbook** (section [2.2.11](#)) or a user action. Each revision **log** has a revision header (**RRDHead** (section [2.4.226](#))) and a tab identifier map (**RRTabId** (section [2.4.241](#))) that describes general information. The **stUserName** field of **RRDHead** (section [2.4.226](#)) is the name of the user who made changes or performed an action for that particular log. If the revision **log** is meant to describe user changes (and not a user action), it will also contain other revision **log** content that will describe all the changes made by that user. This **revision log stream ABNF** also contains general information about the **shared workbook** (section [2.2.11](#)) in **RRDInfo** (section [2.4.227](#)), **FileLock** (section [2.4.116](#)), and **UsrExcl** (section [2.4.339](#)).

2.2.11.3 Revision Records

A **revision record** describes changes, or revisions, that a single user has made to a **shared workbook** (section [2.2.11](#)). The following changes can be recorded by the **shared workbook** (section [2.2.11](#)):

- Inserting or deleting a row or column (**RRDInsDel** (section [2.4.228](#)))
- Moving a **cell** (**RRDMove** (section [2.4.231](#)))
- Changing a cell (**RRDChgCell** (section [2.4.223](#)))
- Adding or removing a **custom view** (**RRDUserView** (section [2.4.237](#)))
- Renaming an existing **sheet (1)** (**RRDRenSheet** (section [2.4.234](#)))
- Inserting a new sheet (1) (**RRInsertSh** (section [2.4.239](#)))
- Changing a **defined name** (**RRDDefName** (section [2.4.225](#)))
- Changing a **comment** (**Note** (section [2.4.179](#)))
- Conflict resolution from previous conflicting changes (**RRDConflict** (section [2.4.224](#)))
- Removing a **query table** (**RRDTSIF** (section [2.4.236](#)))
- Changing the format (**RRFormat** (section [2.4.238](#)))
- Changing the **AutoFormat** information for a **table** (**RRAutoFmt** (section [2.4.222](#)))

2.2.11.4 Insertion / Deletion of Rows / Columns Revision

This revision corresponds to an insertion or deletion of a row or column. In between **RRDInsDel** (section [2.4.228](#)) and **RRDInsDelEnd** (section [2.4.230](#)), any number of **RRFormat** (section [2.4.238](#)) and **RRDChgCell records** (section [2.4.223](#)) can appear as well as the other records associated with **RRDChgCell** (section [2.4.223](#)) (**RRDRstEtxp** (section [2.4.235](#))). These records describe the **cell** and format changes as a result of inserting or deleting the row or column.

2.2.11.5 Move Cells Revision

This revision corresponds to moving a **range** of **cells**. In between **RRDMove** (section [2.4.231](#)) and **RRDMoveEnd** (section [2.4.233](#)), any number of **RRFormat** (section [2.4.238](#)) and **RRDChgCell records** (section [2.4.223](#)) can appear as well as the other records associated with **RRDChgCell** (section [2.4.223](#)) (**RRDRstEtxp** (section [2.4.235](#))). These records describe the cell and format changes as a result of moving a range of cells.

2.2.11.6 Change Cells Revision

This revision (**RRDChgCell** (section [2.4.223](#))) corresponds to a change or edit of a **cell**. It can be followed by any number of **RRDRstEtxp records** (section [2.4.235](#)). These specify **font** information for the **formatting run** as specified in **RRDChgCell** (section [2.4.223](#)).

2.2.11.7 Sort Map

The **Sort Map** contains changes to sorting done on the **sheet (1)** level in a **shared workbook** (section [2.2.11](#)). Each sheet (1) can have a **Sort Map**. The **Sort Map** is made of up to two sorts (**RRSort** (section [2.4.240](#))). One specifies sheet (1) level sort changes in rows followed by sheet (1) level sort changes in columns. If there are no changes in sort for rows or columns, the sort map does not exist for rows or columns respectively.

2.2.12 Shared Feature

A **shared feature** is a mechanism that enables different application features to share a common set of record types. For an enumeration of the types of **shared features**, see **SharedFeatureType** (section [2.5.237](#)). For each type of **shared feature** the required records vary. All **shared features** use the following:

- Common information stored in a **FeatHdr** (section [2.4.112](#)) or **FeatHdr11** (section [2.4.113](#)) record. There MUST be one **FeatHdr** (section [2.4.112](#)) or **FeatHdr11** (section [2.4.113](#)) record for each type of **shared feature** used in one of the **Workbook substreams** (section [2.1.7.20](#)).
- Instance specific feature data stored in a **Feat** (section [2.4.111](#)), **Feature11** (section [2.4.114](#)), or **Feature12** (section [2.4.115](#)) record. There MUST be one or more **Feat** (section [2.4.111](#)), **Feature11** (section [2.4.114](#)), or **Feature12** (section [2.4.115](#)) records for each instance of a **shared feature**.

Some **shared features** require other feature-specific records. See **FEAT** (section [2.1.7.20.6](#)) and **FEAT11** (section [2.1.7.20.6](#)) records for additional records used for **shared features**.

2.3 Record Enumeration

This section specifies the record name associated with a given record type value. For more information about record types, see the section on **Records** (section [2.1.4](#)).

These associations between record name and record type are listed by record name as well as by record type.

The type-specific meaning and fields for each record type are specified in the subsection of the **Records section** (section [2.4](#)) corresponding to the record name.

2.3.1 By Name

Name	Record type (number)
AlRuns (section 2.4.1)	4176
Area (section 2.4.2)	4122
AreaFormat (section 2.4.3)	4106
Array (section 2.4.4)	545
AttachedLabel (section 2.4.5)	4108
AutoFilter (section 2.4.6)	158
AutoFilter12 (section 2.4.7)	2174
AutoFilterInfo (section 2.4.8)	157
AxcExt (section 2.4.9)	4194
AxesUsed (section 2.4.10)	4166
Axis (section 2.4.11)	4125
AxisLine (section 2.4.12)	4129
AxisParent (section 2.4.13)	4161
Backup (section 2.4.14)	64
Bar (section 2.4.15)	4119
BCUsrs (section 2.4.16)	407
Begin (section 2.4.17)	4147
BigName (section 2.4.18)	1048
BkHim (section 2.4.19)	233
Blank (section 2.4.20)	513
BOF (section 2.4.21)	2057
BookBool (section 2.4.22)	218
BookExt (section 2.4.23)	2147
BoolErr (section 2.4.24)	517
BopPop (section 2.4.25)	4193
BopPopCustom (section 2.4.26)	4199
BottomMargin (section 2.4.27)	41
BoundSheet8 (section 2.4.28)	133
BRAI (section 2.4.29)	4177
BuiltInFnGroupCount (section 2.4.30)	156

Name	Record type (number)
CalcCount (section 2.4.31)	12
CalcDelta (section 2.4.32)	16
CalcIter (section 2.4.33)	17
CalcMode (section 2.4.34)	13
CalcPrecision (section 2.4.35)	14
CalcRefMode (section 2.4.36)	15
CalcSaveRecalc (section 2.4.37)	95
CatLab (section 2.4.38)	2134
CatSerRange (section 2.4.39)	4128
CbUsr (section 2.4.40)	402
CellWatch (section 2.4.41)	2156
CF (section 2.4.42)	433
CF12 (section 2.4.43)	2170
CFEx (section 2.4.44)	2171
Chart (section 2.4.45)	4098
Chart3d (section 2.4.46)	4154
Chart3DBarShape (section 2.4.47)	4191
ChartFormat (section 2.4.48)	4116
ChartFrtInfo (section 2.4.49)	2128
ClrtClient (section 2.4.50)	4188
CodeName (section 2.4.51)	442
CodePage (section 2.4.52)	66
ColInfo (section 2.4.53)	125
Compat12 (section 2.4.54)	2188
CompressPictures (section 2.4.55)	2203
CondFmt (section 2.4.56)	432
CondFmt12 (section 2.4.57)	2169
Continue (section 2.4.58)	60
ContinueBigName (section 2.4.59)	1084
ContinueFrt (section 2.4.60)	2066
ContinueFrt11 (section 2.4.61)	2165

Name	Record type (number)
ContinueFrt12 (section 2.4.62)	2175
Country (section 2.4.63)	140
CrErr (section 2.4.64)	2149
CRN (section 2.4.65)	90
CrtLayout12 (section 2.4.66)	2205
CrtLayout12A (section 2.4.67)	2215
CrtLine (section 2.4.68)	4124
CrtLink (section 2.4.69)	4130
CrtMIFrt (section 2.4.70)	2206
CrtMIFrtContinue (section 2.4.71)	2207
CUsr (section 2.4.72)	401
Dat (section 2.4.73)	4195
DataFormat (section 2.4.74)	4102
DataLabExt (section 2.4.75)	2154
DataLabExtContents (section 2.4.76)	2155
Date1904 (section 2.4.77)	34
DBCcell (section 2.4.78)	215
DbOrParamQry (section 2.4.79)	220
DBQueryExt (section 2.4.81)	2051
DCon (section 2.4.82)	80
DconBin (section 2.4.83)	437
DConn (section 2.4.84)	2166
DConName (section 2.4.85)	82
DConRef (section 2.4.86)	81
DefaultRowHeight (section 2.4.87)	549
DefaultText (section 2.4.88)	4132
DefColWidth (section 2.4.89)	85
Dimensions (section 2.4.90)	512
DocRoute (section 2.4.91)	184
DropBar (section 2.4.92)	4157
DropDownObjIds (section 2.4.93)	2164

Name	Record type (number)
DSF (section 2.4.94)	353
Dv (section 2.4.95)	446
DVal (section 2.4.96)	434
DXF (section 2.4.97)	2189
DxGCol (section 2.4.98)	153
End (section 2.4.99)	4148
EndBlock (section 2.4.100)	2131
EndObject (section 2.4.101)	2133
EntExU2 (section 2.4.102)	450
EOF (section 2.4.103)	10
Excel9File (section 2.4.104)	448
ExternName (section 2.4.105)	35
ExternSheet (section 2.4.106)	23
ExtSST (section 2.4.107)	255
ExtString (section 2.4.108)	2052
Fbi (section 2.4.109)	4192
Fbi2 (section 2.4.110)	4200
Feat (section 2.4.111)	2152
FeatHdr (section 2.4.112)	2151
FeatHdr11 (section 2.4.113)	2161
Feature11 (section 2.4.114)	2162
Feature12 (section 2.4.115)	2168
FileLock (section 2.4.116)	405
FilePass (section 2.4.117)	47
FileSharing (section 2.4.118)	91
FilterMode (section 2.4.119)	155
FnGroupName (section 2.4.120)	154
FnGrp12 (section 2.4.121)	2200
Font (section 2.4.122)	49
FontX (section 2.4.123)	4134
Footer (section 2.4.124)	21

Name	Record type (number)
ForceFullCalculation (section 2.4.125)	2211
Format (section 2.4.126)	1054
Formula (section 2.4.127)	6
Frame (section 2.4.128)	4146
FrntFontList (section 2.4.129)	2138
FrntWrapper (section 2.4.130)	2129
GelFrame (section 2.4.131)	4198
GridSet (section 2.4.132)	130
GUIDTypeLib (section 2.4.133)	2199
Guts (section 2.4.134)	128
HCenter (section 2.4.135)	131
Header (section 2.4.136)	20
HeaderFooter (section 2.4.137)	2204
HFPicture (section 2.4.138)	2150
HideObj (section 2.4.139)	141
HLink (section 2.4.140)	440
HLinkTooltip (section 2.4.141)	2048
HorizontalPageBreaks (section 2.4.142)	27
IFmtRecord (section 2.4.143)	4174
Index (section 2.4.144)	523
InterfaceEnd (section 2.4.145)	226
InterfaceHdr (section 2.4.146)	225
Intl (section 2.4.147)	97
Label (section 2.4.148)	516
LabelSst (section 2.4.149)	253
Lbl (section 2.4.150)	24
LeftMargin (section 2.4.151)	38
Legend (section 2.4.152)	4117
LegendException (section 2.4.153)	4163
Lel (section 2.4.154)	441
Line (section 2.4.155)	4120

Name	Record type (number)
LineFormat (section 2.4.156)	4103
List12 (section 2.4.157)	2167
LPr (section 2.4.158)	152
LRng (section 2.4.159)	351
MarkerFormat (section 2.4.160)	4105
MDB (section 2.4.161)	2186
MDTInfo (section 2.4.162)	2180
MDXKPI (section 2.4.163)	2185
MDXProp (section 2.4.164)	2184
MDXSet (section 2.4.165)	2183
MDXStr (section 2.4.166)	2181
MDXTuple (section 2.4.167)	2182
MergeCells (section 2.4.168)	229
Mms (section 2.4.169)	193
MsoDrawing (section 2.4.170)	236
MsoDrawingGroup (section 2.4.171)	235
MsoDrawingSelection (section 2.4.172)	237
MTRSettings (section 2.4.173)	2202
MulBlank (section 2.4.174)	190
MulRk (section 2.4.175)	189
NameCmt (section 2.4.176)	2196
NameFnGrp12 (section 2.4.177)	2201
NamePublish (section 2.4.178)	2195
Note (section 2.4.179)	28
Number (section 2.4.180)	515
Obj (section 2.4.181)	93
ObjectLink (section 2.4.182)	4135
ObjProtect (section 2.4.183)	99
ObNoMacros (section 2.4.184)	445
ObProj (section 2.4.185)	211
OleDbConn (section 2.4.186)	2058

Name	Record type (number)
OleObjectSize (section 2.4.187)	222
Palette (section 2.4.188)	146
Pane (section 2.4.189)	65
Password (section 2.4.191)	19
PhoneticInfo (section 2.4.192)	239
PicF (section 2.4.193)	4156
Pie (section 2.4.194)	4121
PieFormat (section 2.4.195)	4107
PivotChartBits (section 2.4.196)	2137
PlotArea (section 2.4.197)	4149
PlotGrowth (section 2.4.198)	4196
Pls (section 2.4.199)	77
PLV (section 2.4.200)	2187
Pos (section 2.4.201)	4175
PrintGrid (section 2.4.202)	43
PrintRowCol (section 2.4.203)	42
PrintSize (section 2.4.204)	51
Prot4Rev (section 2.4.205)	431
Prot4RevPass (section 2.4.206)	444
Protect (section 2.4.207)	18
Qsi (section 2.4.208)	429
Qsif (section 2.4.209)	2055
Qsir (section 2.4.210)	2054
QsiSXTag (section 2.4.211)	2050
Radar (section 2.4.212)	4158
RadarArea (section 2.4.213)	4160
RealTimeData (section 2.4.214)	2067
RecalcId (section 2.4.215)	449
RecipName (section 2.4.216)	185
RefreshAll (section 2.4.217)	439
RichTextStream (section 2.4.218)	2214

Name	Record type (number)
RightMargin (section 2.4.219)	39
RK (section 2.4.220)	638
Row (section 2.4.221)	520
RRAutoFmt (section 2.4.222)	331
RRDChgCell (section 2.4.223)	315
RRDConflict (section 2.4.224)	338
RRDDefName (section 2.4.225)	339
RRDHead (section 2.4.226)	312
RRDInfo (section 2.4.227)	406
RRDInsDel (section 2.4.228)	311
RRDInsDelBegin (section 2.4.229)	336
RRDInsDelEnd (section 2.4.230)	337
RRDMove (section 2.4.231)	320
RRDMoveBegin (section 2.4.232)	334
RRDMoveEnd (section 2.4.233)	335
RRDRenSheet (section 2.4.234)	318
RRDRstEtxp (section 2.4.235)	340
RRDTQSIF (section 2.4.236)	2056
RRDUserView (section 2.4.237)	428
RRFormat (section 2.4.238)	330
RRInsertSh (section 2.4.239)	333
RRSort (section 2.4.240)	319
RRTabId (section 2.4.241)	317
SBaseRef (section 2.4.242)	4168
Scatter (section 2.4.243)	4123
SCENARIO (section 2.4.244)	175
ScenarioProtect (section 2.4.245)	221
ScenMan (section 2.4.246)	174
Scl (section 2.4.247)	160
Selection (section 2.4.248)	29
SerAuxErrBar (section 2.4.249)	4187

Name	Record type (number)
SerAuxTrend (section 2.4.250)	4171
SerFmt (section 2.4.251)	4189
Series (section 2.4.252)	4099
SeriesList (section 2.4.253)	4118
SeriesText (section 2.4.254)	4109
SerParent (section 2.4.255)	4170
SerToCrt (section 2.4.256)	4165
Setup (section 2.4.257)	161
ShapePropsStream (section 2.4.258)	2212
SheetExt (section 2.4.259)	2146
ShrFmla (section 2.4.260)	1212
ShtProps (section 2.4.261)	4164
SIIndex (section 2.4.262)	4197
Sort (section 2.4.263)	144
SortData (section 2.4.264)	2197
SST (section 2.4.265)	252
StartBlock (section 2.4.266)	2130
StartObject (section 2.4.267)	2132
String (section 2.4.268)	519
Style (section 2.4.269)	659
StyleExt (section 2.4.270)	2194
SupBook (section 2.4.271)	430
Surf (section 2.4.272)	4159
SXAddl (section 2.4.273)	2148
SxBool (section 2.4.274)	202
SXDB (section 2.4.275)	198
SXDBB (section 2.4.276)	200
SXDBEx (section 2.4.277)	290
SXDI (section 2.4.278)	197
SXDtr (section 2.4.279)	206
SxDXF (section 2.4.280)	244

Name	Record type (number)
SxErr (section 2.4.281)	203
SXEx (section 2.4.282)	241
SXFDB (section 2.4.283)	199
SXFDBType (section 2.4.284)	443
SxFilt (section 2.4.285)	242
SxFmla (section 2.4.286)	249
SxFormat (section 2.4.287)	251
SXFormula (section 2.4.288)	259
SXInt (section 2.4.289)	204
SxIsxoper (section 2.4.290)	217
SxItm (section 2.4.291)	245
SxIvd (section 2.4.292)	180
SXLI (section 2.4.293)	181
SxName (section 2.4.294)	246
SxNil (section 2.4.295)	207
SXNum (section 2.4.296)	201
SXPair (section 2.4.297)	248
SXPI (section 2.4.298)	182
SXPIEx (section 2.4.299)	2062
SXRng (section 2.4.300)	216
SxRule (section 2.4.301)	240
SxSelect (section 2.4.302)	247
SXStreamID (section 2.4.303)	213
SXString (section 2.4.304)	205
SXTbl (section 2.4.305)	208
SxTbpg (section 2.4.306)	210
SXTBRGIITM (section 2.4.307)	209
SXTH (section 2.4.308)	2061
Sxvd (section 2.4.309)	177
SXVDEx (section 2.4.310)	256
SXVDTEx (section 2.4.311)	2063

Name	Record type (number)
SXVI (section 2.4.312)	178
SxView (section 2.4.313)	176
SXViewEx (section 2.4.314)	2060
SXViewEx9 (section 2.4.315)	2064
SXViewLink (section 2.4.316)	2136
SXVS (section 2.4.317)	227
Sync (section 2.4.318)	151
Table (section 2.4.319)	566
TableStyle (section 2.4.320)	2191
TableStyleElement (section 2.4.321)	2192
TableStyles (section 2.4.322)	2190
Template (section 2.4.323)	96
Text (section 2.4.324)	4133
TextPropsStream (section 2.4.325)	2213
Theme (section 2.4.326)	2198
Tick (section 2.4.327)	4126
TopMargin (section 2.4.328)	40
TxO (section 2.4.329)	438
TxtQry (section 2.4.330)	2053
Uncalcd (section 2.4.331)	94
Units (section 2.4.332)	4097
UserBView (section 2.4.333)	425
UserSViewBegin (section 2.4.334)	426
UserSViewBegin_Chart (section 2.4.335)	426
UserSViewEnd (section 2.4.336)	427
UsesELFs (section 2.4.337)	352
UsrChk (section 2.4.338)	408
UsrExcl (section 2.4.339)	404
UsrInfo (section 2.4.340)	403
ValueRange (section 2.4.341)	4127
VCenter (section 2.4.342)	132

Name	Record type (number)
VerticalPageBreaks (section 2.4.343)	26
WebPub (section 2.4.344)	2049
Window1 (section 2.4.345)	61
Window2 (section 2.4.346)	574
WinProtect (section 2.4.347)	25
WOpt (section 2.4.348)	2059
WriteAccess (section 2.4.349)	92
WriteProtect (section 2.4.350)	134
WsBool (section 2.4.351)	129
XCT (section 2.4.352)	89
XF (section 2.4.353)	224
XFCRC (section 2.4.354)	2172
XFExt (section 2.4.355)	2173
YMult (section 2.4.356)	2135

2.3.2 By Number

Name	Record type (number)
Formula (section 2.4.127)	6
EOF (section 2.4.103)	10
CalcCount (section 2.4.31)	12
CalcMode (section 2.4.34)	13
CalcPrecision (section 2.4.35)	14
CalcRefMode (section 2.4.36)	15
CalcDelta (section 2.4.32)	16
CalcIter (section 2.4.33)	17
Protect (section 2.4.207)	18
Password (section 2.4.191)	19
Header (section 2.4.136)	20
Footer (section 2.4.124)	21

ExternSheet (section 2.4.106)	23
Lbl (section 2.4.150)	24
WinProtect (section 2.4.347)	25
VerticalPageBreaks (section 2.4.343)	26
HorizontalPageBreaks (section 2.4.142)	27
Note (section 2.4.179)	28
Selection (section 2.4.248)	29
Date1904 (section 2.4.77)	34
ExternName (section 2.4.105)	35
LeftMargin (section 2.4.151)	38
RightMargin (section 2.4.219)	39
TopMargin (section 2.4.328)	40
BottomMargin (section 2.4.27)	41
PrintRowCol (section 2.4.203)	42
PrintGrid (section 2.4.202)	43
FilePass (section 2.4.117)	47
Font (section 2.4.122)	49
PrintSize (section 2.4.204)	51
Continue (section 2.4.58)	60
Window1 (section 2.4.345)	61
Backup (section 2.4.14)	64
Pane (section 2.4.189)	65
CodePage (section 2.4.52)	66
Pls (section 2.4.199)	77
DCon (section 2.4.82)	80
DConRef (section 2.4.86)	81
DConName (section 2.4.85)	82
DefColWidth (section 2.4.89)	85
XCT (section 2.4.352)	89
CRN (section 2.4.65)	90
FileSharing (section 2.4.118)	91
WriteAccess (section 2.4.349)	92
Obj (section 2.4.181)	93

Uncalced (section 2.4.331)	94
CalcSaveRecalc (section 2.4.37)	95
Template (section 2.4.323)	96
Intl (section 2.4.147)	97
ObjProtect (section 2.4.183)	99
ColInfo (section 2.4.53)	125
Guts (section 2.4.134)	128
WsBool (section 2.4.351)	129
GridSet (section 2.4.132)	130
HCenter (section 2.4.135)	131
VCenter (section 2.4.342)	132
BoundSheet8 (section 2.4.28)	133
WriteProtect (section 2.4.350)	134
Country (section 2.4.63)	140
HideObj (section 2.4.139)	141
Sort (section 2.4.263)	144
Palette (section 2.4.188)	146
Sync (section 2.4.318)	151
LPr (section 2.4.158)	152
DxGCol (section 2.4.98)	153
FnGroupName (section 2.4.120)	154
FilterMode (section 2.4.119)	155
BuiltInFnGroupCount (section 2.4.30)	156
AutoFilterInfo (section 2.4.8)	157
AutoFilter (section 2.4.6)	158
Scl (section 2.4.247)	160
Setup (section 2.4.257)	161
ScenMan (section 2.4.246)	174
SCENARIO (section 2.4.244)	175
SxView (section 2.4.313)	176
Sxvd (section 2.4.309)	177
SXVI (section 2.4.312)	178
SxIvd (section 2.4.292)	180

SXLI (section 2.4.293)	181
SXPI (section 2.4.298)	182
DocRoute (section 2.4.91)	184
RecipName (section 2.4.216)	185
MulRk (section 2.4.175)	189
MulBlank (section 2.4.174)	190
Mms (section 2.4.169)	193
SXDI (section 2.4.278)	197
SXDB (section 2.4.275)	198
SXFDB (section 2.4.283)	199
SXDBB (section 2.4.276)	200
SXNum (section 2.4.296)	201
SxBool (section 2.4.274)	202
SxErr (section 2.4.281)	203
SXInt (section 2.4.289)	204
SXString (section 2.4.304)	205
SXDtr (section 2.4.279)	206
SxNil (section 2.4.295)	207
SXTbl (section 2.4.305)	208
SXTBrgiitm (section 2.4.307)	209
SxTbpg (section 2.4.306)	210
ObProj (section 2.4.185)	211
SXStreamID (section 2.4.303)	213
DBCcell (section 2.4.78)	215
SXRng (section 2.4.300)	216
SxIsxoper (section 2.4.290)	217
BookBool (section 2.4.22)	218
DbOrParamQry (section 2.4.79)	220
ScenarioProtect (section 2.4.245)	221
OleObjectSize (section 2.4.187)	222
XF (section 2.4.353)	224
InterfaceHdr (section 2.4.146)	225
InterfaceEnd (section 2.4.145)	226

SXVS (section 2.4.317)	227
MergeCells (section 2.4.168)	229
BkHim (section 2.4.19)	233
MsoDrawingGroup (section 2.4.171)	235
MsoDrawing (section 2.4.170)	236
MsoDrawingSelection (section 2.4.172)	237
PhoneticInfo (section 2.4.192)	239
SxRule (section 2.4.301)	240
SXEx (section 2.4.282)	241
SxFilt (section 2.4.285)	242
SxDXF (section 2.4.280)	244
SxItm (section 2.4.291)	245
SxName (section 2.4.294)	246
SxSelect (section 2.4.302)	247
SXPair (section 2.4.297)	248
SxFmla (section 2.4.286)	249
SxFormat (section 2.4.287)	251
SST (section 2.4.265)	252
LabelSst (section 2.4.149)	253
ExtSST (section 2.4.107)	255
SXVDEx (section 2.4.310)	256
SXFormula (section 2.4.288)	259
SXDBEx (section 2.4.277)	290
RRDInsDel (section 2.4.228)	311
RRDHead (section 2.4.226)	312
RRDChgCell (section 2.4.223)	315
RRTabId (section 2.4.241)	317
RRDRenSheet (section 2.4.234)	318
RRSort (section 2.4.240)	319
RRDMove (section 2.4.231)	320
RRFormat (section 2.4.238)	330
RRAutoFmt (section 2.4.222)	331
RRInsertSh (section 2.4.239)	333

RRDMoveBegin (section 2.4.232)	334
RRDMoveEnd (section 2.4.233)	335
RRDInsDelBegin (section 2.4.229)	336
RRDInsDelEnd (section 2.4.230)	337
RRDConflict (section 2.4.224)	338
RRDDefName (section 2.4.225)	339
RRDRstEtxp (section 2.4.235)	340
LRng (section 2.4.159)	351
UsesELFs (section 2.4.337)	352
DSF (section 2.4.94)	353
CUsr (section 2.4.72)	401
CbUsr (section 2.4.40)	402
UsrInfo (section 2.4.340)	403
UsrExcl (section 2.4.339)	404
FileLock (section 2.4.116)	405
RRDInfo (section 2.4.227)	406
BCUsrs (section 2.4.16)	407
UsrChk (section 2.4.338)	408
UserBView (section 2.4.333)	425
UserSViewBegin (section 2.4.334)	426
UserSViewBegin_Chart (section 2.4.335)	426
UserSViewEnd (section 2.4.336)	427
RRDUserView (section 2.4.237)	428
Qsi (section 2.4.208)	429
SupBook (section 2.4.271)	430
Prot4Rev (section 2.4.205)	431
CondFmt (section 2.4.56)	432
CF (section 2.4.42)	433
DVal (section 2.4.96)	434
DConBin (section 2.4.83)	437
TxO (section 2.4.329)	438
RefreshAll (section 2.4.217)	439
HLink (section 2.4.140)	440

Lel (section 2.4.154)	441
CodeName (section 2.4.51)	442
SXFDBType (section 2.4.284)	443
Prot4RevPass (section 2.4.206)	444
ObNoMacros (section 2.4.184)	445
Dv (section 2.4.95)	446
Excel9File (section 2.4.104)	448
RecalcId (section 2.4.215)	449
EntExU2 (section 2.4.102)	450
Dimensions (section 2.4.90)	512
Blank (section 2.4.20)	513
Number (section 2.4.180)	515
Label (section 2.4.148)	516
BoolErr (section 2.4.24)	517
String (section 2.4.268)	519
Row (section 2.4.221)	520
Index (section 2.4.144)	523
Array (section 2.4.4)	545
DefaultRowHeight (section 2.4.87)	549
Table (section 2.4.319)	566
Window2 (section 2.4.346)	574
RK (section 2.4.220)	638
Style (section 2.4.269)	659
BigName (section 2.4.18)	1048
Format (section 2.4.126)	1054
ContinueBigName (section 2.4.59)	1084
ShrFmla (section 2.4.260)	1212
HLinkTooltip (section 2.4.141)	2048
WebPub (section 2.4.344)	2049
QsiSXTag (section 2.4.211)	2050
DBQueryExt (section 2.4.81)	2051
ExtString (section 2.4.108)	2052
TxtQry (section 2.4.330)	2053

Qsir (section 2.4.210)	2054
Qsif (section 2.4.209)	2055
RRDTQSIF (section 2.4.236)	2056
BOF (section 2.4.21)	2057
OleDbConn (section 2.4.186)	2058
WOpt (section 2.4.348)	2059
SXViewEx (section 2.4.314)	2060
SXTH (section 2.4.308)	2061
SXPIEx (section 2.4.299)	2062
SXVDTEEx (section 2.4.311)	2063
SXViewEx9 (section 2.4.315)	2064
ContinueFrt (section 2.4.60)	2066
RealTimeData (section 2.4.214)	2067
ChartFrtInfo (section 2.4.49)	2128
FrtWrapper (section 2.4.130)	2129
StartBlock (section 2.4.266)	2130
EndBlock (section 2.4.100)	2131
StartObject (section 2.4.267)	2132
EndObject (section 2.4.101)	2133
CatLab (section 2.4.38)	2134
YMult (section 2.4.356)	2135
SXViewLink (section 2.4.316)	2136
PivotChartBits (section 2.4.196)	2137
FrtFontList (section 2.4.129)	2138
SheetExt (section 2.4.259)	2146
BookExt (section 2.4.23)	2147
SXAddI (section 2.4.273.2)	2148
CrErr (section 2.4.64)	2149
HFPicture (section 2.4.138)	2150
FeatHdr (section 2.4.112)	2151
Feat (section 2.4.111)	2152
DataLabExt (section 2.4.75)	2154
DataLabExtContents (section 2.4.76)	2155

CellWatch (section 2.4.41)	2156
FeatHdr11 (section 2.4.113)	2161
Feature11 (section 2.4.114)	2162
DropDownObjIds (section 2.4.93)	2164
ContinueFrt11 (section 2.4.61)	2165
DConn (section 2.4.84)	2166
List12 (section 2.4.157)	2167
Feature12 (section 2.4.115)	2168
CondFmt12 (section 2.4.57)	2169
CF12 (section 2.4.43)	2170
CFEx (section 2.4.44)	2171
XFCRC (section 2.4.354)	2172
XFExt (section 2.4.355)	2173
AutoFilter12 (section 2.4.7)	2174
ContinueFrt12 (section 2.4.62)	2175
MDTInfo (section 2.4.162)	2180
MDXStr (section 2.4.166)	2181
MDXTuple (section 2.4.167)	2182
MDXSet (section 2.4.165)	2183
MDXProp (section 2.4.164)	2184
MDXKPI (section 2.4.163)	2185
MDB (section 2.4.161)	2186
PLV (section 2.4.200)	2187
Compat12 (section 2.4.54)	2188
DXF (section 2.4.97)	2189
TableStyles (section 2.4.322)	2190
TableStyle (section 2.4.320)	2191
TableStyleElement (section 2.4.321)	2192
StyleExt (section 2.4.270)	2194
NamePublish (section 2.4.178)	2195
NameCmt (section 2.4.176)	2196
SortData (section 2.4.264)	2197
Theme (section 2.4.326)	2198

GUIDTypeLib (section 2.4.133)	2199
FnGrp12 (section 2.4.121)	2200
NameFnGrp12 (section 2.4.177)	2201
MTRSettings (section 2.4.173)	2202
CompressPictures (section 2.4.55)	2203
HeaderFooter (section 2.4.137)	2204
CrtLayout12 (section 2.4.66)	2205
CrtMIFrt (section 2.4.70)	2206
CrtMIFrtContinue (section 2.4.71)	2207
ForceFullCalculation (section 2.4.125)	2211
ShapePropsStream (section 2.4.258)	2212
TextPropsStream (section 2.4.325)	2213
RichTextStream (section 2.4.218)	2214
CrtLayout12A (section 2.4.67)	2215
Units (section 2.4.332)	4097
Chart (section 2.4.45)	4098
Series (section 2.4.252)	4099
DataFormat (section 2.4.74)	4102
LineFormat (section 2.4.156)	4103
MarkerFormat (section 2.4.160)	4105
AreaFormat (section 2.4.3)	4106
PieFormat (section 2.4.195)	4107
AttachedLabel (section 2.4.5)	4108
SeriesText (section 2.4.254)	4109
ChartFormat (section 2.4.48)	4116
Legend (section 2.4.152)	4117
SeriesList (section 2.4.253)	4118
Bar (section 2.4.15)	4119
Line (section 2.4.155)	4120
Pie (section 2.4.194)	4121
Area (section 2.4.2)	4122
Scatter (section 2.4.243)	4123
CrtLine (section 2.4.68)	4124

Axis (section 2.4.11)	4125
Tick (section 2.4.327)	4126
ValueRange (section 2.4.341)	4127
CatSerRange (section 2.4.39)	4128
AxisLine (section 2.4.12)	4129
CrtLink (section 2.4.69)	4130
DefaultText (section 2.4.88)	4132
Text (section 2.4.324)	4133
FontX (section 2.4.123)	4134
ObjectLink (section 2.4.182)	4135
Frame (section 2.4.128)	4146
Begin (section 2.4.17)	4147
End (section 2.4.99)	4148
PlotArea (section 2.4.197)	4149
Chart3d (section 2.4.46)	4154
PicF (section 2.4.193)	4156
DropBar (section 2.4.92)	4157
Radar (section 2.4.212)	4158
Surf (section 2.4.272)	4159
RadarArea (section 2.4.213)	4160
AxisParent (section 2.4.13)	4161
LegendException section 2.4.153 ()	4163
ShtProps (section 2.4.261)	4164
SerToCrt (section 2.4.256)	4165
AxesUsed (section 2.4.10)	4166
SBaseRef (section 2.4.242)	4168
SerParent (section 2.4.255)	4170
SerAuxTrend (section 2.4.250)	4171
IFmtRecord (section 2.4.143)	4174
Pos (section 2.4.201)	4175
AIRuns (section 2.4.1)	4176
BRAI (section 2.4.29)	4177
SerAuxErrBar (section 2.4.249)	4187

ClrtClient (section 2.4.50)	4188
SerFmt (section 2.4.251)	4189
Chart3DBarShape (section 2.4.47)	4191
Fbi (section 2.4.109)	4192
BopPop (section 2.4.25)	4193
AxcExt (section 2.4.9)	4194
Dat (section 2.4.73)	4195
PlotGrowth (section 2.4.198)	4196
SIIndex (section 2.4.262)	4197
GelFrame (section 2.4.131)	4198
BopPopCustom (section 2.4.26)	4199
Fbi2 (section 2.4.110)	4200

2.4 Records

2.4.1 AIRuns

The **AIRuns** record specifies Rich Text Formatting within **chart titles** (section [2.2.3.3](#)), **trendline** (section [2.2.3.12](#)), and **data labels** (section [2.2.3.11](#)).

0	1	2	3	4	5	6	7	8	9	10	1	2	3	4	5	6	7	8	9	20	1	2	3	4	5	6	7	8	9	30	1		
cRuns											rgRuns (variable)																						
...																																	

cRuns (2 bytes): An unsigned integer that specifies the number of Rich Text Format runs. MUST be greater than or equal to 3 and less than or equal to 256.

rgRuns (variable): An array of **FormatRun structures** (section [2.5.132](#)) that specifies the Rich Text Format runs. The number of elements in the array MUST be equal to **cRuns**.

2.4.2 Area

The **Area** record specifies that the **chart group** (section [2.2.3.7](#)) is an area **chart group** (section [2.2.3.7](#)) and specifies the **chart group** (section [2.2.3.7](#)) attributes.

0	1	2	3	4	5	6	7	8	9	10	1	2	3	4	5	6	7	8	9	20	1	2	3	4	5	6	7	8	9	30	1
A	B	C	reserved																												

A - fStacked (1 bit): A bit that specifies whether the **data points** (section [2.2.3.10](#)) in the **chart group** (section [2.2.3.7](#)) that share the same **category (2)** are stacked.

B - f100 (1 bit): A bit that specifies whether the **data points** (section 2.2.3.10) in the **chart group** (section 2.2.3.7) are displayed as a percentage of the sum of all **data points** (section 2.2.3.10) in the **chart group** (section 2.2.3.7) that share the same category (2). MUST be 0 if **fStacked** is 0.

C - fHasShadow (1 bit): A bit that specifies whether one or more **data points** (section 2.2.3.10) in the **chart group** (section 2.2.3.7) has shadows.

reserved (13 bits): MUST be zero, and MUST be ignored.

2.4.3 AreaFormat

The **AreaFormat** record specifies the patterns and colors used in a filled region of a **chart** (section 2.2.3.3). If this record is not present in the sequence of records that conforms to the **SS rule** (section 2.1.7.20.1) of the Chart Sheet Substream **ABNF**, the patterns and colors used are specified by the default values of the fields of this record.











0	1	2	3	4	5	6	7	8	9	10	11	12	13	14	15	16	17	18	19	20	21	22	23	24	25	26	27	28	29	30	31
rgbFore																															
rgbBack																															
fls																A	B	reserved													
icvFore																icvBack															











rgbFore (4 bytes): A **LongRGB structure** (section 2.5.177) that specifies the **foreground color** of the **fill pattern**.<23> The default value of this field is automatically selected from the next available color in the **chart** (section 2.2.3.3) color table.













rgbBack (4 bytes): A **LongRGB structure** (section 2.5.177) that specifies the **background color** of the fill pattern.<24> The default value of this field is 0xFFFFFFFF.











fls (2 bytes): An unsigned integer that specifies the type of fill pattern. If **fls** is neither 0x0000 nor 0x0001, this record MUST be immediately followed by a corresponding **GelFrame** record (section 2.4.131) that specifies the fill pattern. The fillType as specified in [MS-ODRAW] section 2.3.7.1 of the **OPT1** field of the corresponding **GelFrame** record (section 2.4.131) MUST be **msofillPattern** as specified in [MS-ODRAW] section 2.4.11. The default value of this field is 0x0001. **fls** MUST be a value from the following table:



Value	Meaning
0x0000	The fill pattern is none (no fill). When rgbFore or rgbBack are specified, a pattern of 'none' overrides and means there is no fill.
0x0001	The fill pattern is solid. When solid is specified, rgbFore is the only color rendered, even when rgbBack is also specified.
0x0002	The fill pattern is medium gray. Additional properties in the corresponding GelFrame record (section 2.4.131) specify which of the following gray patterns is used.  Percent50 - Specifies a 50 percent hatch. The ratio of foreground color to background color is 50:100.
0x0003	The fill pattern is dark gray. Additional properties in the corresponding GelFrame record (section 2.4.131) specify which of the following dark gray patterns is used.

Value	Meaning
	 Percent60 - Specifies a 60 percent hatch. The ratio of foreground color to background color is 60:100.  Percent70 - Specifies a 70 percent hatch. The ratio of foreground color to background color is 70:100.  Percent75 - Specifies a 75 percent hatch. The ratio of foreground color to background color is 75:100.  Percent80 - Specifies a 80 percent hatch. The ratio of foreground color to background color is 80:100.  Percent90 - Specifies a 90 percent hatch. The ratio of foreground color to background color is 90:100.
0x0004	<p>The fill pattern is light gray. Additional properties in the corresponding GelFrame record (section 2.4.131) specify which of the following light gray patterns is used.</p>  Percent25 - Specifies a 25 percent hatch. The ratio of foreground color to background color is 25:100.
0x0005	<p>The fill pattern is horizontal stripes. Additional properties in the corresponding GelFrame record (section 2.4.131) specify which of the following horizontal stripe pattern is used.</p>  DarkHorizontal - Specifies a pattern of horizontal lines.
0x0006	<p>The fill pattern is vertical stripes. Additional properties in the corresponding GelFrame record (section 2.4.131) specify which of the following vertical stripes patterns is used.</p>  DarkVertical - Specifies a pattern of vertical lines.
0x0007	<p>The fill pattern is downward diagonal stripes. Additional properties in the corresponding GelFrame record (section 2.4.131) specify which of the following diagonal stripes patterns is used.</p>  DarkDownwardDiagonal - Specifies diagonal lines that slant to the right from top points to bottom points. This hatch pattern is not anti-aliased.  WideDownwardDiagonal - Specifies diagonal lines that slant to the right from top points to bottom points, are 1.5 times the width of DarkDownwardDiagonal, but are not anti-aliased.
0x0008	<p>The fill pattern is upward diagonal stripes. Additional properties in the</p>

Value	Meaning
	<p>corresponding GelFrame record (section 2.4.131) specify which of the following diagonal stripes patterns is used.</p> <p> DarkUpwardDiagonal - Specifies diagonal lines that slant to the left from top points to bottom points, but the lines are not anti-aliased.</p> <p> WideUpwardDiagonal - Specifies diagonal lines that slant to the left from top points to bottom points, are 1.5 times the width of DarkUpwardDiagonal, but are not anti-aliased.</p>
0x0009	<p>The fill pattern is grid. Additional properties in the corresponding GelFrame record (section 2.4.131) specify which of the following grid patterns is used.</p> <p> LargeCheckerBoard - Specifies a hatch that has the appearance of a checkerboard with squares that are twice the size of SmallCheckerBoard.</p> <p> Plaid - Specifies a hatch that has the appearance of a plaid material.</p> <p> SmallCheckerBoard - Specifies a hatch that has the appearance of a checkerboard.</p> <p> SolidDiamond - Specifies a hatch that has the appearance of a checkerboard placed diagonally.</p> <p> Sphere - Specifies a hatch that has the appearance of spheres laid adjacent to one another.</p>
0x000A	<p>The fill pattern is trellis. Additional properties in the corresponding GelFrame record (section 2.4.131) specify which of the following trellis patterns is used.</p> <p> Trellis - Specifies a hatch that has the appearance of a trellis.</p>
0x000B	<p>The fill pattern is light horizontal stripes. Additional properties in the corresponding GelFrame record (section 2.4.131) specify which of the following light horizontal stripes patterns is used.</p> <p> DashedHorizontal - Specifies dashed horizontal lines.</p> <p> LightHorizontal - Specifies a pattern of horizontal lines.</p> <p> NarrowHorizontal - Specifies horizontal lines that are spaced 25 percent closer together than LightHorizontal.</p>
0x000C	<p>The fill pattern is light vertical stripes. Additional properties in the corresponding GelFrame record (section 2.4.131) specify which of the following light vertical stripes patterns is used.</p>

Value	Meaning
	 DashedVertical - Specifies dashed vertical lines.  LightVertical - Specifies a pattern of vertical lines.  NarrowVertical - Specifies vertical lines that are spaced 25 percent closer together than LightVertical.
0x000D	<p>The fill pattern is light down. Additional properties in the corresponding GelFrame record (section 2.4.131) specify which of the following light down patterns is used.</p>  DashedDownwardDiagonal – Specifies dashed diagonal lines that slant to the right from top points to bottom points.  DiagonalBrick – Specifies a hatch that has the appearance of layered bricks that slant to the left from top points to bottom points.  DottedGrid – Specifies horizontal and vertical lines (each of which is composed of dots) that cross.  LightDownwardDiagonal - Specifies diagonal lines that slant to the right from top points to bottom points, but are not anti-aliased.  OutlinedDiamond - Specifies forward diagonal and backward diagonal lines that cross but are not anti-aliased.  Shingle - Specifies a hatch that has the appearance of diagonally layered shingles that slant to the right from top points to bottom points.  Wave - Specifies horizontal lines that is composed of tildes.  ZigZag - Specifies horizontal lines that are composed of zigzags.
0x000E	<p>The fill pattern is light up. Additional properties in the corresponding GelFrame record (section 2.4.131) specify which of the following light up patterns is used.</p>  DashedUpwardDiagonal – Specifies dashed diagonal lines that slant to the left from top points to bottom points.  Divot - Specifies a hatch that has the appearance of divots.

Value	Meaning
	 LightUpwardDiagonal - Specifies diagonal lines that slant to the left from top points to bottom points, but they are not anti-aliased.  Weave - Specifies a hatch that has the appearance of a woven material.
0x000F	<p>The fill pattern is light grid. Additional properties in the corresponding GelFrame record (section 2.4.131) specify which of the following light grid patterns is used.</p>  HorizontalBrick - Specifies a hatch that has the appearance of horizontally layered bricks.  LargeGrid - Specifies horizontal and vertical lines that cross.  SmallGrid - Specifies horizontal and vertical lines that cross and are spaced 50 percent closer together than hatch style LargeGrid.
0x0010	<p>The fill pattern is light trellis. Additional properties in the corresponding GelFrame record (section 2.4.131) specify which of the following light trellis patterns is used.</p>  Percent30 - Specifies a 30 percent hatch. The ratio of foreground color to background color is 30:100.  Percent40 - Specifies a 40 percent hatch. The ratio of foreground color to background color is 40:100.  LargeConfetti - Specifies a hatch that has the appearance of confetti, and is composed of larger pieces than SmallConfetti.
0x0011	<p>The fill pattern is grayscale of 0.125 (1/8) value. Additional properties in the corresponding GelFrame record (section 2.4.131) specify which of the following grayscale patterns is used.</p>  Percent20 - Specifies a 20 percent hatch. The ratio of foreground color to background color is 20:100.  DottedDiamond - Specifies forward diagonal and backward diagonal lines (each of which is composed of dots) that cross.  SmallConfetti - Specifies a hatch that has the appearance of confetti.
0x0012	<p>The fill pattern is grayscale of 0.0625 (1/16) value. Additional properties in the corresponding GelFrame record (section 2.4.131) specify which of the following grayscale patterns is used.</p>

Value	Meaning
	 Percent5 - Specifies a 5 percent hatch. The ratio of foreground color to background color is 5:100.
	 Percent10 - Specifies a 10 percent hatch. The ratio of foreground color to background color is 10:100.

A - fAuto (1 bit): A bit that specifies whether the fill colors are automatically set. If **fls** is equal to 0x1 formatting is automatic. The default value of this field is 1.

B - fInvertNeg (1 bit): A bit that specifies whether the foreground and background are swapped when the data value of the filled area is negative. This field MUST be ignored if the formatting is not being applied to a **data points** (section [2.2.3.10](#)) on a bar or column **chart group** (section [2.2.3.7](#)). The default value of this field is 0.

reserved (14 bits): MUST be zero, and MUST be ignored.

icvFore (2 bytes): An **IcvChart structure** (section [2.5.162](#)) that specifies the foreground color of the fill pattern. The default value of this field is automatically selected from the next available color in the **chart** (section 2.2.3.3) color table.

icvBack (2 bytes): An **IcvChart structure** (section 2.5.162) that specifies the background color of the fill pattern. The default value of this field is 0x0009.

2.4.4 Array

The **Array** record specifies an array **formula** (section [2.2.2](#)) for a **range of cells** that performs calculations on one or more sets of values, and then returns either a single result or multiple results across a continuous range of cells. This record is preceded by a single **Formula** record (section [2.4.127](#)) that defines the first cell in the range that uses this array **formula** (section 2.2.2). Other **Formula** records (section 2.4.127) that use this array **formula** (section 2.2.2) follow later in the file, not necessarily in a contiguous sequence. **Formula** records (section 2.4.127) that use this array **formula** (section 2.2.2) MUST have a **cell** field that is within the range specified in the **ref** field of this record and MUST have their **formula** begin with **PtgExp** (section [2.5.198.58](#)). Also, each cell specified in the **ref** field MUST have a **Formula** (section 2.4.127) that uses this array **formula** (section 2.2.2).

0	1	2	3	4	5	6	7	8	9	10	1	2	3	4	5	6	7	8	9	20	1	2	3	4	5	6	7	8	9	30	1	
ref																																
...																A	reserved															
unused																																
formula (variable)																																
...																																

ref (6 bytes): A **Ref structure** (section [2.5.207](#)) that specifies the range of the array **formula** (section 2.2.2).

A - fAlwaysCalc (1 bit): A bit that specifies whether the array **formula** (section 2.2.2) needs to be calculated during the next recalculation.

reserved (15 bits): MUST be zero, and MUST be ignored.

unused (4 bytes): Undefined and MUST be ignored.

formula (variable): An **ArrayParsedFormula structure** (section [2.5.198.1](#)) that specifies the array **formula** (section 2.2.2).

2.4.5 AttachedLabel

The **AttachedLabel** record specifies properties of a **data label** (section [2.2.3.11](#)) on a **chart group** (section [2.2.3.7](#)), **series** (section [2.2.3.9](#)), or **data point** (section [2.2.3.10](#)). Refer to the **data label** (section 2.2.3.11) overview for additional information about how this record is used and when this record is ignored.

0	1	2	3	4	5	6	7	8	9	10	11	12	13	14	15	16	17	18	19	20	1	2	3	4	5	6	7	8	9	30	1
A	B	C	D	E	F	G	reserved																								

A - fShowValue (1 bit): A bit that specifies whether the value, or the vertical value on bubble or scatter **chart groups** (section 2.2.3.7), is displayed in the **data label** (section 2.2.3.11).

This value MUST be 0 if this record is in a **chart group** (section 2.2.3.7) and either **fShowLabelAndPerc** or **fShowPercent** is equal to 1.

B - fShowPercent (1 bit): A bit that specifies whether the value, represented as a percentage of the sum of the values of the **series** (section 2.2.3.9) the **data label** (section 2.2.3.11) is associated with, is displayed in the **data label** (section 2.2.3.11).

MUST equal 0 if the **chart group** (section 2.2.3.7) type of the corresponding **chart group** (section 2.2.3.7), **series** (section 2.2.3.9), or **data point** (section 2.2.3.10), is not bar of pie, doughnut, pie, or pie of pie **chart group** (section 2.2.3.7).

If this record is contained in a **chart group** (section 2.2.3.7) and **fShowLabelAndPerc** is equal to 1 then this field MUST equal 1.

C - fShowLabelAndPerc (1 bit): A bit that specifies whether the **category (2)** name and value, represented as a percentage of the sum of the values of the **series** (section 2.2.3.9) the **data label** (section 2.2.3.11) is associated with, are displayed in the **data label** (section 2.2.3.11).

MUST equal 0 if the **chart group** (section 2.2.3.7) type of the corresponding **chart group** (section 2.2.3.7), **series** (section 2.2.3.9), or **data point** (section 2.2.3.10), is not bar of pie, doughnut, pie, or pie of pie **chart group** (section 2.2.3.7).

D - unused (1 bit): Undefined and MUST be ignored.

E - fShowLabel (1 bit): A bit that specifies whether the category (2), or the horizontal value on bubble or scatter **chart groups** (section 2.2.3.7), is displayed in the **data label** (section 2.2.3.11) on a non-area **chart group** (section 2.2.3.7), or the **series** (section 2.2.3.9) name is displayed in the **data label** (section 2.2.3.11) on an area **chart group** (section 2.2.3.7).

This field MUST equal 0 if this record is contained in a **chart group** (section 2.2.3.7) and one of the following conditions is satisfied:

- The **fShowValue** field is equal to 1.
- The **fShowLabelAndPerc** field is equal to 0 and the **fShowPercent** field is equal to 1.

F - fShowBubbleSizes (1 bit): A bit that specifies whether the **bubble size** is displayed in the **data label** (section 2.2.3.11).

MUST equal 0 if the **chart group** (section 2.2.3.7) type of the corresponding **chart group** (section 2.2.3.7), **series** (section 2.2.3.9), or **data point** (section 2.2.3.10) is not bubble **chart group** (section 2.2.3.7).

If the current record is contained in a **chart group** (section 2.2.3.7) and **fShowPercent**, **fShowValue**, or **fShowLabel** equal 1, this field MUST equal 0.

G - fShowSeriesName (1 bit): A bit that specifies whether the **data label** (section 2.2.3.11) contains the name of the **series** (section 2.2.3.9).

If the current record is contained in a **chart group** (section 2.2.3.7) and **fShowLabelAndPerc**, **fShowPercent**, **fShowValue**, **fShowValue**, **fShowLabel**, or **fShowBubbleSizes** equal 1 then this MUST equal to 0.

reserved (9 bits): MUST be zero, and MUST be ignored.

2.4.6 AutoFilter

The **AutoFilter** record specifies an **AutoFilter**. An **Lbl record** (section 2.4.150) where the **Name** field has a value of 0x0D (**_FilterDatabase**) MUST exist for the current **sheet (1)**. The **rgce.rgce** field of the **Lbl record** (section 2.4.150) MUST consist of a single **PtgArea3d operand** (section 2.5.198.28).)

0	1	2	3	4	5	6	7	8	9	10	11	12	13	14	15	16	17	18	19	20	21	22	23	24	25	26	27	28	29	30	31
iEntry											A	B	C	D	E	F	wTopN														
doper1																															
...																															
...											doper2																				
...																															
...																															
str1 (variable)																															
...																															
str2 (variable)																															
...																															

iEntry (2 bytes): An unsigned integer that specifies the sheet (1) column that this AutoFilter applies to. The column index is determined by the following formula:

((the **area.columnFirst** field of the **PtgArea3d** (section 2.5.198.28) in the **rgce.rgce** field of the **Lbl record** (section 2.4.150) where the **Name** field is equal to 0x0D (_FilterDatabase) and the **Lbl record** (section 2.4.150) is for the current sheet (1)) + **iEntry**).

The value of **iEntry** MUST be less than the **cEntries** field of the preceding **AutoFilterInfo** record (section 2.4.8).

A - wJoin (2 bits): A **Boolean** (section 2.5.14) that specifies whether **doper1** and **doper2** are combined using a logical AND operation or a logical OR operation. MUST be a value from the following table:

Value	Meaning
0	doper1 and doper2 are combined using a logical AND operation.
1	doper1 and doper2 are combined using a logical OR operation.

If **fTopN** is 1, **wJoin** is undefined and MUST be ignored.

B - fSimple1 (1 bit): A bit that specifies whether an application-specific performance optimization can be used to compute this AutoFilter. MUST be 1 if and only if **doper1.vt** is 0x06 and **doper1.vtValue** is not a regular expression string, or **doper1.vt** is 0x0C, or **doper1.vt** is 0x0E. If **fTopN** is 1, **fSimple1** is undefined and MUST be ignored.

C - fSimple2 (1 bit): A bit that specifies whether an application-specific performance optimization can be used to compute this AutoFilter. MUST be 1 if and only if **doper2.vt** is 0x06 and **doper2.vtValue** is not a regular expression string, or **doper2.vt** is 0x0C, or **doper2.vt** is 0x0E. If **fTopN** is 1, **fSimple2** is undefined and MUST be ignored.

D - fTopN (1 bit): A bit that specifies whether the AutoFilter is a **Top N filter**.

E - fTop (1 bit): A bit that specifies whether the Top N filter selects the bottom items or the top items. MUST be a value from the following table:

Value	Meaning
0	Top N filter selects the bottom items.
1	Top N filter selects the top items.

If **fTopN** is 0, **fTop** is undefined and MUST be ignored.

F - fPercent (1 bit): A bit that specifies whether the Top N filter selects a count of items or a percent of items. MUST be a value from the following table:

Value	Meaning
0	Top N filter selects a count of items.
1	Top N filter selects a percent of items.

If **fTopN** is 0, **fPercent** is undefined and MUST be ignored.

wTopN (9 bits): An unsigned integer that specifies the number of Top N filter items to show. If **fTopN** is 0, **wTopN** MUST be ignored. If **fTopN** is 1, **wTopN** MUST be greater than or equal to 1 and less than or equal to 500.

doper1 (10 bytes): An **AFDOper structure** (section 2.5.5) that specifies the first AutoFilter condition. If **fTopN** is 1, **doper1** is undefined and MUST be ignored.

doper2 (10 bytes): An **AFDOper structure** (section 2.5.5) that specifies the second AutoFilter condition. If **fTopN** is 1, **doper2** is undefined and MUST be ignored.

str1 (variable): An optional **XLUnicodeStringNoCch structure** (section 2.5.296) that specifies the string comparison constant for **doper1**. MUST exist if and only if **doper1.vt** is equal to 0x06. The length MUST be equal to **doper1.vtValue.cch**.

str2 (variable): An optional **XLUnicodeStringNoCch structure** (section 2.5.296) that specifies the string comparison constant for **doper2**. MUST exist if and only if **doper2.vt** is equal to 0x06. The length MUST be equal to **doper2.vtValue.cch**.

2.4.7 AutoFilter12

The **AutoFilter12** record specifies **AutoFilter** properties.

0	1	2	3	4	5	6	7	8	9	10	11	12	13	14	15	16	17	18	19	20	21	22	23	24	25	26	27	28	29	30	31				
frtRefHeader																																			
...																																			
...																																			
iEntry																fHideArrow																			
...																ft																			
...																cft																			
...																cCriteria																			
...																cDateGroupings																			
...																A		B		unused1															
unused2																																			
idList																																			
guidSview (16 bytes)																																			
...																																			
...																																			
rgb (variable)																																			
...																																			
rgCriteria (variable)																																			

...
rgDateGroupings (variable)
...

frtRefHeader (12 bytes): An **FrtRefHeader structure** (section [2.5.137](#)). The **frtRefHeader.rt** MUST be 0x087E. **frtRefHeader.grbitFrft.FFrftRef** MUST be 0x1. The **frtRefHeader.ref8** field MUST refer to the **range** of **cells** associated with this record.

iEntry (2 bytes): An unsigned integer that specifies the **sheet (1)** column that this AutoFilter applies to. The column index is determined by the following formula:

$$\text{frtRefHeader.ref8.colFirst} + \text{iEntry}.$$

The value of **iEntry** MUST be less than or equal to 255.

fHideArrow (4 bytes): A **Boolean** (section [2.5.14](#)) that specifies whether the user interface used to display AutoFilter settings is **hidden**.

ft (4 bytes): An unsigned integer that specifies the **filter** type. MUST be one of the values in the table specified in **rgb**.

cft (4 bytes): An unsigned integer that specifies the **custom filter** type. MUST be one of the values in the following table:

Value	Meaning
0x00000000	No custom filter
0x00000001	The custom filter displays items that are above average.
0x00000002	The custom filter displays items that are below average.
0x00000008	The custom filter displays items that are from tomorrow.
0x00000009	The custom filter displays items that are from today.
0x0000000A	The custom filter displays items that are from yesterday.
0x0000000B	The custom filter displays items that are from next week.
0x0000000C	The custom filter displays items that are from this week.
0x0000000D	The custom filter displays items that are from last week
0x0000000E	The custom filter displays items that are from next month.
0x0000000F	The custom filter displays items that are from this month.
0x00000010	The custom filter displays items that are from last month.
0x00000011	The custom filter displays items that are from next quarter.
0x00000012	The custom filter displays items that are from this quarter.
0x00000013	The custom filter displays items that are from last quarter.
0x00000014	The custom filter displays items that are from next year.
0x00000015	The custom filter displays items that are from this year.
0x00000016	The custom filter displays items that are from last year.
0x00000017	The custom filter displays items that are from year-to-date.
0x00000018	The custom filter displays items that are from the 1 st quarter.
0x00000019	The custom filter displays items that are from the 2 nd quarter.
0x0000001A	The custom filter displays items that are from the 3 rd quarter.
0x0000001B	The custom filter displays items that are from the 4 th quarter.
0x0000001C	The custom filter displays items that are from the 1 st month.
0x0000001D	The custom filter displays items that are from the 2 nd month.

Value	Meaning
0x0000001E	The custom filter displays items that are from the 3 rd month.
0x0000001F	The custom filter displays items that are from the 4 th month.
0x00000020	The custom filter displays items that are from the 5 th month.
0x00000021	The custom filter displays items that are from the 6 th month.
0x00000022	The custom filter displays items that are from the 7 th month.
0x00000023	The custom filter displays items that are from the 8 th month.
0x00000024	The custom filter displays items that are from the 9 th month.
0x00000025	The custom filter displays items that are from the 10 th month.
0x00000026	The custom filter displays items that are from the 11 th month.
0x00000027	The custom filter displays items that are from the 12 th month.

cCriteria (4 bytes): An unsigned integer that specifies the number of items in **rgCriteria**. MUST be ignored if **ft** is nonzero.

cDateGroupings (4 bytes): An unsigned integer that specifies the number of items in **rgDateGroupings**. MUST be ignored if **ft** is nonzero.

A - reserved1 (3 bits): MUST be zero, and MUST be ignored.

B - fWorksheetAutoFilter (1 bit): A bit that specifies whether this filter is a sheet (1) AutoFilter. A sheet (1) AutoFilter filters items in the sheet specified by the **Worksheet part** (section [2.1.7.20.5](#)) that contains this record. MUST be 1 if and only if **idList** is equal to 0xFFFFFFFF.

unused1 (12 bits): Undefined and MUST be ignored.

unused2 (4 bytes): Undefined and MUST be ignored.

idList (4 bytes): An unsigned integer that specifies the **table** with items that are filtered by this AutoFilter. MUST either be equal to the **idList** field of the associated **TableFeatureType structure** (section [2.5.266](#)) or MUST be 0xFFFFFFFF if this filter is a sheet (1) AutoFilter.

guidSview (16 bytes): A **GUID** as specified by [\[MS-DTYP\]](#) that specifies the associated **UserSViewBegin** record (section [2.4.334](#)). MUST be 0, or MUST be equal to the **guid** field of the preceding **UserSViewBegin** record (section [2.4.334](#)).

rgb (variable): A variable type field whose type and meaning is specified by the value of **ft**, as defined in the following table:

Value of ft	Type of rgb
0x00000000	rgb does not exist. Either cCriteria or cDateGroupings MUST be greater than zero.
0x00000001	rgb is a DXFN12NoCB structure (section 2.5.98) that specifies the cell color to use for the filter.
0x00000002	rgb is a DXFN12NoCB structure (section 2.5.98) that specifies the cell font to use for the filter.
0x00000003	rgb is an AF12CellIcon structure (section 2.5.2) that specifies the cell icon to use for the filter.

rgCriteria (variable): An optional array of **AF12Criteria structures** (section [2.5.3](#)). The length of the array MUST be equal to **cCriteria**. MUST exist if and only if **ft** is zero and **cCriteria** is nonzero. Each element of the array MUST be specified in a separate **ContinueFrnt12** record (section [2.4.62](#)).

rgDateGroupings (variable): An optional array of **AF12DateInfo** structures (section 2.5.4). The length of the array MUST be equal to **cDateGroupings**. MUST exist if and only if **ft** is zero and **cDateGroupings** is nonzero. Each element of the array MUST be specified in a separate **ContinueFrt12** record (section 2.4.62).

2.4.8 AutoFilterInfo

The **AutoFilterInfo** record specifies the number of columns that have **AutoFilter** enabled and specifies the beginning of a collection of records as defined by the **Macro Sheet Substream ABNF** and **Worksheet Substream** ABNF. The collection of records specifies AutoFilter information and data used for sorting a **range**.

0	1	2	3	4	5	6	7	8	9	10	11	12	13	14	15	16	17	18	19	20	21	22	23	24	25	26	27	28	29	30	31
cEntries																															

cEntries (2 bytes): An unsigned integer that specifies the number of columns that have AutoFilter enabled. MUST be greater than or equal to 1 and less than or equal to 256.

2.4.9 AxcExt

The **AxcExt** record specifies additional extension properties of a date **axis** (section 2.2.3.6), along with a **CatSerRange** record (section 2.4.39).

0	1	2	3	4	5	6	7	8	9	10	11	12	13	14	15	16	17	18	19	20	21	22	23	24	25	26	27	28	29	30	31				
catMin																catMax																			
catMajor																duMajor																			
catMinor																duMinor																			
duBase																catCrossDate																			
A	B	C	D	E	F	G	H	reserved																											

catMin (2 bytes): An unsigned integer that specifies the minimum date, as a date in the **date system** specified by the **Date1904** record (section 2.4.77), in the units defined by **duBase**. SHOULD <25> be less than or equal to **catMax**. If **fAutoMin** is set to 1, MUST be ignored. If **fDateAxis** is set to 0, MUST be ignored.

catMax (2 bytes): An unsigned integer that specifies the maximum date, as a date in the date system specified by the **Date1904** record (section 2.4.77), in the units defined by **duBase**. SHOULD <26> be greater than or equal to **catMin**. If **fAutoMax** is set to 1, MUST be ignored. If **fDateAxis** is set to 0, MUST be ignored.

catMajor (2 bytes): An unsigned integer that specifies the interval at which the **major tick marks** are displayed on the **axis** (section 2.2.3.6), in the unit defined by **duMajor**. MUST be greater than or equal to **catMinor** when **duMajor** is equal to **duMinor**. If **fAutoMajor** is set to 1, MUST be ignored. If **fDateAxis** is set to 0, MUST be ignored.

duMajor (2 bytes): A **DateUnit enumeration** (section [2.5.66](#)) that specifies the unit of time to use for **catMajor** when the **axis** (section 2.2.3.6) is a date **axis** (section 2.2.3.6). If **fDateAxis** is set to 0, MUST be ignored.

catMinor (2 bytes): An unsigned integer that specifies the interval at which the **minor tick marks** are displayed on the **axis** (section 2.2.3.6), in a unit defined by **duMinor**. MUST be less than or equal to **catMajor** when **duMajor** is equal to **duMinor**. If **fAutoMinor** is set to 1, MUST be ignored. If **fDateAxis** is set to 0, MUST be ignored.

duMinor (2 bytes): A **DateUnit enumeration** (section 2.5.66) that specifies the unit of time to use for **catMinor** when the **axis** (section 2.2.3.6) is a date **axis** (section 2.2.3.6). If **fDateAxis** is set to 0, MUST be ignored.

duBase (2 bytes): A **DateUnit enumeration** (section 2.5.66) that specifies the smallest unit of time used by the **axis** (section 2.2.3.6). If **fAutoBase** is set to 1, this field MUST be ignored. If **fDateAxis** is set to 0, MUST be ignored.

catCrossDate (2 bytes): An unsigned integer that specifies at which date, as a date in the date system specified by the **Date1904 record** (section 2.4.77), in the units defined by **duBase**, the value **axis** (section 2.2.3.6) crosses this **axis** (section 2.2.3.6). If **fDateAxis** is set to 0, MUST be ignored. If **fAutoCross** is set to 1, MUST be ignored.

A - fAutoMin (1 bit): A bit that specifies whether **catMin** is calculated automatically. If **fDateAxis** is set to 0, MUST be ignored. MUST be a value from the following table:

Value	Meaning
0	The value specified by catMin is used and catMin is not calculated automatically.
1	catMin is calculated such that the minimum data points (section 2.2.3.10) value can be displayed.

B - fAutoMax (1 bit): A bit that specifies whether **catMax** is calculated automatically. If **fDateAxis** is set to 0, then **fAutoMax** MUST be ignored. If the value of the **fMaxCross** field in the **CatSerRange** (section 2.4.39) record is 1, then **fAutoMax** MUST be ignored. MUST be a value from the following table:

Value	Meaning
0	The value specified by catMax is used and catMax is not calculated automatically.
1	catMax is calculated such that the minimum data points (section 2.2.3.10) value can be displayed.

C - fAutoMajor (1 bit): A bit that specifies whether **catMajor** is calculated automatically. If **fDateAxis** is set to 0, MUST be ignored.

Value	Meaning
0	The value specified by catMajor is used and catMajor is not calculated automatically.
1	catMajor is calculated automatically.

D - fAutoMinor (1 bit): A bit that specifies whether **catMinor** is calculated automatically. If **fDateAxis** is set to 0, **MUST** be ignored.

Value	Meaning
0	The value specified by catMinor is used and catMinor is not calculated automatically.
1	catMinor is calculated automatically.

E - fDateAxis (1 bit): A bit that specifies whether the **axis** (section 2.2.3.6) is a date **axis** (section 2.2.3.6). **MUST** be a value from the following table:

Value	Meaning
0	The axis (section 2.2.3.6) is not a date axis (section 2.2.3.6).
1	The axis (section 2.2.3.6) is a date axis (section 2.2.3.6).

F - fAutoBase (1 bit): A bit that specifies whether the units of the date **axis** (section 2.2.3.6) are chosen automatically. If **fDateAxis** is set to 0, **MUST** be ignored. **MUST** be a value from the following table:

Value	Meaning
0	The value specified by duBase is used and duBase is not computed automatically.
1	duBase is calculated automatically.

G - fAutoCross (1 bit): A bit that specifies whether **catCrossDate** is calculated automatically. **MUST** be a value from the following table:

Value	Meaning
0	The value specified by catCrossDate is used and catCrossDate is not calculated automatically.
1	catCrossDate is calculated automatically such that it can be displayed.

H - fAutoDate (1 bit): A bit that specifies whether the **axis** (section 2.2.3.6) type is detected automatically. **MUST** be a value from the following table:

Value	Meaning
0	The axis (section 2.2.3.6) will stay as specified by the fDateAxis field.
1	The axis (section 2.2.3.6) will automatically become a date axis (section 2.2.3.6) when the data it is related to contains date values. Otherwise, the axis (section 2.2.3.6) will be a category (2) axis (section 2.2.3.6).

reserved (8 bits): MUST be zero, and MUST be ignored.

2.4.10 AxesUsed

The **AxesUsed** record specifies the number of **axis groups** (section [2.2.3.5](#)) on the **chart** (section [2.2.3.3](#)).

0	1	2	3	4	5	6	7	8	9	10	11	12	13	14	15	16	17	18	19	20	21	22	23	24	25	26	27	28	29	30	31
cAxes																															

cAxes (2 bytes): An unsigned integer that specifies the number of **axis groups** (section 2.2.3.5) on the **chart** (section 2.2.3.3). MUST be a value from the following table:

Value	Axis present
0x0001	A single primary axis group (section 2.2.3.5) is present.
0x0002	Both a primary axis group (section 2.2.3.5) and a secondary axis group (section 2.2.3.5) are present.

If no **chart groups** (section [2.2.3.7](#)) are present on the **chart** (section 2.2.3.3), MUST be 0x0001. If the **chart sheet substream** (section [2.1.7.20.1](#)) contains a **Chart3d record** (section [2.4.46](#)), MUST be 0x0001.

2.4.11 Axis

The **Axis** record specifies properties of an **axis** (section [2.2.3.6](#)) and specifies the beginning of a collection of records as defined by the **Chart Sheet Substream ABNF** that specifies an **axis** (section 2.2.3.6).

0	1	2	3	4	5	6	7	8	9	10	11	12	13	14	15	16	17	18	19	20	21	22	23	24	25	26	27	28	29	30	31
wType																reserved1															
...																reserved2															
...																reserved3															
...																reserved4															
...																															

wType (2 bytes): An unsigned integer that specifies the type of **axis** (section 2.2.3.6). The value MUST be 0x0000 if the record is the first **axis** (section 2.2.3.6) in the **axis group** (section [2.2.3.5](#)). The value MUST be 0x0001 if the record is the second **axis** (section 2.2.3.6) in the **axis group** (section 2.2.3.5). The value MUST be 0x0002 if the record is the third **axis** (section 2.2.3.6) in the **axis group** (section 2.2.3.5). MUST be a value from the following table:

Value	Axis type
0x0000	Axis (section 2.2.3.6) type is a horizontal value axis (section 2.2.3.6)

Value	Axis type
	for a scatter chart group (section 2.2.3.7) or a bubble chart group (section 2.2.3.7), or category (2) axis (section 2.2.3.6) for all other chart group (section 2.2.3.7) types.
0x0001	Axis (section 2.2.3.6) type is a vertical value axis (section 2.2.3.6) for a scatter chart group (section 2.2.3.7) or a bubble chart group (section 2.2.3.7), or value axis (section 2.2.3.6) for all other chart group (section 2.2.3.7) types.
0x0002	Axis (section 2.2.3.6) type is a series axis (section 2.2.3.6).

reserved1 (4 bytes): MUST be zero, and MUST be ignored.

reserved2 (4 bytes): MUST be zero, and MUST be ignored.

reserved3 (4 bytes): MUST be zero, and MUST be ignored.

reserved4 (4 bytes): MUST be zero, and MUST be ignored.

2.4.12 AxisLine

The **AxisLine** record specifies which part of the **axis** (section [2.2.3.6](#)) is specified by the **LineFormat** record (section [2.4.156](#)) that follows.

0	1	2	3	4	5	6	7	8	9	10	11	12	13	14	15	16	17	18	19	20	21	22	23	24	25	26	27	28	29	30	31
id																															

id (2 bytes): An unsigned integer that specifies which part of the **axis** (section 2.2.3.6) is defined by the **LineFormat** record (section 2.4.156) that follows be unique among all other **id** field values in **AxisLine** records in the current **axis** (section 2.2.3.6). MUST be greater than the **id** field values in preceding **AxisLine** records in the current **axis** (section 2.2.3.6). MUST be a value from the following table:

Value	Part of the axis defined
0x0000	The axis (section 2.2.3.6) line itself.
0x0001	The major gridlines along the axis (section 2.2.3.6).
0x0002	The minor gridlines along the axis (section 2.2.3.6).
0x0003	The walls or floor of a 3-D chart (section 2.2.3.3).

In the case where **id** is set to 0x0003, this record MUST be preceded by an **Axis** record (section [2.4.11](#)) with the **wType** set to a value from the following table:

Value of wType	Formatted object
0x0000	The walls of a 3-D chart (section 2.2.3.3).
0x0001	The floor of a 3-D chart (section 2.2.3.3).

2.4.13 AxisParent

The **AxisParent** record specifies properties of an **axis group** (section 2.2.3.5) and specifies the beginning of a collection of records as defined by the **Chart Sheet Substream ABNF** that specifies an **axis group** (section 2.2.3.5).

0	1	2	3	4	5	6	7	8	9	10	1	2	3	4	5	6	7	8	9	20	1	2	3	4	5	6	7	8	9	30	1		
iax																unused (16 bytes)																	
...																																	
...																																	
...																																	

iax (2 bytes): A **Boolean** (section 2.5.14) that specifies whether the **axis group** (section 2.2.3.5) is primary or secondary. MUST be a value from the following table. This field MUST equal 0 when in the first **AxisParent record** in the Chart Sheet Substream ABNF. This field MUST equal 1 when in the second **AxisParent record** in the Chart Sheet Substream ABNF.

Value	Meaning
0x0000	Axis group (section 2.2.3.5) is primary.
0x0001	Axis group (section 2.2.3.5) is secondary.

unused (16 bytes): Undefined and MUST be ignored.

2.4.14 Backup

The **Backup** record specifies whether to save a backup copy of the **workbook**.

0	1	2	3	4	5	6	7	8	9	10	1	2	3	4	5	6	7	8	9	20	1	2	3	4	5	6	7	8	9	30	1		
fBackup																																	

fBackup (2 bytes): A **Boolean** (section 2.5.14) that specifies whether to save a backup file. The value 1 means that a backup copy of the workbook is saved when the workbook is saved.

2.4.15 Bar

The **Bar** record specifies that the **chart group** (section 2.2.3.7) is a **bar chart group** (section 2.2.3.7) or a **column chart group** (section 2.2.3.7), and specifies the **chart group** (section 2.2.3.7) attributes.

0	1	2	3	4	5	6	7	8	9	10	1	2	3	4	5	6	7	8	9	20	1	2	3	4	5	6	7	8	9	30	1		
pcOverlap																pcGap																	
A	B	C	D	reserved																													

pcOverlap (2 bytes): A signed integer that specifies the overlap between **data points** (section 2.2.3.10) in the same **category (2)** as a percentage of the **data points** (section 2.2.3.10) width. MUST be greater than or equal to -100 and less than or equal to 100. MUST be a value from the following table:

Value	Meaning
-100 to -1	Size of the separation between data points (section 2.2.3.10).
0	No overlap.
1 to 100	Size of the overlap between data points (section 2.2.3.10).

pcGap (2 bytes): An unsigned integer that specifies the width of the gap between the categories (2) and the left and right edges of the **plot area** as a percentage of the **data point** (section 2.2.3.10) width divided by 2. It also specifies the width of the gap between adjacent categories (2) as a percentage of the **data point** (section 2.2.3.10) width. MUST be less than or equal to 500.

A - fTranspose (1 bit): A bit that specifies whether the **data points** (section 2.2.3.10) and value **axis** (section 2.2.3.6) are horizontal (for a bar **chart group** (section 2.2.3.7)) or vertical (for a column **chart group** (section 2.2.3.7)). MUST be a value from the following table:

Value	Meaning
0	Data points (section 2.2.3.10) and value axis (section 2.2.3.6) are vertical.
1	Data points (section 2.2.3.10) and value axis (section 2.2.3.6) are horizontal.

B - fStacked (1 bit): A bit that specifies whether the **data points** (section 2.2.3.10) in the **chart group** (section 2.2.3.7) that share the same category (2) are stacked.

C - f100 (1 bit): A bit that specifies whether the **data points** (section 2.2.3.10) in the **chart group** (section 2.2.3.7) are displayed as a percentage of the sum of all **data points** (section 2.2.3.10) in the **chart group** (section 2.2.3.7) that share the same category (2). MUST be 0 if **fStacked** is 0.

D - fHasShadow (1 bit): A bit that specifies whether one or more **data points** (section 2.2.3.10) in the **chart group** (section 2.2.3.7) has shadows.

reserved (12 bits): MUST be zero, and MUST be ignored.

2.4.16 BCUsrs

The **BCUsrs** record specifies the beginning of a collection of **UsrInfo records** (section 2.4.340) as defined in the **user names** stream **ABNF**. The collection of **UsrInfo records** (section 2.4.340) specifies information about a user who currently has the **shared workbook** (section 2.2.11) open.

0	1	2	3	4	5	6	7	8	9	10	11	12	13	14	15	16	17	18	19	20	21	22	23	24	25	26	27	28	29	30	31
iCount																															

iCount (2 bytes): An unsigned integer that specifies the number of users of an operating system **Briefcase** who have the current **workbook** open.

2.4.17 Begin

The **Begin** record specifies the beginning of a collection of records as defined by the **Chart Sheet Substream** **ABNF**. The collection of records specifies properties of a **chart**.

2.4.18 BigName

The **BigName** record specifies a name/value pair of arbitrary user-defined data that is associated with the current **sheet (1)**.

0	1	2	3	4	5	6	7	8	9	10	11	12	13	14	15	16	17	18	19	20	21	22	23	24	25	26	27	28	29	30	31
reserved											lcbData																				
...											cbName					rgbName (variable)															
...																															
rgbData (variable)																															
...																															

reserved (2 bytes): MUST be 0x1000, and MUST be ignored.

lcbData (4 bytes): A signed integer that specifies the byte count for **rgbData**. MUST be greater than or equal to zero.

cbName (1 byte): An unsigned integer that specifies the byte count for **rgbName**.

rgbName (variable): An array of ANSI characters whose length is specified by **cbName** that specifies the name of the custom property.

rgbData (variable): An array of bytes that specifies the value of the custom property. It can continue with the [ContinueBigName](#) records.

2.4.19 BkHim

The **BkHim** record specifies image data for a **sheet (1)** background.

0	1	2	3	4	5	6	7	8	9	10	11	12	13	14	15	16	17	18	19	20	21	22	23	24	25	26	27	28	29	30	31
cf											reserved																				
lcb																															
imageBlob (variable)																															
...																															

cf (2 bytes): A signed integer that specifies the image format. MUST be a value from the following table:

Value	Meaning
0x0009	Bitmap format. The image data is stored in a bitmap format as described in [MSDN-BMP] .

Value	Meaning
0x000E	Native format. The image data is stored in the native format of another application and cannot be directly processed.

reserved (2 bytes): MUST be 0x0001, and MUST be ignored.

lcb (4 bytes): A signed integer that specifies the size of **imageBlob** in bytes. MUST be greater than or equal to 1.

imageBlob (variable): An array of bytes that specifies the image data for the given format.

2.4.20 Blank

The **Blank** record specifies an empty **cell** with no formula (section [2.2.2](#)) or value.

0	1	2	3	4	5	6	7	8	9	10	11	12	13	14	15	16	17	18	19	20	21	22	23	24	25	26	27	28	29	30	31
cell																															
...																															

cell (6 bytes): A [Cell](#) structure that specifies the cell.

2.4.21 BOF

The **BOF** record specifies the beginning of the individual substreams as specified by the [workbook](#) section. It also specifies history information for the substreams.

0	1	2	3	4	5	6	7	8	9	10	11	12	13	14	15	16	17	18	19	20	21	22	23	24	25	26	27	28	29	30	31
vers																dt															
rupBuild																rupYear															
A	B	C	D	E	F	G	H	I	J	K	L	M				N	reserved1														
verLowestBiff						O				reserved2																					

vers (2 bytes): An unsigned integer that specifies the **BIFF** version of the file. The value MUST be 0x0600.

dt (2 bytes): An unsigned integer that specifies the document type of the substream of records following this record. For more information about the layout of the sub-streams in the workbook stream see [File Structure](#). MUST be a value from the following table:

Value	Meaning
0x0005	Specifies the workbook substream.
0x0010	Specifies the dialog sheet substream or the worksheet substream.

Value	Meaning
	The sheet (1) substream that starts with this BOF record MUST contain one WsBool record. If the fDialog field in that WsBool is 1 then the sheet (1) is dialog sheet otherwise the sheet (1) is a worksheet .
0x0020	Specifies the chart sheet substream.
0x0040	Specifies the macro sheet substream.

rupBuild (2 bytes): An unsigned integer that specifies the **build identifier**.

rupYear (2 bytes): An unsigned integer that specifies the year when this BIFF version was first created. The value MUST be 0x07CC<27> or 0x07CD.

A - fWin (1 bit): A bit that specifies whether this file was last edited on a Windows platform. The value MUST be 1.

B - fRisc (1 bit): A bit that specifies whether the file was last edited on a Reduced Instruction Set Computing (RISC) platform. The value MUST be 0.

C - fBeta (1 bit): A bit that specifies whether this file was last edited by a **beta** version of the application. The value MUST be 0.

D - fWinAny (1 bit): A bit that specifies whether this file has ever been edited on a Windows platform. The value SHOULD<28> be 1.

E - fMacAny (1 bit): A bit that specifies whether this file has ever been edited on a Macintosh platform. The value MUST be 0.

F - fBetaAny (1 bit): A bit that specifies whether this file has ever been edited by a beta version of the application. The value MUST be 0.

G - unused1 (2 bits): Undefined and MUST be ignored.

H - fRiscAny (1 bit): A bit that specifies whether this file has ever been edited on a RISC platform. The value MUST be 0.

I - fOOM (1 bit): A bit that specifies whether this file had an **out-of-memory** failure.

J - fGIJump (1 bit): A bit that specifies whether this file had an out-of-memory failure during rendering.

K - unused2 (2 bits): Undefined, and MUST be ignored.

L - fFontLimit (1 bit): A bit that specified that whether this file hit the 255 **font** limit<29>.

M - verXLHigh (4 bits): An unsigned integer that specifies the highest version of the application that once saved this file. MUST be a value from the following table:

Value	Meaning
0x0	Specifies the highest version of the application that has ever saved this file. <30>
0x1	Specifies the highest version of the application that has ever saved this file. <31>
0x2	Specifies the highest version of the application that has ever saved this file. <32>
0x3	Specifies the highest version of the application that has ever saved this file. <33>
0x4	Specifies the highest version of the application that has ever saved this file. <34>
0x6	Specifies the highest version of the application that has ever saved this file. <35>
0x7	Specifies the highest version of the application that has ever saved this file. <36>

N - unused3 (1 bit): Undefined, and MUST be ignored.

reserved1 (13 bits): MUST be zero, and MUST be ignored.

verLowestBiff (8 bits): An unsigned integer that specifies the BIFF version saved. The value MUST be 6.

O - verLastXLSaved (4 bits): An unsigned integer that specifies the application that saved this file most recently. The value MUST be the value of field **verXLHigh** or less. MUST be a value from the following table:

Value	Meaning
0x0	Specifies the highest version of the application that has ever saved this file. <37>
0x1	Specifies the highest version of the application that has ever saved this file. <38>
0x2	Specifies the highest version of the application that has ever saved this file. <39>
0x3	Specifies the highest version of the application that has ever saved this file. <40>
0x4	Specifies the highest version of the application that has ever saved this file. <41>
0x6	Specifies the highest version of the application that has ever saved this file. <42>
0x7	Specifies the highest version of the application that has ever saved this file. <43>

reserved2 (20 bits): MUST be zero, and MUST be ignored.

2.4.22 BookBool

The **BookBool** record specifies some of the properties associated with a **workbook**.

0	1	2	3	4	5	6	7	8	9	10	1	2	3	4	5	6	7	8	9	20	1	2	3	4	5	6	7	8	9	30	1				
A	B	C	D	E	F	G	H	reserved2																											

A - fNoSaveSup (1 bit): A bit that specifies that **external link** values are saved in the workbook. MUST be a value from the following table:

Value	Meaning
0	External link values are saved.
1	External link values are not saved.

B - reserved1 (1 bit): MUST be zero, and MUST be ignored.

C - fHasEnvelope (1 bit): A bit that specifies whether the workbook has an envelope as a result of sending the workbook to a mail recipient. If **fEnvelopeVisible** is 1 or **fEnvelopeInitDone** is 1, then this bit MUST be 1.

D - fEnvelopeVisible (1 bit): A bit that specifies whether the envelope is **visible**.

E - fEnvelopeInitDone (1 bit): A bit that specifies whether the envelope has been initialized.

F - grUpdateLinks (2 bits): An unsigned integer that specifies when the application updates external links in the workbook. The value **MUST** be one of the following:

Value	Meaning
0	Prompt user to update.
1	Do not update, and do not prompt user.
2	Silently update external links. The application can choose to prompt the user because of security concerns<44>.

G - unused (1 bit): Undefined and **MUST** be ignored.

H - fHideBorderUnsellLists (1 bit): A bit that specifies whether to hide borders of **tables** that do not contain the **active cell**<45>.

reserved2 (7 bits): **MUST** be zero, and **MUST** be ignored.

2.4.23 BookExt

The **BookExt** record specifies properties of a **workbook** file.

0	1	2	3	4	5	6	7	8	9	10	11	12	13	14	15	16	17	18	19	20	21	22	23	24	25	26	27	28	29	30	31
frtHeader																															
...																															
...																															
cb																															
A	B	C	D	E	F	G	H	I	reserved																						
grbit1 (optional)								grbit2 (optional)																							

frtHeader (12 bytes): An [FrtHeader](#) structure. The **frtHeader.rt** field **MUST** be 0x0863.

cb (4 bytes): An unsigned integer that specifies the size of the record in bytes.

A - fDontAutoRecover (1 bit): A bit that specifies whether **AutoRecover** is disabled for the workbook.

B - fHidePivotList (1 bit): A bit that specifies whether the PivotTable field list is **hidden** for this workbook.

C - fFilterPrivacy (1 bit): A bit that specifies whether personal information is removed from this workbook on save.

D - fEmbedFactoids (1 bit): A bit that specifies whether **smart tags** are embedded in this workbook on save.

E - mdFactoidDisplay (2 bits): A bit that specifies how smart tags are displayed in the workbook. The value MUST be one of the following:

Value	Meaning
0x00	The application will display the smart tag actions button and the smart tag indicator .
0x01	The application will display the smart tag actions button only. The smart tag indicators will not be displayed.
0x02	The application will not display the smart tag actions button or the smart tag indicator.

F - fSavedDuringRecovery (1 bit): A bit that specifies whether the workbook was saved during AutoRecover.

G - fCreatedViaMinimalSave (1 bit): A bit that specifies whether the workbook was created by a **minimal save** during **data recovery**.

H - fOpenedViaDataRecovery (1 bit): A bit that specifies whether the workbook was opened by means of data recovery.

I - fOpenedViaSafeLoad (1 bit): A bit that specifies whether the workbook was opened in **safe load** mode.

reserved (22 bits): MUST be zero, and MUST be ignored.

grbit1 (1 byte): A [BookExt_Conditional11](#) structure that specifies additional workbook-specific information. This structure MUST exist when **cb** is greater than 20.

grbit2 (1 byte): A [BookExt_Conditional12](#) structure that specifies additional workbook-specific information. This structure MUST exist when **cb** is greater than 21.

2.4.24 BoolErr

The **BoolErr** record specifies a **cell** that contains either a Boolean value or an error value.

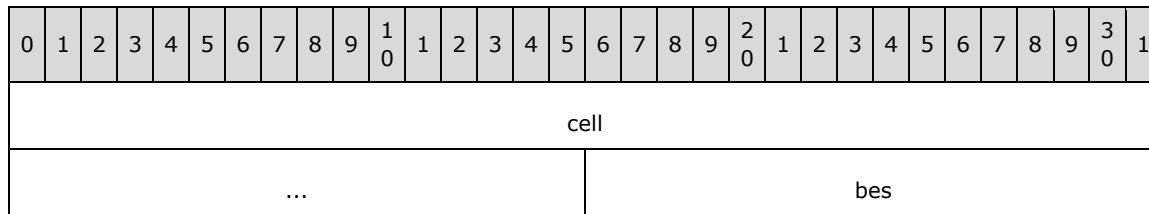

cell (6 bytes): A [Cell](#) structure that specifies the cell.

bes (2 bytes): A [Bes](#) structure that specifies a Boolean or an error value.

2.4.25 BopPop

The **BopPop** record specifies that the [chart group](#) is a bar of pie chart group or a pie of pie chart group and specifies the chart group attributes.

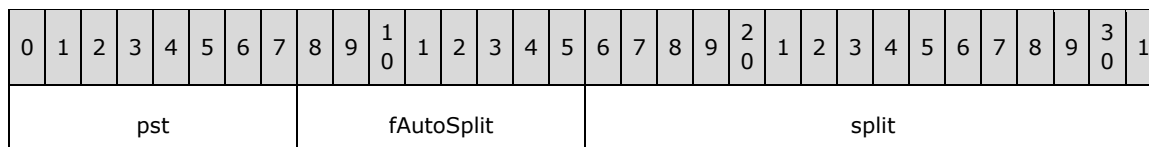

iSplitPos		pcSplitPercent	
pcPie2Size		pcGap	
numSplitValue			
...			
A	reserved		

pst (1 byte): An unsigned integer that specifies whether this chart group is a bar of pie chart group or a pie of pie chart group. MUST be a value from the following table:

Value	Subtype
0x01	Pie of pie chart group
0x02	Bar of pie chart group

fAutoSplit (1 byte): A Boolean (section [2.5.14](#)) that specifies whether the split point of the chart group is determined automatically. If the value is 1, when a bar of pie chart group or pie of pie chart group is initially created the [data points](#) from the **primary pie** are selected and inserted into the **secondary bar/pie** automatically.

split (2 bytes): An unsigned integer that specifies what determines the split between the primary pie and the secondary bar/pie. MUST be ignored if **fAutoSplit** is set to 1. MUST be a value from the following table:

Value	Type of split	Meaning
0x0000	Position	The data is split based on the position of the data point in the series as specified by iSplitPos .
0x0001	Value	The data is split based on a threshold value as specified by numSplitValue .
0x0002	Percent	The data is split based on a percentage threshold and the data point values represented as a percentage as specified by pcSplitPercent .
0x0003	Custom	The data is split as arranged by the user. Custom split is specified in a following BopPopCustom record.

iSplitPos (2 bytes): A signed integer that specifies how many data points are contained in the secondary bar/pie. Data points are contained in the secondary bar/pie starting from the end of the series. For example, if the value is 2, the last 2 data points in the series are contained in the secondary bar/pie. MUST be a value greater than or equal to 0 and less than or equal to 32000. If the value is more than the number of data points in the series, the entire series will be in the secondary bar/pie, except for the first data point. If **split** is not set to 0x0000 or **fAutoSplit** is set to 1, this value MUST be ignored.

pcSplitPercent (2 bytes): A signed integer that specifies the percentage below which each data point is contained in the secondary bar/pie as opposed to the primary pie. The percentage value of a data point is calculated using the following formula:

$$(\text{value of the data point} \times 100) / \text{sum of all data points in the series}$$

If **split** is not set to 0x0002 or if **fAutoSplit** is set to 1, this value MUST be ignored

pcPie2Size (2 bytes): A signed integer that specifies the size of the secondary bar/pie as a percentage of the size of the primary pie. MUST be a value greater than or equal to 5 and less than or equal to 200.

pcGap (2 bytes): A signed integer that specifies the distance between the primary pie and the secondary bar/pie. The distance is specified as a percentage of the average width of the primary pie and secondary bar/pie. MUST be a value greater than or equal to 0 and less than or equal to 500, where 0 is 0% of the average width of the primary pie and the secondary bar/pie, and 500 is 250% of the average width of the primary pie and the secondary bar/pie.

numSplitValue (8 bytes): An Xnum (section [2.5.342](#)) value that specifies the split when the **split** field is set to 0x0001. The value of this field specifies the threshold that selects which data points of the primary pie move to the secondary bar/pie. The secondary bar/pie contains any data points with a value less than the value of this field. If **split** is not set to 0x0001 or if **fAutoSplit** is set to 1, this value MUST be ignored.

A - fHasShadow (1 bit): A bit that specifies whether one or more data points in the chart group have shadows.

reserved (15 bits): MUST be zero, and MUST be ignored.

2.4.26 BopPopCustom

The **BopPopCustom** record specifies which [data points](#) in the [series](#) are contained in the **secondary bar/pie** instead of the **primary pie**. MUST follow a [BopPop](#) record that has its **split** field set to Custom (0x0003).

0	1	2	3	4	5	6	7	8	9	10	11	12	13	14	15	16	17	18	19	20	21	22	23	24	25	26	27	28	29	30	31
cxi																rggrbit (variable)															
...																															

cxi (2 bytes): An unsigned integer that specifies to the number of data points in the series plus one. MUST be less than 32000.

rggrbit (variable): A sequence of bits that specifies whether each data point in the series is contained in the primary pie or the secondary bar/pie. For each data point a corresponding bit specifies whether a data point is contained in the secondary bar/pie or primary pie as specified in the following table:

Value	Meaning
0	Data point is contained in the primary pie.
1	Data point is contained in the secondary bar/pie.

The size of this field, in bytes, is calculated using the following formula:

$$\text{size of rggrbit in bytes} = 1 + \text{floor}(\text{cxi} / 8)$$

The padding of this field, in bits, is calculated using the following formula:

$$\text{padding} = \text{size of rggrbit in bits} - \text{cxi}$$

The position of each bit in the sequence corresponds to the position of each data point in the series arranged as follows:

- Any padding is placed in the most significant bits of the first byte. The next most significant bit of the first byte corresponds to the first data point in the series. If there are any more unused bits in the first byte, the next most significant bit corresponds to the second data point in the series. This pattern continues until there are no remaining unused bits in the first byte.
- The most significant bit of the next byte corresponds to the next data point in the series. The next most significant bit contains the next data point in the series. This pattern continues for each byte in the sequence.
- The least significant bit of the final byte is an additional bit that specifies whether the secondary bar/pie does not contain data points. If the value of the additional bit is 1, the value of every other bit MUST be 0.

The following figure demonstrates this order:

Byte 0							
0 (LSB)	1	2	3	4	5	6	7
Data Point 3	Data Point 2	Data Point 1	Data Point 0	Padding			

Byte 1							
8	9	10	11	12	13	14	15 (MSB)
Additional Bit	Data Point 10	Data Point 9	Data Point 8	Data Point 7	Data Point 6	Data Point 5	Data Point 4

2.4.27 BottomMargin

The **BottomMargin** record specifies the bottom margin of the current **sheet (1)**.

0	1	2	3	4	5	6	7	8	9	10	11	12	13	14	15	16	17	18	19	20	21	22	23	24	25	26	27	28	29	30	31
num																															
...																															

num (8 bytes): An Xnum (section [2.5.342](#)) value that specifies the bottom margin of the current sheet (1) in inches. The value MUST be greater than or equal to 0 and less than or equal to 49.

2.4.28 BoundSheet8

The **BoundSheet8** record specifies basic information about a **sheet (1)**, including the sheet (1) name, **hidden** state, and type of sheet (1).

0	1	2	3	4	5	6	7	8	9	10	11	12	13	14	15	16	17	18	19	20	21	22	23	24	25	26	27	28	29	30	31
lbPlyPos																															
A	unused					dt					stName (variable)																				
...																															

lbPlyPos (4 bytes): A FilePointer as specified in [\[MS-OSHARED\]](#) section 2.2.1.5 that specifies the stream position of the start of the [BOF](#) record for the sheet (1).

A - hsState (2 bits): An unsigned integer that specifies the hidden state of the sheet (1). MUST be a value from the following table:

Value	Meaning
0x00	Visible
0x01	Hidden
0x02	Very Hidden; the sheet (1) is hidden and cannot be displayed using the user interface.

unused (6 bits): Undefined and MUST be ignored.

dt (8 bits): An unsigned integer that specifies the sheet (1) type. MUST be a value from the following table:

Value	Meaning
0x00	Worksheet or dialog sheet The sheet substream that starts with the BOF record specified in lbPlyPos MUST contain one WsBool record. If the fDialog field in that WsBool is 1 then the sheet is dialog sheet. Otherwise, the sheet is a worksheet.
0x01	Macro sheet
0x02	Chart sheet
0x06	VBA module

stName (variable): A [ShortXLUnicodeString](#) structure that specifies the unique case-insensitive name of the sheet (1). The character count of this string, **stName.cch**, MUST be greater than or equal to 1 and less than or equal to 31. The string MUST NOT contain the any of the following characters:

- 0x0000
- 0x0003

- colon (:)
- backslash (\)
- asterisk (*)
- question mark (?)
- forward slash (/)
- opening square bracket ([)
- closing square bracket (])

The string MUST NOT begin or end with the single quote (') character.

2.4.29 BRAI

The **BRAI** record specifies a reference to data in a sheet that is used by a part of a [series](#), [legend entry](#), [trendline](#) or [error bars](#).

0	1	2	3	4	5	6	7	8	9	10	11	12	13	14	15	16	17	18	19	20	21	22	23	24	25	26	27	28	29	30	31
id										rt						A	reserved														
ifmt																formula (variable)															
...																															

id (1 byte): An unsigned integer that specifies the part of the series, trendline, or error bars the referenced data specifies. MUST be a value from the following table:

Value	Meaning
0x00	Referenced data specifies the series, legend entry, or trendline name. Error bars name MUST be empty.
0x01	Referenced data specifies the values or horizontal values on bubble and scatter chart groups of the series and error bars.
0x02	Referenced data specifies the categories (2) or vertical values on bubble and scatter chart groups of the series and error bars.
0x03	Referenced data specifies the bubble size values of the series.

rt (1 byte): An unsigned integer that specifies the type of data that is being referenced. MUST be a value from the following table:

Value	Meaning
0x00	The data source is a category (2) name, series name or bubble size that was automatically generated.
0x01	The data source is the text or value as specified by the formula field.
0x02	The data source is the value from a range of cells in a sheet specified by the formula field.

A - fUnlinkedIfmt (1 bit): A bit that specifies whether the part of the [chart](#) specified by the **id** field uses number formatting from the referenced data. MUST be a value from the following table:

Value	Meaning
0x0	The data uses the number formatting of the referenced data.
0x1	The data uses the custom number formatting specified in the ifmt field.

reserved (15 bits): MUST be zero, and MUST be ignored.

ifmt (2 bytes): An [IFmt](#) structure that specifies the **number format** to use for the data.

formula (variable): A [ChartParsedFormula](#) structure that specifies the formula (section [2.2.2](#)) that specifies the reference.

2.4.30 BuiltInFnGroupCount

The **BuiltInFnGroupCount** record specifies the beginning of a collection of records as defined by the [Globals Substream ABNF](#). The collection of records specifies information about the built-in **function categories** in the **workbook**.

0	1	2	3	4	5	6	7	8	9	10	1	2	3	4	5	6	7	8	9	20	1	2	3	4	5	6	7	8	9	30	1
count																															

count (2 bytes): An unsigned integer that specifies the number of built-in function categories in the workbook. The sum of **count**, the count of **FnGroupName** (section [2.4.120](#)) records and the count of **FnGrp12** (section [2.4.121](#)) records in the current workbook MUST be less than or equal to 256. The user-defined function categories include those defined in **FnGroupName** records and **FnGrp12** records. The value MUST be one of the following:

Value	Meaning
0x0E	<p>There are 14 built-in function categories in the workbook. This implies that the file was last saved by a specific version of the application 46.</p> <p>The following 9 built-in function categories are visible to the end-user: Financial, Date & Time, Math & Trig, Statistical, Lookup & Reference, Database, Text, Logical, Information.</p> <p>The following 5 built-in function categories are not visible to the end-user: UserDefined, Commands, Customize, MacroControl, DDEExternal.</p>
0x10	<p>There are 16 built-in function categories in the workbook. This implies that the file was last saved by a specific version of the application 47.</p> <p>The following 11 built-in function categories are visible to the end-user: Financial, Date & time, Math & Trig, Statistical, Lookup & Reference, Database, Text, Logical, Information, Engineering, Cube.</p> <p>The following 5 built-in function categories are not</p>

Value	Meaning
	visible to the end-user: UserDefined, commands, Customize, MacroControl, DDEExternal

2.4.31 CalcCount

The **CalcCount** record specifies the iteration count for a calculation in **iterative calculation** mode.

0	1	2	3	4	5	6	7	8	9	10	11	12	13	14	15	16	17	18	19	20	21	22	23	24	25	26	27	28	29	30	31
cIter																															

cIter (2 bytes): A signed integer that specifies the maximum number of iterations that can occur for a calculation in iterative calculation mode. MUST be greater than or equal to one and less than or equal to 32767.

2.4.32 CalcDelta

The **CalcDelta** record specifies the minimum value change required for **iterative calculation** to continue.

0	1	2	3	4	5	6	7	8	9	10	11	12	13	14	15	16	17	18	19	20	21	22	23	24	25	26	27	28	29	30	31
numDelta																															
...																															

numDelta (8 bytes): An Xnum (section [2.5.342](#)) value that specifies the amount of change in value for a given **cell** from the previously calculated value for that cell that MUST exist for the iteration to continue. The value MUST be greater than or equal to 0.

2.4.33 CalcIter

The **CalcIter** record specifies the state of **iterative calculation**.

0	1	2	3	4	5	6	7	8	9	10	11	12	13	14	15	16	17	18	19	20	21	22	23	24	25	26	27	28	29	30	31
vIter																															

vIter (2 bytes): A **Boolean** (section [2.5.14](#)) that specifies whether to enable iterative calculation.

If the value is 0, iterative calculation is disabled. If the value is 1, iterative calculation is enabled.

2.4.34 CalcMode

The **CalcMode** record specifies the **calculation mode** for the workbook.

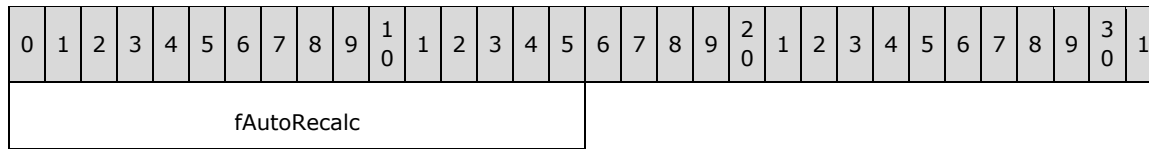

fAutoRecalc (2 bytes): A signed integer that specifies whether the calculation mode is automatic or manual.

The value MUST be one of the following:

Value	Meaning
0	Manual
1	Automatic
2	Automatic, except for tables

2.4.35 CalcPrecision

The **CalcPrecision** record specifies the calculation precision mode for the **workbook**.

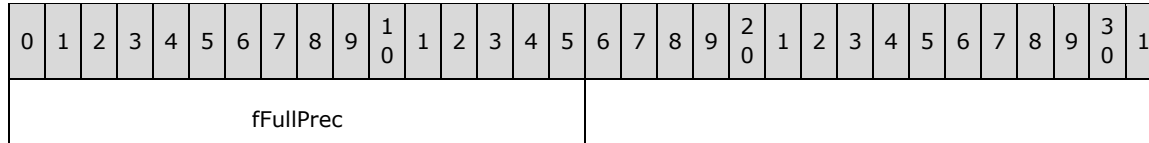

fFullPrec (2 bytes): A Boolean (section [2.5.14](#)) that specifies whether the **precision as displayed** mode is **selected**.

If the value is 0, the precision as displayed mode is selected. If the value is 1, the precision as displayed mode is not selected.

2.4.36 CalcRefMode

The **CalcRefMode** record specifies the **reference style** for the workbook.

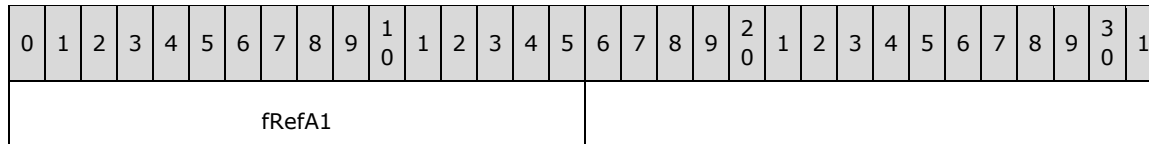

fRefA1 (2 bytes): A Boolean (section [2.5.14](#)) that specifies the reference style for all formulas.

If the value is 0, the mode is **R1C1**. If the value is 1, the mode is **A1**.

2.4.37 CalcSaveRecalc

The **CalcSaveRecalc** record specifies the recalculation behavior.

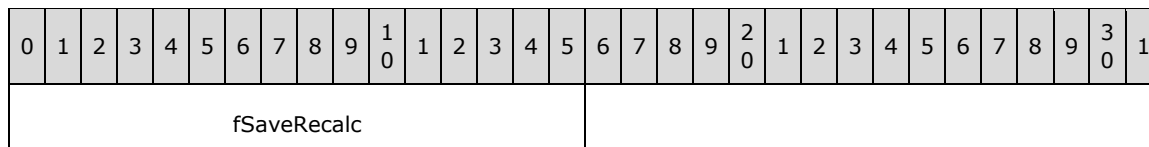

fSaveRecalc (2 bytes): A Boolean (section [2.5.14](#)) that specifies whether to **recalculate** the **workbook** before it is saved, when in manual **calculation mode**. If the value is 0, the workbook is not recalculated before it is saved. If the value is 1, the workbook is recalculated before it is saved.

2.4.38 CatLab

The **CatLab** record specifies the attributes of the [axis](#) label.

0	1	2	3	4	5	6	7	8	9	10	11	12	13	14	15	16	17	18	19	20	21	22	23	24	25	26	27	28	29	30	31
frtHeaderOld																															
wOffset																at															
A	unused															reserved (optional)															

frtHeaderOld (4 bytes): An [FrtHeaderOld](#) structure. The **frtHeaderOld.rt** field MUST be 0x0856.

wOffset (2 bytes): An unsigned integer that specifies the distance between the axis and axis label. It contains the offset as a percentage of the default distance. The default distance is equal to 1/3 the height of the **font** calculated in pixels. MUST be a value greater than or equal to 0 (0%) and less than or equal to 1000 (1000%).

at (2 bytes): An unsigned integer that specifies the alignment of the axis label. MUST be a value from the following table:

Value	Alignment
0x0001	Top-aligned if the trot field of the Text record of the axis is not equal to 0. Left-aligned if the iReadingOrder field of the Text record of the axis specifies left-to-right reading order ; otherwise, right-aligned.
0x0002	Center-alignment
0x0003	Bottom-aligned if the trot field of the Text record of the axis is not equal to 0. Right-aligned if the iReadingOrder field of the Text record of the axis specifies left-to-right reading order; otherwise, left-aligned.

A - cAutoCatLabelReal (1 bit): A bit that specifies whether the number of **categories (2)** between axis labels is set to the default value. MUST be a value from the following table:

Value	Description
0	The value is set to catLabel field as specified by CatSerRange record.
1	The value is set to the default value. The number of category (2) labels is automatically calculated by the application based on the data in the chart .

unused (15 bits): Undefined, and MUST be ignored.

reserved (2 bytes): MUST be zero, and MUST be ignored.

2.4.39 CatSerRange

The **CatSerRange** record specifies the properties of a **category (2) axis**, a date axis, or a [series](#) axis.

0	1	2	3	4	5	6	7	8	9	10	11	12	13	14	15	16	17	18	19	20	21	22	23	24	25	26	27	28	29	30	31			
catCross																catLabel																		
catMark																A	B	C	reserved															

catCross (2 bytes): A signed integer that specifies where the value axis crosses this axis, based on the following table. If **fMaxCross** is set to 1, the value this field MUST be ignored.

Axis Type	catCross Range
Category (2) axis	This field specifies the category (2) at which the value axis crosses. For example, if this field is 2, the value axis crosses this axis at the second category (2) on this axis. MUST be greater than or equal to 1 and less than or equal to 31999.
Series axis	MUST be 0.
Date axis	<p>catCross MUST be equal to the value given by the following formula:</p> $\text{catCross} = \text{catCrossDate} - \text{catMin} + 1$ <p>Where catCrossDate is the catCrossDate field of the AxcExt record and catMin is the catMin field of the AxcExt record.</p>

catLabel (2 bytes): A signed integer that specifies the interval between axis labels on this axis. MUST be greater than or equal to 1 and less than or equal to 31999. MUST be ignored for a date axis.

catMark (2 bytes): A signed integer that specifies the interval at which **major tick marks** and **minor tick marks** are displayed on the axis. Major tick marks and minor tick marks that would have been visible are hidden unless they are located at a multiple of this field. MUST be greater than or equal to 1, and less than or equal to 31999. MUST be ignored for a date axis.

A - fBetween (1 bit): A bit that specifies whether the value axis crosses this axis between major tick marks. MUST be a value from the following table:

Value	Meaning
0	The value axis crosses this axis on a major tick mark.
1	The value axis crosses this axis between major tick marks.

B - fMaxCross (1 bit): A bit that specifies whether the value axis crosses this axis at the last category (2), the last series, or the maximum date. MUST be a value from the following table:

Value	Meaning
0	The value axis crosses this axis at the value specified by catCross .
1	The value axis crosses this axis at the last category (2), the last series, or the maximum date.

C - fReverse (1 bit): A bit that specifies whether the axis is displayed in reverse order. MUST be a value from the following table:

Value	Meaning
0	The axis is displayed in order.
1	The axis is display in reverse order.

reserved (13 bits): MUST be zero, and MUST be ignored.

2.4.40 CbUsr

The **CbUsr** record specifies the size of each [UsrInfo](#) record stored as part of a [shared workbook](#).

0	1	2	3	4	5	6	7	8	9	10	11	12	13	14	15	16	17	18	19	20	21	22	23	24	25	26	27	28	29	30	31
rgCbUsr (512 bytes)																															
...																															
...																															

rgCbUsr (512 bytes): An array of 2-byte unsigned integers. Each element in the array specifies the byte count for the UsrInfo record whose index in the collection of UsrInfo records following CbUsr corresponds to the index of the element. Array elements with a zero-based index greater than or equal to the count of users specified in the **iCount** field in [CUsr](#) MUST be zero and MUST be ignored.

2.4.41 CellWatch

The **CellWatch** record specifies a reference to a **watched cell**.

0	1	2	3	4	5	6	7	8	9	10	11	12	13	14	15	16	17	18	19	20	21	22	23	24	25	26	27	28	29	30	31
frtRefHeaderU																															
...																															
...																															
reserved																															

frtRefHeaderU (12 bytes): An [FrtRefHeaderU](#) structure that specifies the **cell** to be watched. The **frtRefHeaderU.rt** field MUST be 0x086C. The **frtRefHeaderU.grbitFrft.FrtRef** MUST be 1. The **frtRefHeaderU.ref8** specifies the cell.

reserved (4 bytes): MUST be zero, and MUST be ignored.

2.4.42 CF

The **CF** record specifies a **conditional formatting** rule.

0	1	2	3	4	5	6	7	8	9	10	11	12	13	14	15	16	17	18	19	20	21	22	23	24	25	26	27	28	29	30	31
ct										cp										cce1											
cce2																rgbdfx (variable)															
...																															
rgce1 (variable)																															
...																															
rgce2 (variable)																															
...																															

ct (1 byte): An unsigned integer that specifies the type of condition. MUST be a value from the following table:

Value	Meaning
0x01	Apply the conditional formatting when the comparison function specified by cp applied to the cell value, rgce1 and rgce2 , evaluates to TRUE.
0x02	Apply the conditional formatting when the formula (section 2.2.2) specified by rgce1 evaluates to TRUE.

cp (1 byte): An unsigned integer that specifies the comparison function used when **ct** is equal to 0x01. In the following table, *v* represents the cell value, and *v1* and *v2* represent the results of evaluating the formulas specified by **rgce1** and **rgce2**. The value of this field MUST be a value from the following table:

Value	Apply the conditional formatting if
0x01	<i>v2</i> is greater than or equal to <i>v1</i> , and <i>v</i> is greater than or equal to <i>v1</i> and less than or equal to <i>v2</i> -Or- <i>v1</i> is greater than <i>v2</i> , and <i>v</i> is greater than or equal to <i>v2</i> and less than or equal to <i>v1</i>
0x02	<i>v2</i> is greater than or equal to <i>v1</i> , and <i>v</i> is less than <i>v1</i> or greater than <i>v2</i> -Or- <i>v1</i> is greater than <i>v2</i> , and <i>v</i> is less than <i>v2</i> or greater than <i>v1</i>
0x03	<i>v</i> is equal to <i>v1</i>
0x04	<i>v</i> is not equal to <i>v1</i>
0x05	<i>v</i> is greater than <i>v1</i>
0x06	<i>v</i> is less than <i>v1</i>

Value	Apply the conditional formatting if
0x07	v is greater than or equal to v1
0x08	v is less than or equal to v1

cce1 (2 bytes): An unsigned integer that specifies the size of **rgce1** in bytes. MUST be less than or equal to 16409.

cce2 (2 bytes): An unsigned integer that specifies the size of **rgce2** in bytes. MUST be zero when **ct** is equal to 0x02. MUST be zero when **ct** is equal to 0x01 and **cp** is greater than 0x02. MUST be less than or equal to 16409.

rgbdfx (variable): A [DXFN](#) structure that specifies the formatting to apply to a cell that fulfills the condition.

rgce1 (variable): A [CFParsedFormulaNoCCE](#) structure that specifies the first formula. If **ct** is equal to 0x01, this field is the first operand of the comparison. If **ct** is equal to 0x02, this formula is used to determine if the conditional formatting is applied. The size of **rgce1** in bytes MUST be equal to **cce1**.

rgce2 (variable): A [CFParsedFormulaNoCCE](#) structure that specifies the formula that is the second operand of the comparison if **ct** is equal to 0x01 and **cp** is either equal to 0x01 or 0x02. The size of **rgce2** in bytes MUST be equal to **cce2**.

2.4.43 CF12

The **CF12** record specifies a **conditional formatting** rule.

All CF12 records MUST follow a [CondFmt12](#) record, another CF12 record, or a [CFEx](#) record.

0	1	2	3	4	5	6	7	8	9	10	11	12	13	14	15	16	17	18	19	20	21	22	23	24	25	26	27	28	29	30	31
frtRefHeader																															
...																															
...																															
ct										cp										cce1											
cce2																dxf (variable)															
...																															
rgce1 (variable)																															
...																															
rgce2 (variable)																															
...																															

fmlaActive (variable)										
...										
A	B	C	D	E	ipriority					icfTemplate
...					cbTemplateParm		rgbTemplateParms (16 bytes)			
...										
...										
...					rgbCT (variable)					
...										

ftrRefHeader (12 bytes): An [FtrRefHeader](#). The **ftrRefHeader.rt** field MUST be 0x087A. The **ftrRefHeader.grbitFrt.fFtrRef** field MUST be zero. All of the fields of the **ftrRefHeader.ref8** structure MUST be zero and MUST be ignored.

ct (1 byte): An unsigned integer that specifies the type of condition. This field determines the type of the **rgbCT** field as specified in the following table. MUST be a value from the following table:

Value	Meaning
0x01	Apply the conditional formatting if the comparison operation specified by cp evaluates to TRUE rgbCT MUST be omitted.
0x02	Apply the conditional formatting if the formula (section 2.2.2) specified by rgce1 evaluates to TRUE. rgbCT MUST be omitted.
0x03	Use color scale formatting. rgbCT is a CFGradient .
0x04	Use data bar formatting. rgbCT is a CFDatabar .
0x05	Apply the conditional formatting when the cell value passes a filter specified in the rgbCT structure. rgbCT is a CFFilter .
0x06	Use icon set formatting rgbCT is a CFMultistate .

cp (1 byte): An unsigned integer that specifies the comparison **function** used when **ct** is equal to 0x01. In the following table, *v* represents the cell value, and *v1* and *v2* represent the results of evaluating **rgce1** and **rgce2**. The value of this field MUST be a value from the following table:

Value	Apply the conditional formatting if
0x01	<i>v2</i> is greater than or equal to <i>v1</i> , and <i>v</i> is greater than or equal to <i>v1</i> and less than or equal to <i>v2</i>

Value	Apply the conditional formatting if
	-Or- v1 is greater than v2, and v is greater than or equal to v2 and less than or equal to v1
0x02	v2 is greater than or equal to v1, and v is less than v1 or greater than v2 -Or- v1 is greater than v2, and v is less than v2 or greater than v1
0x03	v is equal to v1
0x04	v is not equal to v1
0x05	v is greater than v1
0x06	v is less than v1
0x07	v is greater than or equal to v1
0x08	v is less than or equal to v1

ct (2 bytes): An unsigned integer that specifies the size of **rgce1** in bytes. MUST be zero unless **ct** is equal to 0x01 or 0x02. MUST be less than or equal to 16409.

ct (2 bytes): An unsigned integer that specifies the size of **rgce2** in bytes. MUST be zero unless **ct** is equal to 0x01 and **cp** is equal to 0x01 or 0x02. MUST be less than or equal to 16409.

dx (variable): A [DXFN12](#) that specifies the formatting to apply to a cell that fulfills the condition. If **ct** is equal to 0x03, 0x04 or 0x06, then **dx.cbDxf** MUST be equal to 0x00000000.

rgce1 (variable): A [CFParsedFormulaNoCCE](#) that specifies the formula used to evaluate the first operand in a comparison when **ct** is 0x01. If **ct** is 0x02 **rgce1** MUST be a Boolean function.

rgce2 (variable): A [CFParsedFormulaNoCCE](#) that specifies the formula used to evaluate the second operand of the comparison when **ct** is 0x01 and **cp** is either 0x01 or 0x02.

fmlaActive (variable): A [CFParsedFormula](#) that specifies the formula that specifies an activity condition for the color scale, data bar and icon set formatting rule types. If **ct** is equal to 0x03, 0x04 or 0x06, then the conditional formatting is applied if **fmlaActive** evaluates to TRUE.

A - unused1 (1 bit): Undefined and MUST be ignored.

B - fStopIfTrue (1 bit): A bit that specifies whether, when a cell fulfills the condition corresponding to this rule, the lower priority conditional formatting rules that apply to this cell are evaluated. MUST be one of the following values:

Value	Meaning
0x0	Evaluate lower priority conditional formatting rules that apply to this cell
0x1	If the cell fulfills the condition corresponding to this rule, do not evaluate lower priority conditional formatting rules that apply to this cell

MUST be zero when **ct** is equal to 0x03, 0x04 or 0x06.

C - reserved1 (2 bits): MUST be zero and MUST be ignored.

D - unused2 (1 bit): Undefined and MUST be ignored.

E - reserved2 (3 bits): MUST be zero and MUST be ignored.

ipriority (2 bytes): An unsigned integer that specifies the priority of the rule. Rules that apply to the same cell are evaluated in increasing order of **ipriority**. MUST be unique across all CF12 records and [CFExNonCF12](#) structures in the [worksheet](#) substream.

icfTemplate (2 bytes): An unsigned integer that specifies the **template** from which the rule was created. MUST be a value from the following table:

Value	Meaning
0x0000	Cell value
0x0001	Formula
0x0002	Color scale formatting
0x0003	Data bar formatting
0x0004	Icon set formatting
0x0005	Filter
0x0007	Unique values
0x0008	Contains text
0x0009	Contains blanks
0x000A	Contains no blanks
0x000B	Contains errors
0x000C	Contains no errors
0x000F	Today
0x0010	Tomorrow
0x0011	Yesterday
0x0012	Last 7 days
0x0013	Last month
0x0014	Next month
0x0015	This week
0x0016	Next week
0x0017	Last week
0x0018	This month
0x0019	Above average
0x001A	Below Average
0x001B	Duplicate values
0x001D	Above or equal to average
0x001E	Below or equal to average

cbTemplateParm (1 byte): An unsigned integer that specifies the size of the **rgbTemplateParms** field in bytes. MUST be 16.

rgbTemplateParms (16 bytes): A [CFExTemplateParams](#) that specifies the parameters for the rule.

rgbCT (variable): A field that specifies the parameters of this rule. The type of **rgbCT** depends on the value of **ct**.

2.4.44 CFEx

The **CFEx** record extends a [CondFmt](#).

0	1	2	3	4	5	6	7	8	9	10	11	12	13	14	15	16	17	18	19	20	21	22	23	24	25	26	27	28	29	30	31
ftrRefHeaderU																															
...																															
...																															
fIsCF12																															
nID																rgbContent (variable)															
...																															

ftrRefHeaderU (12 bytes): An [FtrRefHeaderU](#) structure. The **ftrRefHeaderU.rt** field MUST be 0x087B. The **ftrRefHeaderU.grbitFrt.fFrtRef** MUST be 1. The **ftrRefHeaderU.ref8** MUST be equal to the **sqref** field of the associated CondFmt record specified by **nID**.

fIsCF12 (4 bytes): A Boolean (section [2.5.14](#)) that specifies what type of rule this record extends. MUST be one of the following values:

Value	Meaning
0x00000000	This record extends a rule specified by a CF record and MUST NOT be followed by a CF12 record.
0x00000001	This record extends a rule specified by a CF12 record and MUST be followed by the CF12 record it extends.

nID (2 bytes): An unsigned integer that specifies which CondFmt record is being extended. It MUST be equal to the **nID** field of one of the CondFmt records in the [Worksheet](#) substream.

rgbContent (variable): A [CFExNonCF12](#) structure that specifies the extensions to an existing CF record. MUST be omitted when **fIsCF12** is not equal to 0x00.

2.4.45 Chart

The **Chart** record specifies the position and size of the **chart area** (section [2.2.3.17](#)) and specifies the beginning of a collection of records as defined by the [Chart Sheet Substream ABNF](#). The collection of records specifies a [chart](#). The position information MUST be ignored if the chart is embedded in a sheet.

0	1	2	3	4	5	6	7	8	9	10	11	12	13	14	15	16	17	18	19	20	21	22	23	24	25	26	27	28	29	30	31
x																															
y																															
dx																															
dy																															

x (4 bytes): A FixedPoint as specified in [MS-OSHARED] section 2.2.1.6 that specifies the horizontal position of the upper-left corner of the chart in **points**. SHOULD<48> be greater than or equal to zero.

y (4 bytes): A FixedPoint as specified in [MS-OSHARED] section 2.2.1.6 that specifies the vertical position of the upper-left corner of the chart in points. SHOULD<49> be greater than or equal to zero.

dx (4 bytes): A FixedPoint as specified in [MS-OSHARED] section 2.2.1.6 that specifies the width in points. SHOULD<50> be greater than or equal to zero.

dy (4 bytes): A FixedPoint as specified in [MS-OSHARED] section 2.2.1.6 that specifies the height in points. SHOULD<51> be greater than or equal to zero.

2.4.46 Chart3d

The **Chart3d** record specifies that the **plot area** of the **chart group** is rendered in a 3-D scene and also specifies the attributes of the 3-D plot area. The preceding chart group type MUST be of type bar, pie, line, area, or surface.

0	1	2	3	4	5	6	7	8	9	10	11	12	13	14	15	16	17	18	19	20	21	22	23	24	25	26	27	28	29	30	31				
anRot																anElev																			
pcDist																pcHeight																			
pcDepth																pcGap																			
A	B	C	D	E	F	reserved2																													

anRot (2 bytes): A signed integer that specifies the clockwise rotation, in degrees, of the 3-D plot area around a vertical line through the center of the 3-D plot area. MUST be greater than or equal to 0 and MUST be less than or equal to 360. If chart group type is bar and the value of field **fTranspose** in the record **Bar** is 1, then MUST be less than or equal to 44.

anElev (2 bytes): A signed integer that specifies the rotation, in degrees, of the 3-D plot area around a horizontal line through the center of the 3-D plot area. MUST be greater than or equal to -90 and MUST be less than or equal to 90. If the chart group type is bar and the value of field **fTranspose** in the record **Bar** is 1, or the chart group type is pie then MUST be greater than or equal to 0. If the chart group type is bar and the value of field **fTranspose** in the record **Bar** is 1, then the value MUST be less than or equal to 44.

pcDist (2 bytes): A signed integer that specifies the field of view angle for the 3-D plot area. MUST be greater than or equal to zero and less than 200. SHOULD<52> be less than or equal to 100.

pcHeight (2 bytes): If **fNotPieChart** is 0, then this is an unsigned integer that specifies the thickness of the pie for a pie chart group. If **fNotPieChart** is 1, then this is a signed integer that specifies the height of the 3-D plot area as a percentage of its width. SHOULD<53> be greater than or equal to 5, MUST be less than 65535 and SHOULD<54> be less than or equal to 500.

pcDepth (2 bytes): A signed integer that specifies the depth of the 3-D plot area as a percentage of its width. MUST be greater than or equal to 1 and less than or equal to 2000.

pcGap (2 bytes): An unsigned integer that specifies the width of the gap between the **series** and the front and back edges of the 3-D plot area as a percentage of the **data point** depth divided by 2. If

fCluster is not 1 and chart group type is not a bar then **pcGap** also specifies distance between adjacent series as a percentage of the data point depth. MUST be less than or equal to 500.

A - fPerspective (1 bit): A bit that specifies whether the 3-D plot area is rendered with a vanishing point. If **fNotPieChart** is 0 the value MUST be 0. If **fNotPieChart** is 1 then the value MUST be a value from the following table:

Value	Meaning
0	No vanishing point applied.
1	Perspective vanishing point applied based on value of pcDist .

B - fCluster (1 bit): A bit that specifies whether data points are clustered together in a bar chart group. If chart group type is not bar or pie, value MUST be ignored. If chart group type is pie, value MUST be 0. If chart group type is bar, then the value MUST be a value from the following table:

Value	Meaning
0	Data points are not clustered.
1	Data points are clustered.

C - f3DScaling (1 bit): A bit that specifies whether the height of the 3-D plot area is automatically determined. If **fNotPieChart** is 0 then this MUST be 0. If **fNotPieChart** is 1 then the value MUST be a value from the following table:

Value	Meaning
0	The value of pcHeight is used to determine the height of the 3-D plot area
1	The height of the 3-D plot area is automatically determined

D - reserved1 (1 bit): MUST be zero, and MUST be ignored.

E - fNotPieChart (1 bit): A bit that specifies whether the chart group type is pie. MUST be a value from the following table:

Value	Meaning
0	Chart group type MUST be pie.
1	Chart group type MUST NOT be pie.

F - fWalls2D (1 bit): A bit that specifies whether the **walls** are rendered in 2-D<55>. If **fPerspective** is 1 then this MUST be ignored. If the chart group type is not bar, area or pie this MUST be ignored. If the chart group is of type bar and **fCluster** is 0, then this MUST be ignored. If the chart group type is pie this MUST be 0 and MUST be ignored. If the chart group type is bar or area, then the value MUST be a value from the following table:

Value	Meaning
0	Chart walls and floor are rendered in 3D.
1	Chart walls are rendered in 2D and the chart floor is not rendered.

reserved2 (10 bits): MUST be zero, and MUST be ignored.

2.4.47 Chart3DBarShape

The **Chart3DBarShape** record specifies the shape of the [data points](#) in a bar or column [chart group](#). This record is only used for a bar or column chart group and MUST be ignored for all other chart groups. This record MUST be ignored if the current substream does not contain a [Chart3d](#) record.

0	1	2	3	4	5	6	7	8	9	10	11	12	13	14	15	16	17	18	19	20	21	22	23	24	25	26	27	28	29	30	31
riser										taper																					

riser (1 byte): A Boolean (section [2.5.14](#)) that specifies the shape of the base of the data points in a bar or column chart group. MUST be a value from the following table:

Value	Meaning
0x00	The base of the data point is a rectangle.
0x01	The base of the data point is an ellipse.

taper (1 byte): An unsigned integer that specifies how the data points in a bar or column chart group taper from base to tip. MUST be a value from the following table:

Value	Meaning
0x00	The data points of the bar or column chart group do not taper. The shape at the maximum value of the data point is the same as the shape at the base.
0x01	The data points of the bar or column chart group taper to a point at the maximum value of each data point.
0x02	The data points of the bar or column chart group taper towards a projected point at the position of the maximum value of all of the data points in the chart group, but are clipped at the value of each data point.

2.4.48 ChartFormat

The **ChartFormat** record specifies properties of a [chart group](#) and specifies the beginning of a collection of records as defined by the [Chart Sheet Substream ABNF](#). The collection of records specifies a chart group.

0	1	2	3	4	5	6	7	8	9	10	11	12	13	14	15	16	17	18	19	20	21	22	23	24	25	26	27	28	29	30	31
reserved1																															
reserved2																															
reserved3																															
reserved4																															
A	reserved5															icrt															

reserved1 (4 bytes): MUST be zero, and MUST be ignored.

reserved2 (4 bytes): MUST be zero, and MUST be ignored.

reserved3 (4 bytes): MUST be zero, and MUST be ignored.

reserved4 (4 bytes): MUST be zero, and MUST be ignored.

A - fVaried (1 bit): A bit that specifies whether the color for each [data point](#) and the color and type for each **data marker** varies. If the chart group has multiple [series](#), or the chart group has one series and the type is either a surface, stock, or area chart group, then this field MUST be ignored, and the data points do not vary. For all other chart group types, if the chart group has one series, then a value of 0x1 specifies that the data points vary. MUST be a value from the following table:

Value	Meaning
0x0	The color for each data point and the color and type for each data marker does not vary.
0x1	The color for data points or the color or type for data markers varies.

reserved5 (15 bits): MUST be zero, and MUST be ignored.

icrt (2 bytes): An unsigned integer that specifies the drawing order of the chart group relative to the other chart groups, where 0x0000 is the bottom of the **z-order**. This value MUST be unique for each instance of this record and MUST be less than or equal to 0x0009.

2.4.49 ChartFrtInfo

The **ChartFrtInfo** record specifies the versions of the application that originally created and last saved the file, and the [Future Record](#) identifiers that are used in the file. This property was introduced by a version of the application [<56>](#) as a Future Record for a [chart](#).

In a file written by some versions of the application [<57>](#), this record appears before the end of the [Chart](#) record block and before any other Future Record in the record stream. This record does not exist in a file created by certain versions of the application [<58>](#), but appears after the [End](#) record of the Chart record block in a file updated by other versions of the application [<59>](#), in which case the **verWriter** field MUST be a certain version of the application [<60>](#) regardless of the actual value in the record.

If a [CrtMIFrt](#) record exists in a sequence of records that conforms to the [CRTMLFRT](#) rule of the chart sheet substream, then this record MUST immediately precede the sequence of records that conforms to the [PAGESETUP](#) rule for the chart sheet substream. Otherwise, it MUST immediately precede the first chart-specific future record, which is a [record](#) that has a record number greater than or equal to 2048 and less than or equal to 2303 according to [Record Enumeration](#).

0	1	2	3	4	5	6	7	8	9	10	1	2	3	4	5	6	7	8	9	20	1	2	3	4	5	6	7	8	9	30	1
frtHeaderOld																															
verOriginator										verWriter										cCFRTID											
rgCFRTID (variable)																															
...																															

frtHeaderOld (4 bytes): An [FrtHeaderOld](#) structure. The **frtHeaderOld.rt** field MUST be 0x0850.

verOriginator (1 byte): An unsigned integer that specifies the application version that originally created the file. MUST be a value from the following table:

Value	Meaning
0x9	Specifies the application version <61>
0xA	Specifies the application version <62>
0xC	Specifies the application version <63>
0xE	Specifies the application version <64>
0xF	Specifies the application version <65>

verWriter (1 byte): An unsigned integer that specifies the application version that last saved the file. MUST be a value from the following table:

Value	Meaning
0x9	Specifies the application version <66>
0xA	Specifies the application version <67>
0xC	Specifies the application version <68>
0xE	Specifies the application version <69>
0xF	Specifies the application version <70>

cfFRTID (2 bytes): An unsigned integer that specifies the number of elements in **rgCFRTID**. The value depends on the value in **verWriter**. It MUST be 0x1 if **verWriter** is 0x9; 0x3 if **verWriter** is 0xA; 0x4 if **verWriter** is 0xC or 0xE.

rgCFRTID (variable): An array of [CFrtId](#) structures. This field specifies the range of Future Record Type identifiers used in the chart. The range of values is determined by the value of **verWriter** as specified in the following table:

verWriter value	Value range(first,last)
0x9	0x0850, 0x085A
0xA	0x0850, 0x085A 0x0861, 0x0861 0x086A, 0x086B
0xC or 0xE	0x0850, 0x085A 0x0861, 0x0861 0x086A, 0x086B 0x089D, 0x08A6

2.4.50 ClrtClient

The **ClrtClient** record specifies a **custom color palette** for a chart.

0	1	2	3	4	5	6	7	8	9	10	1	2	3	4	5	6	7	8	9	20	1	2	3	4	5	6	7	8	9	30	1
ccv																	rgColor (variable)														

...

ccv (2 bytes): A signed integer that specifies the number of colors in the **rgColor** array. The value MUST be 3.

rgColor (variable): An array of [LongRGB](#) structures. The array specifies the colors of the **color palette**. The elements MUST contain the following values:

Index	Element	Value
0	Foreground color	This value MUST be equal to the system window text color.
1	Background color	This value MUST be equal to the system window color.
2	Neutral color	This value MUST be black.

2.4.51 CodeName

The **CodeName** record specifies the name of a **workbook** object, a sheet object in the **VBA project** located in this file. If this record is in the [Globals Substream](#), the name is for the workbook object. If this record is in a [Chart Sheet Substream](#), the name is for the **chart sheet** object representing the sheet. If this record is in a [Macro Sheet Substream](#), the name is for the **macro sheet** object representing the sheet. If this record is in a [Dialog Sheet Substream](#), the name is for the **dialog sheet** object representing the sheet. If this record is in a [Worksheet Substream](#), the name is for the **worksheet** object representing the sheet.

0	1	2	3	4	5	6	7	8	9	10	11	12	13	14	15	16	17	18	19	20	21	22	23	24	25	26	27	28	29	30	31
codeName (variable)																															
...																															

codeName (variable): An [XLUnicodeString](#) structure that specifies the name used to identify the workbook object or sheet object in the VBA project embedded in this file. The value of **codename.cch** MUST be less than or equal to 31.

If this string is not empty, it MUST contain only the characters that can be mapped from **Unicode** to a multiple-byte **ANSI character set** specified by the system **locale**. If the system locale is Chinese, Japanese, or Korean, then the full-width characters in the resulting ANSI string are further mapped to corresponding half-width characters where applicable.

In the resulting ANSI string, the first character MUST be a letter, a single-byte character with a code greater than 0x7F, or multiple-byte character. The subsequent characters in the resulting ANSI string MUST be a digit, an underscore, a single-byte character with a code greater than 0x7F, or a multiple-byte character.

If the system locale is Japanese, the original Unicode string MUST NOT contain a character with a code equal to 0xFFE3.

2.4.52 CodePage

The **CodePage** record specifies **code page** information for the **workbook**.

0	1	2	3	4	5	6	7	8	9	10	11	12	13	14	15	16	17	18	19	20	21	22	23	24	25	26	27	28	29	30	31
cv																															

cv (2 bytes): An unsigned integer that specifies the workbook's code page. The value MUST be one of the code page values specified in [\[CODEPAGE\]](#) or the special value 1200, which means that the workbook is **Unicode**.

2.4.53 ColInfo

The **ColInfo** record specifies the column formatting for a **range** of columns.

0	1	2	3	4	5	6	7	8	9	10	11	12	13	14	15	16	17	18	19	20	21	22	23	24	25	26	27	28	29	30	31
colFirst																colLast															
coldx																ixfe															
A	B	C	D	E			F	G	H	I	unused2																				

colFirst (2 bytes): A [Col256U](#) structure that specifies the first formatted column.

colLast (2 bytes): A [Col256U](#) structure that specifies the last formatted column. The value MUST be greater than or equal to **colFirst**.

coldx (2 bytes): An unsigned integer that specifies the column width in units of 1/256th of a character width. Character width is defined as the maximum digit width of the numbers 0, 1, 2, ... 9 as rendered in the [Normal style's font](#).

ixfe (2 bytes): An [IXFCell](#) structure that specifies the default format for the column cells.

A - fHidden (1 bit): A bit that specifies whether the column range defined by **colFirst** and **colLast** is **hidden**.

B - fUserSet (1 bit): A bit that specifies that the column width was either manually set by the user or is different from the default column width as specified by [DefColWidth](#). If the value is 1, the column width was manually set or is different from [DefColWidth](#).

C - fBestFit (1 bit): A bit that specifies whether the column range defined by **colFirst** and **colLast** is set to "best fit." "Best fit" implies that the column width resizes based on the **cell** contents, and that the column width does not equal the default column width as specified by [DefColWidth](#).

D - fPhonetic (1 bit): A bit that specifies whether **phonetic information** is displayed by default for the column range defined by **colFirst** and **colLast**.

E - reserved1 (4 bits): MUST be zero, and MUST be ignored.

F - iOutLevel (3 bits): An unsigned integer that specifies the **outline level** of the column range defined by **colFirst** and **colLast**.

G - unused1 (1 bit): Undefined and MUST be ignored.

H - fCollapsed (1 bit): A bit that specifies whether the column range defined by **colFirst** and **colLast** is in a **collapsed outline state**.

I - reserved2 (3 bits): MUST be zero, and MUST be ignored.

unused2 (2 bytes): Undefined and MUST be ignored.

2.4.54 Compat12

The **Compat12** record specifies whether to check for compatibility with earlier application versions when saving the **workbook** from a version of the application <71> to the binary formats of other versions of the application <72>.

0	1	2	3	4	5	6	7	8	9	10	11	12	13	14	15	16	17	18	19	20	21	22	23	24	25	26	27	28	29	30	31
frtHeader																															
...																															
...																															
fNoCompatChk																															

frtHeader (12 bytes): An [FrtHeader](#) structure. The **frtHeader.rt** field MUST be 0x088C.

fNoCompatChk (4 bytes): A Boolean (section [2.5.14](#)) that specifies whether to check compatibility with earlier versions when saving the workbook. The value MUST be one of the following:

Value	Meaning
0x0000	When saving the workbook to a binary format of a version of the application <73>, the user is given the message that some newer features could be lost during the save and prompted to continue or cancel the save.
0x0001	When saving the workbook to a binary format of a version of the application <74>, the user is given no message or prompt before the workbook is saved.

2.4.55 CompressPictures

The **CompressPictures** record specifies a recommendation for picture compression when saving.

0	1	2	3	4	5	6	7	8	9	10	11	12	13	14	15	16	17	18	19	20	21	22	23	24	25	26	27	28	29	30	31
frtHeader																															
...																															
...																															
fAutoCompressPictures																															

frtHeader (12 bytes): An [FrtHeader](#) structure. The **frtHeader.rt** field MUST be 0x89B.

fAutoCompressPictures (4 bytes): A Boolean (section [2.5.14](#)) that specifies whether picture compression is recommended. MUST be a value from the following table:

Value	Meaning
0x00000000	Compression is not recommended.
0x00000001	Compression is recommended.

2.4.56 CondFmt

The **CondFmt** record specifies **conditional formatting** rules that are associated with a set of **cells**.

This record specifies the beginning of a collection of **CF** records as defined in the [Worksheet Substream ABNF](#). The collection of CF records specifies conditional formatting rules.

0	1	2	3	4	5	6	7	8	9	10	11	12	13	14	15	16	17	18	19	20	21	22	23	24	25	26	27	28	29	30	31
ccf																A	nID														
refBound																															
...																															
sqref (variable)																															
...																															

ccf (2 bytes): An unsigned integer that specifies the count of CF records that follow this record. MUST be greater than or equal to 0x0001, and less than or equal to 0x0003.

A - fToughRecalc (1 bit): A bit that specifies that the appearance of the cell requires significant processing. This information can be used to optimize the redraw of conditional formatting when data values change.

For example, an application could determine that a conditional formatting rule that contains certain functions or a conditional formatting rule that takes more than a predetermined amount of time to calculate designates that the conditional formatting requires significant processing, and could set this bit to 1.

nID (15 bits): An unsigned integer that identifies this record. The [CFEx](#) record uses this identifier to specify which CondFmt it extends.

refBound (8 bytes): A [Ref8U](#) structure that specifies the bounds of the set of cells to which the conditional formatting rules apply. The set of cells that this field represents MUST include all of the cells represented by the **sqref** field.

sqref (variable): A [SqRefU](#) structure that specifies the cells to which the conditional formatting rules apply. **sqref.cref** MUST be greater than zero and less than or equal to 1026.

2.4.57 CondFmt12

The **CondFmt12** record specifies **conditional formatting** rules that are associated with a set of **cells**, when all the rules are specified using [CF12](#) records.

This record specifies the beginning of a collection of CF12 records as defined in the [Worksheet Substream ABNF](#).

This record MUST be followed by the number of CF12 records specified by **mainCF.ccf**

0	1	2	3	4	5	6	7	8	9	10	1	2	3	4	5	6	7	8	9	20	1	2	3	4	5	6	7	8	9	30	1
frtRefHeaderU																															
...																															
...																															
mainCF (variable)																															
...																															

frtRefHeaderU (12 bytes): An [FrtRefHeaderU](#) structure. The **frtRefHeaderU.rt** field MUST be 0x0879. The **frtRefHeaderU.grbitFrftFrftRef** field MUST be 1. Each field of the **frtRefHeaderU.ref8** structure MUST be equal to the corresponding field of the **mainCF.refBound** structure.

mainCF (variable): A [CondFmtStructure](#) structure that specifies properties of a set of conditional formatting rules.

2.4.58 Continue

The **Continue** record specifies a continuation of the data in a preceding record. Records with data longer than 8,224 bytes MUST be split into several records. The first section of the data appears in the base record and subsequent sections appear in one or more **Continue** records that appear after the base record. Records with data shorter than 8,225 bytes can also store data in the base record and following **Continue** records. For example, the size of [TxO](#) record is less than 8,225 bytes, but it is followed by **Continue** records that store the string data and **formatting runs**.

0	1	2	3	4	5	6	7	8	9	10	1	2	3	4	5	6	7	8	9	20	1	2	3	4	5	6	7	8	9	30	1
continue (variable)																															
...																															

continue (variable): A binary stream that specifies the structure data. The number of bytes in this stream MUST be less than 8225.

2.4.59 ContinueBigName

The **ContinueBigName** record specifies a continuation of the data in a preceding [BigName](#) record.

0	1	2	3	4	5	6	7	8	9	10	1	2	3	4	5	6	7	8	9	20	1	2	3	4	5	6	7	8	9	30	1
continue (variable)																															
...																															

continue (variable): A binary stream that specifies the structure data. The number of bytes in this stream MUST be less than 8225.

2.4.60 ContinueFrt

The **ContinueFrt** record specifies a continuation of the data in a preceding [Future Record Type](#) record that has data longer than 8,224 bytes. Such records are split into several records. The first section of the data appears in the base record and subsequent sections appear in one or more **ContinueFrt** records that appear after the base record. How the data is split varies for different types of records. The base record can have data size shorter than 8,224 bytes after splitting. [SXTM](#) is such an example. The preceding base record MUST contain an [FrtHeaderOld](#) or an [FrtHeader](#) field.

0	1	2	3	4	5	6	7	8	9	10	11	12	13	14	15	16	17	18	19	20	21	22	23	24	25	26	27	28	29	30	31
frtHeaderOld																															
rgb (variable)																															
...																															

frtHeaderOld (4 bytes): An FrtHeaderOld structure. The **frtHeaderOld.rt** field MUST be 0x0812.

rgb (variable): A binary stream that specifies the record data. The number of bytes in this stream MUST be less than 8,221.

2.4.61 ContinueFrt11

The **ContinueFrt11** record specifies a continuation of the data in a preceding [Future Record Type](#) record that has data longer than 8,224 bytes. Such records are split into several records. The first section of the data appears in the base record and subsequent sections appear in one or more **ContinueFrt11** records that appear after the base record. The preceding base record MUST contain a [FrtRefHeaderU](#) field.

0	1	2	3	4	5	6	7	8	9	10	11	12	13	14	15	16	17	18	19	20	21	22	23	24	25	26	27	28	29	30	31
frtHeader																															
...																															
...																															
rgb (variable)																															
...																															

frtHeader (12 bytes): An [FrtHeader](#) structure. The **frtHeader.rt** field MUST be 0x0875.

rgb (variable): A binary stream that specifies the record data. The number of bytes in this stream MUST be less than 8,213.

2.4.62 ContinueFrt12

The **ContinueFrt12** record specifies a continuation of the data in a preceding [Future Record Type](#) record that has data longer than 8,224 bytes. Such records are split into several records. The first section of the data appears in the base record and subsequent sections appear in one or more **ContinueFrt12** records that appear after the base record. The preceding base record **MUST** contain a [FrtRefHeader](#) or a [FrtHeader](#) field.

0	1	2	3	4	5	6	7	8	9	10	1	2	3	4	5	6	7	8	9	20	1	2	3	4	5	6	7	8	9	30	1
frtRefHeader																															
...																															
...																															
rgb (variable)																															
...																															

frtRefHeader (12 bytes): An FrtRefHeader structure. The **frtRefHeader.rt** field **MUST** be 0x087F. If **frtRefHeader.grbitFrt.fFrtRef** is 1 then the **frtRefHeader.ref8** **MUST** refer to the **range** of cells associated with this record. If **frtRefHeader.grbitFrt.fFrtRef** is 0 then all of the fields of the **frtRefHeader.ref8** structure **MUST** be zero and **MUST** be ignored.

rgb (variable): A binary stream that specifies the record data. The number of bytes in this stream **MUST** be less than 8,213.

2.4.63 Country

The **Country** record specifies **locale** information for a **workbook**.

0	1	2	3	4	5	6	7	8	9	10	1	2	3	4	5	6	7	8	9	20	1	2	3	4	5	6	7	8	9	30	1
iCountryDef																iCountryWinIni															

iCountryDef (2 bytes): An unsigned integer that specifies the country/region code determined by the locale in effect when the workbook was saved. **MUST** be greater than or equal to 1 and less than or equal to 981 and **MUST** be a value from the table in **iCountryWinIni**.

iCountryWinIni (2 bytes): An unsigned integer that specifies the system **regional settings** country/region code in effect when the workbook was saved. **MUST** greater than or equal to 1 and less than or equal to 981 and **MUST** be a value from the table of Country/Region codes in this section.

Country/Region codes are defined as follows:

Code	Country/Region
1	United States
2	Canada
3	Latin America, except Brazil
7	Russia
20	Egypt

Code	Country/Region
30	Greece
31	Netherlands
32	Belgium
33	France
34	Spain
36	Hungary
39	Italy
41	Switzerland
43	Austria
44	United Kingdom
45	Denmark
46	Sweden
47	Norway
48	Poland
49	Germany
52	Mexico
55	Brazil
61	Australia
64	New Zealand
66	Thailand
81	Japan
82	Korea
84	Viet Nam
86	People's Republic of China
90	Turkey
213	Algeria
216	Morocco
218	Libya
351	Portugal
354	Iceland
358	Finland
420	Czech Republic
886	Taiwan
961	Lebanon
962	Jordan
963	Syria
964	Iraq
965	Kuwait
966	Saudi Arabia
971	United Arab Emirates
972	Israel
974	Qatar
981	Iran

2.4.64 CrErr

The **CrErr** record specifies the errors detected during crash recovery of a **workbook**.

0	1	2	3	4	5	6	7	8	9	10	11	12	13	14	15	16	17	18	19	20	21	22	23	24	25	26	27	28	29	30	31
frtHeader																															
...																															
...																															
cb																															
cch																rgch (variable)															
...																															

frtHeader (12 bytes): An [FrtHeader](#) structure. The **frtHeader.rt** field MUST be 0x0865.

cb (4 bytes): An unsigned integer that specifies the fixed size of this record. MUST be set to 0x0013.

cch (2 bytes): An unsigned integer that specifies the number of characters in the crash recovery error message stored in the **rgch** field. MUST be greater than zero.

rgch (variable): An [XLUnicodeString](#) structure that specifies the localized text of a crash recovery error message. If the **cch** field is greater than 8211 this record MUST be followed by one or more [Continue](#) records, which specify the continuation of the crash recovery error message. If the text is extended with Continue records a value from the table for **rgch.fHighByte** MUST be specified in the first byte of the **continue** field of the Continue record followed by the remaining portions of the text.

2.4.65 CRN

The **CRN** record specifies the values of **cells** in a sheet in an [external cell cache](#).

0	1	2	3	4	5	6	7	8	9	10	11	12	13	14	15	16	17	18	19	20	21	22	23	24	25	26	27	28	29	30	31
colLast										colFirst										row											
crnOper (variable)																															
...																															

colLast (1 byte): A [ColByteU](#) structure that specifies the zero-based column index of the last cell whose value is contained within this record. MUST be greater than or equal to the value of **colFirst**.

colFirst (1 byte): A [ColByteU](#) structure that specifies the zero-based column index of the first cell whose value is contained within this record. MUST be less than or equal to the value of **colLast**.

row (2 bytes): A [RwU](#) structure that specifies the zero-based row index of the cells whose values are contained within this record.

crnOper (variable): An array of [SerAr](#) structures that specifies the cell values for the cells in the row starting at **colFirst**. The number of elements in this array MUST equal the following formula:

$$\text{colLast} - \text{colFirst} + 1$$

2.4.66 CrtLayout12

The **CrtLayout12** record specifies the layout information for [attached label](#), when contained in the sequence of records that conforms to the [ATTACHEDLABEL](#) rule, or [legend](#), when contained in the sequence of records that conforms to the LD rule.

0	1	2	3	4	5	6	7	8	9	10	11	12	13	14	15	16	17	18	19	20	21	22	23	24	25	26	27	28	29	30	31
frtHeader																															
...																															
...																															
dwChecksum																															
A	B		reserved1																wXMode												
wYMode																wWidthMode															
wHeightMode																x															
...																															
...																y															
...																															
...																dx															
...																															
...																dy															
...																															
...																reserved2															

frtHeader (12 bytes): An [FrtHeader](#) structure. The **frtHeader.rt** field MUST be 0x089D.

dwChecksum (4 bytes): An unsigned integer that specifies the **checksum** of the values in the order as follows, if the checksum is incorrect, the layout information specified in this record MUST be ignored.

Checksum for type	Values
AttachedLabel	1. x1 field of the Pos record in the sequence of records that contains this

Checksum for type	Values
	<p>CrtLayout12 record and conforms to the ATTACHEDLABEL rule.</p> <ol style="list-style-type: none"> y1 field of the Pos record in the in the sequence of records that contains this CrtLayout12 record and conforms to the ATTACHEDLABEL rule. An unsigned integer that specifies whether the attached label is at its default position. MUST be 1 if the dip field of the Text record in the in the sequence of records that contains this CrtLayout12 record and conforms to the ATTACHEDLABEL rule is equal to 0xA. Otherwise, MUST be zero.
Legend	<ol style="list-style-type: none"> x1 field of the Pos record in the in the sequence of records that contains this CrtLayout12 record and conforms to the LD rule. y1 field of the Pos record in the in the sequence of records that contains this CrtLayout12 record and conforms to the LD rule. Width of the legend in pixels. Height of the legend in pixels. The fAutoPosX field of Legend record. The fAutoPosY field of Legend record. The fAutoSize of the Frame record in the in the sequence of records that contains this CrtLayout12 record and conforms to the LD rule.

The checksum is calculated using the following algorithm:

FUNCTION SimpleCheckSum values

SET dwChecksum to 0x0000

FOR each value in values

SET dwChecksum TO (dwChecksum XOR value)

RETURN dwChecksum

The width and height of legend in pixels are calculated with the following steps:

- Get **chart area** width in pixels as indicated by section [2.2.3.17](#) "Chart Area"
- Get chart area height in pixels as indicated by section [2.2.3.17](#) "Chart Area"
- Compute legend size in pixels

legend width in pixels = **dx** field of Legend / 4000 * chart area width in pixels

legend height in pixels = **dy** field of Legend / 4000 * chart area height in pixels

A - unused (1 bit): Undefined and MUST be ignored.

B - autolayouttype (4 bits): An unsigned integer that specifies the automatic layout type of the legend. MUST be ignored when this record is in the sequence of records that conforms to the ATTACHEDLABEL rule. MUST be a value from the following table:

Value	Meaning
0x0	Align to the bottom
0x1	Align to top right corner

Value	Meaning
0x2	Align to the top
0x3	Align to the right
0x4	Align to the left

reserved1 (11 bits): MUST be zero, and MUST be ignored.

wXMode (2 bytes): A [CrtLayout12Mode](#) structure that specifies the meaning of **x**.

wYMode (2 bytes): A [CrtLayout12Mode](#) structure that specifies the meaning of **y**.

wWidthMode (2 bytes): A [CrtLayout12Mode](#) structure that specifies the meaning of **dx**.

wHeightMode (2 bytes): A [CrtLayout12Mode](#) structure that specifies the meaning of **dy**.

x (8 bytes): An Xnum (section [2.5.342](#)) value that specifies a horizontal offset. The meaning is determined by **wXMode**.

y (8 bytes): An Xnum value that specifies a vertical offset. The meaning is determined by **wYMode**.

dx (8 bytes): An Xnum value that specifies a width or an horizontal offset. The meaning is determined by **wWidthMode**.

dy (8 bytes): An Xnum value that specifies a height or an vertical offset. The meaning is determined by **wHeightMode**.

reserved2 (2 bytes): MUST be zero, and MUST be ignored.

2.4.67 CrtLayout12A

The **CrtLayout12A** record specifies layout information for a **plot area**.

0	1	2	3	4	5	6	7	8	9	10	11	12	13	14	15	16	17	18	19	20	21	22	23	24	25	26	27	28	29	30	31
frtHeader																															
...																															
...																															
dwChecksum																															
A	reserved1															xTL															
yTL																xBR															
yBR																wXMode															
wYMode																wWidthMode															
wHeightMode																x															

...	
...	y
...	
...	dx
...	
...	dy
...	
...	reserved2

frtHeader (12 bytes): An [FrtHeader](#) structure. The **frtheader.rt** field MUST be 0x08A7.

dwChecksum (4 bytes): An unsigned integer that specifies the **checksum**. MUST be a value from the following table:

fManPlotArea field of ShtProps	fAlwaysAutoPlotArea field of ShtProps	dwChecksum
0x0	0x0	0x00000001
0x0	0x1	0x00000000
0x1	0x0	0x00000000
0x1	0x1	0x00000001

A - fLayoutTargetInner (1 bit): A bit that specifies the type of plot area for the layout target.

Value	Meaning
0x0	Outer plot area - The bounding rectangle that includes the axis labels, axis titles, data table (2) and plot area of the chart .
0x1	Inner plot area - The rectangle bounded by the chart axes.

reserved1 (15 bits): MUST be zero, and MUST be ignored.

xTL (2 bytes): A signed integer that specifies the horizontal offset of the plot area's upper-left corner, relative to the upper-left corner of the **chart area** (section [2.2.3.17](#)), in [SPRC](#).

yTL (2 bytes): A signed integer that specifies the vertical offset of the plot area's upper-left corner, relative to the upper-left corner of the chart area (section [2.2.3.17](#)), in [SPRC](#).

- xBR (2 bytes):** A signed integer that specifies the width of the plot area, in SPRC.
- yBR (2 bytes):** A signed integer that specifies the height of the plot area, in SPRC.
- wXMode (2 bytes):** A [CrtLayout12Mode](#) structure that specifies the meaning of **x**.
- wYMode (2 bytes):** A [CrtLayout12Mode](#) structure that specifies the meaning of **y**.
- wWidthMode (2 bytes):** A [CrtLayout12Mode](#) structure that specifies the meaning of **dx**.
- wHeightMode (2 bytes):** A [CrtLayout12Mode](#) structure that specifies the meaning of **dy**.
- x (8 bytes):** An Xnum (section [2.5.342](#)) value that specifies a horizontal offset. The meaning is determined by **wXMode**.
- y (8 bytes):** An Xnum value that specifies a vertical offset. The meaning is determined by **wYMode**.
- dx (8 bytes):** An Xnum value that specifies a width or a horizontal offset. The meaning is determined by **wWidthMode**.
- dy (8 bytes):** An Xnum value that specifies a height or a vertical offset. The meaning is determined by **wHeightMode**.
- reserved2 (2 bytes):** MUST be zero, and MUST be ignored.

2.4.68 CrtLine

The **CrtLine** record specifies the presence of **drop lines**, **high-low lines**, **series lines** or **leader lines** on the [chart group](#). This record is followed by a [LineFormat](#) record which specifies the format of the lines.

0	1	2	3	4	5	6	7	8	9	10	11	12	13	14	15	16	17	18	19	20	21	22	23	24	25	26	27	28	29	30	31
id																															

id (2 bytes): An unsigned integer that specifies the type of line that is present on the chart group. This field value MUST be unique among the other **id** field values in CrtLine records in the current chart group. This field MUST be greater than the **id** field values in preceding CrtLine records in the current chart group. MUST be a value from the following table:

Value	Type of Line
0x0000	Drop lines below the data points of line, area, and stock chart groups.
0x0001	High-low lines around the data points of line and stock chart groups.
0x0002	Series lines connecting data points of stacked column and bar chart groups, and the primary pie to the secondary bar/pie of bar of pie and pie of pie chart groups.
0x0003	Leader lines with non-default formatting connecting data labels to the data point of pie and pie of pie chart groups.

2.4.69 CrtLink

The **CrtLink** record is written but unused.

0	1	2	3	4	5	6	7	8	9	10	11	12	13	14	15	16	17	18	19	20	21	22	23	24	25	26	27	28	29	30	31
unused																															
...																															
...																															

unused (10 bytes): Undefined and MUST be ignored.

2.4.70 CrtMIFrt

The **CrtMIFrt** record specifies additional properties for [chart](#) elements, as specified by the [Chart Sheet Substream ABNF](#). These properties complement the record to which they correspond, and are stored as a structure chain defined in [XmlTkChain](#). An application can ignore this record without loss of functionality, except for the additional properties. If this record is longer than 8224 bytes, it MUST be split into several records. The first section of the data appears in this record and subsequent sections appear in one or more [CrtMIFrtContinue](#) records that follow this record.

0	1	2	3	4	5	6	7	8	9	10	11	12	13	14	15	16	17	18	19	20	21	22	23	24	25	26	27	28	29	30	31
frtHeader																															
...																															
...																															
cb																															
xmltkChain (variable)																															
...																															
unused																															

frtHeader (12 bytes): An [FrtHeader](#) structure. The **frtHeader.rt** field MUST be 0x089E.

cb (4 bytes): An unsigned integer that specifies the size, in bytes, of the XmlTkChain structure starting in the **xmltkChain** field, including the data contained in the optional CrtMIFrtContinue records. MUST be less than or equal to 0x7FFFFFFB.

xmltkChain (variable): An XmlTkChain structure that specifies a chain of structures. The size of the XmlTkChain is specified by the **cb** field.

unused (4 bytes): Undefined, and MUST be ignored.

2.4.71 CrtMIFrtContinue

The **CrtMIFrtContinue** record specifies additional data for a [CrtMIFrt](#) record, as specified in the CrtMIFrt record.

0	1	2	3	4	5	6	7	8	9	10	11	12	13	14	15	16	17	18	19	20	21	22	23	24	25	26	27	28	29	30	31
frtHeader																															
...																															
...																															
xmtkChain (variable)																															
...																															

frtHeader (12 bytes): An [FrtHeader](#) structure. The **frtHeader.rt** field MUST be 0x089F.

xmtkChain (variable): An array of bytes that contains the continuation of the **xmtkChain** field of the CrtMIFrt record associated with this record. If the length of this record is greater than 8224 bytes, additional CrtMIFrtContinue records follow.

2.4.72 CUsr

The **CUsr** record specifies the number of unique users that have this [shared workbook](#) open.

0	1	2	3	4	5	6	7	8	9	10	11	12	13	14	15	16	17	18	19	20	21	22	23	24	25	26	27	28	29	30	31
iCount																															

iCount (2 bytes): An unsigned integer that specifies the number of unique users that have this shared workbook open. MUST be greater than or equal to 0 and less than or equal to 255.

2.4.73 Dat

The **Dat** record specifies the beginning of a collection of records as defined by the [Chart Sheet Substream ABNF](#). The collection of records specifies the options of the [data table](#) which can be displayed within a **chart area** (section [2.2.3.17](#)).

0	1	2	3	4	5	6	7	8	9	10	11	12	13	14	15	16	17	18	19	20	21	22	23	24	25	26	27	28	29	30	31
A	B	C	D	reserved																											

A - fHasBordHorz (1 bit): A bit that specifies whether horizontal **cell borders** are displayed within the data table.

B - fHasBordVert (1 bit): A bit that specifies whether vertical cell borders are displayed within the data table.

C - fHasBordOutline (1 bit): A bit that specifies whether an outside **outline** is displayed around the data table.

D - fShowSeriesKey (1 bit): A bit that specifies whether the **legend key** is displayed next to the name of the [series](#). If the value is 1, the legend key symbols are displayed next to the name of the series.

reserved (12 bits): MUST be zero, and MUST be ignored.

2.4.74 DataFormat

The **DataFormat** record specifies the [data point](#) or [series](#) that the formatting information that follows applies to and specifies the beginning of a collection of records as defined by the [Chart Sheet Substream ABNF](#). This collection of records specifies formatting properties for the data point or series.

0	1	2	3	4	5	6	7	8	9	10	11	12	13	14	15	16	17	18	19	20	21	22	23	24	25	26	27	28	29	30	31	
xi																yi																
iss																A	reserved															

xi (2 bytes): An unsigned integer that specifies the zero-based index of the data point within the series specified by **yi**. If this value is 0xFFFF, the formatting information that follows applies to the series. Otherwise, the formatting information that follows applies to a data point. This value MUST be less than or equal to 31999. This value MUST be less than or equal to 3999 for a [chart](#) that contains a [Chart3d](#) record. This value MUST be 0xFFFF if the formatting information in this record is applied to a [trendline](#) or [error bar](#).

yi (2 bytes): An unsigned integer that specifies the zero-based index of a [Series](#) record in the collection of Series records in this chart sheet substream. SHOULD<75> be less than or equal to 254.

iss (2 bytes): An unsigned integer that specifies properties of the data series, trendline or error bar, depending on the type of records in sequence of records that conforms to the SERIESFORMAT rule that contains the sequence of records that conforms to the SS rule that contains this record.

- If the SERIESFORMAT rule does not contain a [SerAuxTrend](#) or [SerAuxErrBar](#) record, then this field specifies the plot order of the data series. If the series order was changed, this field can be different from **yi**. SHOULD<76> be less than or equal to the number of series in the chart. MUST be unique among **iss** values for all instances of this record contained in the SERIESFORMAT rule that does not contain a SerAuxTrend or SerAuxErrBar record.
- If the SERIESFORMAT rule contains a SerAuxTrend record on the [chart group](#), then this field specifies the trendline number for the series.
- If the SERIESFORMAT rule contains a SerAuxErrBar record on the chart group, then this field specifies a zero-based index into a Series record in the collection of Series records in the current chart sheet substream for which the error bar applies to.

A - fXL4iss (1 bit): MUST be zero, and MUST be ignored.

reserved (15 bits): MUST be zero, and MUST be ignored.

2.4.75 DataLabExt

The **DataLabExt** record specifies the beginning of a collection of records as defined by the [Chart Sheet Substream ABNF](#). The collection specifies an extended [data label](#).

0	1	2	3	4	5	6	7	8	9	10	11	12	13	14	15	16	17	18	19	20	21	22	23	24	25	26	27	28	29	30	31
frtHeader																															
...																															
...																															

frtHeader (12 bytes): An [FrtHeader](#) structure. The **frtHeader.rt** field MUST be 0x086A.

2.4.76 DataLabExtContents

The **DataLabExtContents** record specifies the contents of an extended [data label](#).

0	1	2	3	4	5	6	7	8	9	10	11	12	13	14	15	16	17	18	19	20	21	22	23	24	25	26	27	28	29	30	31
frtHeader																															
...																															
...																															
A	B	C	D	E	reserved													rgchSep (variable)													
...																															

frtHeader (12 bytes): An [FrtHeader](#) structure. The **frtHeader.rt** field MUST be 0x086B.

A - fSerName (1 bit): A bit that specifies whether the name of the [series](#) is displayed in the extended data label.

B - fCatName (1 bit): A bit that specifies whether the **category (2)** name, or the horizontal value on bubble or scatter [chart groups](#), is displayed in the extended data label. MUST be a value from the following table:

Value	Meaning
0	Neither of the data values are displayed in the extended data label.
1	If bubble or scatter chart group, the horizontal value is displayed in the extended data label. Otherwise, the category (2) name is displayed in the extended data label.

C - fValue (1 bit): A bit that specifies whether the data value, or the vertical value on bubble or scatter chart groups, is displayed in the extended data label. MUST be a value from the following table:

Value	Meaning
0	Neither of the data values are displayed in the data label.
1	If bubble or scatter chart group, the vertical value is displayed in the extended data label. Otherwise, the data value is displayed in the extended data label.

D - fPercent (1 bit): A bit that specifies whether the value of the corresponding [data point](#), represented as a percentage of the sum of the values of the series the data label is associated with, is displayed in the extended data label.

MUST equal 0 if the chart group type of the corresponding chart group, series, or data point is not a bar of pie, doughnut, pie, or pie of pie chart group.

E - fBubSizes (1 bit): A bit that specifies whether the **bubble size** is displayed in the data label.

MUST equal 0 if the chart group type of the corresponding chart group, series, or data point is not a bubble chart group.

reserved (11 bits): MUST be zero, and MUST be ignored.

rgchSep (variable): A case-sensitive [XLUnicodeStringMin2](#) structure that specifies the string that is inserted between every data value to form the extended data label. For example, if **fCatName** and **fValue** are set to 1, the labels will look like "*Category Name*<value of **rgchSep**>*Data Value*". The length of the string is contained in the **cch** field of the [XLUnicodeStringMin2](#) structure.

2.4.77 Date1904

The **Date1904** record specifies the **date system** that the **workbook** uses.

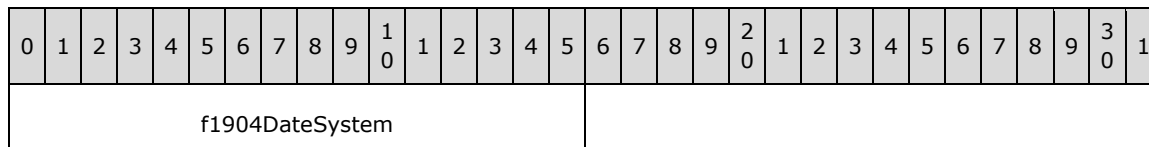

f1904DateSystem (2 bytes): A Boolean (section [2.5.14](#)) that specifies the date system used in this workbook. MUST be a value from the following table:

Value	Meaning
0x0000	The workbook uses the 1900 date system. The first date of the 1900 date system is 00:00:00 on January 1, 1900, specified by a serial value of 1.
0x0001	The workbook uses the 1904 date system. The first date of the 1904 date system is 00:00:00 on January 1, 1904, specified by a serial value of 0.

2.4.78 DBCell

The **DBCell** record specifies a row block, which is a series of up to 32 consecutive rows.

DBCell, combined with the [Index](#) record, is used to optimize the [lookup of cells](#) in a [cell table](#).

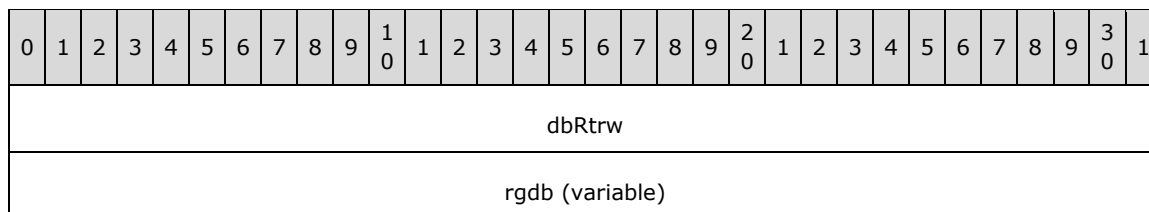

...

dbRtrw (4 bytes): An unsigned integer that specifies the offset in bytes from the starting file position of this record to the file position of the first [Row](#) record. If the value is 0, the referenced row block does not contain any rows that contain cells that have data.

rgdb (variable): An array of 2-byte unsigned integers that specify the file offset in bytes to the first record that specifies a [CELL](#) in each row that is a part of this row block. For the first array element, the starting position of the file offset is specified relative to the file position of the end of the first Row record in the row block. For all other elements, the file offset is specified relative to the file position of the CELL record specified by the previous element in this array. The number of elements in the array **MUST** be less than or equal to 32.

2.4.79 DbOrParamQry

The **DbOrParamQry** record specifies a [DbQuery](#) or [ParamQry](#) record depending on the record that precedes this record.

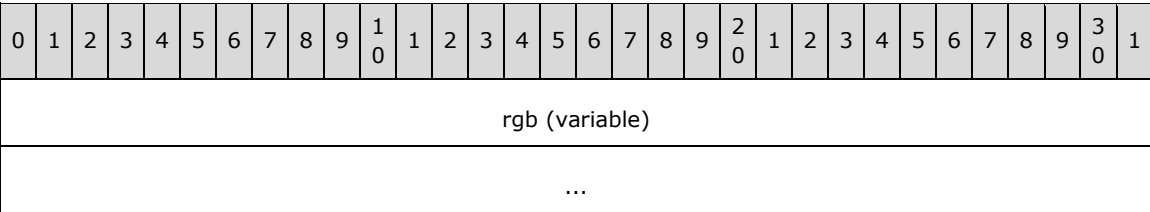

rgb (variable): A variable type field that specifies a DbQuery or ParamQry record depending on the record that precedes this record as specified by the following table:

Preceding Record	Record Type
SXString	ParamQry
DbOrParamQry of type ParamQry	ParamQry
Any other record	DbQuery

2.4.80 DbQuery

The **DbQuery** record specifies information about an [external connection](#). This record is followed by [SXString](#) and [ParamQry](#) records that specify the strings and parameters. The records **MUST** be in the following order:

- If and only if **fSql** equals 1, zero or more SXString records as specified by **cstQuery**.
- If and only if **fOdbcConn** equals 1, zero or more SXString records as specified by **cstOdbcConn**.
- If and only if **fWeb** equals 1, zero or more SXString records as specified by **cstQuery**.
- If and only if **fWeb** equals 1, zero or more SXString records as specified by **cstWebPost**.
- Zero or more SXString and ParamQry pairs as specified by **cparams**.
- If and only if **fSqlSav** equals 1, zero or more SXString records as specified by **cstSQLSav**.

0	1	2	3	4	5	6	7	8	9	10	11	12	13	14	15	16	17	18	19	20	21	22	23	24	25	26	27	28	29	30	31
dbt			A	B	C	D	E	F	unused							cparams															
cstQuery															cstWebPost																
cstSQLSav															cstOdbcConn																

dbt (3 bits): An unsigned integer that specifies the **data source** type. MUST be a value from the following table:

Value	Meaning
0x1	ODBC data source
0x2	DAO record set
0x4	Web query
0x5	OLE DB database
0x6	Text query
0x7	ADO query

A - fOdbcConn (1 bit): A bit that specifies whether the data source type is **ODBC**. MUST be 1 if **dbt** is equal to 0x1.

B - fSql (1 bit): A bit that specifies whether there is a database command string. MUST be 0 if **fWeb** is 1. If the value of **dbt** is 5 see the **grbitDbt** field of the [DBQueryExt](#) record for details on what the database command string specifies. Otherwise the database command string specifies an **Structured Query Language (SQL) query** string. The database command string is contained by zero or more SXString records following this record, as specified by **cstQuery**.

C - fSqlSav (1 bit): A bit that specifies whether there is a SQL query string for server-based fields. For more information about server-based fields see the [source data](#) section. If and only if **fSqlSav** equals 1, the SQL query string for server-based fields is contained by zero or more SXString records following this record, as specified by **cstSQLSav**.

D - fWeb (1 bit): A bit that specifies whether there is a **Uniform Resource Locator (URL)** for a **Web query**. MUST be 1 if **dbt** is equal to 0x4. The URL is the command string contained in zero or more SXString records following this record, as specified by **cstQuery**.

E - fSavePwd (1 bit): A bit that specifies whether the password is saved with the ODBC **connection string** specified by SXString records following this record. MUST be a value from the following table:

Value	Meaning
0	Password is removed from the ODBC connection string.
1	Password is not removed from the ODBC connection string.

MUST be ignored if **dbt** is not equal to 0x1.

F - fTablesOnlyHTML (1 bit): A bit that specifies whether Web queries only works on HTML tables.

unused (7 bits): Undefined and MUST be ignored.

cparams (2 bytes): A signed integer that specifies the number of SQL parameters. Each parameter consists of an SXString record followed by a ParamQry record. The SXString record specifies the name of the parameter and the ParamQry record specifies the query parameters. MUST be greater than or equal to zero.

cstQuery (2 bytes): A signed integer that specifies the number of SXString records that contain the command string, see **fWeb** and **fSql** for more details. Each SXString record specifies up to 255 characters of the complete command string. MUST be greater than or equal to zero.

cstWebPost (2 bytes): A signed integer that specifies the number of SXString records that contain the Web query statement. Each SXString record specifies up to 255 characters of the complete query statement. MUST be greater than or equal to zero. MUST be 0 if **fWeb** is equal to 0.

cstSQLSav (2 bytes): A signed integer that specifies the number of SXString records that contain the SQL statement for server-based fields. For more information about server-based fields see the source data section. Each SXString record specifies up to 255 characters of the complete SQL statement. MUST be greater than or equal to zero. MUST be 0 if **fSqlSav** is equal to 0.

cstOdbcConn (2 bytes): A signed integer that specifies the number of SXString records that contain the ODBC connection string. Each SXString record specifies up to 255 characters of the complete connection string. MUST be greater than or equal to zero. MUST be 0 if **fOdbcConn** is equal to 0.

2.4.81 DBQueryExt

The **DBQueryExt** record specifies information about an [external connection](#). This record specifies the beginning of a collection of records as specified by the [Worksheet Substream ABNF](#). The collection specifies more information about the external connection. See the [QsiSXTag](#) record for details about how the **query table** or [PivotCache](#) for the external connection is determined. The records of the collection MUST be in the following order:

- The first record MUST be an [ExtString](#) record that specifies the comma-delimited list of **table** names to import, if and only if **fTableNames** is equal to 1.
- The next record MUST be a [TxtQry](#) record, if and only if **fTxtWiz** is equal to 1.
- The next record or records MUST be zero or more [OleDbConn](#) records as specified by **coledb**.

0	1	2	3	4	5	6	7	8	9	10	11	12	13	14	15	16	17	18	19	20	21	22	23	24	25	26	27	28	29	30	31	
firtHeaderOld																																
dbt																A	B	C	D	E	F	G	reserved1									
grbitDbt (variable)																																
...																																
H	I	J	reserved3														bVerDbqueryEdit					bVerDbqueryRefreshed										
bVerDbqueryRefreshable										reserved4										reserved5												
coledb																cstFuture																
wRefreshInterval																wHtmlFmt																

cwParamFlags	rgPbt (variable)
...	
rgbFutureBytes (variable)	
...	

frtHeaderOld (4 bytes): An [FrtHeaderOld](#) structure. The **frtHeaderOld.rt** field MUST be 0x0803.

dbt (2 bytes): A [DataSourceType](#) enumeration that specifies the database source.

A - fMaintain (1 bit): A bit that specifies whether the connection with the database remains open once established.

B - fNewQuery (1 bit): A bit that specifies whether the connection was not refreshed. MUST be a value from the following table:

Value	Meaning
0	Connection was refreshed one or more times
1	Connection was not refreshed

C - fImportXmlSource (1 bit): A bit that specifies whether the underlying **XML** source or the Web page table is imported. MUST be ignored if **dbt** is not equal to 0x0004. MUST be a value from the following table:

Value	Meaning
0	Web page table is imported
1	XML source is imported

D - fSPListSrc (1 bit): A bit that specifies if the external connection is using the Web based **data provider**.

E - fSPListReinitCache (1 bit): A bit that specifies whether the Web based data is reinitialized rather than refreshed. MUST be ignored if **fSPListSrc** is equal to 0. MUST be a value from the following table:

Value	Meaning
0	Web based data is refreshed.
1	Web based data is reinitialized by reconnecting to the Web based data provider.

F - unused (2 bits): Undefined and MUST be ignored.

G - fSrcIsXml (1 bit): A bit that specifies whether the external connection source is XML.

reserved1 (8 bits): MUST be zero, and MUST be ignored.

grbitDbt (variable): A [ConnGrbitDbt](#) structure that specifies external connection properties specific to **dbt**.

H - fTxtWiz (1 bit): A bit that specifies whether this is a **text query**. If the value is equal to 1, this record MUST be followed by a TxtQry record.

I - fTableNames (1 bit): A bit that specifies whether the tables to import are specified in the ExtString record that follows this record.

J - reserved2 (1 bit): MUST be zero, and MUST be ignored.

reserved3 (13 bits): MUST be zero, and MUST be ignored.

bVerDbqueryEdit (1 byte): A [DataFunctionalityLevel](#) value that specifies the [data functionality level](#) the external connection was last edited with.

bVerDbqueryRefreshed (1 byte): A DataFunctionalityLevel value that specifies the data functionality level the external connection was last refreshed with. MUST be ignored if **fNewQuery** is equal to 1.

bVerDbqueryRefreshableMin (1 byte): A DataFunctionalityLevel value that specifies the minimum data functionality level that the application is required to support refreshing the external connection. MUST be ignored if **fNewQuery** is equal to 1.

reserved4 (1 byte): MUST be zero, and MUST be ignored.

reserved5 (2 bytes): MUST be zero, and MUST be ignored.

coledb (2 bytes): An unsigned integer that specifies the count of OleDbConn records that follow this record. MUST be zero if **dbt** is not equal to DBT_OLEDB.

cstFuture (2 bytes): An unsigned integer that specifies the count of bytes in **rgbFutureBytes**.

wRefreshInterval (2 bytes): An unsigned integer that specifies the number of minutes to wait between automatic refreshes of the external connection. The value MUST be greater than or equal to 0. A value of 0 specifies that the timed **refresh** is off.

wHtmlFmt (2 bytes): An unsigned integer that specifies the HTML formatting to apply to the imported data for a **Web query**. MUST be ignored if **dbt** is not equal to 0x0004. MUST be a value from the following table:

Value	Meaning
0x0001	No formatting is applied
0x0002	Rich text formatting only
0x0003	Full HTML formatting, including cell formatting

cwParamFlags (2 bytes): An unsigned integer that specifies the count of [PBT](#) items in **rgPbt**.

rgPbt (variable): An array of PBT items, each of which specifies information about the **query** parameters. The PBT items in the array specify information about same query parameters as the collection of [ParamQry](#) records of the external connection. The nth PBT item in this array corresponds to the nth ParamQry record within the collection.

rgbFutureBytes (variable): Information from future versions. The byte count MUST be equal to **cstFuture**.

2.4.82 DCon

The **DCon** record specifies the **data consolidation** settings of the associated **sheet** and specifies the beginning of a collection of records as defined by the [Macro Sheet Substream ABNF](#) and [Worksheet](#)

[Substream](#) ABNF. The collection of records specifies the **source data ranges**. Data consolidation settings can exist in a sheet that does not have a data consolidation range.

0	1	2	3	4	5	6	7	8	9	10	11	12	13	14	15	16	17	18	19	20	21	22	23	24	25	26	27	28	29	30	31
iifTab																fLeftCat															
fTopCat																fLinkConsole															

iifTab (2 bytes): An unsigned integer that specifies the **function** used to aggregate the source data. MUST be a value from the following table:

Value	Function Name	Meaning
0x0000	Average	The average (arithmetic mean).
0x0001	Count Numbers	The count of the numeric values.
0x0002	Count	The count of data values.
0x0003	Maximum	The largest value.
0x0004	Minimum	The smallest value.
0x0005	Product	The product of the values.
0x0006	Standard Deviation	An estimate of the standard deviation of a population, where the sample is a subset of the entire population.
0x0007	Standard Deviation Population	The standard deviation based on the entire population.
0x0008	Sum	The summation of the numeric values.
0x0009	Variance	An estimate of the variance of a population, where the sample is a subset of the entire population.
0x000A	Variance Population	The variance of a population, where the population is all of the data to be summarized.

fLeftCat (2 bytes): A Boolean (section [2.5.14](#)) that specifies how to identify rows for data consolidation. MUST be a value from the following table:

Value	Meaning
0x0000	Data consolidation is based on the position of the row in the source data ranges.
0x0001	Data consolidation is based on row labels from the leftmost column of the source data ranges. String comparison is case independent and the consolidated data contains a row for each unique row label. The unique row labels appear in the first column in the consolidation range , if it exists.

fTopCat (2 bytes): A Boolean that specifies how to identify columns for data consolidation. MUST be a value from the following table:

Value	Meaning
0x0000	Data consolidation is based on the position of the column in the source data ranges.

Value	Meaning
0x0001	Data consolidation is based on column labels from the top row of the source data ranges. String comparison is case independent and the consolidated data contains a column for each unique column label. The unique column labels appear in the top row of the consolidation range, if it exists.

fLinkConsole (2 bytes): A Boolean that specifies whether data consolidation will create references to the source data. MUST be a value from the following table:

Value	Meaning
0x0000	References are not created to the source data.
0x0001	References are created to the source data.

2.4.83 DConBin

The **DConBin** record specifies a built-in **named range** that is a **data source** for a [PivotTable](#) or a data source for the **data consolidation** settings of the associated **sheet**.

0	1	2	3	4	5	6	7	8	9	10	11	12	13	14	15	16	17	18	19	20	21	22	23	24	25	26	27	28	29	30	31
nBuiltin										reserved1										reserved2											
cchFile																stFile (variable)															
...																															
unused (variable)																															
...																															

nBuiltin (1 byte): An unsigned integer that specifies the built-in **defined name** for the **range**. MUST be a value from the following table:

Value	Meaning
0x00	"Consolidate_Area"
0x01	"Auto_Open"
0x02	"Auto_Close"
0x03	"Extract"

Value	Meaning
0x04	"Database"
0x05	"Criteria"
0x06	"Print_Area"
0x07	"Print_Titles"
0x08	"Recorder"
0x09	"Data_Form"
0x0A	"Auto_Activate"
0x0B	"Auto_Deactivate"
0x0C	"Sheet_Title"
0x0D	"_FilterDatabase"

reserved1 (2 bytes): MUST be zero and MUST be ignored.

reserved2 (1 byte): MUST be zero and MUST be ignored.

cchFile (2 bytes): An unsigned integer that specifies the character count of **stFile**. MUST be 0x0000, or greater than or equal to 0x0002. A value of 0x0000 specifies that the built-in defined name specified in **nBuiltin** has a **workbook** scope and is contained in this file.

stFile (variable): An [DConFile](#) structure that specifies the workbook or workbook and sheet that contains the range specified in **nBuiltin**. This field MUST exist if and only if the value of **cchFile** is greater than zero. If the built-in defined name has workbook scope this field specifies the workbook file that contains the built-in defined name and its associated range. If the built-in defined name has a sheet-level scope this field specifies both the sheet name and the workbook file that contains the built-in defined name and its associated range.

unused (variable): An array of bytes that is unused and MUST be ignored. MUST exist if and only if **cchFile** is greater than 0 and **stFile** specifies a self-reference (the value of **stFile.stFile.rgb[0]** is 2). If the value **stFile.stFile.fHighByte** is 0 the size of this array is 1. If the value of **stFile.stFile.fHighByte** is 1 the size of this array is 2.

2.4.84 DConn

The **DConn** record specifies information for a single data connection.

0	1	2	3	4	5	6	7	8	9	10	11	12	13	14	15	16	17	18	19	20	21	22	23	24	25	26	27	28	29	30	31
frtHeaderOld																															
dbt																A	B	C	D	E	F	G	H	I	unused1						
cParams																reserved1															
J	K	L	M	N	O	P	reserved2					grbitDbt (variable)																			
...																															
bVerDbqueryEdit								bVerDbqueryRefreshed								bVerDbqueryRefreshable								wRefreshInterval							
...								wHtmlFmt																rcc							
...																credMethod															
reserved3								rgchSourceDataFile (variable)																							
...																															
rgchSourceConnectionFile (variable)																															
...																															
rgchConnectionName (variable)																															
...																															
rgchConnectionDesc (variable)																															
...																															
rgchSSOApplicationID (variable)																															
...																															
tableNames (variable)																															
...																															
params (variable)																															
...																															
connection (variable)																															
...																															

rgbSQL (variable)
...
rgbSQLSav (variable)
...
rgbEditWebPage (variable)
...
id (variable)
...

frtHeaderOld (4 bytes): An [FrtHeaderOld](#). The **frtHeaderOld.rt** field MUST be 0x0876.

dbt (2 bytes): A [DataSourceType](#) that specifies the type of this data connection.

A - fSavePwd (1 bit): A bit that specifies whether a password is saved for this data connection. This field MUST be ignored if **dbt** is not equal to 0x0001 or 0x0005.

B - fTablesOnlyHtml (1 bit): A bit that specifies whether web queries retrieve data from HTML tables only. MUST be ignored if **dbt** is not equal to 0x0004. MUST be a value from the following table:

Value	Meaning
0x0	Web queries retrieve data from the entire page.
0x1	Web queries retrieve data from HTML tables only.

C - fTableNames (1 bit): A bit that specifies whether there are any HTML tables saved for this data connection. MUST be ignored if **dbt** is not equal to 0x0004. Value MUST equal 1 if **fTablesOnlyHtml** is equal to 1.

D - fDeleted (1 bit): A bit that specifies whether the data connection associated with the **workbook** has been deleted.

E - fStandAlone (1 bit): A bit that specifies whether the data connection is used by the workbook.

F - fAlwaysUseConnectionFile (1 bit): A bit that specifies whether the data connection information in the connection file is used when the data is refreshed. This field MUST be ignored if **dbt** is not equal to 0x0001 or 0x0005.

G - fBackgroundQuery (1 bit): A bit that specifies whether the data connection is refreshed asynchronously.

H - fRefreshOnLoad (1 bit): A bit that specifies whether the data connection is refreshed after the file is loaded.

I - fSaveData (1 bit): A bit that specifies if the data for the data connection is persisted in the workbook.

unused1 (7 bits): Undefined and MUST be ignored.

cParams (2 bytes): An unsigned integer that specifies the number of parameters for a **parameterized query**. The value MUST equal 0 if **fStandAlone** equals 0.

reserved1 (2 bytes): MUST be zero and MUST be ignored.

J - fMaintain (1 bit): A bit that specifies whether the data connection remains open once it is established.

K - fNewQuery (1 bit): A bit that specifies whether the data connection has been refreshed. MUST be a value from the following table:

Value	Meaning
0	Connection has been refreshed one or more times
1	Connection has not yet been refreshed

L - fImportXmlSource (1 bit): A bit that specifies whether the underlying **XML** source or the Web page table has been imported. MUST be ignored if **dbt** is not equal to 0x0004. MUST be a value from the following table:

Value	Meaning
0	Web page table has been imported
1	XML source has been imported

M - fSPListSrc (1 bit): A bit that specifies whether the query is using a Web-based **data provider**. MUST be ignored if **dbt** is not equal to 0x0005.

N - fSPListReinitCache (1 bit): A bit that specifies whether the Web based data is reinitialized rather than refreshed. MUST be ignored if **dbt** is not equal to 0x0005. MUST be a value from the following table:

Value	Meaning
0	List is refreshed
1	List is reinitialized by reconnecting to the data provider

O - unused2 (2 bits): Undefined and MUST be ignored.

P - fSrcIsXml (1 bit): A bit that specifies whether the query source is XML. MUST be ignored if **dbt** is not equal to 0x0004.

reserved2 (8 bits): MUST be zero and MUST be ignored.

grbitDbt (variable): A [ConnGrbitDbt](#) that specifies the query flags.

bVerDbqueryEdit (1 byte): A [DataFunctionalityLevel](#) that specifies the [data functionality level](#) the **query** was last edited with.

bVerDbqueryRefreshed (1 byte): A [DataFunctionalityLevel](#) that specifies the data functionality level the query was last refreshed with.

bVerDbqueryRefreshableMin (1 byte): A [DataFunctionalityLevel](#) that specifies the minimum data functionality level that the application is required to support to **refresh** the query.

wRefreshInterval (2 bytes): An unsigned integer that specifies the number of minutes to wait between automatic refreshes of the query. The value MUST be greater than or equal 0.

wHtmlFmt (2 bytes): An unsigned integer that specifies the HTML formatting to apply to the imported data for a **Web query**. MUST be ignored if **dbt** is not equal to 0x0004. MUST be a value from the following table:

Value	Meaning
0x0001	None
0x0002	Rich text formatting only
0x0003	Full HTML formatting

rcc (4 bytes): An unsigned integer that specifies the reconnection method. MUST be a value from the following table:

Value	Meaning
0x00000000	Reconnection method is determined by the application.
0x00000001	Reconnect. When the data connection is refreshed, the updated connection information is retrieved if it is available. This information is used instead of the persisted connection information.
0x00000002	Never reconnect. Updated connection information is never used even if the information is available and the existing connection information is invalid.

credMethod (1 byte): An unsigned integer that specifies the credentials used during reconnection. MUST be a value from the following table:

Value	Meaning
0x00	Integrated authentication
0x01	Use no credentials
0x02	Use stored credentials
0x03	Prompt for credentials

reserved3 (1 byte): MUST be zero and MUST be ignored.

rgchSourceDataFile (variable): A [DConnUnicodeStringSegmented](#) that specifies the database file to use if the existing **OLE DB** connection fails. MUST be ignored if **dbt** does not equal 0x0005.

rgchSourceConnectionFile (variable): A [DConnUnicodeStringSegmented](#) that specifies the **Office data connection (ODC) file** to use if the existing connection fails.

rgchConnectionName (variable): A [DConnUnicodeStringSegmented](#) that specifies the name of the data connection associated with the workbook.

rgchConnectionDesc (variable): A [DConnUnicodeStringSegmented](#) that specifies the description of the data connection associated with the workbook.

rgchSSOApplicationID (variable): A [DConnUnicodeStringSegmented](#) that specifies the **single sign-on (SSO) identifier** string. MUST be ignored if **dbt** does not equal 0x0001 or 0x0005.

tableNames (variable): A [DConnUnicodeStringSegmented](#) that specifies the list of **table** names as a comma-separated list. This field only exists when **fTableNames** is equal to 1. The total number of characters MUST be less than or equal to 255.

params (variable): An array of [DConnParameter](#) that specifies the parameters of a parameterized query. The size of the array is determined by **cParams**. MUST NOT exist if **fStandAlone** is equal to 0.

connection (variable): A variable type field. The data type and meaning vary depending on the value of **dbt**.

Value of dbt	Meaning
1	connection is a DConnUnicodeStringSegmented that specifies the connection string . If field fStandAlone is 0, then connection.st.cch MUST be 0.
4	connection is a DConnConnectionWeb that specifies the connection information for a Web query.
5	connection is a DConnConnectionOleDb that specifies the connection information for an OLE DB connection string.
6	connection is a TxtQry that specifies information for a text query .
Any other value	connection does not exist.

rgbSQL (variable): A [DConnStringSequence](#) that specifies the database command. For an OLE DB **data source**, the meaning of the **dbost** field of [ConnGrbitDbtOledb](#) determines the meaning of this field. For an **ODBC** data source, this string specifies the **SQL** statement. MUST be ignored if **dbt** does not equal 0x0001 or 0x0005.

rgbSQLSav (variable): A [DConnStringSequence](#) that specifies the original, non-parameterized SQL statement for an ODBC data source. MUST be ignored if **dbt** does not equal 0x0001.

rgbEditWebPage (variable): A [DConnStringSequence](#) that specifies the **URL** for the Web query edit query dialog. MUST be ignored if **dbt** does not equal 0x0004.

id (variable): A [DConnId](#) that specifies the object that this connection is associated with.

2.4.85 DConName

The **DConName** record specifies a **named range** that is a **data source** for a [PivotTable](#) or a data source for the **data consolidation** settings of the associated **sheet**. The **range** is specified as a reference to an [external workbook](#) or a **defined name** in this **workbook**. If the named range is in an external workbook, this record specifies the path to the external workbook. If the named range has a defined name that has a sheet-level scope, this record also specifies the name of the sheet that contains the range.

0	1	2	3	4	5	6	7	8	9	10	11	12	13	14	15	16	17	18	19	20	21	22	23	24	25	26	27	28	29	30	31
stName (variable)																															
...																															
cchFile																stFile (variable)															
...																															
unused (variable)																															

...

stName (variable): An [XLNameUnicodeString](#) structure that specifies a defined name for the source range.

cchFile (2 bytes): An unsigned integer that specifies the character count of **stFile**. MUST be 0x0000, or greater than or equal to 0x0002. A value of 0x0000 specifies that the defined name in **stName** has a workbook scope and is contained in this file.

stFile (variable): A [DConFile](#) structure that specifies the workbook, or workbook and sheet, that contains the range specified in **stName**. This field exists only if the value of **cchFile** is greater than zero. If the defined name in **stName** has workbook scope, this field specifies the workbook file that contains the defined name and its associated range. If the defined name in **stName** has a sheet-level scope, this field specifies both the sheet name and the workbook that contains the defined name and its associated range.

unused (variable): An array of bytes that is unused and MUST be ignored. MUST exist if and only if **cchFile** is greater than 0 and **stFile** specifies a self-reference (the value of **stFile.stFile.rgb[0]** is 2). If the value **stFile.stFile.fHighByte** is 0, the size of this array is 1. If the value of **stFile.stFile.fHighByte** is 1, the size of this array is 2.

2.4.86 DConRef

The **DConRef** record specifies a **range** in this **workbook** or in an [external workbook](#) that is a **data source** for a [PivotTable](#) or a data source for the **data consolidation** settings of the associated **sheet**. If the range specified is in an external workbook this record also specifies the path to the external workbook.

0	1	2	3	4	5	6	7	8	9	10	1	2	3	4	5	6	7	8	9	20	1	2	3	4	5	6	7	8	9	30	1		
ref																																	
...																	cchFile																
stFile (variable)																																	
...																																	
unused (variable)																																	
...																																	

ref (6 bytes): A [RefU](#) structure that specifies the range. If this record is part of an [SXTBL](#) production as specified in the Globals Substream **ABNF** and this field has a **rwFirst** equal to 0 and a **rwLast** equal to 16383, this reference specifies all rows within the columns specified by **colFirst** and **colLast**.

cchFile (2 bytes): An unsigned integer that specifies the count of characters in **stFile**. MUST be greater than or equal to 0x0002.

stFile (variable): A [DConFile](#) structure that specifies the workbook and sheet that contains the range specified in the **ref** field.

unused (variable): An array of bytes that is unused and MUST be ignored. MUST exist if and only if **stFile** specifies a self reference (the value of **stFile.stFile.rgb[0]** is 2). If the value **stFile.stFile.fHighByte** is 0 the size of this array is 1. If the value of **stFile.stFile.fHighByte** is 1 the size of this array is 2.

2.4.87 DefaultRowHeight

The **DefaultRowHeight** record specifies the height of all empty rows in the current **sheet**. An empty row is a row that only contains **cells** without data or formatting.

0	1	2	3	4	5	6	7	8	9	10	11	12	13	14	15	16	17	18	19	20	1	2	3	4	5	6	7	8	9	30	1
A	B	C	D	reserved												miyRw (optional)															
miyRwHidden (optional)																															

A - fUnsyncd (1 bit): A bit that specifies whether the default settings for the row height have been changed.

B - fDyZero (1 bit): A bit that specifies whether empty rows have a height of zero.

C - fExAsc (1 bit): A bit that specifies whether all empty rows have a thick **border style** applied to the top **border** (as specified in field **fExAsc** of record [Row](#)).

D - fExDsc (1 bit): A bit that specifies whether all empty rows have a thick border style applied to the bottom border (as specified in field **fExDes** of record [Row](#)).

reserved (12 bits): MUST be zero, and MUST be ignored.

miyRw (2 bytes): A signed integer that specifies the default row height, in **twips**, for empty rows. MUST exist if and only if **fDyZero** is 0. MUST be greater than or equal to 1 and less than or equal to 8179.

miyRwHidden (2 bytes): A signed integer that specifies the default row height, in twips, to apply to a **hidden** row when unhidden. MUST exist if and only if **fDyZero** is 1. MUST be greater than or equal to 0 and less than or equal to 8179.

2.4.88 DefaultText

The **DefaultText** record specifies the text elements that are formatted using the information specified by the [Text](#) record immediately following this record.

0	1	2	3	4	5	6	7	8	9	10	11	12	13	14	15	16	17	18	19	20	1	2	3	4	5	6	7	8	9	30	1
id																															

id (2 bytes): An unsigned integer that specifies the text elements that are formatted using the position and appearance information specified by the [Text](#) record immediately following this record. MUST be a value from the following table.

If this record is in a sequence of records that conforms to the [CRT](#) rule as specified by the Chart Sheet Substream **ABNF**, then this field MUST be 0x0000 or 0x0001. If this record is not in a sequence of records that conforms to the CRT rule as specified by the Chart Sheet Substream **ABNF**, then this field MUST be 0x0002 or 0x0003.

Value	Meaning
0x0000	Format all Text records in the chart_group where fShowPercent is equal to 0 or fShowValue is equal to 0.
0x0001	Format all Text records in the chart group where fShowPercent is equal to 1 or fShowValue is equal to 1.
0x0002	Format all Text records in the chart where the value of fScaled of the associated FontInfo structure is equal to 0.
0x0003	Format all Text records in the chart where the value of fScaled of the associated FontInfo structure is equal to 1.

2.4.89 DefColWidth

The **DefColWidth** record specifies the default column width of a **sheet** and specifies the beginning of a collection of [ColInfo](#) records as defined by the [Macro Sheet Substream ABNF](#) and [Worksheet Substream ABNF](#). The collection of ColInfo records specifies the column formatting for a **range** of columns.

0	1	2	3	4	5	6	7	8	9	10	11	12	13	14	15	16	17	18	19	20	21	22	23	24	25	26	27	28	29	30	31
cchdefColWidth																															

cchdefColWidth (2 bytes): An unsigned integer that specifies the default width, in number of characters, of the columns in the sheet. MUST be less than or equal to 255.

2.4.90 Dimensions

The **Dimensions** record specifies the used **range** of the **sheet**. It specifies the row and column bounds of used **cells** in the sheet. Used cells include all cells with formulas (section [2.2.2](#)) or data. Used cells also include all cells with formatting applied directly to the cell. Cells can also be formatted by default row or column formatting. If a row has default formatting then the used range includes that row in its row bounds, but does not affect the used range column bounds, unless the used range would otherwise be empty, in which case the column bounds are set to include the first column. If a column has default formatting then the used range includes that column in its column bounds, but does not affect the used range row bounds, unless the used range would otherwise be empty, in which case the row bounds are set to include the first row.

0	1	2	3	4	5	6	7	8	9	10	11	12	13	14	15	16	17	18	19	20	21	22	23	24	25	26	27	28	29	30	31
rwMic																															
rwMac																															
colMic																	colMac														
reserved																															

rwMic (4 bytes): A [RwLongU](#) structure that specifies the first row in the sheet that contains a used cell.

rwMac (4 bytes): An unsigned integer that specifies the zero-based index of the row after the last row in the sheet that contains a used cell. MUST be less than or equal to 0x00010000. If this value is 0x00000000, no cells on the sheet are used cells.

colMic (2 bytes): A [ColU](#) structure that specifies the first column in the sheet that contains a used cell.

colMac (2 bytes): An unsigned integer that specifies the zero-based index of the column after the last column in the sheet that contains a used cell. MUST be less than or equal to 0x0100. If this value is 0x0000, no cells on the sheet are used cells.

reserved (2 bytes): MUST be zero, and MUST be ignored.

2.4.91 DocRoute

The **DocRoute** record specifies the document routing information for a **routing slip<77>** that is used to send a document in an e-mail message and specifies the beginning of a collection of [RecipName](#) records as defined by the [Globals Substream ABNF](#). The collection of RecipName records specifies the recipients of the routing slip.

0	1	2	3	4	5	6	7	8	9	10	11	12	13	14	15	16	17	18	19	20	21	22	23	24	25	26	27	28	29	30	31
iStage										cRecip																					
delOption										A	B	C	D	E	F	unused2															
cchSubject										cchMessage																					
cchRouteID										cchCustType																					
cchBookTitle										cchOrg																					
ulEIDSize																															
szSubject (variable)																															
...																															
szMessage (variable)																															
...																															
szRouteID (variable)																															
...																															
szCustType (variable)																															
...																															
szBookTitle (variable)																															

...
szOrg (variable)
...
rgchSSAddr (variable)
...

iStage (2 bytes): An unsigned integer that specifies the **routing stage** of the slip. This value MUST be less than or equal to the **cRecip** field +1.

cRecip (2 bytes): An unsigned integer that specifies the number of recipients. MUST equal the actual number of RecipName records that follow this record.

delOption (2 bytes): An unsigned integer that specifies the delivery option. MUST be a value from the following table:

Value	Meaning
0x00	Deliver to one recipient at a time
0x01	Deliver to all recipients at once

A - fRouted (1 bit): A bit that specifies whether the document has been routed.

B - fReturnOrig (1 bit): A bit that specifies whether the document is returned to the originator after being routed to the last recipient.

C - fTrackStatus (1 bit): A bit that specifies whether a status message is sent to the originator after the document is routed.

D - fCustomType (1 bit): A bit that specifies whether there is a custom message type defined by **szCustType**.

E - unused1 (3 bits): Undefined and MUST be ignored.

F - fSaveRouteInfo (1 bit): A bit that specifies whether the routing information is saved with the document. MUST equal 1.

unused2 (8 bits): Undefined and MUST be ignored.

cchSubject (2 bytes): An unsigned integer that specifies the count of characters in the **szSubject** field string. MUST be less than or equal to 256.

cchMessage (2 bytes): An unsigned integer that specifies the count of characters in the **szMessage** field string. MUST be less than or equal to 256.

cchRouteID (2 bytes): An unsigned integer that specifies the count of characters in the **szRouteID** field string. MUST be less than or equal to 256.

cchCustType (2 bytes): An unsigned integer that specifies the count of characters in the **szCustType** field string. MUST be less than or equal to 256. MUST equal 0 if the **fCustomType** field equals 0.

cchBookTitle (2 bytes): An unsigned integer that specifies the count of characters in the **szBookTitle** field string. MUST be less than or equal to 256.

cchOrg (2 bytes): An unsigned integer that specifies the count of characters in the **szOrg** field string. MUST be less than or equal to 256.

ulEIDSize (4 bytes): An unsigned integer that specifies the count of characters in the **rgchSSAddr** field string. When combined with the values of **cchSubject**, **cchMessage**, **cchRouteID**, **cchCustType**, **cchBookTitle**, and **cchOrg** fields, the value MUST be less than or equal to 8202.

szSubject (variable): A NULL terminated array of ANSI characters that specifies the subject of the routed document. The length of the string MUST be specified by the **cchSubject** field. The field MUST NOT exist if the **cchSubject** field is 0.

szMessage (variable): A NULL terminated array of ANSI characters that specifies the message of the routed document. The length of the string MUST be specified by the **cchMessage** field. The field MUST NOT exist if the **cchMessage** field is 0.

szRouteID (variable): A NULL terminated array of ANSI characters that specifies the name of the routing identifier. The length of the string MUST be specified by the **cchRouteID** field. The field MUST NOT exist if the **cchRouteID** field is 0.

szCustType (variable): A NULL terminated array of ANSI characters that specifies a custom message. The length of the string MUST be specified by the **cchCustType** field. The field MUST NOT exist if the field **cchCustType** is 0.

For more information about the MapiMessage structure, see [\[MSDN-MapiMessage\]](#).

szBookTitle (variable): A NULL terminated array of ANSI characters that specifies the **workbook** title. The length of the string MUST be specified by the **cchBookTitle** field. The field MUST NOT exist if the **cchBookTitle** field is 0.

szOrg (variable): A NULL terminated array of ANSI characters that specifies the originator's **friendly name**. The length of the string MUST be specified by the **cchOrg** field. The field MUST NOT exist if the **cchOrg** field is 0.

rgchSSAddr (variable): A NULL terminated array of ANSI characters that specifies the identifier used by the **messaging system service provider** to identify the originator's e-mail address. The length of the string MUST be specified by the **ulEIDSize** field. The field MUST NOT exist if the **ulEIDSize** field is 0.

2.4.92 DropBar

The **DropBar** record specifies the attributes of the **up bars** or the **down bars** between multiple [series](#) of a line [chart group](#) and specifies the beginning of a collection of records as defined by the [Chart Sheet Substream ABNF](#). The first of these collections in the line chart group specifies the attributes of the up bars. The second specifies the attributes of the down bars. If this record exists, then the chart group type MUST be line and the field **cSer** in the record [SeriesList](#) MUST be greater than 1.

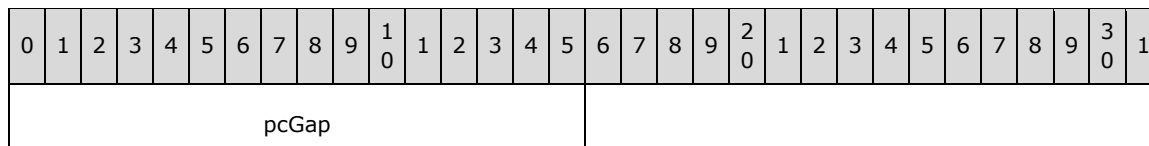

pcGap (2 bytes): A signed integer that specifies the width of the gap between the up bars or the down bars. MUST be a value between 0 and 500. The width of the gap in [SPRCs](#) can be calculated by the following formula:

$$\text{Width of the gap in SPRCs} = 1 + \text{pcGap}$$

2.4.93 DropDownObjIds

The **DropDownObjIds** record specifies the object identifiers that can be reused by the application when creating the dropdown objects for the **AutoFilter** at runtime in a **sheet**.

0	1	2	3	4	5	6	7	8	9	10	11	12	13	14	15	16	17	18	19	20	21	22	23	24	25	26	27	28	29	30	31
frtHeader																															
...																															
...																															
cidObj																rgidObj (variable)															
...																															

frtHeader (12 bytes): An [FrtHeader](#) structure. The **frtHeader.rt** field MUST be 0x0874.

cidObj (2 bytes): An unsigned integer that specifies the count of the object identifiers in **rgidObj**.

rgidObj (variable): An array of 2-byte unsigned integers that specifies the object identifiers that can be reused by the application when creating the dropdown objects for the AutoFilter at runtime in a sheet. These object identifiers MUST NOT equal an existing [ObjId](#) structure in the [worksheet](#) substream.

2.4.94 DSF

The **DSF** record is reserved and MUST be ignored.

0	1	2	3	4	5	6	7	8	9	10	11	12	13	14	15	16	17	18	19	20	21	22	23	24	25	26	27	28	29	30	31
reserved																															

reserved (2 bytes): MUST be zero, and MUST be ignored.

2.4.95 Dv

The **Dv** record specifies a single set of **data validation** criteria defined for a **range** on this **sheet**.

0	1	2	3	4	5	6	7	8	9	10	11	12	13	14	15	16	17	18	19	20	21	22	23	24	25	26	27	28	29	30	31
valType				A		B	C	D	mdImeMode						E	F	G			reserved											
PromptTitle (variable)																															
...																															
ErrorTitle (variable)																															

...
Prompt (variable)
...
Error (variable)
...
formula1 (variable)
...
formula2 (variable)
...
sqref (variable)
...

valType (4 bits): An unsigned integer that specifies the type of data validation. MUST be a value from the following table:

Value	Meaning
0x0	Specifies that the data validation allows any type of value and does not check for a type or range of values.
0x1	Specifies that the data validation checks for and allows whole number values satisfying the given condition.
0x2	Specifies that the data validation checks for and allows decimal values satisfying the given condition.
0x3	Specifies that the data validation checks for and allows a value that matches one in a list of values.
0x4	Specifies that the data validation checks for and allows date values satisfying the given condition.
0x5	Specifies that the data validation checks for and allows time values satisfying the given condition.
0x6	Specifies that the data validation checks for and allows text values whose length satisfies the given condition.
0x7	Specifies that the data validation uses a custom formula (section 2.2.2) to check the cell value.

A - errStyle (3 bits): An unsigned integer that specifies the style of error alert to be used in the error message which is shown if the **fShowErrorMsg** bit is set to 1. MUST be a value from the following table:

Value	Meaning
0x0	Specifies that the data validation error style uses a stop icon in the error alert.
0x1	Specifies that the data validation error style uses a warning icon in the error alert.

Value	Meaning
0x2	Specifies that the data validation error style uses an information icon in the error alert

B - fStrLookup (1 bit): A bit that specifies whether a list of valid inputs was specified for data validation. MUST be ignored if **valType** is not equal to 3.

C - fAllowBlank (1 bit): A bit that specifies whether the data validation treats empty or blank entries as valid.

D - fSuppressCombo (1 bit): A bit that specifies whether to suppress the display of the in-cell drop-down when the cell is **selected**. MUST be ignored if **valType** is not equal to 3.

mdImeMode (8 bits): An unsigned integer that specifies the **Input Method Editor (IME)** mode enforced by this data validation. This value is only used when the **input language** is one of the following languages:

- Chinese Simplified (Locale identifier = 2052)
- Chinese Traditional (Locale identifier = 1028)
- Japanese (Locale identifier = 1041)
- Korean (Locale identifier = 1042)

The input for the cell can be restricted to specific sets of characters, as specified by the value of **mdImeMode**. MUST be a value from the following table:

Value	Meaning
0x00	No Control
0x01	On
0x02	Off (English)
0x04	Hiragana
0x05	wide katakana
0x06	narrow katakana
0x07	Full-width alphanumeric
0x08	Half-width alphanumeric
0x09	Full-width hangul
0x0A	Half-width hangul

E - fShowInputMsg (1 bit): A bit that specifies whether to show an input prompt when the cell is selected.

F - fShowErrorMsg (1 bit): A bit that specifies whether to display an error message when the data validation fails.

G - typOperator (4 bits): An unsigned integer that specifies the relational operator used with this data validation. If **valType** is equal to 0, 3 or 7, the value of the **typOperator** field is undefined and MUST be ignored. MUST be a value from the following table:

Value	Meaning
0x0	Between
0x1	Not Between
0x2	Equals

Value	Meaning
0x3	Not Equals
0x4	Greater Than
0x5	Less Than
0x6	Greater Than or Equal To
0x7	Less Than or Equal To

reserved (8 bits): MUST be zero, and MUST be ignored.

PromptTitle (variable): An [XLUnicodeString](#) structure that specifies the title of the input prompt that is displayed when the cell is selected. The number of characters in this string MUST be less than or equal to 32.

ErrorTitle (variable): An [XLUnicodeString](#) structure that specifies the title of the error that is displayed when the cell value entered fails the data validation criteria. The number of characters in this string MUST be less than or equal to 32.

Prompt (variable): An [XLUnicodeString](#) structure that specifies the message shown in the input prompt that is displayed when the cell is selected. The number of characters in this string MUST be less than or equal to 255.

Error (variable): An [XLUnicodeString](#) structure that specifies the error message that is displayed when the cell value entered fails the data validation criteria. The number of characters in this string MUST be less than or equal to 225.

formula1 (variable): A [DVParsedFormula](#) structure that specifies the first formula (section 2.2.2) used in data validation.

If **valType** is equal to 0, this formula MUST be ignored and **formula1.cce** MUST be zero.

If **valType** is not one of 0, 3, or 7 and **typOperator** is equal to 0 or 1, this formula is used as the lesser of two bounding values and **formula1.cce** MUST be greater than or equal to 1.

Otherwise, this formula is the only formula for those cases, and **formula1.cce** MUST be greater than or equal to 1.

formula2 (variable): A [DVParsedFormula](#) structure that specifies the second formula used in data validation.

If **typOperator** is greater than or equal to 2 or **valType** is equal to 0, 3 or 7, this formula MUST be ignored and **formula2.cce** MUST be zero.

Otherwise, this formula is used as the greater of two bounding values and **formula2.cce** MUST be greater than or equal to 1.

sqref (variable): A [SqRefU](#) structure that specifies all the ranges over which data validation is applied. The value of **sqref.cref** MUST be greater than 0 and less than or equal to 432.

2.4.96 DVal

The **DVal** record specifies **data validation** information that is common to all cells in a **sheet** that have data validation applied and specifies the beginning of a collection of [Dv](#) records as defined by the [Worksheet Substream ABNF](#). The collection of [Dv](#) records specifies data validation criteria for individual **ranges** in the sheet.

0	1	2	3	4	5	6	7	8	9	10	11	12	13	14	15	16	17	18	19	20	21	22	23	24	25	26	27	28	29	30	31
A	B	C	reserved2													xLeft															
...																yTop															
...																idObj															
...																idvMac															
...																															

A - fWnClosed (1 bit): A bit that specifies whether the window used for input is closed.

B - reserved1 (1 bit): MUST be zero, and MUST be ignored.

C - unused (1 bit): Undefined and MUST be ignored.

reserved2 (13 bits): MUST be zero, and MUST be ignored.

xLeft (4 bytes): An unsigned integer that specifies the X-coordinate of the top left corner of the window used for input relative to the window used to display the sheet, in pixels. MUST be less than or equal to 65535.

yTop (4 bytes): An unsigned integer that specifies the Y-coordinate of the top left corner of the window used for input relative to the window used to display the sheet, in pixels. MUST be less than or equal to 65535.

idObj (4 bytes): A signed integer that specifies a reference to an [Obj](#) that represents the drop-down button displayed if a **cell** with a drop-down button is the **selected** cell at the time the file is saved. The value of this field specifies the value of the **cmo.id** field of the associated Obj record. MUST be greater than 0 and less than or equal to 32767 if the drop-down button is displayed. MUST be -1 if there is no drop-down button being displayed in the selected cell at the time the file is saved.

idvMac (4 bytes): An unsigned integer that specifies the number of Dv records that follow this record. MUST be greater than or equal to 0 and less than or equal to 65534. There MUST be exactly that many Dv records following this record.

2.4.97 DXF

The **DXF** record specifies a [differential format](#).

0	1	2	3	4	5	6	7	8	9	10	11	12	13	14	15	16	17	18	19	20	21	22	23	24	25	26	27	28	29	30	31
frtHeader																															
...																															
...																															
A	B	C	reserved													xfprops (variable)															

...

fmtHeader (12 bytes): An [FmtHeader](#) structure. The **fmtHeader.rt** field MUST be 2189.

A - unused1 (1 bit): Undefined and MUST be ignored. [<78>](#)

B - fNewBorder (1 bit): A bit that specifies whether it is possible to specify internal **border formatting** in **xfprops**. Internal border formatting is formatting that applies to borders that lie between a **range** of **cells**.

Value	Meaning
0x0	Specifies that internal border formatting cannot be used in xfprops .
0x1	Specifies that internal border formatting can be used in xfprops .

C - unused2 (1 bit): Undefined and MUST be ignored.

reserved (13 bits): MUST be zero, and MUST be ignored.

xfprops (variable): An [XFProps](#) structure that specifies the formatting properties.

2.4.98 DxGCol

The **DxGCol** record specifies the default column width for all **sheet** columns that do not have a column width explicitly specified. If an explicit column width was specified for a column, it is stored in a [ColInfo](#) record.

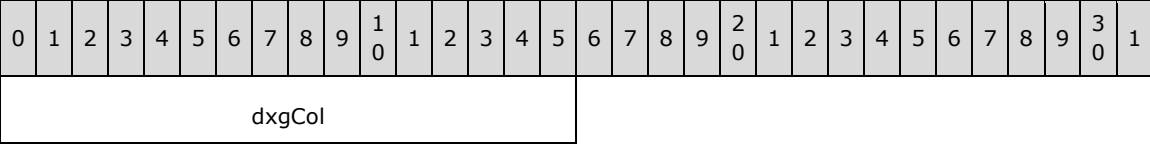

dxgCol (2 bytes): An unsigned integer that specifies the default column width. For the purposes of this field specification, a standard digit is defined to be the widest digit in the [Normal style font](#). The default column width is measured in the number of standard digits that fit in the column multiplied by 256 and rounded down. The value MUST be less than or equal to 65535 or be equal to 0xFFFFFFFF. If the value is 0xFFFFFFFF, this value MUST be ignored.

2.4.99 End

The **End** record specifies the end of a collection of records as defined by the [Chart Sheet Substream ABNF](#). The collection of records specifies properties of a [chart](#).

2.4.100 EndBlock

The **EndBlock** record specifies the end of a collection of records. [Future records](#) contained in this collection specify saved features to allow applications that do not support the feature to preserve the information. This record MUST have an associated [StartBlock](#) record. StartBlock and EndBlock pairs can be nested. Up to 100 levels of blocks can be nested.

EndBlock records MUST be written according to the following rules:

- If there exists a StartBlock record with **iObjectKind** equal to 0x0000 without a matching EndBlock, then a matching EndBlock record MUST exist immediately before the [End](#) record of the current [Axis Group](#).
- If there exists a StartBlock record with **iObjectKind** equal to 0x0002 without a matching EndBlock, then a matching EndBlock record MUST exist immediately before the End record of the current [AttachedLabel](#).
- If there exists a StartBlock record with **iObjectKind** equal to 0x0004 without a matching EndBlock, then a matching EndBlock record MUST exist immediately before the End record of the current [Axis](#).
- If there exists a StartBlock record with **iObjectKind** equal to 0x0005 without a matching EndBlock, then a matching EndBlock record MUST exist immediately before the End record of the current [chart group](#).
- If there exists a StartBlock record with **iObjectKind** equal to 0x0006 without a matching EndBlock, then a matching EndBlock record MUST exist immediately before the End record of the sequence of records containing the StartBlock and conforming to the [DAT](#) rule.
- If there exists a StartBlock record with **iObjectKind** equal to 0x0007 without a matching EndBlock, then a matching EndBlock record MUST exist immediately before the End record of the sequence of records containing the StartBlock and conforming to the FRAME rule.
- If there exists a StartBlock record with **iObjectKind** equal to 0x0009 without a matching EndBlock, then a matching EndBlock record MUST exist immediately before the End record of the current [Legend](#).
- If there exists a StartBlock record with **iObjectKind** equal to 0x000A without a matching EndBlock, then a matching EndBlock record MUST exist immediately before the End record of the current [Begin](#) and End collection that exists immediately after [LegendException](#) in the sequence of records conforming to the SERIESFORMAT rule.
- If there exists a StartBlock record with **iObjectKind** equal to 0x000C without a matching EndBlock, then a matching EndBlock record MUST exist immediately before the End record of the current [Series](#).
- If there exists a StartBlock record with **iObjectKind** equal to 0x000D without a matching EndBlock, then a matching EndBlock record MUST exist immediately before the End record of the current [Sheet](#).
- If there exists a StartBlock record with **iObjectKind** equal to 0x000E without a matching EndBlock, then a matching EndBlock record MUST exist immediately before the End record of the current SS production.
- If there exists a StartBlock record with **iObjectKind** equal to 0x000F without a matching EndBlock, then a matching EndBlock record MUST exist immediately before the End record of the sequence of records containing the StartBlock and conforming to the DROPBAR rule.

0	1	2	3	4	5	6	7	8	9	10	11	12	13	14	15	16	17	18	19	20	21	22	23	24	25	26	27	28	29	30	31
frtHeaderOld																															
iObjectKind																unused1 (optional)															
unused2 (optional)																unused3 (optional)															

frtHeaderOld (4 bytes): An [FrtHeaderOld](#) structure. The **frtHeaderOld.rt** field MUST be 0x0853.

iObjectKind (2 bytes): An unsigned integer that specifies the type of object that is encompassed by the block. MUST equal the **iObjectKind** field of the associated StartBlock record. MUST be a value from the following table:

Value	Object Type
0x0000	Axis Group
0x0002	AttachedLabel
0x0004	Axis
0x0005	chart group
0x0006	Dat
0x0007	Frame
0x0009	Legend
0x000A	LegendException
0x000C	Series
0x000D	Sheet
0x000E	DataFormat
0x000F	DropBar

unused1 (2 bytes): Undefined and MUST be ignored.

unused2 (2 bytes): Undefined and MUST be ignored.

unused3 (2 bytes): Undefined and MUST be ignored.

2.4.101 EndObject

The **EndObject** record specifies properties of an [Future Record Type \(FRT\)](#) as defined by the [Chart Sheet Substream ABNF](#). The collection of records specifies a feature saved as an FRT such that an application not supporting the feature can preserve it. This record MUST have an associated [StartObject](#) record. StartObject and EndObject pairs can be nested. Up to 100 levels of blocks can be nested.

0	1	2	3	4	5	6	7	8	9	10	11	12	13	14	15	16	17	18	19	20	21	22	23	24	25	26	27	28	29	30	31
ftrHeaderOld																															
iObjectKind																unused1 (optional)															
unused2 (optional)																unused3 (optional)															

ftrHeaderOld (4 bytes): An [FtrHeaderOld](#) structure. The **ftrHeaderOld.rt** field MUST be 0x0855.

iObjectKind (2 bytes): An unsigned integer that specifies the type of object that is encompassed by the block. MUST equal the **iObjectKind** field of the associated StartObject record. MUST be a value from the following table:

Value	Object Type
0x0010	YMult
0x0011	FrtFontList
0x0012	DataLabExt

unused1 (2 bytes): Undefined and MUST be ignored.

unused2 (2 bytes): Undefined and MUST be ignored.

unused3 (2 bytes): Undefined and MUST be ignored.

2.4.102 EntExU2

The **EntExU2** record specifies an application-specific cache of information. SHOULD NOT [<79>](#) be written, and SHOULD [<80>](#) be ignored.

0	1	2	3	4	5	6	7	8	9	10	11	12	13	14	15	16	17	18	19	20	21	22	23	24	25	26	27	28	29	30	31
rgb (variable)																															
...																															

rgb (variable): An array of bytes that specifies an application-specific cache of information. This cache exists for performance reasons only, and can be rebuilt based on information stored elsewhere in the file without affecting calculation results.

2.4.103 EOF

The **EOF** record specifies the end of a collection of records as defined by [Globals Substream ABNF](#), [Worksheet Substream ABNF](#), [Dialog Sheet Substream ABNF](#), [Chart Sheet Substream ABNF](#), [macro sheet](#) substream ABNF, [revision](#) stream ABNF, and [pivot cache](#) storage ABNF.

2.4.104 Excel9File

The **Excel9File** record is optional and is unused. It doesn't exist on files that were last saved in a specific version of the application [<81>](#).

2.4.105 ExternName

The **ExternName** record specifies an [external defined name](#), a User Defined Function (**UDF**) reference on a **XLL** or **COM add-in**, a [DDE data item](#) or an [OLE data item](#), depending on the value of the **virtPath** field in the preceding [SupBook](#) record. If the **cch** field in the preceding [SupBook](#) record is 0x3A01, then this record specifies a UDF reference. Otherwise if the **virtPath** field in the preceding [SupBook](#) record conforms to the ole-link rule specified in the [VirtualPath](#) ABNF, then this record specifies a DDE data item or an OLE data item. Otherwise, this record specifies an external defined name.

0	1	2	3	4	5	6	7	8	9	10	11	12	13	14	15	16	17	18	19	20	21	22	23	24	25	26	27	28	29	30	31
A	B	C	D	E	cf										F	body (variable)															
...																															

A - fBuiltIn (1 bit): A bit that specifies whether this record specifies a user-defined or built-in external defined name. The value **MUST** be 0 if this record specifies a DDE data item, an OLE data item or a UDF reference on a XLL or COM add-in. Otherwise, **MUST** be one of the following:

Value	Meaning
0	The external defined name is user-defined.
1	The external defined name is built-in.

B - fWantAdvise (1 bit): A bit that specifies whether this record is an automatic DDE data item or OLE data item. **MUST** be one of the following:

Value	Meaning
0	The record is an external defined name, a manual DDE data item, a manual OLE data item or a UDF reference on a XLL or COM add-in.
1	The record is either an automatic DDE data item or an automatic OLE data item.

C - fWantPict (1 bit): A bit that specifies whether this record's linked data uses a picture format. The value **MUST** be 0 if this record specifies an external defined name or a UDF reference on a XLL or COM add-in.

D - fOle (1 bit): A bit that, together with the value of **fOleLink**, specifies the structure of **body**. The value **MUST** be 0 if this record is an external defined name, an OLE data item or a UDF reference on a XLL or COM add-in. If this value is 1, **fOleLink** **MUST** be 0.

E - fOleLink (1 bit): A bit that, together with the value of **fOle**, specifies the structure of **body**. The value **MUST** be 0 if this record is an external defined name or a UDF reference on a XLL or COM add-in. If this value is 1, **fOle** **MUST** be 0 and this record specifies an OLE data item.

cf (10 bits): A signed integer that specifies the type of the cached clipboard format for a DDE data item or an OLE data item. The value **MUST** be 0 if this record is an external defined name or a UDF reference on a XLL or COM add-in. The value **MUST** be one of the values in the following table:

Value	Meaning
-1	There is no cached clipboard format.
0	This record is an external defined name or the cached clipboard format is text. For the text format, each line ends with a carriage return/linefeed (CR-LF) combination. A null character signals the end of the data.

Value	Meaning
2	Cached clipboard format is Enhanced Metafile.
5	Cached clipboard format is CSV (comma-delimited).
6	Cached clipboard format is Microsoft Symbolic Link (SYLK). SYLK is a format used to exchange data between applications.
7	Cached clipboard format is rich text (RTF).
8	Cached clipboard format is BIFF8 .
9	Cached clipboard format is Bitmap.
16	Cached clipboard format is a table created using a specific application <82>.
20	Cached clipboard format is BIFF3 .
30	Cached clipboard format is BIFF4 .
36	Cached clipboard format is Metafile Picture Format.
44	Cached clipboard format is Unicode text. Each line ends with a carriage return/linefeed (CR-LF) combination. A null character signals the end of the data.
63	Cached clipboard format is BIFF12 .

F - fIcon (1 bit): A bit that specifies whether linked data is displayed as an **icon**. The value MUST be 0 if this record is an external defined name, a DDE data item or a UDF reference on a XLL or COM add-in.

body (variable): A variable type field whose type and meaning is dictated by the values of **fOle** and **fOleLink**, as specified in the following table:

cch in the preceding SupBook	DDE data item or OLE data item	fOle	fOleLink	Meaning
!= 0x3A01	no	0	0	body is an ExternDocName that specifies an external defined name.
!= 0x3A01	yes	0	0	body is an ExternOleDdeLink that specifies an OLE data item or DDE data item.
!= 0x3A01	yes	0	1	
!= 0x3A01	yes	1	0	body is an ExternDdeLinkNoOper that specifies a DDE data item.
0x3A01	no	0	0	Body is an AddinUdf that specifies a UDF reference on a XLL or COM add-in.

2.4.106 ExternSheet

The **ExternSheet** record specifies a collection of [XTI](#) structures.

0	1	2	3	4	5	6	7	8	9	10	11	12	13	14	15	16	17	18	19	20	21	22	23	24	25	26	27	28	29	30	31
cXTI																rgXTI (variable)															
...																															

cXTI (2 bytes): An unsigned integer that specifies the number of elements in the **rgXTI** array.

rgXTI (variable): An array of XTI structures. The number of elements in this array MUST be **cXTI**.

2.4.107 ExtSST

The **ExtSST** record specifies the location of sets of strings within the shared string table, specified in the **SST** record. This record is used to perform a quick lookup of a string within the shared string table, given the string's index into the table (as specified in **LabelSst**). To do that, first use the string's index and the value of **dsst** to find the set the string is in, then use the corresponding element in **rgISSTInf** to find the beginning of that set, and finally search incrementally forward in that set to locate the string.

0	1	2	3	4	5	6	7	8	9	10	1	2	3	4	5	6	7	8	9	20	1	2	3	4	5	6	7	8	9	30	1		
dsst																rgISSTInf (variable)																	
...																																	

dsst (2 bytes): An unsigned integer that specifies the number of strings in each set specified by **ISSTInf**. Number of strings in each set except the last set MUST be equal to the value specified by the following formula:

$$\max(((\text{SST.cstUnique} / 128) + 1), 8)$$

Number of strings in the last set MUST be less than or equal to the value specified by the following formula:

$$\max(((\text{SST.cstUnique} / 128) + 1), 8)$$

rgISSTInf (variable): An array of ISSTInf structures. Each array element specifies the location of a set of strings within the SST record. The number of elements is determined by first evaluating the following formula **<83>**:

$$(\text{SST.cstUnique} \bmod \text{ExtSST.dsst})$$

If the result of the previous formula is equal to 0, then the number of elements MUST be equal to the value as specified by the following formula:

$$(\text{SST.cstUnique} / \text{ExtSST.dsst})$$

Otherwise, the number of elements MUST be equal to the value as specified by the following formula:

$$(\text{SST.cstUnique} / \text{ExtSST.dsst}) + 1$$

2.4.108 ExtString

The **ExtString** record specifies the **connection string** for a **query** that retrieves **external data**.

0	1	2	3	4	5	6	7	8	9	10	1	2	3	4	5	6	7	8	9	20	1	2	3	4	5	6	7	8	9	30	1		
frtHeaderOld																																	
string (variable)																																	

...
unused1 (variable)
...

frtHeaderOld (4 bytes): An [FrtHeaderOld](#) structure. The **frtHeaderOld.rt** field MUST be 2052.

string (variable): A [XLUnicodeString](#) structure that specifies the connection string.

unused1 (variable): Undefined and MUST be ignored. MUST exist if and only if the value of the following formula is less than 12 bytes:

size of **string** + size of **frtHeaderOld**

The size of this field, in bytes, is calculated using the following formula:

12 - (size of **string** + size of **frtHeaderOld**)

2.4.109 Fbi

The **Fbi** record specifies the **font** information at the time the scalable font is added to the chart. [<84>](#)

If the scaled font size matches the font size of the [Font](#) record (as specified by **ifnt** and **Font.dyHeight**), then that Font record is used to render the scaled fonts. If the scaled font size doesn't match the size of the Font record (as specified by **ifnt**), then a new Font record is added to the font table and the following **font scaling** algorithm is used to determine the scaled font size:

1. Start with the current **chart area** (section [2.2.3.17](#)) in dots or pixels at 96 DPI. Convert this size to Twips by multiplying width and height by 1440 Twips per inch / 96 dots per inch. Call this **dmix** and **dmiy** respectively.
2. If the scale basis **scab** is plot area (1), then apply the plot area scaling factors **PlotGrowth.dxPlotGrowth/65536** and **PlotGrowth.dyPlotGrowth/65536** to **dmix** and **dmiy** respectively.
3. Determine the scaled height basis by multiplying **twpHeightBasis** by **dmix / dmixBasis**; name this **twpX**.
4. Multiply **twpHeightBasis** by **dmiy / dmiyBasis**; call this **twpY**.
5. Take the smaller of **twpX** and **twpY** and name this **twpNew**. If this value is less than 10, set it equal to 10.
6. Round this value to the nearest quarter **point**.
7. If the value of **twpHeightBasis** is between 160 (inclusive) and 240 (inclusive), and the value of **twpNew** is between 120 (inclusive) and 160, make **twpNew** equal to 160. If the value of **Fbi.twpHeightBasis** is between 160 (inclusive) and 240 (inclusive), and value of **twpNew** is between 240 and 280 (inclusive), make **twpNew** equal to 240.
8. **twpNew** is the new scaled font size. If the **dyHeight** field of the Font record (as specified by **Fbi.ifnt**) is the same as the value of **twpNew**, then load that Font record for the scaled font. If it isn't the same, **twpNew** is the new scaled font size and a new Font record is added to the font table.

0	1	2	3	4	5	6	7	8	9	10	11	12	13	14	15	16	17	18	19	20	21	22	23	24	25	26	27	28	29	30	31
dmixBasis																dmiyBasis															
twpHeightBasis																scab															
ifnt																															

dmixBasis (2 bytes): An unsigned integer that specifies the font width, in **twips**, when the font was first applied. MUST be greater than or equal to 0 and less than or equal to 0x7FFF.

dmiyBasis (2 bytes): An unsigned integer that specifies the font height, in twips, when the font was first applied. MUST be greater than or equal to 0 and less than or equal to 0x7FFF.

twpHeightBasis (2 bytes): An unsigned integer that specifies the default font height in twips. MUST be greater than or equal to 20 and less than or equal to 8180.

scab (2 bytes): A Boolean (section [2.5.14](#)) that specifies the scale to use. The value MUST be one of the following values:

Value	Meaning
0x0000	Scale by chart area (section 2.2.3.17)
0x0001	Scale by plot area

ifnt (2 bytes): A [FontIndex](#) structure that specifies the font. MUST be used when **ifnt** is less than or equal to 255.

2.4.110 Fbi2

The **Fbi2** record specifies the **font** information at the time the scalable font is added to the chart. [<85>](#)

0	1	2	3	4	5	6	7	8	9	10	11	12	13	14	15	16	17	18	19	20	21	22	23	24	25	26	27	28	29	30	31
dmixBasis																dmiyBasis															
twpHeightBasis																scab															
ifnt																															

dmixBasis (2 bytes): An unsigned integer that specifies the font width, in **twips**, when the font was first applied. MUST be greater than or equal to 0 and less than or equal to 0x7FFF.

dmiyBasis (2 bytes): An unsigned integer that specifies the font height, in twips, when the font was first applied. MUST be greater than or equal to 0 and less than or equal to 0x7FFF.

twpHeightBasis (2 bytes): An unsigned integer that specifies the default font height in twips. MUST be greater than or equal to 20 and less than or equal to 8180.

scab (2 bytes): A Boolean (section [2.5.14](#)) that specifies the scale to use. The value MUST be one of the following values:

Value	Meaning
0x0000	Scale by chart area (section 2.2.3.17)
0x0001	Scale by plot area

ifnt (2 bytes): A [FontIndex](#) structure that specifies the font. MUST be used when **ifnt** is greater than 255.

2.4.111 Feat

The **Feat** record specifies [Shared Feature](#) data.

0	1	2	3	4	5	6	7	8	9	10	11	12	13	14	15	16	17	18	19	20	21	22	23	24	25	26	27	28	29	30	31
frtHeader																															
...																															
...																															
isf																reserved1								reserved2							
...																								cref							
...				cbFeatData																											
...				reserved3																refs (variable)											
...																															
rgbFeat (variable)																															
...																															

frtHeader (12 bytes): An [FrtHeader](#) structure. **frtHeader.rt** MUST be 0x0868.

isf (2 bytes): A [SharedFeatureType](#) enumeration that specifies the type of Shared Feature data stored in the **rgbFeat** field. MUST NOT be ISFLIST.

reserved1 (1 byte): Reserved and MUST be zero.

reserved2 (4 bytes): MUST be zero, and MUST be ignored.

cref (2 bytes): An unsigned integer that specifies the number of elements in the **refs** field.

cbFeatData (4 bytes): An unsigned integer whose meaning is determined by the value of **isf**. If **isf** is ISFFEC2, this field specifies the size in bytes of Shared Feature data that is stored in the **rgbFeat** field. Otherwise, this field MUST be zero and MUST be ignored.

reserved3 (2 bytes): MUST be zero, and MUST be ignored.

refs (variable): An array of [Ref8U](#) structures. Specifies the **ranges** referenced by the Shared Feature. The number of elements in the array is specified by **cref**.

rgbFeat (variable): A variable type field that specifies Shared Feature data. The type is dictated by the value of **isf**, as specified in the following table:

Value of isf	Meaning
ISFPROTECTION	Value is a FeatProtection structure.
ISFFEC2	Value is a FeatFormulaErr2 structure.
ISFFACTOID	Value is a FeatSmartTag structure.

2.4.112 FeatHdr

The **FeatHdr** record specifies common information for [Shared Features](#) and specifies the beginning of a collection of records as defined by the [Globals Substream ABNF](#), [macro sheet](#) substream ABNF and [worksheet](#) substream ABNF. The collection of records specifies Shared Feature data.

0	1	2	3	4	5	6	7	8	9	10	11	12	13	14	15	16	17	18	19	20	21	22	23	24	25	26	27	28	29	30	31
frtHeader																															
...																															
...																															
isf																reserved								cbHdrData							
...																								rgbHdrData (variable)							
...																															

frtHeader (12 bytes): An [FrtHeader](#) structure. The **frtHeader.rt** MUST be 0x0867.

isf (2 bytes): A [SharedFeatureType](#) enumeration that specifies the type of Shared Feature. MUST be ISFPROTECTION, ISFFEC2 or ISFFACTOID.

reserved (1 byte): Reserved and MUST be 1.

cbHdrData (4 bytes): An unsigned integer that specifies whether **rgbHdrData** exists. MUST be a value from the following table:

Value	Meaning
0x00000000	rgbHdrData MUST NOT exist.
0xFFFFFFFF	rgbHdrData MUST exist.

rgbHdrData (variable): A variable type field containing data whose type and meaning is dictated by the value of the **isf** field of this record and the value of the **dt** field of the [BOF](#) record preceding this record, as specified in the following table:

Value of isf	Containing substream	Meaning of rgbHdrData
ISFPROTECTION	Globals	An EnhancedProtection structure that specifies common protection rule settings.
ISFFEC2	Globals	rgbHdrData MUST NOT exist.

Value of isf	Containing substream	Meaning of rgbHdrData
ISFFACTOID	Globals	A PropertyBagStore as defined in [MS-OSHARED] section 2.3.4.1 that specifies smart tag header data.
	Worksheet or Macro Sheet	rgbHdrData MUST NOT exist.

2.4.113 FeatHdr11

The **FeatHdr11** record specifies common information for all **tables** on a **sheet** and specifies the beginning of a collection as specified by the [Worksheet Substream ABNF](#). The collection of records specifies table information, **AutoFilter** information and data used for sorting a **range**

0	1	2	3	4	5	6	7	8	9	10	11	12	13	14	15	16	17	18	19	20	21	22	23	24	25	26	27	28	29	30	31
frtHeader																															
...																															
...																															
isf																reserved1								reserved2							
...																								reserved3							
...																								idListNext							
...																								reserved4							
...																															

frtHeader (12 bytes): An [FrtHeader](#). The **frtHeader.rt** field MUST be 0x0871.

isf (2 bytes): A [SharedFeatureType](#) enumeration that specifies the type of [Shared Feature](#). MUST be ISFLIST.

reserved1 (1 byte): Reserved and MUST be 1.

reserved2 (4 bytes): MUST be 0xFFFFFFFF and MUST be ignored.

reserved3 (4 bytes): MUST be 0xFFFFFFFF and MUST be ignored.

idListNext (4 bytes): An unsigned integer that specifies the next identifier to try when assigning a unique identifier to a new table.

reserved4 (2 bytes): MUST be zero, and MUST be ignored.

2.4.114 Feature11

The **Feature11** record specifies specific [shared feature](#) data. The only shared feature type stored in this record is a **table** in a [worksheet](#).

feature (variable): A [TableFeatureType](#) structure.

If this record is not a [Feature12](#) record, then these rules apply:

- The **feature.frtRefHeaderU.rt** field MUST be 0x0872.
- **It** of the embedded TableFeatureType MUST NOT be LEXTERNALDATA.
- If **crwHeader** of the embedded TableFeatureType is zero then and **fSingleCell** of the embedded TableFeatureType MUST be zero.
- **fLoadTotalFmla** and **fLoadTotalStr** of all embedded [Feat11FieldDataItem](#) MUST be zero.

0	1	2	3	4	5	6	7	8	9	10	11	12	13	14	15	16	17	18	19	20	21	22	23	24	25	26	27	28	29	30	31
frtRefHeaderU																															
...																															
...																															
isf																reserved1								reserved2							
...																								cref2							
...				cbFeatData																											
...				reserved3																refs2 (variable)											
...																															
rgbFeat (variable)																															
...																															

frtRefHeaderU (12 bytes): An [FrtRefHeaderU](#). The **frtRefHeaderU.rt** field MUST be 0x0872. The **frtRefHeaderU.ref8** MUST refer to a **range** of cells associated with this record.

isf (2 bytes): A [SharedFeatureType](#) enumeration that specifies the type of Shared Feature data stored in the **rgbFeat** field. MUST be ISFLIST.

reserved1 (1 byte): Reserved and MUST be zero.

reserved2 (4 bytes): MUST be zero, and MUST be ignored.

cref2 (2 bytes): An unsigned integer that specifies the count of [Ref8U](#) records within the **refs2** field.

cbFeatData (4 bytes): An unsigned integer that specifies the size in bytes of the **rgbFeat** variable-size field. If the value is 0x0000, the size of the **rgbFeat** field is calculated by the following formula:

$$\text{size of rgbFeat} = \text{total size of record in bytes} - \text{size of refs2 in bytes} - 27 \text{ bytes}$$

reserved3 (2 bytes): MUST be zero, and MUST be ignored.

refs2 (variable): An array of Ref8U structures that specifies references to ranges of **cells** within the worksheet associated with the feature. The count of records within this field is specified by the **cref2** field.

rgbFeat (variable): A variable-size structure that contains feature specific data. The size of the structure is specified by the **cbFeatData** field. This field MUST contain a TableFeatureType structure.

2.4.115 Feature12

The **Feature12** record specifies [shared feature](#) data that is used to describe a table in a [worksheet](#). This record is used to encapsulate a table that has properties not supported by the [Feature11](#) record.

0	1	2	3	4	5	6	7	8	9	10	11	12	13	14	15	16	17	18	19	20	21	22	23	24	25	26	27	28	29	30	31
feature (variable)																															
...																															

feature (variable): A Feature11 record with additional properties enabled. The **feature.frtRefHeaderU.rt** field MUST be 0x0878.

On or more of these additional properties MUST be present in a Feature12 record:

- **It** of the embedded [TableFeatureType](#) structure is LEXTERNALDATA.
- **crwHeader** and **fSingleCell** of the embedded TableFeatureType structure are zero.
- An embedded [Feat11FieldDataItem](#) structure has **fLoadTotalFmla** or **fLoadTotalStr** equal to 1.

2.4.116 FileLock

The **FileLock** record specifies that the **shared workbook** was **locked** by a particular user.

0	1	2	3	4	5	6	7	8	9	10	11	12	13	14	15	16	17	18	19	20	21	22	23	24	25	26	27	28	29	30	31
IPurpose																															
stUsrName (variable)																															
...																															
unused (variable)																															
...																															

IPurpose (4 bytes): An unsigned integer that specifies the purpose of the file lock. MUST be one of the following:

Value	Meaning
0x00000000	The shared workbook is not locked.
0x00010001	The shared workbook is locked for writing or releasing user information.
0x00010002	The shared workbook is locked for merging two revisions.
0x00010004	The shared workbook is locked to make it exclusive.

Value	Meaning
0x00010008	The shared workbook is locked to be deleted or renamed.

stUserName (variable): An [XLUnicodeString](#) structure that specifies the **user name**. The string length MUST be less than or equal to 52.

unused (variable): Undefined and MUST be ignored. This size of this field in bytes is specified by the following formula:

$$\text{size} = 158 - (\text{byte count of stUserName})$$

2.4.117 FilePass

The **FilePass** record specifies the encryption algorithm used to encrypt the **workbook** and the structure that is used to verify the password provided when attempting to open the workbook. If this record exists, the workbook MUST be encrypted. Refer to the [Encryption \(Password to Open\)](#) overview to understand the details of workbook files that have been encrypted.

0	1	2	3	4	5	6	7	8	9	10	11	12	13	14	15	16	17	18	19	20	21	22	23	24	25	26	27	28	29	30	31
wEncryptionType																encryptionInfo (variable)															
...																															

wEncryptionType (2 bytes): A Boolean (section [2.5.14](#)) that specifies the encryption type. MUST be a value from the following table: [<86>](#)

Value of wEncryptionType	Meaning
0x0000	XOR obfuscation
0x0001	RC4 encryption. For more information about RC4 encryption, see [SCHNEIER] section 17.1

encryptionInfo (variable): A variable type field. The type and meaning of this field is dictated by the value of **wEncryptionType**. If **wEncryptionType** is equal to 0x0000, this field is an [XORObfuscation](#) structure. If **wEncryptionType** is equal to 0x0001, this field is an RC4 encryption header structure as specified in [\[MS-OFFCRYPTO\]](#), 2.3.5.1 or [\[MS-OFFCRYPTO\]](#), 2.3.6.1 depending on the value of the first two bytes. The first two bytes of the RC4 encryption header structure MUST be a value from the following table:

Value of the first two bytes of encryptionInfo	Type of encryptionInfo
0x0001	RC4 encryption header structure [MS-OFFCRYPTO] , 2.3.6.1
0x0002, 0x0003, or 0x0004	RC4 CryptoAPI encryption header structure [MS-OFFCRYPTO] , 2.3.5.1

2.4.118 FileSharing

The **FileSharing** record specifies file sharing options.

0	1	2	3	4	5	6	7	8	9	10	11	12	13	14	15	16	17	18	19	20	21	22	23	24	25	26	27	28	29	30	31		
fReadOnlyRec																wResPass																	
iNoResPass (optional)																stUNUsername (variable)																	
...																																	

fReadOnlyRec (2 bytes): A Boolean (section [2.5.14](#)) that specifies whether the **read-only recommended** option is selected for this file. If the value is 1, the read-only recommended is selected for this file.

wResPass (2 bytes): An unsigned integer that specifies the password verifier for **write reservation**. If the value is 0, there is no write reservation password. The algorithm is specified in [Password Verifier Algorithm](#).

iNoResPass (2 bytes): An unsigned integer that specifies that there is no write reservation password. This field exists if and only if **wResPass** is 0. The value MUST be 0.

stUNUsername (variable): An [XLUnicodeString](#) structure that specifies the **user name** that added the write reservation password. This field exists if and only if **wResPass** is not 0. The value of **stUNUsername.cch** MUST be less than or equal to 54.

2.4.119 FilterMode

The **FilterMode** record specifies that the containing **sheet** data was filtered. If this record exists one or more [AutoFilter](#) or [AutoFilter12](#) records MUST exist within the containing sheet.

2.4.120 FnGroupName

The **FnGroupName** record specifies a user-defined **function category** in the current **workbook**.

0	1	2	3	4	5	6	7	8	9	10	11	12	13	14	15	16	17	18	19	20	21	22	23	24	25	26	27	28	29	30	31		
rgch (variable)																																	
...																																	

rgch (variable): An [XLUnicodeString](#) structure that specifies the function category name. MUST be less than or equal to 32 characters in length. The value of this field MUST NOT equal any of the **category (2)** names specified by FnGroupName and [FnGrp12](#).

2.4.121 FnGrp12

The **FnGrp12** record specifies the name of a user-defined **function category** in the current **workbook**. The user-defined function categories include the function categories defined in both [FnGroupName](#) records and FnGrp12 records. The sum of the built-in function categories as specified by [BUILTINFNGROUPCOUNT](#) and the user defined function categories in the current workbook MUST be

less than or equal to 256. This record specifies the name of a function category after the 32nd function category.

0	1	2	3	4	5	6	7	8	9	10	11	12	13	14	15	16	17	18	19	20	21	22	23	24	25	26	27	28	29	30	31
frtHeader																															
...																															
...																															
astFnGrp (variable)																															
...																															

frtHeader (12 bytes): An [FrtHeader](#) structure. The **frtHeader.rt** field MUST be 0x0898.

astFnGrp (variable): An [XLUnicodeString](#) structure that specifies the name of the function category. The length of this string MUST be less than or equal to 32 characters. The value of this field MUST NOT equal any of the **category (2)** names specified by FnGrp12 and FnGroupName.

2.4.122 Font

The **Font** record specifies a **font** and font formatting information.

0	1	2	3	4	5	6	7	8	9	10	11	12	13	14	15	16	17	18	19	20	21	22	23	24	25	26	27	28	29	30	31		
dyHeight																A	B	C	D	E	F	G	H	reserved									
icv																bls																	
sss																uls								bFamily									
bCharSet								unused3								fontName (variable)																	
...																																	

dyHeight (2 bytes): An unsigned integer that specifies the height of the font in **twips**. SHOULD [<87>](#) be greater than or equal to 20 and less than or equal to 8191. MUST be greater than or equal to 20 and less than or equal to 8191, or 0.

A - unused1 (1 bit): Undefined and MUST be ignored.

B - fItalic (1 bit): A bit that specifies whether the font is italic.

C - unused2 (1 bit): Undefined and MUST be ignored. MUST be 1 when **uls** is greater than 0x00.

D - fStrikeOut (1 bit): A bit that specifies whether the font has **strikethrough formatting** applied.

E - fOutline (1 bit): A bit that specifies whether the font has an **outline effect** applied.

F - fShadow (1 bit): A bit that specifies whether the font has a **shadow effect** applied.

G - fCondense (1 bit): A bit that specifies whether the font is condensed.

H - fExtend (1 bit): A bit that specifies whether the font is extended.

reserved (8 bits): MUST be zero, and MUST be ignored.

icv (2 bytes): An unsigned integer that specifies the color of the font. The value SHOULD [<88>](#) be an [IcvFont](#) value. The value MUST be an IcvFont value, or 0.

bls (2 bytes): An unsigned integer that specifies the font weight. The value SHOULD [<89>](#) be a value from the following table. This value MUST be 0, or greater than or equal to 100 and less than or equal to 1000.

Value	Meaning
400	Normal font weight
700	Bold font weight

sss (2 bytes): An unsigned integer that specifies whether superscript, subscript, or normal script is used. The value MUST be one of the following:

Value	Meaning
0x0000	Normal script
0x0001	Superscript
0x0002	Subscript

uls (1 byte): An unsigned integer that specifies the underline **style**. The value MUST be one of the following:

Value	Meaning
0x00	No underline
0x01	Single underline
0x02	Double underline
0x21	Single accounting
0x22	Double accounting

bFamily (1 byte): An unsigned integer that specifies the **font family** this font belongs to. MUST be a value from the following table: [<90>](#)

Value	Meaning
0x00	Not applicable
0x01	Roman
0x02	Swiss
0x03	Modern

Value	Meaning
0x04	Script
0x05	Decorative

For more information about font family, see the Windows API LOGFONT structure in [\[MSDN-FONTS\]](#).

bCharSet (1 byte): An unsigned integer that specifies the **character set**. MUST be a value from the following table:

Value	Meaning
0x00	ANSI_CHARSET
0x01	DEFAULT_CHARSET
0x02	SYMBOL_CHARSET
0x4D	MAC_CHARSET
0x80	SHIFTJIS_CHARSET
0x81	HANGEUL_CHARSET
0x81	HANGUL_CHARSET
0x82	JOHAB_CHARSET
0x86	GB2312_CHARSET
0x88	CHINESEBIG5_CHARSET
0xA1	GREEK_CHARSET
0xA2	TURKISH_CHARSET
0xA3	VIETNAMESE_CHARSET
0xB1	HEBREW_CHARSET
0xB2	ARABIC_CHARSET
0xBA	BALTIC_CHARSET
0xCC	RUSSIAN_CHARSET
0xDD	THAI_CHARSET
0xEE	EASTEUROPE_CHARSET
0xFF	OEM_CHARSET

For more information about character set, see the Windows API LOGFONT structure in [\[MSDN-FONTS\]](#).

unused3 (1 byte): Undefined and MUST be ignored.

fontName (variable): A [ShortXLUnicodeString](#) structure that specifies the name of this font. String length MUST be greater than or equal to 1 and less than or equal to 31. The **fontName.fHighByte** field MUST equal 1. MUST NOT contain any null characters.

2.4.123 FontX

The **FontX** record specifies the **font** for a given text element. The [Font](#) record referenced by **iFont** can exist in this [chart sheet](#) substream or the **workbook**.

0	1	2	3	4	5	6	7	8	9	10	11	12	13	14	15	16	17	18	19	20	21	22	23	24	25	26	27	28	29	30	31
iFont																															

iFont (2 bytes): An unsigned integer that specifies the font to use for subsequent records. This font can either be the default font of the [chart](#), part of the collection of Font records following the [FrtFontList](#) record, or part of the collection of Font records in the [Globals Substream](#). If **iFont** is 0x0000, this record specifies the default font of the chart. If **iFont** is less than or equal to the number of Font records in the Globals Substream, **iFont** is a one-based index to a Font record in

the Globals Substream. Otherwise **iFont** is a one-based index into the collection of Font records in this chart sheet substream where the index is equal to **iFont** – n, where n is the number of Font records in the Globals Substream.

2.4.124 Footer

The **Footer** record specifies the footer text of the current **sheet** when printed.

0	1	2	3	4	5	6	7	8	9	10	11	12	13	14	15	16	17	18	19	20	21	22	23	24	25	26	27	28	29	30	31
ast (variable)																															
...																															

ast (variable): An [XLUnicodeString](#) structure that specifies the footer text for the current sheet. It is optional and exists only if the record size is not zero. The footer text appears at the bottom of every page when printed. The length of the text **MUST** be less than or equal to 255. The footer text can contain special commands, for example a placeholder for the page number, current date or text formatting attributes, as specified in the **ABNF** grammar for special commands as specified in [Header](#).

2.4.125 ForceFullCalculation

The **ForceFullCalculation** record specifies the value of the forced **calculation mode** for this **workbook**.

0	1	2	3	4	5	6	7	8	9	10	11	12	13	14	15	16	17	18	19	20	21	22	23	24	25	26	27	28	29	30	31
frtHeader																															
...																															
...																															
fNoDeps																															

frtHeader (12 bytes): An [FrtHeader](#). The **frtHeader.rt** field **MUST** be 0x08A3.

fNoDeps (4 bytes): A Boolean (section [2.5.14](#)) that specifies whether all cells in the workbook are calculated or not. **MUST** be one of the following:

Value	Meaning
0	Dependencies are respected and only formulas (section 2.2.2) that depend on cells that changed in the workbook are calculated.
1	Dependencies are ignored and all cell formulas in this workbook fully calculate every time a calculation is triggered.

2.4.126 Format

The **Format** record specifies a **number format**.

0	1	2	3	4	5	6	7	8	9	10	11	12	13	14	15	16	17	18	19	20	21	22	23	24	25	26	27	28	29	30	31		
ifmt																stFormat (variable)																	
...																																	

ifmt (2 bytes): An [IFmt](#) structure that specifies the identifier of the **format string** specified by **stFormat**. The value of **ifmt.ifmt** SHOULD<91> be a value within one of the following ranges. The value of **ifmt.ifmt** MUST be a value within one of the following ranges or within 383 to 392.

- 5 to 8
- 23 to 26
- 41 to 44
- 63 to 66
- 164 to 382

stFormat (variable): An [XLUnicodeString](#) structure that specifies the format string for this number format. The format string indicates how to format the numeric value of the **cell**. The length of this field MUST be greater than or equal to 1 character and less than or equal to 255 characters. For more information about how format strings are interpreted, see [\[ECMA-376\]](#) Part 4: Markup Language Reference, section 3.8.31.

For a string to be considered a valid format string, it MUST be well-formed according to the following **ABNF** specification.

ABNF Grammar for number format strings

These definitions are for en-US **locale**. International consideration as specified in [\[ECMA-376\]](#) Part 4: Markup Language Reference, section 3.8.31 MUST be accounted for and the ABNF MUST be modified accordingly for specific international number formats.

The following rules are not expressed in the ABNF grammar, but apply to the grammar:

1. In the following ABNF specification, the following tokens in the first table that follows can occur 0 or more times anywhere in the grammar, as long as they do not break apart the elements in the second table that follows:

Token
LITERAL-STRING
LITERAL-CHAR-REPEAT
LITERAL-CHAR-SPACE

Elements
INTL*

Elements
LITERAL*
NFDateTimeToken
NFPartExponential
NFPartCond
NFPartLocaleID
NFPartColor
NFPartIntNum
NFPartStrColor

Elements
INTL*
LITERAL*
NFDateTimeToken
NFPartExponential
NFPartCond
NFPartLocaleID
NFPartColor
NFPartIntNum
NFPartStrColor

2. The following token MUST occur 0 or 1 times in each section as defined in [ECMA-376] Part 4: Markup Language Reference, section 3.8.31.

NFPartLocaleID

NFAbsTimeToken MUST occur 0 or 1 times in NFDateTime.

An absolute time token, such as NFPartAbsHour, MUST NOT coexist with a non-absolute equivalent token, such as NFPartHour, in NFDateTime.

Following is the ABNF grammar for number format strings.

```
All = ([NFPartColor] NFPartCond NFGeneral) / NFAnyNoCond / (NFAnyNoText ASCII-SEMICOLON NFAny) /
      (NFAnyNoText ASCII-SEMICOLON NFAnyNoText ASCII-SEMICOLON NFAnyNoCond) / (NFAnyNoText
      ASCII-SEMICOLON NFAnyNoText ASCII-SEMICOLON NFAnyNoTextNoCond ASCII-SEMICOLON [NFText /
      NFGeneral])
```

```
NFAny = [NFPartColor] (([NFPartCond] NFNumber) / NFText / ([NFPartCond] NFFraction) /
      ([NFPartCond] [NFDateTime] [NFGeneral] [NFDateTime]))
```

```

NFAnyNoText = [NFPartColor] [NFPartCond] (NFNumber / NFFraction / ([NFDateTime] [NFGeneral]
[NFDateTime]))

NFAnyNoCond = [NFPartColor] (NFNumber / NFText / NFFraction / ([NFDateTime] [NFGeneral]
[NFDateTime]))

NFAnyNoTextNoCond = [NFPartColor] (NFNumber / NFFraction / ([NFDateTime] [NFGeneral]
[NFDateTime]))

NFGeneral = INTL-NUMFMT-GENERAL

NFNumber = NFPartNum [NFPartExponential NFPartNum] *INTL-CHAR-NUMGRP-SEP *INTL-AMPM

NFDateTimeToken = NFPartYear / NFPartMonth / NFPartDay / NFPartHour / NFPartMinute / NFPartSecond
/ NFAbsTimeToken

NFAbsTimeToken = NFPartAbsHour / NFPartAbsSecond / NFPartAbsMinute

NFDateTime = *INTL-AMPM (1*(NFDateTimeToken) *(NFDateTimeToken / NFPartSubSecond / INTL-CHAR-
DATE-SEP / INTL-CHAR-TIME-SEP / INTL-AMPM))

NFText = (1*ASCII-COMMERCIAL-AT *(ASCII-COMMERCIAL-AT / INTL-AMPM)) / (*(ASCII-COMMERCIAL-AT /
INTL-AMPM) 1*ASCII-COMMERCIAL-AT)

NFFraction = NFPartFraction ASCII-SOLIDUS NFPartFraction [NFPartNum] *INTL-AMPM

NFPartNum = 1*NFPartNumToken2 *(NFPartNumToken2 / ASCII-PERCENT-SIGN) / (*(NFPartNumToken2 /
ASCII-PERCENT-SIGN) 1*NFPartNumToken2)

NFPartExponential = ASCII-CAPITAL-LETTER-E NFPartSign

NFPartYear = 2(ASCII-SMALL-LETTER-Y) / 4(ASCII-SMALL-LETTER-Y)

NFPartMonth = 1*5(ASCII-SMALL-LETTER-M)

NFPartDay = 1*4(ASCII-SMALL-LETTER-D)

NFPartHour = 1*2(ASCII-SMALL-LETTER-H)

NFPartAbsHour = ASCII-LEFT-SQUARE-BRACKET 1*ASCII-SMALL-LETTER-H ASCII-RIGHT-SQUARE-BRACKET

NFPartMinute = 1*2(ASCII-SMALL-LETTER-M)

NFPartAbsMinute = ASCII-LEFT-SQUARE-BRACKET 1*ASCII-SMALL-LETTER-M ASCII-RIGHT-SQUARE-BRACKET

NFPartSecond = 1*2(ASCII-SMALL-LETTER-S)

NFPartAbsSecond = ASCII-LEFT-SQUARE-BRACKET 1*ASCII-SMALL-LETTER-S ASCII-RIGHT-SQUARE-BRACKET

NFPartSubSecond = INTL-CHAR-DECIMAL-SEP 1*3ASCII-DIGIT-ZERO

NFPartCond = ASCII-LEFT-SQUARE-BRACKET NFPartCompOper NFPartCondNum ASCII-RIGHT-SQUARE-BRACKET

NFPartCompOper = (ASCII-LESS-THAN-SIGN [ASCII-EQUALS-SIGN / ASCII-GREATER-THAN-SIGN]) / ASCII-
EQUALS-SIGN / (ASCII-GREATER-THAN-SIGN [ASCII-EQUALS-SIGN])

NFPartLocaleID = ASCII-LEFT-SQUARE-BRACKET ASCII-DOLLAR-SIGN 1*UTF16-ANY [ASCII-HYPHEN-MINUS
3*8ASCII-DIGIT-HEXADECIMAL] ASCII-RIGHT-SQUARE-BRACKET

```

$$\text{NFPartCondNum} = [\text{ASCII-HYPHEN-MINUS}] \text{NFPartIntNum} [\text{INTL-CHAR-DECIMAL-SEP} \text{NFPartIntNum}]$$

$$[\text{NFPartExponential} \text{NFPartIntNum}]$$

$$\text{NFPartSign} = \text{ASCII-PLUS-SIGN} / \text{ASCII-HYPHEN-MINUS}$$

$$\text{NFPartColor} = \text{ASCII-LEFT-SQUARE-BRACKET} \text{INTL-COLOR} / (\text{NFPartStrColor} \text{NFPart1To56}) \text{ASCII-RIGHT-SQUARE-BRACKET}$$

$$\text{NFPart1To56} = \text{NFPartNumber1To9} / \text{NFPartNumber1To4} \text{ASCII-DIGIT} / \text{ASCII-DIGIT-FIVE} (\text{ASCII-DIGIT-ZERO} / \text{NFPartNumber1To6})$$

$$\text{NFPartIntNum} = 1 * \text{ASCII-DIGIT}$$

$$\text{NFPartNumToken1} = \text{ASCII-NUMBER-SIGN} / \text{ASCII-QUESTION-MARK} / \text{ASCII-DIGIT-ZERO}$$

$$\text{NFPartNumToken2} = \text{NFPartNumToken1} / \text{INTL-CHAR-DECIMAL-SEP} / \text{INTL-CHAR-NUMGRP-SEP}$$

$$\text{NFPartFraction} = (1 * \text{NFPartIntNum} * (\text{NFPartIntNum} / \text{ASCII-PERCENT-SIGN})) / ((\text{NFPartIntNum} / \text{ASCII-PERCENT-SIGN}) 1 * \text{NFPartIntNum}) / (1 * \text{NFPartNumToken1} * (\text{NFPartNumToken1} / \text{ASCII-PERCENT-SIGN})) / ((\text{NFPartNumToken1} / \text{ASCII-PERCENT-SIGN}) 1 * \text{NFPartNumToken1})$$

$$\text{NFPartNumber1To4} = \text{ASCII-DIGIT-ONE} / \text{ASCII-DIGIT-TWO} / \text{ASCII-DIGIT-THREE} / \text{ASCII-DIGIT-FOUR}$$

$$\text{NFPartNumber1To6} = \text{NFPartNumber1To4} / \text{ASCII-DIGIT-FIVE} / \text{ASCII-DIGIT-SIX}$$

$$\text{NFPartNumber1To9} = \text{NFPartNumber1To6} / \text{ASCII-DIGIT-SEVEN} / \text{ASCII-DIGIT-EIGHT} / \text{ASCII-DIGIT-NINE}$$

$$\text{NFPartStrColor} = \text{ASCII-CAPITAL-LETTER-C} \text{ASCII-SMALL-LETTER-O} \text{ASCII-SMALL-LETTER-L} \text{ASCII-SMALL-LETTER-O} \text{ASCII-SMALL-LETTER-R}$$

$$\text{LITERAL-CHAR} = \text{ASCII-REVERSE-SOLIDUS} \text{UTF16-ANY}$$

$$\text{LITERAL-CHAR-REPEAT} = \text{ASCII-ASTERISK} \text{UTF16-ANY}$$

$$\text{LITERAL-STRING} = (\text{ASCII-QUOTATION-MARK} 1 * \text{UTF16-ANY-WITHOUT-QUOTE} \text{ASCII-QUOTATION-MARK}) / 1 * \text{LITERAL-CHAR}$$

$$\text{UTF16-ANY-WITHOUT-QUOTE} = \%x0000-0021 / \%x0023-FFFF$$

$$\text{LITERAL-CHAR-SPACE} = \text{ASCII-LOW-LINE} \text{UTF16-ANY}$$

$$\text{INTL-CHAR-DECIMAL-SEP} = \text{ASCII-FULL-STOP}$$

$$\text{INTL-CHAR-NUMGRP-SEP} = \text{ASCII-COMMA}$$

$$\text{INTL-CHAR-DATE-SEP} = \text{ASCII-SOLIDUS}$$

$$\text{INTL-CHAR-TIME-SEP} = \text{ASCII-COLON}$$

$$\text{INTL-COLOR} = (\text{ASCII-CAPITAL-LETTER-B} \text{ASCII-SMALL-LETTER-L} \text{ASCII-SMALL-LETTER-A} \text{ASCII-SMALL-LETTER-C} \text{ASCII-SMALL-LETTER-K}) / (\text{ASCII-CAPITAL-LETTER-B} \text{ASCII-SMALL-LETTER-L} \text{ASCII-SMALL-LETTER-U} \text{ASCII-SMALL-LETTER-E}) / (\text{ASCII-CAPITAL-LETTER-C} \text{ASCII-SMALL-LETTER-Y} \text{ASCII-SMALL-LETTER-A} \text{ASCII-SMALL-LETTER-N}) / (\text{ASCII-CAPITAL-LETTER-G} \text{ASCII-SMALL-LETTER-R} \text{ASCII-SMALL-LETTER-E} \text{ASCII-SMALL-LETTER-E} \text{ASCII-SMALL-LETTER-N}) / (\text{ASCII-CAPITAL-LETTER-M} \text{ASCII-SMALL-LETTER-A} \text{ASCII-SMALL-LETTER-G} \text{ASCII-SMALL-LETTER-E} \text{ASCII-SMALL-LETTER-N} \text{ASCII-SMALL-LETTER-T} \text{ASCII-SMALL-LETTER-A}) / (\text{ASCII-CAPITAL-LETTER-R} \text{ASCII-SMALL-LETTER-E} \text{ASCII-SMALL-LETTER-D}) / (\text{ASCII-CAPITAL-LETTER-W} \text{ASCII-SMALL-LETTER-H} \text{ASCII-SMALL-LETTER-I} \text{ASCII-SMALL-LETTER-T} \text{ASCII-SMALL-LETTER-E}) / (\text{ASCII-CAPITAL-LETTER-Y} \text{ASCII-SMALL-LETTER-E} \text{ASCII-SMALL-LETTER-L} \text{ASCII-SMALL-LETTER-L} \text{ASCII-SMALL-LETTER-O} \text{ASCII-SMALL-LETTER-W})$$

INTL-NUMFMT-GENERAL = ASCII-CAPITAL-LETTER-G ASCII-SMALL-LETTER-E ASCII-SMALL-LETTER-N ASCII-SMALL-LETTER-E ASCII-SMALL-LETTER-R ASCII-SMALL-LETTER-A ASCII-SMALL-LETTER-L

INTL-AMPM = (ASCII-CAPITAL-LETTER-A ASCII-CAPITAL-LETTER-M ASCII-SOLIDUS ASCII-CAPITAL-LETTER-P ASCII-CAPITAL-LETTER-M) / "A/P"

UTF16-ANY = %x0000-FFFF

ASCII-SPACE = %x20

ASCII-EXCLAMATION-MARK = %x21

ASCII-QUOTATION-MARK = %x22

ASCII-NUMBER-SIGN = %x23

ASCII-DOLLAR-SIGN = %x24

ASCII-PERCENT-SIGN = %x25

ASCII-AMPERSAND = %x26

ASCII-APOSTROPHE = %x27

ASCII-LEFT-PARENTHESIS = %x28

ASCII-RIGHT-PARENTHESIS = %x29

ASCII-ASTERISK = %x2A

ASCII-PLUS-SIGN = %x2B

ASCII-COMMA = %x2C

ASCII-HYPHEN-MINUS = %x2D

ASCII-FULL-STOP = %x2E

ASCII-SOLIDUS = %x2F

ASCII-DIGIT-ZERO = %x30

ASCII-DIGIT-ONE = %x31

ASCII-DIGIT-TWO = %x32

ASCII-DIGIT-THREE = %x33

ASCII-DIGIT-FOUR = %x34

ASCII-DIGIT-FIVE = %x35

ASCII-DIGIT-SIX = %x36

ASCII-DIGIT-SEVEN = %x37

ASCII-DIGIT-EIGHT = %x38

ASCII-DIGIT-NINE = %x39

ASCII-COLON = %x3A
ASCII-SEMICOLON = %x3B
ASCII-LESS-THAN-SIGN = %x3C
ASCII-EQUALS-SIGN = %x3D
ASCII-GREATER-THAN-SIGN = %x3E
ASCII-QUESTION-MARK = %x3F
ASCII-COMMERCIAL-AT = %x40
ASCII-CAPITAL-LETTER-A = %x41
ASCII-CAPITAL-LETTER-B = %x42
ASCII-CAPITAL-LETTER-C = %x43
ASCII-CAPITAL-LETTER-D = %x44
ASCII-CAPITAL-LETTER-E = %x45
ASCII-CAPITAL-LETTER-F = %x46
ASCII-CAPITAL-LETTER-G = %x47
ASCII-CAPITAL-LETTER-H = %x48
ASCII-CAPITAL-LETTER-I = %x49
ASCII-CAPITAL-LETTER-J = %x4A
ASCII-CAPITAL-LETTER-K = %x4B
ASCII-CAPITAL-LETTER-L = %x4C
ASCII-CAPITAL-LETTER-M = %x4D
ASCII-CAPITAL-LETTER-N = %x4E
ASCII-CAPITAL-LETTER-O = %x4F
ASCII-CAPITAL-LETTER-P = %x50
ASCII-CAPITAL-LETTER-Q = %x51
ASCII-CAPITAL-LETTER-R = %x52
ASCII-CAPITAL-LETTER-S = %x53
ASCII-CAPITAL-LETTER-T = %x54
ASCII-CAPITAL-LETTER-U = %x55
ASCII-CAPITAL-LETTER-V = %x56
ASCII-CAPITAL-LETTER-W = %x57

ASCII-CAPITAL-LETTER-X = %x58
ASCII-CAPITAL-LETTER-Y = %x59
ASCII-CAPITAL-LETTER-Z = %x5A
ASCII-LEFT-SQUARE-BRACKET = %x5B
ASCII-REVERSE-SOLIDUS = %x5C
ASCII-RIGHT-SQUARE-BRACKET = %x5D
ASCII-CIRCUMFLEX-ACCENT = %x5E
ASCII-LOW-LINE = %x5F
ASCII-GRAVE-ACCENT = %x60
ASCII-SMALL-LETTER-A = %x61
ASCII-SMALL-LETTER-B = %x62
ASCII-SMALL-LETTER-C = %x63
ASCII-SMALL-LETTER-D = %x64
ASCII-SMALL-LETTER-E = %x65
ASCII-SMALL-LETTER-F = %x66
ASCII-SMALL-LETTER-G = %x67
ASCII-SMALL-LETTER-H = %x68
ASCII-SMALL-LETTER-I = %x69
ASCII-SMALL-LETTER-J = %x6A
ASCII-SMALL-LETTER-K = %x6B
ASCII-SMALL-LETTER-L = %x6C
ASCII-SMALL-LETTER-M = %x6D
ASCII-SMALL-LETTER-N = %x6E
ASCII-SMALL-LETTER-O = %x6F
ASCII-SMALL-LETTER-P = %x70
ASCII-SMALL-LETTER-Q = %x71
ASCII-SMALL-LETTER-R = %x72
ASCII-SMALL-LETTER-S = %x73
ASCII-SMALL-LETTER-T = %x74
ASCII-SMALL-LETTER-U = %x75

```

ASCII-SMALL-LETTER-V = %x76

ASCII-SMALL-LETTER-W = %x77

ASCII-SMALL-LETTER-X = %x78

ASCII-SMALL-LETTER-Y = %x79

ASCII-SMALL-LETTER-Z = %x7A

ASCII-LEFT-CURLY-BRACKET = %x7B

ASCII-VERTICAL-LINE = %x7C

ASCII-RIGHT-CURLY-BRACKET = %x7D

ASCII-TILDE = %x7E

ASCII-DELETE = %x7F

ASCII-CRLF = %x0d.0a

ASCII-DIGIT = ASCII-DIGIT-ZERO / ASCII-DIGIT-ONE / ASCII-DIGIT-TWO / ASCII-DIGIT-THREE / ASCII-
DIGIT-FOUR / ASCII-DIGIT-FIVE / ASCII-DIGIT-SIX / ASCII-DIGIT-SEVEN / ASCII-DIGIT-EIGHT /
ASCII-DIGIT-NINE

ASCII-DIGIT-HEXADECIMAL = ASCII-DIGIT / ASCII-SMALL-LETTER-A / ASCII-SMALL-LETTER-B / ASCII-
SMALL-LETTER-C / ASCII-SMALL-LETTER-D / ASCII-SMALL-LETTER-E / ASCII-SMALL-LETTER-F /
ASCII-CAPITAL-LETTER-A / ASCII-CAPITAL-LETTER-B / ASCII-CAPITAL-LETTER-C / ASCII-CAPITAL-
LETTER-D / ASCII-CAPITAL-LETTER-E / ASCII-CAPITAL-LETTER-F

```

2.4.127 Formula

The **Formula** record specifies a formula (section [2.2.2](#)) for a **cell**.

0	1	2	3	4	5	6	7	8	9	10	11	12	13	14	15	16	17	18	19	20	21	22	23	24	25	26	27	28	29	30	31						
cell																																					
...																val																					
...																																					
...																A	B	C	D	E	F	reserved3															
chn																																					
formula (variable)																																					
...																																					

cell (6 bytes): A [Cell](#) structure that specifies a cell on the **sheet**.

val (8 bytes): A [FormulaValue](#) structure that specifies the value of the formula.

A - fAlwaysCalc (1 bit): A bit that specifies whether the formula needs to be calculated during the next recalculation.

B - reserved1 (1 bit): MUST be zero, and MUST be ignored.

C - fFill (1 bit): A bit that specifies whether the cell has a **fill alignment** or a **center-across-selection alignment**.

Value	Meaning
0	Cell does not have a fill alignment or a center-across-selection alignment.
1	Cell has either a fill alignment or a center-across-selection alignment.

D - fShrFmla (1 bit): A bit that specifies whether the formula is part of a shared formula as defined in [ShrFmla](#). If this formula is part of a shared formula, **formula.rgce** MUST begin with a [PtgExp](#) structure.

E - reserved2 (1 bit): MUST be zero, and MUST be ignored.

F - fClearErrors (1 bit): A bit that specifies whether the formula is excluded from **formula error checking**.

reserved3 (10 bits): MUST be zero, and MUST be ignored.

chn (4 bytes): A field that specifies an application-specific cache of information. This cache exists for performance reasons only, and can be rebuilt based on information stored elsewhere in the file without affecting calculation results.

formula (variable): A [CellParsedFormula](#) structure that specifies the formula.

2.4.128 Frame

The **Frame** record specifies the type, size and position of the frame around a [chart](#) element as defined by the [Chart Sheet Substream ABNF](#). A chart element's frame is specified by the Frame record following it.

0	1	2	3	4	5	6	7	8	9	10	11	12	13	14	15	16	17	18	19	20	21	22	23	24	25	26	27	28	29	30	31
frt																A	B	reserved													

frt (2 bytes): An unsigned integer that specifies the type of frame to be drawn. MUST be a value from the following table:

Value	Frame Type
0x0000	A frame surrounding the chart element.
0x0004	A frame with a shadow surrounding the chart element.

A - fAutoSize (1 bit): A bit that specifies if the size of the frame is automatically calculated. If the value is 1, the size of the frame is automatically calculated. In this case, the width and height specified by the chart element are ignored and the size of the frame is calculated automatically. If the value is 0, the width and height specified by the chart element are used as the size of the frame.

B - fAutoPosition (1 bit): A bit that specifies if the position of the frame is automatically calculated. If the value is 1, the position of the frame is automatically calculated. In this case, the (x, y) specified by the chart element are ignored, and the position of the frame is automatically calculated. If the value is 0, the (x, y) location specified by the chart element are used as the position of the frame.

reserved (14 bits): MUST be zero, and MUST be ignored.

2.4.129 FrtFontList

The **FrntFontList** record specifies **font** information used on the chart and specifies the beginning of a collection of **Font** records as defined by the [Chart Sheet Substream ABNF](#).

0	1	2	3	4	5	6	7	8	9	10	11	12	13	14	15	16	17	18	19	20	1	2	3	4	5	6	7	8	9	30	1
frtHeaderOld																															
verExcel								reserved												cFont											
rgFontInfo (variable)																															
...																															

frtHeaderOld (4 bytes): An [FrntHeaderOld](#) structure. The **frtHeaderOld.rt** field MUST be 0x085A.

verExcel (1 byte): An unsigned integer that specifies the application version where new [chart](#) elements were introduced that use the font information specified by **rgFontInfo**. MUST be a value from the following table and MUST be equal to iObjectInstance1 of the [StartObject](#) record that immediately follows this record as defined by the Chart Sheet Substream ABNF:

Value	Meaning
0x09	This record pertains to new objects introduced in an application version<92>. rgFontInfo specifies the font information that is used by display units labels specified by YMult .
0x0A	This record pertains to new objects introduced in an application version<93>. rgFontInfo specifies the font information that is used by extended data label specified by DataLabExt .

reserved (1 byte): MUST be zero, and MUST be ignored.

cFont (2 bytes): An unsigned integer that specifies the number of items in **rgFontInfo**.

rgFontInfo (variable): An array of [FontInfo](#) structures that specify the font information. The number of elements in this array MUST be equal to the value specified in **cFont**.

2.4.130 FrtWrapper

The **FrntWrapper** record wraps around a non-Future Record Type ([FRT](#)) record and converts it into an FRT record.

0	1	2	3	4	5	6	7	8	9	10	11	12	13	14	15	16	17	18	19	20	21	22	23	24	25	26	27	28	29	30	31
frtHeaderOld																															
wrappedRecord (variable)																															
...																															
frtWrapperPadding (variable)																															
...																															

frtHeaderOld (4 bytes): An [FrtHeaderOld](#) structure. The **frtHeaderOld.rt** MUST be 0x0851.

wrappedRecord (variable): A [Font](#), [Continue](#), [LineFormat](#), [AreaFormat](#), [SeriesText](#), [DefaultText](#), [Text](#), [FontX](#), [ObjectLink](#), [Frame](#), [Begin](#), [End](#), [PicF](#), [Pos](#), [AlRuns](#), [BRAI](#), [Fbi](#), or [GelFrame](#) that specifies the record being wrapped. These records MUST be wrapped in this FrtWrapper if they are part of a collection defined by [StartObject](#) and [EndObject](#). These records appear according to their record name and not as FrtWrapper in the **ABNF** specified in [chart sheet substream](#).

frtWrapperPadding (variable): An array of bytes that is used to pad **FrtWrapper**. Each element MUST be zero and MUST be ignored. This field MUST be present if and only if the size of the **wrappedRecord** is less than 8 bytes. If present, the size of **frtWrapperPadding** MUST be specified by the following formula:

8 bytes – (size of **wrappedRecord**)

The size of the padded **FrtWrapper** MUST be no less than the size of the [FrtHeader](#) structure (12 bytes).

2.4.131 GelFrame

The **GelFrame** record specifies the properties of a **fill pattern** for parts of a [chart](#). The record consists of an OfficeArtFOPT, as specified in [\[MS-ODRAW\]](#) section 2.2.9, and an OfficeArtTertiaryFOPT, as specified in [\[MS-ODRAW\]](#) section 2.2.11, that both contain properties for the fill pattern applied. [<94>](#)

0	1	2	3	4	5	6	7	8	9	10	11	12	13	14	15	16	17	18	19	20	21	22	23	24	25	26	27	28	29	30	31
OPT1 (variable)																															
...																															
OPT2 (variable)																															
...																															

OPT1 (variable): An OfficeArtFOPT, as specified in [\[MS-ODRAW\]](#) section 2.2.9, specifies the primary properties of the fill pattern. MUST only contain the subset of OfficeArtFOPT properties specified in the following list:

- fillType, as specified in [\[MS-ODRAW\]](#) section 2.3.7.1
- fillColor, as specified in [\[MS-ODRAW\]](#) section 2.3.7.2

- fillOpacity, as specified in [MS-ODRAW] section 2.3.7.3
- fillBackColor, as specified in [MS-ODRAW] section 2.3.7.4
- fillBackOpacity, as specified in [MS-ODRAW] section 2.3.7.5
- fillCrMod, as specified in [MS-ODRAW] section 2.3.7.6
- fillBlip_complex, as specified in [MS-ODRAW] section 2.3.7.8
- fillBlipName_complex, as specified in [MS-ODRAW] section 2.3.7.10
- fillBlipFlags, as specified in [MS-ODRAW] section 2.3.7.11
- fillWidth, as specified in [MS-ODRAW] section 2.3.7.12
- fillHeight, as specified in [MS-ODRAW] section 2.3.7.13
- fillAngle, as specified in [MS-ODRAW] section 2.3.7.14
- fillFocus, as specified in [MS-ODRAW] section 2.3.7.15
- fillToLeft, as specified in [MS-ODRAW] section 2.3.7.16
- fillToTop, as specified in [MS-ODRAW] section 2.3.7.17
- fillToRight, as specified in [MS-ODRAW] section 2.3.7.18
- fillToBottom, as specified in [MS-ODRAW] section 2.3.7.19
- fillRectLeft, as specified in [MS-ODRAW] section 2.3.7.20
- fillRectTop, as specified in [MS-ODRAW] section 2.3.7.21
- fillRectRight, as specified in [MS-ODRAW] section 2.3.7.22
- fillRectBottom, as specified in [MS-ODRAW] section 2.3.7.23
- fillDztype, as specified in [MS-ODRAW] section 2.3.7.24
- fillShadePreset, as specified in [MS-ODRAW] section 2.3.7.25
- fillShadeColors_complex, as specified in [MS-ODRAW] section 2.3.7.27
- fillOriginX, as specified in [MS-ODRAW] section 2.3.7.28
- fillOriginY, as specified in [MS-ODRAW] section 2.3.7.29
- fillShapeOriginX, as specified in [MS-ODRAW] section 2.3.7.30
- fillShapeOriginY, as specified in [MS-ODRAW] section 2.3.7.31
- fillShadeType, as specified in [MS-ODRAW] section 2.3.7.32
- fFilled, as specified in [MS-ODRAW] section 2.3.7.43
- fHitTestFill, as specified in [MS-ODRAW] section 2.3.7.43
- fillShape, as specified in [MS-ODRAW] section 2.3.7.43
- fillUseRect, as specified in [MS-ODRAW] section 2.3.7.43
- fNoFillHitTest, as specified in [MS-ODRAW] section 2.3.7.43

OPT2 (variable): An OfficeArtTertiaryFOPT, as specified in [MS-ODRAW] section 2.2.11 specifies the additional properties of the fill pattern. MUST only contain the subset of OfficeArtTertiaryFOPT properties specified in the following list<95>:

- fillColorExt, as specified in [MS-ODRAW] section 2.3.7.33
- fillColorExtMod, as specified in [MS-ODRAW] section 2.3.7.35
- fillBackColorExt, as specified in [MS-ODRAW] section 2.3.7.37
- fillBackColorExtMod, as specified in [MS-ODRAW] section 2.3.7.39
- fRecolorFillAsPicture, as specified in [MS-ODRAW] section 2.3.7.43
- fUseShapeAnchor, as specified in [MS-ODRAW] section 2.3.7.43

2.4.132 GridSet

The **GridSet** record specifies a reserved value.

0	1	2	3	4	5	6	7	8	9	10	11	12	13	14	15	16	17	18	19	20	21	22	23	24	25	26	27	28	29	30	31																
gridset																																															

gridset (2 bytes): Reserved, and MUST be 1.

2.4.133 GUIDTypeLib

The **GUIDTypeLib** record specifies the **GUID** as specified by [MS-DTYP] that uniquely identifies the **type library** of the application that wrote the **Visual Basic for Applications (VBA)** project in the file.

0	1	2	3	4	5	6	7	8	9	10	11	12	13	14	15	16	17	18	19	20	21	22	23	24	25	26	27	28	29	30	31
frtHeader																															
...																															
...																															
guid (16 bytes)																															
...																															
...																															

frtHeader (12 bytes): An [FrtHeader](#) structure. The **frtHeader.rt** field MUST be 0x0897.

guid (16 bytes): A GUID as specified by [MS-DTYP] that uniquely identifies the type library of the application that wrote the VBA project. The value SHOULD <96> be 0x0.

2.4.134 Guts

The **Guts** record specifies the maximum **outline** levels for row and column **gutters**.

0	1	2	3	4	5	6	7	8	9	10	11	12	13	14	15	16	17	18	19	20	21	22	23	24	25	26	27	28	29	30	31
unused1																unused2															
iLevelRwMac																iLevelColMac															

unused1 (2 bytes): Undefined and MUST be ignored.

unused2 (2 bytes): Undefined and MUST be ignored.

iLevelRwMac (2 bytes): An unsigned integer that specifies the maximum **outline level** for the row gutter. The value MUST be one of the values specified in the following table.

iLevelColMac (2 bytes): An unsigned integer that specifies the maximum outline level for the column gutter. The value MUST be one of the values specified in the following table.

Value	Maximum outline level
0x0000	0
0x0002	1
0x0003	2
0x0004	3
0x0005	4
0x0006	5
0x0007	6
0x0008	7

2.4.135 HCenter

The **HCenter** record specifies whether the **sheet** is to be centered horizontally when printed.

0	1	2	3	4	5	6	7	8	9	10	11	12	13	14	15	16	17	18	19	20	21	22	23	24	25	26	27	28	29	30	31
hcenter																															

hcenter (2 bytes): A Boolean (section [2.5.14](#)) that specifies whether the sheet is to be centered between [LeftMargin](#) and [RightMargin](#) when printed.

2.4.136 Header

The **Header** record specifies the header text of the current **sheet** when printed.

0	1	2	3	4	5	6	7	8	9	10	11	12	13	14	15	16	17	18	19	20	21	22	23	24	25	26	27	28	29	30	31
ast (variable)																															

...

ast (variable): An [XLUnicodeString](#) structure that specifies the header text for the current sheet. It is optional and exists only if the record size is not zero. The text appears at the top of every page when printed. The length of the text MUST be less than or equal to 255. The header text can contain special commands, for example a **placeholder** for the page number, current date or text formatting attributes. Special commands are represented by single letter with a leading ampersand ("&"). The following **ABNF** lists the possible commands and how they are used:

ABNF Grammar for Header and Footer Strings

```
headerfooter = *(left / pagenum / pagetotal / fontsize / strikethrough / superscript / subscript  
/ center / date / time / filepath / picture / underline / doubleunderline / right /  
bookpath / sheetname / fontname / fonttype / font / bold / italic / ampersand /  
emptytoken / UNICHAR)
```

```
UNICHAR = %x0020-FFFF
```

This code specifies **Unicode** characters, starting with the space character (%x0020).

```
DIGIT = %x0030-0039
```

This code specifies a digit between 0 and 9.

```
HEXALPHA = %x0041-0046 / %x0061-0066
```

This code specifies a character between A and F or between a and f.

```
DQUOTE = %x0022
```

This code specifies a double quotation mark.

```
left = "&L"
```

This code specifies the beginning of the left section. There are three header and footer sections: left, center, and right. When two or more of this section marker exist, the contents from all markers are concatenated, in the order of appearance, and placed into the left section.

```
pagenum = "&P"
```

This code specifies the current page number.

```
pagetotal = "&N" 0*1(("-" / "+") *DIGIT)
```

This code specifies the total number of pages.

```
fontsize = "&" 1*3DIGIT
```

This code specifies the text **font** size, where font size is measured in points.

```
strikethrough = "&S"
```

This code specifies whether the strikethrough **text style** is on or off. The first occurrence of this code **MUST** turn the strikethrough text style on, and the second occurrence **MUST** turn it off.

```
superscript = "&X"
```

This code specifies whether the superscript text style is on or off. The first occurrence of this code **MUST** turn the superscript text style on, and the second occurrence **MUST** turn it off. The superscript and subscript codes **MUST NOT** both be on at same time. If both codes occur in the string, the code that occurs first is applied and the other is ignored.

```
subscript = "&Y"
```

This code specifies whether the subscript text style is on or off. The first occurrence of this code **MUST** turn the subscript text style on, and the second occurrence **MUST** turn it off. The superscript and subscript codes **MUST NOT** both be on at same time. If both codes occur in the string, the code that occurs first is applied and the other is ignored.

```
center = "&C"
```

This code specifies the beginning of the center section. When two or more of this section marker exist, the contents from all markers are concatenated, in the order of appearance, and placed into the center section.

```
date = "&D"
```

This code specifies a date.

```
time = "&T"
```

This code specifies a time.

```
picture = "&G"
```

This code specifies a picture.

```
underline = "&U"
```

This code specifies whether the single underline text style is on or off. The first occurrence of this code **MUST** turn the underline text style on, and the second occurrence **MUST** turn it off.

```
doubleunderline = "&E"
```

This code specifies whether the double underline text style is on or off. The first occurrence of this code MUST turn the double underline text style on, and the second occurrence MUST turn it off.

```
right = "&R"
```

This code specifies the beginning of the right section. When two or more of this section marker exist, the contents from all markers are concatenated, in the order of appearance, and placed into the right section.

```
bookpath = "&Z"
```

This code specifies a **workbook** file path.

```
bookname = "&F"
```

This code specifies a workbook file name.

```
sheetname = "&A"
```

This code specifies a sheet name.

```
fontname = (1*UNICHAR / "-")
```

This code specifies the text font name. When the font name is a hyphen, no font is specified. This can be a localized string.

```
fonttype = ("italic" / "bold" / "regular" / "italic bold" / "bold italic")
```

This code specifies the text font type. This can be a localized string.

```
font = "&" DQUOTE fontname , fonttype DQUOTE
```

This code specifies the text font.

```
bold = "&B"
```

This code specifies whether the bold text style is on or off. The first occurrence of this code MUST turn the bold text style on, and the second occurrence MUST turn it off.

```
italic = "&I"
```

This code specifies whether the italic text style is on or off. The first occurrence of this code MUST turn the italic text style on, and the second occurrence MUST turn it off.

```
ampersand = "&&"
```

This code specifies an ampersand character.

```
emptytoken = "&" *1UNICHAR
```

This code specifies an unidentified token. If just "&" appears, or if there is a UNICHAR specified after "&" and it is not one of the UNICHAR characters listed in the preceding rules, then the token is interpreted as empty and nothing is rendered in the header or footer text.

2.4.137 HeaderFooter

The **HeaderFooter** record specifies the even page header and footer text, and the first page header and footer text of the current **sheet**.

0	1	2	3	4	5	6	7	8	9	10	11	12	13	14	15	16	17	18	19	20	21	22	23	24	25	26	27	28	29	30	31
frtHeader																															
...																															
...																															
guidSView (16 bytes, optional)																															
...																															
...																															
A	B	C	D	unused																cchHeaderEven											
cchFooterEven																cchHeaderFirst															
cchFooterFirst																strHeaderEven (variable)															
...																															
strFooterEven (variable)																															
...																															
strHeaderFirst (variable)																															
...																															
strFooterFirst (variable)																															
...																															

frtHeader (12 bytes): An [FrtHeader](#) structure. The **frtHeader.rt** field MUST be 0x089C.

guidSView (16 bytes): A **GUID** as specified by [\[MS-DTYP\]](#) that specifies the current **sheet view**. If it is zero it means the current sheet. Otherwise, this field **MUST** match the **guid** field of the preceding [UserSViewBegin](#) record.

A - fHFDiffOddEven (1 bit): A bit that specifies whether the odd and even pages use a different header and footer. If the value is 1, the [Header](#) and [Footer](#) records specify the odd page header and footer, and **strHeaderEven** and **strFooterEven** specify the even page header and footer.

B - fHFDiffFirst (1 bit): A bit that specifies whether the first page uses a different header and footer from the rest of the pages. If the value is 1, the [Header](#) and [Footer](#) records specify the header and footer of the rest of the pages, and **strHeaderFirst** and **strFooterFirst** specify the first page header and footer.

C - fHFScaleWithDoc (1 bit): A bit that specifies whether the header and footer is scaled with the sheet.

D - fHFAlignMargins (1 bit): A bit that specifies whether the left and right edges of the header and footer are lined up with the left and right margins of the sheet.

unused (12 bits): Undefined, and **MUST** be ignored.

cchHeaderEven (2 bytes): An unsigned integer that specifies the number of characters in **strHeaderEven**. **MUST** be less than or equal to 255. The value **MUST** be zero if **fHFDiffOddEven** is zero.

cchFooterEven (2 bytes): An unsigned integer that specifies the number of characters in **strFooterEven**. **MUST** be less than or equal to 255. The value **MUST** be zero if **fHFDiffOddEven** is zero.

cchHeaderFirst (2 bytes): An unsigned integer that specifies the number of characters in **strHeaderFirst**. **MUST** be less than or equal to 255. The value **MUST** be zero if **fHFDiffFirst** is zero.

cchFooterFirst (2 bytes): An unsigned integer that specifies the number of characters in **strFooterFirst**. **MUST** be less than or equal to 255. The value **MUST** be zero if **fHFDiffFirst** is zero.

strHeaderEven (variable): An [XLUnicodeString](#) structure that specifies the header text on the even pages. The number of characters in the string **MUST** be equal to **cchHeaderEven**. The string can contain special commands, for example a **placeholder** for the page number, current date or text formatting attributes. Refer to [Header](#) for more details about the string format.

strFooterEven (variable): An [XLUnicodeString](#) structure that specifies the footer text on the even pages. The number of characters in the string **MUST** be equal to **cchFooterEven**. The string can contain special commands, for example a placeholder for the page number, current date or text formatting attributes. Refer to [Header](#) for more details about the string format.

strHeaderFirst (variable): An [XLUnicodeString](#) structure that specifies the header text on the first page. The number of characters in the string **MUST** be equal to **cchHeaderFirst**. The string can contain special commands, for example a placeholder for the page number, current date or text formatting attributes. Refer to [Header](#) for more details about the string format.

strFooterFirst (variable): An [XLUnicodeString](#) structure that specifies the footer text on the first page. The number of characters in the string **MUST** be equal to **cchFooterFirst**. The string can contain special commands, for example a placeholder for the page number, current date or text formatting attributes. Refer to [Header](#) for more details about the string format.

2.4.138 HFPicture

The **HFPicture** record specifies a picture used by a **sheet** header or footer. The picture MUST be specified in either an **OfficeArtDgContainer** or **OfficeArtDggContainer** record as specified in [MS-ODRAW]. The picture can be continued across multiple HFPicture records. The **OfficeArtClientAnchor** structure mentioned in [MS-ODRAW] refers to [OfficeArtClientAnchorHF](#).

0	1	2	3	4	5	6	7	8	9	10	11	12	13	14	15	16	17	18	19	20	21	22	23	24	25	26	27	28	29	30	31
frtHeader																															
...																															
...																															
A	B	C	unused					reserved					rgDrawing (variable)																		
...																															

frtHeader (12 bytes): An [FrHeader](#) structure. The **frtHeader.rt** field MUST be 0x0866.

A - fIsDrawing (1 bit): A bit that specifies whether **rgDrawing** is an **OfficeArtDgContainer** record as specified in [MS-ODRAW]. MUST be a value from the following table:

Value	Meaning
0	rgDrawing is an OfficeArtDggContainer record as specified in [MS-ODRAW] and fIsDrawingGroup MUST be 1.
1	rgDrawing is an OfficeArtDgContainer record as specified in [MS-ODRAW] and fIsDrawingGroup MUST be 0.

B - fIsDrawingGroup (1 bit): A bit that specifies whether **rgDrawing** is an **OfficeArtDggContainer** record as specified in [MS-ODRAW]. MUST be a value from the following table:

Value	Meaning
0	rgDrawing is an OfficeArtDgContainer record as specified in [MS-ODRAW] and fIsDrawing MUST be 1.
1	rgDrawing is an OfficeArtDggContainer record as specified in [MS-ODRAW] and fIsDrawing MUST be 0.

C - fContinue (1 bit): A bit that specifies whether this record is continuing the previous HFPicture record. The value 0 means it is the first HFPicture record.

unused (5 bits): Undefined and MUST be ignored.

reserved (1 byte): MUST be zero, and MUST be ignored.

rgDrawing (variable): The meaning of this field is specified in the following table.

Value of fIsDrawing	Meaning of rgDrawing
0	This is an OfficeArtDggContainer as

Value of fIsDrawing	Meaning of rgDrawing
	specified in [MS-ODRAW] that specifies the drawing group of this picture.
1	This is an OfficeArtDgContainer as specified in [MS-ODRAW] that specifies the drawing object of this picture

2.4.139 HideObj

The **HideObj** record specifies how **ActiveX objects**, **OLE objects**, and **drawing objects** appear in a window that contains the **workbook**.

0	1	2	3	4	5	6	7	8	9	10	1	2	3	4	5	6	7	8	9	20	1	2	3	4	5	6	7	8	9	30	1
hideObj																															

hideObj (2 bytes): A **HideObjEnum** enumeration that specifies how ActiveX objects, OLE objects, and drawing objects appear in a window that contains the workbook.

2.4.140 HLink

The **HLink** record specifies a **hyperlink** associated with a **range of cells**.

0	1	2	3	4	5	6	7	8	9	10	1	2	3	4	5	6	7	8	9	20	1	2	3	4	5	6	7	8	9	30	1
ref8																															
...																															
hlinkClsid (16 bytes)																															
...																															
...																															
hyperlink (variable)																															
...																															

ref8 (8 bytes): A **Ref8U** structure that specifies the range of cells containing the hyperlink.

hlinkClsid (16 bytes): A **class identifier (CLSID)** that specifies the **COM** component which saved the Hyperlink Object (as defined by **[MS-OSHARED]** section 2.3.7.1) in **hyperlink**.

hyperlink (variable): A Hyperlink Object (as defined by **[MS-OSHARED]** section 2.3.7.1) that specifies the hyperlink and hyperlink-related information.

2.4.141 HLinkTooltip

The **HLinkTooltip** record specifies the **hyperlink ToolTip** associated with a **range** of cells.

0	1	2	3	4	5	6	7	8	9	10	11	12	13	14	15	16	17	18	19	20	21	22	23	24	25	26	27	28	29	30	31
frtRefHeaderNoGrbit																															
...																															
...																wzTooltip (variable)															
...																															

frtRefHeaderNoGrbit (10 bytes): An [FrtRefHeaderNoGrbit](#) structure. The **frtRefHeaderNoGrbit.rt** field MUST be 0x0800. The **frtRefHeaderNoGrbit.ref8** field MUST match a [Ref8U](#) field from an existing [HLink](#) record.

wzTooltip (variable): An array of **Unicode** characters that specifies the ToolTip string. String length MUST be greater than or equal to 2 and less than or equal to 256 (inclusive of null terminator) and the string MUST be null-terminated.

2.4.142 HorizontalPageBreaks

The **HorizontalPageBreaks** record specifies a list of explicit row **page breaks**.

0	1	2	3	4	5	6	7	8	9	10	11	12	13	14	15	16	17	18	19	20	21	22	23	24	25	26	27	28	29	30	31
cbrk																rgbrk (variable)															
...																															

cbrk (2 bytes): An unsigned integer that specifies the number of page breaks. The value MUST be less than or equal to 1026.

rgbrk (variable): An array of [HorzBrk](#) structure that specifies all of the page breaks. The array MUST be sorted first by **rgbrk.row**, and then by **rgbrk.ColStart**. Two page breaks MUST NOT overlap. The number of **HorzBrk** structures MUST equal the value of **cbrk**.

2.4.143 IFmtRecord

The **IFmtRecord** record specifies the **number format** to use for the text on an [axis](#).

0	1	2	3	4	5	6	7	8	9	10	11	12	13	14	15	16	17	18	19	20	21	22	23	24	25	26	27	28	29	30	31
ifmt																															

ifmt (2 bytes): An [IFmt](#) structure that specifies the number format identifier.

2.4.144 Index

The **Index** record specifies row information and the file locations for all [DBCell](#) records corresponding to each row block in the **sheet**. This record, combined with the DBCell records, is used to optimize the [lookup of cells](#) in a [cell table](#).

0	1	2	3	4	5	6	7	8	9	10	11	12	13	14	15	16	17	18	19	20	21	22	23	24	25	26	27	28	29	30	31
reserved																															
rwMic																															
rwMac																															
ibXF																															
rgibRw (variable)																															
...																															

reserved (4 bytes): MUST be zero, and MUST be ignored.

rwMic (4 bytes): A [RwLongU](#) structure that specifies the first row that has at least one **cell** with data in current sheet. MUST be 0 if there are no rows that have at least one cell with data.

rwMac (4 bytes): An unsigned integer that specifies one plus the zero-based index of the last row that has at least one cell with data in the sheet. MUST be 0 if there are no rows that have at least one cell with data. If not 0, MUST be greater than **rwMic**.

ibXF (4 bytes): A FilePointer as specified in [\[MS-OSHARED\]](#) section 2.2.1.5 that specifies the file position of the [DefColWidth](#) record in the current sheet.

rgibRw (variable): An array of FilePointer. Each FilePointer as specified in [\[MS-OSHARED\]](#) section 2.2.1.5 specifies the file position of each referenced DBCell record. If the positions of DBCell records are not correct, there is no optimized method to do cell lookup and this can cause performance issues. The number of elements in the array MUST be equal to the number of row blocks in this sheet.

2.4.145 InterfaceEnd

The **InterfaceEnd** record specifies the end of a collection of records as defined by the [Globals Substream ABNF](#). The collection of records specifies information about the user interface.

2.4.146 InterfaceHdr

The **InterfaceHdr** record specifies the **code page** of the user interface and specifies the beginning of a collection of records as defined by the [Globals Substream ABNF](#). The collection of records specifies information about the user interface.

0	1	2	3	4	5	6	7	8	9	10	11	12	13	14	15	16	17	18	19	20	21	22	23	24	25	26	27	28	29	30	31
codePage																															

codePage (2 bytes): An unsigned integer that specifies the code page.

MUST be 0x04B0, which specifies **Unicode**.

2.4.147 Intl

The **Intl** record specifies that the **macro sheet** is an **international macro sheet**.

0	1	2	3	4	5	6	7	8	9	10	11	12	13	14	15	16	17	18	19	20	21	22	23	24	25	26	27	28	29	30	31
reserved																															

reserved (2 bytes): MUST be zero, and MUST be ignored.

2.4.148 Label

The **Label** record specifies a label on the **category (2) axis** for each **series**.

0	1	2	3	4	5	6	7	8	9	10	11	12	13	14	15	16	17	18	19	20	21	22	23	24	25	26	27	28	29	30	31
cell																															
...																st (variable)															
...																															

cell (6 bytes): A **Cell** structure that specifies the row and column of the label and the index of the label's format.

st (variable): A **XLUncodeString** structure that contains the text of the label.

2.4.149 LabelSst

The **LabelSst** record specifies a **cell** that contains a string.

0	1	2	3	4	5	6	7	8	9	10	11	12	13	14	15	16	17	18	19	20	21	22	23	24	25	26	27	28	29	30	31
cell																															
...																isst															
...																															

cell (6 bytes): A **Cell** structure that specifies the cell containing the string from the shared string table.

isst (4 bytes): An unsigned integer that specifies the zero-based index of an element in the array of **XLUncodeRichExtendedString** structure in the **rgb** field of the **SST** record in this **Workbook Stream ABNF** that specifies the string contained in the cell. MUST be greater than or equal to zero and less than the number of elements in the **rgb** field of the SST record.

2.4.150 Lbl

The **Lbl** record specifies a **defined name**.

0	1	2	3	4	5	6	7	8	9	10	11	12	13	14	15	16	17	18	19	20	21	22	23	24	25	26	27	28	29	30	31
A	B	C	D	E	F	fGrp						G	H	I	J	chKey						cch									
cce												reserved3																			
itab												reserved4						reserved5													
reserved6						reserved7						Name (variable)																			
...																															
rgce (variable)																															
...																															

A - fHidden (1 bit): A bit that specifies whether the defined name is not **visible** in the list of defined names.

B - fFunc (1 bit): A bit that specifies whether the defined name represents an **Excel macro (XLM)**. If this bit is 1, **fProc** MUST also be 1.

C - fOB (1 bit): A bit that specifies whether the defined name represents a **Visual Basic for Applications (VBA) macro**. If this bit is 1, the **fProc** MUST also be 1.

D - fProc (1 bit): A bit that specifies whether the defined name represents a macro.

E - fCalcExp (1 bit): A bit that specifies whether **rgce** contains a call to a function that can return an array.

F - fBuiltin (1 bit): A bit that specifies whether the defined name represents a **built-in name**.

fGrp (6 bits): An unsigned integer that specifies the **function category** for the defined name. MUST be less than or equal to 31. The values 17 to 31 are user-defined. User-defined values are specified in the [FnGroupName](#) record. The values 0 to 16 are defined as specified in the following table:

Value	Category
0	All
1	Financial
2	Date Time
3	Math Trigonometry
4	Statistical
5	Lookup
6	Database
7	Text

Value	Category
8	Logical
9	Info
10	Commands
11	Customize
12	Macro Control
13	DDE External
14	User Defined
15	Engineering
16	Cube

G - reserved1 (1 bit): MUST be zero, and MUST be ignored.

H - fPublished (1 bit): A bit that specifies whether the defined name is **published**. This bit is ignored if the **fPublishedBookItems** field of the [BookExt_Conditional12](#) structure is 0.

I - fWorkbookParam (1 bit): A bit that specifies whether the defined name is a **workbook** parameter.

J - reserved2 (1 bit): MUST be zero, and MUST be ignored.

chKey (1 byte): The unsigned integer value of the **ASCII** character that specifies the shortcut key for the macro represented by the defined name. MUST be 0 (no shortcut key) if **fFunc** is 1 or if **fProc** is 0. Otherwise MUST [<97>](#) be greater than or equal to 0x41 and less than or equal to 0x5A, or greater than or equal to 0x61 and less than or equal to 0x7A.

cch (1 byte): An unsigned integer that specifies the number of characters in **Name**. MUST be greater than or equal to zero.

cce (2 bytes): An unsigned integer that specifies length of **rgce** in bytes.

reserved3 (2 bytes): MUST be zero, and MUST be ignored.

itab (2 bytes): An unsigned integer that specifies if the defined name is a **local name**, and if so, which **sheet** it is on. If **itab** is not 0, the defined name is a local name and the value MUST be a one-based index to the collection of [BoundSheet8](#) records as they appear in the Globals Substream.

reserved4 (1 byte): MUST be zero, and MUST be ignored.

reserved5 (1 byte): MUST be zero, and MUST be ignored.

reserved6 (1 byte): MUST be zero, and MUST be ignored.

reserved7 (1 byte): MUST be zero, and MUST be ignored.

Name (variable): An [XLUnicodeStringNoCch](#) structure that specifies the name for the defined name. If **fBuiltin** is 0, this field MUST satisfy the same restrictions as the **name** field of the [XLNameUnicodeString](#) structure. If **fBuiltin** is 1, this field is for a built-in name. Each built-in name has a zero-based index value associated with it. A built-in name or its index value MUST be used for this field. The built-in names are defined in the following table:

Values	Names
0x00	Consolidate_Area
0x01	Auto_Open
0x02	Auto_Close
0x03	Extract
0x04	Database
0x05	Criteria
0x06	Print_Area
0x07	Print_Titles
0x08	Recorder
0x09	Data_Form
0x0A	Auto_Activate
0x0B	Auto_Deactivate
0x0C	Sheet_Title
0x0D	_FilterDatabase

rgce (variable): A [NameParsedFormula](#) structure that specifies the **formula** for the **defined name**.

2.4.151 LeftMargin

The **LeftMargin** record specifies the left margin of the current **sheet**.

0	1	2	3	4	5	6	7	8	9	10	11	12	13	14	15	16	17	18	19	20	21	22	23	24	25	26	27	28	29	30	31
num																															
...																															

num (8 bytes): An Xnum (section [2.5.342](#)) value that specifies the left margin of the current sheet in inches. The value MUST be greater than or equal to 0 and less than or equal to 49.

2.4.152 Legend

The **Legend** record specifies properties of a [legend](#), and specifies the beginning of a collection of records defined by [Chart Sheet Substream ABNF](#). The collection of records specifies a legend. The absence of this collection of records implies that a legend does not exist on the [chart](#).

0	1	2	3	4	5	6	7	8	9	10	11	12	13	14	15	16	17	18	19	20	21	22	23	24	25	26	27	28	29	30	31
x																															
y																															

dx								
dy								
unused	wSpace	A	B	C	D	E	F	reserved2

x (4 bytes): An unsigned integer that specifies the x-position, in [SPRC](#), of the upper-left corner of the **bounding rectangle** of the legend. MUST be ignored and the **x1** field from the following [Pos](#) record MUST be used instead.

y (4 bytes): An unsigned integer that specifies the y-position, in [SPRC](#), of the upper-left corner of the bounding rectangle of the legend. MUST be ignored and the **y1** field from the following [Pos](#) record MUST be used instead.

dx (4 bytes): An unsigned integer that specifies the width, in [SPRC](#), of the bounding rectangle of the legend. MUST be ignored and the **x2** field from the following [Pos](#) record MUST be used instead.

dy (4 bytes): An unsigned integer that specifies the height, in [SPRC](#), of the bounding rectangle of the legend. MUST be ignored and the **y2** field from the following [Pos](#) record MUST be used instead.

unused (1 byte): Undefined and MUST be ignored.

wSpace (1 byte): An unsigned integer that specifies the space between **legend entries**. MUST be 0x01, which represents 40 **twips** between legend entries.

A - fAutoPosition (1 bit): A bit that specifies whether the legend is automatically positioned. If this field is 0x1, then **fAutoPosX** MUST be 0x1 and **fAutoPosY** MUST be 0x1.

B - reserved1 (1 bit): MUST be 1, and MUST be ignored.

C - fAutoPosX (1 bit): A bit that specifies whether the x-positioning of the legend is automatic.

D - fAutoPosY (1 bit): A bit that specifies whether the y-positioning of the legend is automatic.

E - fVert (1 bit): A bit that specifies the layout of the legend entries. MUST equal 0x1 if **fWasDataTable** is equal to 0x1. MUST be a value from the following table:

Value	Meaning
0x0	The legend contains multiple columns of legend entries, or the size of the legend was manually changed from the default size.
0x1	The legend contains a single column of legend entries.

F - fWasDataTable (1 bit): A bit that specifies whether the legend is shown in a [data table](#).

reserved2 (10 bits): MUST be zero, and MUST be ignored.

2.4.153 LegendException

The **LegendException** record specifies information about a **legend entry** which was changed from the default legend entry settings, and specifies the beginning of a collection of records as defined by the [Chart Sheet Substream ABNF](#). The collection of records specifies legend entry formatting. On a

[chart](#) where the [legend](#) contains legend entries for the [series](#) and [trendlines](#), as defined in the legend overview, there MUST be zero instances or one instance of this record in the sequence of records that conform to the SERIESFORMAT rule.

0	1	2	3	4	5	6	7	8	9	10	11	12	13	14	15	16	17	18	19	20	21	22	23	24	25	26	27	28	29	30	31
iss																A	B	reserved													

iss (2 bytes): An unsigned integer that specifies the legend entry. This field has different interpretations depending on the content of the legend in the chart. The legend overview specifies the types of content the legend can contain, as follows:

- In a chart where the legend contains legend entries for the series and trendlines, this field MUST be 0xFFFF. This record specifies the legend entry of the series or trendline that contains this record.
- In a chart where the legend contains legend entries for each [data point](#) in the chart, this field specifies the zero-based index of a legend entry in the legend, where 0x0000 is the legend entry for the first data point in the series.
- In a chart with a surface [chart group](#), this field specifies the zero-based index of a legend entry in the legend, where 0x0000 is the legend entry for the lowest band of the surface chart group.

A - fDeleted (1 bit): A bit that specifies whether the legend entry specified by **iss** was deleted.

B - fLabel (1 bit): A bit that specifies whether the legend entry specified by **iss** was formatted. If this field is 1, there MUST be a sequence of records that conform to the ATTACHEDLABEL rule in the Chart Sheet Substream ABNF following this record.

reserved (14 bits): MUST be zero, and MUST be ignored.

2.4.154 Lel

The **Lel** record specifies that a **natural language formula** was lost because of the deletion of a supporting label [<98>](#).

0	1	2	3	4	5	6	7	8	9	10	11	12	13	14	15	16	17	18	19	20	21	22	23	24	25	26	27	28	29	30	31
stFormulaName (variable)																															
...																															

stFormulaName (variable): An [XLUnicodeString](#) structure that specifies the name of the deleted label. The number of characters MUST be less than 252.

2.4.155 Line

The **Line** record specifies that the [chart group](#) is a line chart group, and specifies the chart group attributes.

0	1	2	3	4	5	6	7	8	9	10	11	12	13	14	15	16	17	18	19	20	21	22	23	24	25	26	27	28	29	30	31
A	B	C	reserved																												

A - fStacked (1 bit): A bit that specifies whether the [data points](#) in the chart group that share the same **category (2)** are stacked.

B - f100 (1 bit): A bit that specifies whether the data points in the chart group are displayed as a percentage of the sum of all data points in the chart group that share the same category (2). MUST be 0 if **fStacked** is 0.

C - fHasShadow (1 bit): A bit that specifies whether one or more **data markers** in the chart group has shadows.

reserved (13 bits): MUST be zero, and MUST be ignored.

2.4.156 LineFormat

The **LineFormat** record specifies the appearance of a line.

0	1	2	3	4	5	6	7	8	9	10	11	12	13	14	15	16	17	18	19	20	21	22	23	24	25	26	27	28	29	30	31
rgb																															
Ins																we															
A	B	C	D	reserved2														icv													

rgb (4 bytes): A [LongRGB](#) structure that specifies the color of the line. The color MUST match the color specified by **icv**.

Ins (2 bytes): An unsigned integer that specifies the **style** of the line. MUST be a value from the following table:

Value	Meaning
0x0000	Solid
0x0001	Dash
0x0002	Dot
0x0003	Dash-dot
0x0004	Dash dot-dot
0x0005	None
0x0006	Dark gray pattern
0x0007	Medium gray pattern
0x0008	Light gray pattern

When the value of this field is 0x0005 (None), the values of **we** and **icv** MUST be set to the values specified in the following table:

Attribute	Default Value
Line thickness (we)	0xFFFF (Hairline)
Line color (icv)	0x004D

we (2 bytes): A signed integer that specifies the thickness of the line. MUST be a value from the following table:

Value	Meaning
0xFFFF (-1)	Hairline
0x0000	Narrow (single)
0x0001	Medium (double)
0x0002	Wide (triple)

A - fAuto (1 bit): A bit that specifies whether the line has default formatting.

If the value of **fAuto** is 0, the line has formatting as specified by **lns**, **we**, and **icv**.

If the value of **fAuto** is 1, **lns**, **we**, **icv**, and **rgb** MUST be ignored and default values are used as specified in the following table:

Attribute	Default Value
Line pattern (lns)	0xFFFF (Hairline)
Line thickness (we)	0x0000 (Narrow)
Line color (icv)	0x004D
Line color (rgb)	Match the default color used for icv

B - reserved1 (1 bit): MUST be zero, and MUST be ignored.

C - fAxisOn (1 bit): A bit that specifies whether the [axis](#) line is displayed.

If the previous record is [AxisLine](#) and the value of the **id** field of the AxisLine record is equal to 0x0000, this field MUST be a value from the following table:

fAxisOn	lns	Meaning
0	0x0005	The axis line is not displayed.
0	Any legal value except 0x0005	The axis line is displayed.
1	Any legal value	The axis line is displayed.

If the previous record is not AxisLine and the value of the **id** field of the AxisLine record is equal to 0x0000, this field MUST be zero, and MUST be ignored.

D - fAutoCo (1 bit): A bit that specifies whether **icv** is equal to 0x004D. If the value is 1, **icv** MUST equal 0x004D. If the value is 0, **icv** MUST NOT equal 0x004D.

reserved2 (12 bits): MUST be zero, and MUST be ignored.

icv (2 bytes): An [IcvChart](#) structure that specifies the color of the line. The color MUST match the color specified by **rgb**.

2.4.157 List12

The **List12** record specifies the additional formatting information for a **table**. These records immediately follow a [Feature11](#) or [Feature12](#) record, and specify additional formatting information for the table specified by the Feature11 or Feature12 record. This record is a [future record type](#) record.

0	1	2	3	4	5	6	7	8	9	10	11	12	13	14	15	16	17	18	19	20	21	22	23	24	25	26	27	28	29	30	31
frtHeader																															
...																															
...																															
lsd																idList															
...																rgb (variable)															
...																															

frtHeader (12 bytes): An [FrtHeader](#) structure. The **frtHeader.rt** field MUST be 0x0877.

lsd (2 bytes): An unsigned integer that specifies the type of data contained in the **rgb** field.
MUST be a value specified in the table listed under **rgb**.

idList (4 bytes): An unsigned integer that identifies the associated table for which this record specifies additional formatting. MUST NOT be zero. MUST be equal to the **idList** field of the [TableFeatureType](#) structure embedded in the associated Feature11 or Feature12 record.

rgb (variable): A structure whose type and meaning are specified by the value of **lsd**, as specified in the following table:

Value of lsd	Meaning of rgb
0x0000	rgb is a List12BlockLevel structure that specifies the table block-level formatting .
0x0001	rgb is a List12TableStyleClientInfo structure that specifies the table style .
0x0002	rgb is a List12DisplayName structure that specifies the display name.

2.4.158 LPr

The **LPr** record specifies a record that is unused.

0	1	2	3	4	5	6	7	8	9	10	11	12	13	14	15	16	17	18	19	20	21	22	23	24	25	26	27	28	29	30	31
A	B	C	reserved													unused4															
unused5																unused6															
unused7																unused8															
unused9 (variable)																															
...																															

A - unused1 (1 bit): Undefined and MUST be ignored.

- B - unused2 (1 bit):** Undefined and MUST be ignored.
- C - unused3 (1 bit):** Undefined and MUST be ignored.
- reserved (13 bits):** MUST be zero, and MUST be ignored.
- unused4 (2 bytes):** Undefined and MUST be ignored.
- unused5 (2 bytes):** Undefined and MUST be ignored.
- unused6 (2 bytes):** Undefined and MUST be ignored.
- unused7 (2 bytes):** Undefined and MUST be ignored.
- unused8 (2 bytes):** Undefined and MUST be ignored.
- unused9 (variable):** Undefined and MUST be ignored.

2.4.159 LRng

The **LRng** record specifies a label **range** for **natural language formulas**[<99>](#).

0	1	2	3	4	5	6	7	8	9	10	11	12	13	14	15	16	17	18	19	20	21	22	23	24	25	26	27	28	29	30	31		
crefRw																refRow (variable)																	
...																																	
crefCol																refCol (variable)																	
...																																	

crefRw (2 bytes): An unsigned integer that specifies the number of row label ranges. When added to the value of **crefCol**, the value MUST be less than 1028.

refRow (variable): An array of [Ref8U](#) structures. The array specifies the row label ranges. The size of the array is specified by **crefRw**.

crefCol (2 bytes): An unsigned integer that specifies the number of column label ranges. When added to the value of **crefRw**, the value MUST be less than 1028.

refCol (variable): An array of [Ref8U](#) structures. The array specifies the column label ranges. The size of the array is specified by **crefCol**.

2.4.160 MarkerFormat

The **MarkerFormat** record specifies the color, size, and shape of the associated **data markers** that appear on line, radar, and scatter [chart groups](#). The associated data markers are specified by the preceding [DataFormat](#) record. If this record is not present in the sequence of records that conforms to the [SS](#) rule of the Chart Sheet Substream **ABNF**, then the color, size, and shape of the associated data markers are specified by the default values of the fields of this record.

0	1	2	3	4	5	6	7	8	9	10	11	12	13	14	15	16	17	18	19	20	21	22	23	24	25	26	27	28	29	30	31		
rgbFore																																	

rgbBack					
imk	A	B	C	D	reserved2
icvFore	icvBack				
miSize					

rgbFore (4 bytes): A [LongRGB](#) structure that specifies the **border** color of the data marker. The color **MUST** match the color specified by **icvFore**. The default value of this field is automatically selected from the next available color in the [chart](#) color table.

rgbBack (4 bytes): A LongRGB structure that specifies the interior color of the data marker. The color **MUST** match the color specified by **icvBack**. The default value of this field is the same as the default value for **rgbFore** only when the default **imk** is 0x0001, 0x0002, 0x0003, or 0x0008. Otherwise, the default value is 0xFFFFFFFF.

imk (2 bytes): An unsigned integer that specifies the type of data marker. The default value for this field is automatically selected from the list of data marker types and cannot be 0x0000. **MUST** be a value from the following table:

Value	Meaning
0x0000	No marker.
0x0001	Square markers.
0x0002	Diamond-shaped markers.
0x0003	Triangular markers.
0x0004	Square markers with an X.
0x0005	Square markers with an asterisk.
0x0006	Short bar markers.
0x0007	Long bar markers.
0x0008	Circular markers.
0x0009	Square markers with a plus sign.

A - fAuto (1 bit): A bit that specifies whether the data marker is automatically generated. The default value for this field is 1. **MUST** be a value from the following table:

Value	Meaning
0x0	The data marker is not automatically generated.
0x1	The data marker type, size, and color are automatically generated and the values are set accordingly in this record.

B - reserved1 (3 bits): **MUST** be zero, and **MUST** be ignored.

C - fNotShowInt (1 bit): A bit that specifies whether to show the data marker interior. The default value for this field is 0. **MUST** be a value from the following table:

Value	Meaning
0x0	The data marker interior is shown.
0x1	The data marker interior is not shown.

D - fNotShowBrd (1 bit): A bit that specifies whether to show the data marker border. The default value for this field is 0. MUST be a value from the following table:

Value	Meaning
0x0	The data marker border is shown.
0x1	The data marker border is not shown.

reserved2 (10 bits): MUST be zero, and MUST be ignored.

icvFore (2 bytes): An [IcvChart](#) structure that specifies the border color of the data marker. The color MUST match the color specified by **rgbFore**. The default value of this field is automatically set to match the color specified by **rgbFore**.

icvBack (2 bytes): An [IcvChart](#) structure that specifies the interior color of the data marker. The color MUST match the color specified by **rgbBack**. The default value of this field is automatically set to match the color specified by **rgbBack**.

miSize (4 bytes): An unsigned integer that specifies the size in **twips** of the data marker. MUST be greater than or equal to 40 and less than or equal to 1440. The default value for this field is 100.

2.4.161 MDB

The **MDB** record specifies a unique set of [MDX metadata](#) type/value pairs that are shared among all **cells** in the **workbook** that reference **MDX** metadata.

0	1	2	3	4	5	6	7	8	9	10	11	12	13	14	15	16	17	18	19	20	21	22	23	24	25	26	27	28	29	30	31
frtHeader																															
...																															
...																															
rgmdir (variable)																															
...																															

frtHeader (12 bytes): An [FrtHeader](#) structure. The **frtHeader.rt** field MUST be 0x88A.

rgmdir (variable): An array of [MDir](#) structures that specifies a block of [metadata](#) records.

2.4.162 MDTInfo

The **MDTInfo** record specifies the information about a single type of [metadata](#).

0	1	2	3	4	5	6	7	8	9	10	11	12	13	14	15	16	17	18	19	20	21	22	23	24	25	26	27	28	29	30	31
frtHeader																															

...																											
...																											
A	B	C	D	E	F	G	H	I	J	K	L	M	N	O	P	Q	R	S	T	U	V	W	unused1	X	Y	Z	a
stName (variable)																											
...																											

frtHeader (12 bytes): An [FrtHeader](#) structure. The **frtHeader.rt** field MUST be 0x0884.

- A - fGhostRow (1 bit):** A bit that specifies whether the metadata is applied to all **cells** in newly inserted rows.
- B - fGhostCol (1 bit):** A bit that specifies whether the metadata is applied to all cells in newly inserted columns.
- C - fEdit (1 bit):** A bit that specifies whether the metadata is preserved when the cell is edited.
- D - fDelete (1 bit):** A bit that specifies whether the metadata is preserved when the cell's value is deleted.
- E - fCopy (1 bit):** A bit that specifies whether the metadata is copied when the cell is copied. MUST be 1 if one or more of the values of **fPasteAll**, **fPasteFormulas**, **fPasteValues**, **fPasteFormats**, **fPasteComments**, **fPasteDataValidation**, **fPasteBorders**, **fPasteColWidths**, or **fPasteNumberFormats** is 1.
- F - fPasteAll (1 bit):** A bit that specifies whether the metadata is pasted when all formulas, values, formatting, comments, and **data validation** rules are pasted from the previously copied cell.
- G - fPasteFormulas (1 bit):** A bit that specifies whether the metadata is pasted when only formulas are pasted from the previously copied cell.
- H - fPasteValues (1 bit):** A bit that specifies whether the metadata is pasted when only values are pasted from the previously copied cell.
- I - fPasteFormats (1 bit):** A bit that specifies whether the metadata is pasted when only formatting is pasted from the previously copied cell.
- J - fPasteComments (1 bit):** A bit that specifies whether the metadata is pasted when only comments are pasted from the previously copied cell.
- K - fPasteDataValidation (1 bit):** A bit that specifies whether the metadata is pasted when only data validation rules are pasted from the previously copied cell.
- L - fPasteBorders (1 bit):** A bit that specifies whether the metadata is pasted when only borders are pasted from the previously copied cell.
- M - fPasteColWidths (1 bit):** A bit that specifies whether the metadata is pasted when only column widths are pasted from the previously copied cell.
- N - fPasteNumberFormats (1 bit):** A bit that specifies whether the metadata is pasted when only number formatting is pasted from the previously copied cell.
- O - fMerge (1 bit):** A bit that specifies whether the metadata is preserved after cells are merged. If the value of this bit is 1, and the cell has the smallest row and column number of the cells that are being merged, the metadata is preserved.

- P - fSplitFirst (1 bit):** A bit that specifies whether, when a cell is split, the metadata is copied to the cell with the smallest row and column number. If **fSplitAll** is set to 1, **fSplitAll** takes precedence.
- Q - fSplitAll (1 bit):** A bit that specifies whether, when a cell is split, the metadata is copied to all the resulting cells. If the value is 1, the value of **fSplitFirst** MUST be ignored.
- R - fRowColShift (1 bit):** A bit that specifies whether the metadata is preserved when the cell is shifted because of row or column deletion or insertion.
- S - fClearAll (1 bit):** A bit that specifies whether the metadata is preserved when the contents, formatting, and comments of the cell are cleared.
- T - fClearFormats (1 bit):** A bit that specifies whether the metadata is preserved when the formatting of the cell is cleared.
- U - fClearContents (1 bit):** A bit that specifies whether the metadata is preserved when the contents of the cell is cleared.
- V - fClearComments (1 bit):** A bit that specifies whether the metadata is preserved when the comments of the cell are cleared.
- W - fAssign (1 bit):** A bit that specifies whether the metadata is preserved when the cell's value is changed by formula (section [2.2.2](#)) assignment.
- unused1 (5 bits):** Undefined and MUST be ignored.
- X - fCoerce (1 bit):** A bit that specifies whether the metadata is preserved when the cell's value is coerced to a different type.
- Y - fAdjust (1 bit):** A bit that specifies whether the metadata is updated when the cell's location is changed.
- Z - fCellMeta (1 bit):** A bit that specifies whether this metadata type is [cell metadata](#) or [value metadata](#). MUST be 0 from the following table:

Value	Meaning
0	Metadata is value metadata.
1	Metadata is cell metadata.

a - unused2 (1 bit): Undefined and MUST be ignored.

stName (variable): An [LPWideString](#) type that specifies the name of the metadata type.

2.4.163 MDXKPI

The **MDXKPI** record specifies [MDX KPI metadata](#).

0	1	2	3	4	5	6	7	8	9	10	11	12	13	14	15	16	17	18	19	20	21	22	23	24	25	26	27	28	29	30	31
frtHeader																															
...																															
...																															

istrConnName		
tfnSrc	kpiprop	istrKPIName
...		istrMbrKPI
...		

frtHeader (12 bytes): An [FrtHeader](#) structure. The **frtHeader.rt** field MUST be 0x889.

istrConnName (4 bytes): An [MDXStrIndex](#) structure that specifies the index of the connection name string.

tfnSrc (1 byte): A [Tag Fn MDX](#) enumeration that specifies the type of **MDX function** that generated the metadata. The value MUST be **TFNCUBEKPIPROPERTY**.

kpiprop (1 byte): A [KPIProp](#) enumeration that specifies the KPI type.

istrKPIName (4 bytes): An MDXStrIndex structure that specifies the index of the **MDX unique name** string.

istrMbrKPI (4 bytes): An MDXStrIndex structure that specifies the index of the key performance indicator name string.

2.4.164 MDXProp

The **MDXProp** record specifies [member property MDX metadata](#).

0	1	2	3	4	5	6	7	8	9	10	11	12	13	14	15	16	17	18	19	20	21	22	23	24	25	26	27	28	29	30	31
frtHeader																															
...																															
...																															
istrConnName																															
tfnSrc																istrMbr															
...																istrProp															
...																															

frtHeader (12 bytes): An [FrtHeader](#) structure. The **frtHeader.rt** field MUST be 0x888.

istrConnName (4 bytes): An [MDXStrIndex](#) structure that specifies the index of the connection name string.

tfnSrc (1 byte): A [Tag Fn MDX](#) enumeration that specifies the type of **MDX function** that generated the metadata. The value MUST be **TFNCUBEMEMBERPROPERTY**.

istrMbr (4 bytes): An MDXStrIndex structure that specifies the index of the **MDX unique name** string.

istrProp (4 bytes): An MDXStrIndex structure that specifies the index of the property name string.

2.4.165 MDXSet

The **MDXSet** record specifies [MDX set metadata](#).

0	1	2	3	4	5	6	7	8	9	10	11	12	13	14	15	16	17	18	19	20	21	22	23	24	25	26	27	28	29	30	31
frtHeader																															
...																															
...																															
istrConnName																															
tfnSrc								sso								istrSetDef															
...																cistr															
...																rgistr (variable)															
...																															

frtHeader (12 bytes): An [FrtHeader](#) structure. The **frtHeader.rt** field MUST be 0x887.

istrConnName (4 bytes): An [MDXStrIndex](#) structure that specifies the index of the connection name string.

tfnSrc (1 byte): A [Tag Fn MDX](#) enumeration that specifies the type of **cube function** that generated the metadata. The value MUST be equal to **TFNCUBESET** or **TFNCUBESETCOUNT**.

sso (1 byte): An [SD_SetSortOrder](#) enumeration that specifies the set **sort order**.

istrSetDef (4 bytes): An MDXStrIndex structure that specifies the index of the set definition string.

cistr (4 bytes): A signed integer that specifies the number of **MDX unique name** strings. The value MUST be greater than or equal to 0, and less than or equal to the total number of [MDXStr](#) records in the file.

rgistr (variable): An array of MDXStrIndex structures that specifies the indexes of the MDX unique name strings. The number of the elements in the array MUST be equal to the value of **cistr**.

2.4.166 MDXStr

The **MDXStr** record specifies a shared text string used by records specifying [MDX metadata](#).

0	1	2	3	4	5	6	7	8	9	10	11	12	13	14	15	16	17	18	19	20	21	22	23	24	25	26	27	28	29	30	31
frtHeader																															

...
...
st (variable)
...

frtHeader (12 bytes): An [FrtHeader](#) structure. The **frtHeader.rt** field MUST be 0x885.

st (variable): An [LPWideString](#) type that specifies the content of the string.

2.4.167 MDXTuple

The **MDXTuple** record specifies [MDX tuple metadata](#).

0	1	2	3	4	5	6	7	8	9	10	11	12	13	14	15	16	17	18	19	20	21	22	23	24	25	26	27	28	29	30	31
frtHeader																															
...																															
...																															
istrConnName																															
tfnSrc																cistr															
...																rjstr (variable)															
...																															

frtHeader (12 bytes): An [FrtHeader](#) structure. The **frtHeader.rt** field MUST be 0x886.

istrConnName (4 bytes): An [MDXStrIndex](#) structure that specifies the index of the connection name string.

tfnSrc (1 byte): A [Tag Fn MDX](#) enumeration that specifies the type of **MDX function** that generated the metadata. The value MUST be equal to **TFNCUBEMEMBER**, **TFNCUBEVALUE**, or **TFNCUBERANKEDMEMBER**.

cistr (4 bytes): A signed integer that specifies the number of **MDX unique name** strings. The value MUST be greater than or equal to 0, and less than or equal to the total number of [MDXStr](#) records in the file.

rjstr (variable): An array of [MDXStrIndex](#) structures that specifies the indexes of the MDX unique name strings. The number of the elements in the array MUST be equal to the value of **cistr**.

2.4.168 MergeCells

The **MergeCells** record specifies **merged cells** in the document. If the count of the merged cells in the document is greater than 1026, the file will contain multiple adjacent **MergeCells** records.

0	1	2	3	4	5	6	7	8	9	10	11	12	13	14	15	16	17	18	19	20	21	22	23	24	25	26	27	28	29	30	31
cmcs																rgref (variable)															
...																															

cmcs (2 bytes): An unsigned integer that specifies the count of [Ref8](#) structures. MUST be less than or equal to 1026.

rgref (variable): An array of Ref8 structures. Each array element specifies a **range of cells** that are merged into a single merged cell. These ranges MUST NOT overlap. MUST contain the number of elements specified by **cmcs**.

2.4.169 Mms

The **Mms** record is reserved and MUST be ignored.

0	1	2	3	4	5	6	7	8	9	10	11	12	13	14	15	16	17	18	19	20	21	22	23	24	25	26	27	28	29	30	31
reserved1										reserved2																					

reserved1 (1 byte): MUST be zero, and MUST be ignored.

reserved2 (1 byte): MUST be zero, and MUST be ignored.

2.4.170 MsoDrawing

The **MsoDrawing** record specifies a **drawing**. If this record is in the [Worksheet](#), [Macro Sheet](#), or [Dialog Sheet](#) substream, the **OfficeArtClientAnchor** structure mentioned in [MS-ODRAW] refers to the [OfficeArtClientAnchorSheet](#) structure. If this record appears in the [Chart Sheet](#) substream, the **OfficeArtClientAnchor** structure mentioned in [MS-ODRAW] refers to the [OfficeArtClientAnchorChart](#) structure.

0	1	2	3	4	5	6	7	8	9	10	11	12	13	14	15	16	17	18	19	20	21	22	23	24	25	26	27	28	29	30	31
rgChildRec (variable)																															
...																															

rgChildRec (variable): An **OfficeArtDgContainer** structure as specified in [MS-ODRAW] that specifies the drawing. If the **rgChildRec** has a **shape** structure in it as specified in [MS-ODRAW] and that **shape** has a **clientData** record in it as specified in [MS-ODRAW], then the next record following this record MUST be an [Obj](#). The size of the **clientData** record does not include the size of the following Obj record. If the **rgChildRec** has a **shape** structure in it as specified in [MS-ODRAW] and that **shape** has a **clientTextbox** record in it as specified in [MS-ODRAW], then the next record following this record MUST be a [TxO](#). The size of the **clientTextbox** record does not include the size of this TxO record.

2.4.171 MsoDrawingGroup

The **MsoDrawingGroup** record specifies a group of **drawing objects**.

0	1	2	3	4	5	6	7	8	9	10	11	12	13	14	15	16	17	18	19	20	21	22	23	24	25	26	27	28	29	30	31
rgChildRec (variable)																															
...																															

rgChildRec (variable): An **OfficeArtDggContainer** as specified in [\[MS-ODRAW\]](#) that specifies the group of drawing objects.

2.4.172 MsoDrawingSelection

The **MsoDrawingSelection** record specifies **selected drawing objects** and the drawing objects in focus on the **sheet**.

0	1	2	3	4	5	6	7	8	9	10	11	12	13	14	15	16	17	18	19	20	21	22	23	24	25	26	27	28	29	30	31
selection (variable)																															
...																															

selection (variable): An **OfficeArtFDGSL** structure as specified in [\[MS-ODRAW\]](#) section 2.2.33 that specifies the selected drawing objects.

2.4.173 MTRSettings

The **MTRSettings** record specifies multithreaded calculation settings.

0	1	2	3	4	5	6	7	8	9	10	11	12	13	14	15	16	17	18	19	20	21	22	23	24	25	26	27	28	29	30	31
frtHeader																															
...																															
...																															
fMTREnabled																															
fUserSetThreadCount																															
cUserThreadCount																															

frtHeader (12 bytes): An [FrtHeader](#) structure. The **frtHeader.rt** field MUST be 0x089A.

fMTREnabled (4 bytes): A Boolean (section [2.5.14](#)) that specifies whether the multithreaded calculation is enabled. MUST be a value from the following table:

Value	Meaning
0x00000000	Multithreaded calculation is disabled.

Value	Meaning
0x00000001	Multithreaded calculation is enabled.

fUserSetThreadCount (4 bytes): A Boolean that specifies whether the thread count was manually specified by the user. MUST be a value from the following table:

Value	Meaning
0x00000000	The thread count cUserThreadCount was not manually specified by the user.
0x00000001	The thread count cUserThreadCount was manually specified by the user.

cUserThreadCount (4 bytes): A signed integer that specifies the count of calculation threads. MUST be greater than or equal to 0x00000001 and MUST be less than or equal to 0x00000400. If **fMTREnabled** is 0x00000000 or **fUserSetThreadCount** is 0x00000000, the value of this field MUST be ignored.

2.4.174 MulBlank

The **MulBlank** record specifies a [series](#) of blank **cells** in a **sheet** row. This record can store up to 256 [IXFCell](#) structures.

0	1	2	3	4	5	6	7	8	9	10	1	2	3	4	5	6	7	8	9	20	1	2	3	4	5	6	7	8	9	30	1
rw										colFirst																					
rgixfe (variable)																															
...																															
colLast																															

rw (2 bytes): An [Rw](#) structure that specifies a row containing the blank cells.

colFirst (2 bytes): A [Col](#) structure that specifies the first column in the series of blank cells within the sheet. The value of **colFirst.col** MUST be less than or equal to 254.

rgixfe (variable): An array of [IXFCell](#) structures. Each element of this array contains an [IXFCell](#) structure corresponding to a blank cell in the series. The number of entries in the array MUST be equal to the value given by the following formula:

$$\text{Number of entries in rgixfe} = (\text{colLast.col} - \text{colFirst.col} + 1)$$

colLast (2 bytes): A [Col](#) structure that specifies the last column in the series of blank cells within the sheet. This **colLast.col** value MUST be greater than **colFirst.col** value.

2.4.175 MulRk

The **MulRk** record specifies a [series](#) of **cells** with numeric data in a **sheet** row. This record can store up to 256 [RkRec](#) structures.

0	1	2	3	4	5	6	7	8	9	10	11	12	13	14	15	16	17	18	19	20	21	22	23	24	25	26	27	28	29	30	31
rw																colFirst															
rgrkrec (variable)																															
...																															
colLast																															

rw (2 bytes): An [Rw](#) structure that specifies the row containing the cells with numeric data.

colFirst (2 bytes): A [Col](#) structure that specifies the first column in the series of numeric cells within the sheet. The value of **colFirst.col** MUST be less than or equal to 254.

rgrkrec (variable): An array of [RkRec](#) structures. Each element in the array specifies an [RkRec](#) in the row. The number of entries in the array MUST be equal to the value given by the following formula:

$$\text{Number of entries in rgrkrec} = (\text{colLast.col} - \text{colFirst.col} + 1)$$

colLast (2 bytes): A [Col](#) structure that specifies the last column in the set of numeric cells within the sheet. This **colLast.col** value MUST be greater than the **colFirst.col** value.

2.4.176 NameCmt

The **NameCmt** record specifies a **comment** associated with a **defined name**.

0	1	2	3	4	5	6	7	8	9	10	11	12	13	14	15	16	17	18	19	20	21	22	23	24	25	26	27	28	29	30	31
frtHeader																															
...																															
...																															
cchName																cchComment															
name (variable)																															
...																															
comment (variable)																															
...																															

frtHeader (12 bytes): An [FrthHeader](#) structure. The **frtHeader.rt** field MUST be 0x0894.

cchName (2 bytes): An unsigned integer that specifies the number of characters in the **name**. The value MUST be less than or equal to 0x00FF.

cchComment (2 bytes): An unsigned integer that specifies the number of characters in the **comment**. The value MUST be less than or equal to 0x00FF.

name (variable): An [XLUnicodeStringNoCch](#) structure that specifies the defined name; **cchName** specifies the number of characters in this string. This string MUST satisfy the formatting restrictions specified in the [XLNameUnicodeString](#) structure. This string MUST also satisfy the following formatting restriction based on the **fBuiltin** field in the preceding [Lbl](#) record:

Value of fBuiltin field in the preceding Lbl record	Restrictions on this field
0	The string in this field MUST be the same string (using case-insensitive comparison) as the string in the name field of the preceding Lbl record.
1	The string in this field MUST be the defined name associated with the built-in name number that appears in the name field in the preceding Lbl record.

comment (variable): An [XLUnicodeStringNoCch](#) structure that specifies the comment; **cchComment** specifies the number of characters in this string.

2.4.177 NameFnGrp12

The **NameFnGrp12** record specifies the name of a **function** in a **function category** that is specified in an [FnGrp12](#) record.

0	1	2	3	4	5	6	7	8	9	10	11	12	13	14	15	16	17	18	19	20	21	22	23	24	25	26	27	28	29	30	31
frtHeader																															
...																															
...																															
cachName																fgrp															
rgach (variable)																															
...																															

frtHeader (12 bytes): An [FrtHeader](#) structure. The **frtHeader.rt** field MUST be 0x0899.

cachName (2 bytes): An unsigned integer that specifies the number of characters in the name of the function. The value MUST be greater than or equal to 1 and less than or equal to 255.

fgrp (2 bytes): An unsigned integer that specifies the zero-based index of the function category that this function belongs to. This value minus 32 specifies the zero-based index of an [FnGrp12](#) record

in the collection of FnGrp12 records, as specified by the [Globals Substream ABNF](#). MUST be greater than or equal to 32 and less than or equal to 255.

rgach (variable): An [XLNameUnicodeString](#) structure that specifies the name of the function. The length MUST be equal to **cachName**.

2.4.178 NamePublish

The **NamePublish** record specifies information about a **defined name**.

0	1	2	3	4	5	6	7	8	9	10	11	12	13	14	15	16	17	18	19	20	21	22	23	24	25	26	27	28	29	30	31
frtHeader																															
...																															
...																															
A	B	unused														strName (variable)															
...																															

frtHeader (12 bytes): An [FrtHeader](#) structure. The **frtHeader.rt** field MUST be 0x0893.

A - fPublished (1 bit): A bit that specifies whether the defined name is published to a server. This bit is ignored if the **fPublishedBookItems** field of the [BookExt Conditional12](#) structure is 0.

B - fWorkbookParam (1 bit): A bit that specifies whether the defined name is a **workbook parameter**.

unused (14 bits): Undefined and MUST be ignored.

strName (variable): An [XLNameUnicodeString](#) structure that specifies the defined name.

2.4.179 Note

The **Note** record specifies a **comment** associated with a **cell** or revision information about a comment associated with a cell.

0	1	2	3	4	5	6	7	8	9	10	11	12	13	14	15	16	17	18	19	20	21	22	23	24	25	26	27	28	29	30	31
body (variable)																															
...																															

body (variable): A variable type field. The data type and meaning of this field is determined by the stream that contains this record, as specified in the following table:

Stream that contains this record	Body field data type and meaning
Workbook stream In the Workbook stream the record MUST be in a Worksheet substream , a Dialog Sheet substream , or	A NoteSh structure that specifies a comment associated with a cell.

Stream that contains this record	Body field data type and meaning
a Macro Sheet substream .	
Revision stream (revision log)	A NoteRR structure that specifies a revision record for a comment associated with a cell.

2.4.180 Number

The **Number** record specifies a **cell** that contains a **floating-point number**.

0	1	2	3	4	5	6	7	8	9	10	11	12	13	14	15	16	17	18	19	20	21	22	23	24	25	26	27	28	29	30	31
cell																															
...																num															
...																															
...																															

cell (6 bytes): A [Cell](#) structure that specifies the cell.

num (8 bytes): An Xnum (section [2.5.342](#)) value that specifies the cell value.

If this record appears in a [SERIESDATA](#) record collection, and this record specifies a cell in the [chart data cache](#) that specifies data for an [error bar series](#), then this field is a [ChartNumNillable](#) value. If a [ChartNumNillable](#) is used, a blank cell is specified by a [NilChartNum](#) structure that has a **type** field with a value of 0x0000, and a cell with a #N/A error is specified by a [NilChartNum](#) that has a **type** field with a value of 0x0100.

2.4.181 Obj

The **Obj** record specifies the properties of an object in a **sheet**.

0	1	2	3	4	5	6	7	8	9	10	11	12	13	14	15	16	17	18	19	20	21	22	23	24	25	26	27	28	29	30	31
cmo (22 bytes)																															
...																															
...																															
...																gmo (optional)															
...																															
pictFormat (optional)																															

...	pictFlags (optional)
...	
cbls (16 bytes, optional)	
...	
...	
rbo (optional)	
...	
...	sbs (24 bytes, optional)
...	
...	
...	nts (26 bytes, optional)
...	
...	
...	
macro (variable)	
...	
pictFmla (variable)	
...	
linkFmla (variable)	
...	
checkBox (optional)	
...	
...	
radioButton (optional)	
...	

edit (optional)	
...	
...	
list (variable)	
...	
gbo (optional)	
...	
...	reserved (optional)
...	

cmo (22 bytes): An [FtCmo](#) structure that specifies the common properties of this object.

gmo (6 bytes): An optional [FtGmo](#) structure that specifies the properties of this group object. This field MUST exist if and only if **cmo.ot** is equal to 0x00.

pictFormat (6 bytes): An optional [FtCf](#) structure that specifies the format of this picture object. This field MUST exist if and only if **cmo.ot** is equal to 0x08.

pictFlags (6 bytes): An optional [FtPioGrbit](#) structure that specifies additional properties of this picture object. This field MUST exist if and only if **cmo.ot** is equal to 0x08.

cbIs (16 bytes): An optional [FtCbIs](#) structure that represents a check box or radio button. This field MUST exist if and only if **cmo.ot** is equal to 0x0B or 0x0C.

rbo (10 bytes): An optional [FtRbo](#) structure that represents a radio button. This field MUST exist if and only if **cmo.ot** is equal to 0x0C.

sbs (24 bytes): An optional [FtSbs](#) structure that specifies the properties of this spin control, scrollbar, list, or drop-down list object. This field MUST exist if and only if **cmo.ot** is equal to 0x10, 0x11, 0x12, or 0x14.

nts (26 bytes): An optional [FtNts](#) structure that specifies the properties of this **comment** object. This field MUST exist if and only if **cmo.ot** is equal to 0x19.

macro (variable): An optional [FtMacro](#) structure that specifies the action associated with this object.

pictFmla (variable): An optional [FtPictFmla](#) structure that specifies the location of the data associated with this picture object. This field MUST NOT exist unless **cmo.ot** is equal to 0x08.

linkFmla (variable): An optional [ObjLinkFmla](#) structure that specifies the formula (section [2.2.2](#)) that specifies a **range** that has a value linked to this object. This field MUST NOT exist unless **cmo.ot** is equal to 0x0B, 0x0C, 0x10, 0x11, 0x12, or 0x14. The value of **linkFmla.ft** MUST equal 0x14 if **cmo.ot** is equal to 0x0B or 0x0C. Otherwise, **linkFmla.ft** MUST equal 0x0E.

checkBox (12 bytes): An optional [FtCbIsData](#) structure that specifies the properties of this check box or radio button object. This field MUST exist if and only if **cmo.ot** is equal to 0x0B or 0x0C.

radioButton (8 bytes): An optional [FtRboData](#) structure that specifies additional properties of this radio button object. This field MUST exist if and only if **cmo.ot** is equal to 0x0C.

edit (12 bytes): An optional [FtEdoData](#) structure that specifies the properties of this edit box object. This field MUST exist if and only if **cmo.ot** is equal to 0x0D.

list (variable): An optional [FtLbsData](#) structure that specifies the properties of this list box or drop-down object. This field MUST exist if and only if **cmo.ot** is equal to 0x12 or 0x14.

gbo (10 bytes): An optional [FtGboData](#) structure that specifies the properties of this group box object. This field MUST exist if and only if **cmo.ot** is equal to 0x13.

reserved (4 bytes): Optional. MUST be 0, and MUST be ignored. This field MUST exist if and only if **cmo.ot** does not equal 0x12 or 0x14.

2.4.182 ObjectLink

The **ObjectLink** record specifies an object on a [chart](#), or the entire chart, to which the [Text](#) record is linked.

0	1	2	3	4	5	6	7	8	9	10	11	12	13	14	15	16	17	18	19	20	21	22	23	24	25	26	27	28	29	30	31
wLinkObj																wLinkVar1															
wLinkVar2																															

wLinkObj (2 bytes): An unsigned integer that specifies the object that the Text record is linked to. MUST be a value from the following table:

Value	Meaning
0x0001	Entire chart.
0x0002	Value axis , or vertical value axis on bubble and scatter chart groups
0x0003	Category axis, or horizontal value axis on bubble and scatter chart groups.
0x0004	Series or data points .
0x0007	Series axis.
0x000C	Display units labels of an axis.

wLinkVar1 (2 bytes): An unsigned integer that specifies the zero-based index into a [Series](#) record in the collection of Series records in the current Chart Sheet substream. Each referenced Series record specifies a series for the chart group to which the Text record is linked. When the **wLinkObj** field is 4, MUST be less than or equal to 254. When the **wLinkObj** field is not 4, MUST be zero, and MUST be ignored.

wLinkVar2 (2 bytes): An unsigned integer that specifies the zero-based index into the **category (2)** within the series specified by **wLinkVar1**, to which the Text record is linked. When the **wLinkObj** field is 4, if the Text record is linked to a series instead of a single data point, the value MUST be 0xFFFF; if the Text record is linked to a data point, the value MUST be less than or equal to 31999. When the **wLinkObj** field is not 4, MUST be zero, and MUST be ignored.

2.4.183 ObjProtect

The **ObjProtect** record specifies the **protection** state of the objects on the **sheet**. This record exists if the sheet is **protected** and the objects on the sheet are protected.

0	1	2	3	4	5	6	7	8	9	10	11	12	13	14	15	16	17	18	19	20	21	22	23	24	25	26	27	28	29	30	31
fLockObj																															

fLockObj (2 bytes): A Boolean (section [2.5.14](#)) that specifies that the objects are protected. MUST be 0x0001.

2.4.184 ObNoMacros

The existence of the **ObNoMacros** record specifies that an **ObProj** record exists in the file, and that there are no **forms**, **modules**, or **class modules** in the **VBA project** located in the **VBA storage** stream.

2.4.185 ObProj

The existence of the **ObProj** record specifies that there is a **VBA project** in the file. This project is located in the **VBA storage** stream.

2.4.186 OleDbConn

The **OleDbConn** record specifies the connection information for an **OLE DB connection string**, and specifies the beginning of a collection of **ExtString** records as defined by the **Worksheet Substream ABNF**. The collection of ExtString records specifies the connection string for a **query** that retrieves **external data**.

0	1	2	3	4	5	6	7	8	9	10	11	12	13	14	15	16	17	18	19	20	21	22	23	24	25	26	27	28	29	30	31
frtHeaderOld																															
A	B	reserved1														cst															
reserved2																															

frtHeaderOld (4 bytes): An [FrtHeaderOld](#) structure. The **frtHeaderOld.rt** field MUST be 0x080A.

A - fPasswd (1 bit): A bit that specifies whether the connection password is present in the connection string. A value of 1 specifies that the password was stripped from the connection string.

B - fLocal (1 bit): A bit that specifies whether the connection string is the main connection string or an alternate connection string. See [ConnGrbitDbtOledb](#) for more information.

reserved1 (14 bits): MUST be zero, and MUST be ignored.

cst (2 bytes): An unsigned integer that specifies the number of ExtString records that follow this record. MUST be greater than 0. If the value is 1, the connection string is specified by ExtString.**string**. If the value is greater than 1, the connection string is determined by concatenating each of the ExtString.**string** fields of the ExtString records that follow.

reserved2 (4 bytes): MUST be zero, and MUST be ignored.

2.4.187 OleObjectSize

The **OleObjectSize** record specifies the visible **range of cells** when this **workbook** is displayed as an **embedded object** in another document.

0	1	2	3	4	5	6	7	8	9	10	11	12	13	14	15	16	17	18	19	20	21	22	23	24	25	26	27	28	29	30	31
unused																ref															
...																															

unused (2 bytes): Undefined and MUST be ignored.

ref (6 bytes): A [RefU](#) structure that specifies the visible range of cells, if the workbook is an embedded object and the **active sheet** is a **worksheet**, a **macro sheet**, or a **dialog sheet** as specified by the **itabCur** field of a [Window1](#) record. Otherwise, **ref** is undefined and MUST be ignored.

2.4.188 Palette

The **Palette** record specifies a **custom color palette**.

0	1	2	3	4	5	6	7	8	9	10	11	12	13	14	15	16	17	18	19	20	21	22	23	24	25	26	27	28	29	30	31
ccv																rgColor (variable)															
...																															

ccv (2 bytes): A signed integer that specifies the number of colors in the **rgColor** array. The value MUST be 56.

rgColor (variable): An array of [LongRGB](#) structures that specifies the colors of the **color palette**. The number of items in the array MUST be equal to the value specified in the **ccv** field.

2.4.189 Pane

The **Pane** record specifies the position of **frozen panes** or unfrozen panes in the window used to display the **sheet**.

0	1	2	3	4	5	6	7	8	9	10	11	12	13	14	15	16	17	18	19	20	21	22	23	24	25	26	27	28	29	30	31
x																y															
rwTop																colLeft															
pnnAcct								reserved																							

x (2 bytes): An unsigned integer that specifies the horizontal position of the split in the pane. If the value of **fFrozenRt** in the preceding [Window2](#) record is 1, the value of **x** is measured in cells and

MUST be less than or equal to 255. If the value of **fFrozenRt** in the preceding Window2 is 0, the value of **x** is measured in **twips**, and MUST be less than or equal to 32767.

y (2 bytes): An unsigned integer that specifies the vertical position of the split in the pane. If the value of **fFrozenRt** in the preceding Window2 record is 1, the value of **y** is measured in cells. If the value of **fFrozenRt** in the preceding Window2 is 0, the value of **y** is measured in twips, and MUST be less than or equal to 32767.

rwTop (2 bytes): An [RwU](#) structure that specifies the topmost **visible** row in the bottom pane.

colLeft (2 bytes): A [ColU](#) structure that specifies the first visible **logical left** column in the **logical right** pane.

pnnAcct (1 byte): A [PaneType](#) enumeration that specifies the active pane.

reserved (1 byte): MUST be zero, and MUST be ignored.

2.4.190 ParamQry

The **ParamQry** record specifies the parameters for a **parameterized query**.

0	1	2	3	4	5	6	7	8	9	10	1	2	3	4	5	6	7	8	9	20	1	2	3	4	5	6	7	8	9	30	1
fixed																															
...																															
rgb (variable)																															
...																															

fixed (8 bytes): A [PARAMQRY Fixed](#) structure that specifies the type information of the parameters.

rgb (variable): Variable type field that specifies a parameter for a parameterized query. The data type and meaning are specified in the following table:

Value of fixed.pbt	Value of fixed.grbit	Meaning
0	Any	rgb is an SXString followed by an unused byte.
1	0x001	rgb is an Xnum (section 2.5.342).
1	0x002	rgb is an SXString followed by an unused byte.
1	0x800	rgb is a 4-byte signed integer.
2	Any	rgb is an FMSEr_param that specifies the cell reference containing the parameter.

2.4.191 Password

The **Password** record specifies the password verifier for the **sheet** or **workbook**. If this record exists in the [Globals Substream](#), then it is a password for the workbook. If this record exists in a [worksheet substream](#), [chart sheet substream](#), [macro sheet substream](#), or [dialog sheet substream](#), then it is a password for only that sheet. This record MUST exist for the workbook. A sheet has a password if and only if this record exists.

0	1	2	3	4	5	6	7	8	9	1	0	1	2	3	4	5	6	7	8	9	2	0	1	2	3	4	5	6	7	8	9	3	0	1
wPassword																																		

wPassword (2 bytes): An unsigned integer that specifies the password verifier <100>. See [Password Verifier Algorithm](#) for more information. If the password is for a sheet, MUST NOT equal 0x0000. If **wPassword** is 0x0000 it means the workbook has no password.

2.4.192 PhoneticInfo

The **PhoneticInfo** record specifies the default format for **phonetic strings** and the **ranges** of **cells** on the **sheet** that have phonetic strings that are **visible**.

0	1	2	3	4	5	6	7	8	9	1	0	1	2	3	4	5	6	7	8	9	2	0	1	2	3	4	5	6	7	8	9	3	0	1
phs																																		
sqref (variable)																																		
...																																		

phs (4 bytes): A [Phs](#) structure that specifies the default format for phonetic strings on the sheet. When a phonetic string is entered into a cell that does not already contain a phonetic string, the default format is applied to the phonetic string.

sqref (variable): An [SqRef](#) structure that specifies the ranges of cells on the sheet that have phonetic strings that are visible.

2.4.193 PicF

The **PicF** record specifies the layout of a picture that is attached to a picture-filled chart element.

0	1	2	3	4	5	6	7	8	9	1	0	1	2	3	4	5	6	7	8	9	2	0	1	2	3	4	5	6	7	8	9	3	0	1
ptyp											unused																							
reserved1									A	B	C	D				numScale																		
...																																		
...																																		

ptyp (2 bytes): An unsigned integer that specifies the picture layout. If this record is not located in the sequence of records that conform to the [SS](#) rule, as specified by the Chart Sheet Substream **ABNF**, then this field MUST be 0x0001. If this record is located in the sequence of records that conform to the [SS](#) rule, then this field MUST be a value from the following table:

Value	Meaning
0x0001	Stretched. The picture is scaled to fit within the dimensions of the filled areas of the chart element.

Value	Meaning
0x0002	Stacked. The pictures in the data points are stacked on top of each other in the direction of the value axis .
0x0003	Stacked and scaled. The pictures in the data points are stacked next to or on top of each other, and each picture is scaled to fit in the number of units on the value axis as specified by numScale .

unused (2 bytes): Undefined and MUST be ignored.

reserved1 (9 bits): MUST be zero, and MUST be ignored.

A - fTopBottom (1 bit): A bit that specifies whether the picture covers the top and bottom fill areas of the data points. The top and bottom fill areas of the data points are parallel to the **floor** in a 3-D **plot area**. If a [Chart3d](#) record does not exist in the chart sheet substream, or if this record is not in an SS rule or if this record is in an SS rule that contains a [Chart3DBarShape](#) record with the **riser** field equal to 0x01, this field MUST be 1.

B - fBackFront (1 bit): A bit that specifies whether the picture covers the front and back fill areas of the data points on a bar or column [chart group](#). If a Chart3d record does not exist in the chart sheet substream, or if this record is not in an SS rule or if this record is in an SS rule that contains a Chart3DBarShape record with the **riser** field equal to 0x01, this field MUST be 1.

C - fSide (1 bit): A bit that specifies whether the picture covers the side fill areas of the data points on a bar or column chart group. If a Chart3d record does not exist in the chart sheet substream, or if this record is not in an SS rule or if this record is in an SS rule that contains a Chart3DBarShape record with the **riser** field equal to 0x01, this field MUST be 1.

D - reserved2 (4 bits): MUST be zero, and MUST be ignored.

numScale (8 bytes): An Xnum (section [2.5.342](#)) that specifies the number of units on the value axis in which to fit the entire picture. The picture is scaled to fit within this number of units. If the value of **ptyp** is not 0x0003, this field is undefined and MUST be ignored.

2.4.194 Pie

The **Pie** record specifies that the [chart group](#) is a pie chart group or a doughnut chart group, and specifies the chart group attributes.

0	1	2	3	4	5	6	7	8	9	10	1	2	3	4	5	6	7	8	9	20	1	2	3	4	5	6	7	8	9	30	1	
anStart																pcDonut																
A	B	reserved																														

anStart (2 bytes): An unsigned integer that specifies the starting angle of the first [data point](#), clockwise from the top of the circle. MUST be less than or equal to 360.

pcDonut (2 bytes): An unsigned integer that specifies the size of the center hole in a doughnut chart group as a percentage of the **plot area** size. MUST be a value from the following table:

Value	Meaning
0	Pie chart group.
10 to 90	Doughnut chart group.

A - fHasShadow (1 bit): A bit that specifies whether one data point or more data points in the chart group have shadows.

B - fShowLdrLines (1 bit): A bit that specifies whether the **leader lines** to the [data labels](#) are shown.

reserved (14 bits): MUST be zero, and MUST be ignored.

2.4.195 PieFormat

The **PieFormat** record specifies the distance of a data point or data points in a series from the center of one of the following:

- The **plot area** for a doughnut or pie [chart group](#).
- The **primary pie** in a pie of pie or bar of pie chart group.
- The **secondary bar/pie** of a pie of pie chart group.

The data point or data points in a series are specified by the sequence of records that conforms to the [SS](#) rule in the Chart Sheet Substream **ABNF** that contains this record.

MUST NOT exist on chart group types other than pie, doughnut, bar of pie, or pie of pie. MUST NOT exist if the chart group type is doughnut and the series is not the outermost series. MUST NOT exist on the data points on the secondary bar/pie of a bar of pie chart group.

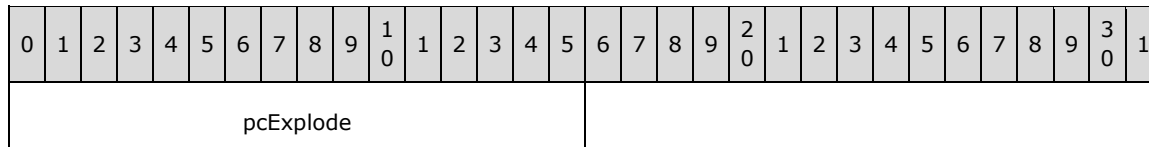

pcExplode (2 bytes): A signed integer that specifies the distance of a data point or data points in a series from the center of one of the following:

- The plot area for a doughnut or pie chart group.
- The primary pie in a pie of pie or bar of pie chart group.
- The secondary bar/pie of a pie of pie chart group.

The value of this field specifies the distance as a percentage. If this value is 0, then the data point or data points in a series is as close to the center as possible for the particular chart group type. If this value is 100, then the data point is at the edge of the **chart area** (section [2.2.3.17](#)). If this value is greater than 100, such that the data point is beyond the edge of the chart area, then all the data points in the chart group are scaled down to fit inside the chart area such that the data point with the highest **pcExplode** value is at the edge of the chart area .

MUST be greater than or equal to 0.

2.4.196 PivotChartBits

The **PivotChartBits** record specifies the flags applicable to a [Pivot Chart](#).

0	1	2	3	4	5	6	7	8	9	10	11	12	13	14	15	16	17	18	19	20	21	22	23	24	25	26	27	28	29	30	31
rt																unused1															
A	unused2															reserved1 (optional)															
reserved2 (optional)																reserved3 (optional)															

rt (2 bytes): An unsigned integer that specifies the [FRT](#) record type. MUST be 0x0859.

unused1 (2 bytes): Undefined, and MUST be ignored.

A - fGXHide (1 bit): A bit that specifies whether to hide the [pivot field](#) captions in the Pivot Chart.

unused2 (15 bits): Undefined, and MUST be ignored.

reserved1 (2 bytes): This field SHOULD [<101>](#) exist. If this field exists, this value MUST be 0x0000, and MUST be ignored.

reserved2 (2 bytes): This field SHOULD [<102>](#) exist. If this field exists, this value MUST be 0x0000, and MUST be ignored.

reserved3 (2 bytes): This field SHOULD [<103>](#) exist. If this field exists, this value MUST be 0x0000, and MUST be ignored.

2.4.197 PlotArea

The **PlotArea** record is empty, specifying that the [Frame](#) record that immediately follows this record specifies properties of the **plot area**.

2.4.198 PlotGrowth

The **PlotGrowth** record specifies the scale factors to use when calculating the **font scaling** information for a **font** in the **plot area**. If no [Fbi](#) record exists in the [chart sheet](#) where **scab** is 0x0001, this record is unused and MUST be ignored. Otherwise, the values from each [Fbi](#) record where **scab** is 0x0001 are used in conjunction with values in this record to render the scaled fonts in the plot area.

0	1	2	3	4	5	6	7	8	9	10	11	12	13	14	15	16	17	18	19	20	21	22	23	24	25	26	27	28	29	30	31
dxPlotGrowth																															
dyPlotGrowth																															

dxPlotGrowth (4 bytes): A **FixedPoint** as specified in [\[MS-OSHARED\]](#) section 2.2.1.6 that specifies the horizontal growth (in **points**) of the plot area for font scaling.

dyPlotGrowth (4 bytes): A **FixedPoint** as specified in [\[MS-OSHARED\]](#) section 2.2.1.6 that specifies the vertical growth (in points) of the plot area for font scaling.

2.4.199 Pls

The **Pls** record specifies printer settings and the printer driver information.

0	1	2	3	4	5	6	7	8	9	10	11	12	13	14	15	16	17	18	19	20	21	22	23	24	25	26	27	28	29	30	31
reserved																rgb (variable)															
...																															

reserved (2 bytes): MUST be zero, and MUST be ignored.

rgb (variable): A **DEVMODE** structure, as defined in [\[DEVMODE\]](#), which specifies the printer settings. The size of this field is equal to the size of the current record and all of the following [Continue](#) records, excluding the record's heading and **reserved** field.

2.4.200 PLV

The **PLV** record specifies the settings of a **Page Layout view** for a **sheet**.

0	1	2	3	4	5	6	7	8	9	10	11	12	13	14	15	16	17	18	19	20	21	22	23	24	25	26	27	28	29	30	31			
frtHeader																																		
...																																		
...																																		
wScalePLV																A	B	C	unused															

frtHeader (12 bytes): An [FrtHeader](#) structure. The **frtHeader.rt** field MUST be 0x088B.

wScalePLV (2 bytes): An unsigned integer that specifies zoom scale as a percentage for the Page Layout view of the current sheet. For example, if the value is 107, then the zoom scale is 107%. The value 0 means that the zoom scale is not set. If the value is nonzero, it MUST be greater than or equal to 10 and less than or equal to 400.

A - fPageLayoutView (1 bit): A bit that specifies whether the sheet is in the Page Layout view. If the **fSLV** in [Window2](#) record is 1 for this sheet, it MUST be 0.

B - fRulerVisible (1 bit): A bit that specifies whether the application displays the **ruler**.

C - fWhitespaceHidden (1 bit): A bit that specifies whether the margins between pages are **hidden** in the Page Layout view.

unused (13 bits): Undefined, and MUST be ignored.

2.4.201 Pos

The **Pos** record specifies the size and position for a [legend](#), an [attached label](#), or the **plot area**, as specified by the primary [axis group](#). This record MUST be ignored for the plot area when the **fManPlotArea** field of [ShtProps](#) in the associated [chart sheet](#) substream is set to 1.

0	1	2	3	4	5	6	7	8	9	10	11	12	13	14	15	16	17	18	19	20	21	22	23	24	25	26	27	28	29	30	31
mdTopLt																mdBotRt															

x1	unused1
y1	unused2
x2	unused3
y2	unused4

mdTopLt (2 bytes): A [PositionMode](#) structure that specifies the positioning mode for the upper-left corner of a legend, an attached label, or the plot area. The valid combinations of **mdTopLt** and **mdBotRt** and the meaning of **x1**, **y1**, **x2**, **y2** are specified in the **Valid Combinations of mdTopLt and mdBotRt by Type** table.

mdBotRt (2 bytes): A [PositionMode](#) structure that specifies the positioning mode for the lower-right corner of a legend, an attached label, or the plot area. The valid combinations of **mdTopLt** and **mdBotRt** and the meaning of **x1**, **y1**, **x2**, **y2** are specified in the following table.

Type	mdTopLt Position Mode	mdBotRt Position Mode	Meaning
plot area (axis group)	MDPARENT	MDPARENT	The values of x1 and y1 specify the horizontal and vertical offsets of the primary axis group's upper-left corner, relative to the upper-left corner of the chart area (section 2.2.3.17), in SPRC . The values of x2 and y2 specify the width and height of the primary axis group, in SPRC .
legend	MDCHART	MDABS	The values x1 and y1 specify the horizontal and vertical offsets of the legend's upper-left corner, relative to the upper-left corner of the chart area (section 2.2.3.17) in SPRC . The values of x2 and y2 specify the width and height of the legend, in points .
legend	MDCHART	MDPARENT	The values of x1 and y1 specify the horizontal and vertical offsets of the legend's upper-left corner, relative to the upper-left corner of the chart area (section 2.2.3.17) in SPRC . The values of x2 and y2 MUST be ignored. The size of the legend is determined by the application.
legend	MDKTH	MDPARENT	The values of x1 , y1 , x2 and y2 MUST be ignored. The legend is located inside a data table .
attached label	MDPARENT	MDPARENT	The meaning of x1 and y1 is specified in the Meaning of x1 and y1 as specified by the Type of Attached Label table. x2 and y2 MUST be ignored. The size of the attached label is determined by the application.

The following table shows the meaning of **x1** and **y1** as specified by the type of attached label.

Type of Attached Label	Meaning
Chart title	The value of x1 and y1 specify the horizontal and vertical offset of the title, relative to its default position, in SPRC .
Axis title	The value of x1 and y1 specify the offset of the title along the direction of a specific axis . The value of x1 specifies an offset along the category (2) axis, date axis, or horizontal value axis. The value of y1 specifies an offset along the value axis. Both offsets are relative to the title's default position, in 1/1000 th of the axis length.

0	1	2	3	4	5	6	7	8	9	10	11	12	13	14	15	16	17	18	19	20	21	22	23	24	25	26	27	28	29	30	31
printRwCol																															

printRwCol (2 bytes): A Boolean (section [2.5.14](#)) that specifies whether the row and column headers are printed. MUST be a value from the following table:

Value	Meaning
0x0000	Row and column headers are not printed.
0x0001	Row and column headers are not printed.

2.4.204 PrintSize

The **PrintSize** record specifies the printed size of the [chart](#). This record affects the charts printed only on their own page.

0	1	2	3	4	5	6	7	8	9	10	11	12	13	14	15	16	17	18	19	20	21	22	23	24	25	26	27	28	29	30	31
printSize																															

printSize (2 bytes): An unsigned integer that specifies the printed size of the chart. MUST be a value from the following table:

Value	Meaning
0x0000	The record is part of a UserSViewBegin block and the print settings are unchanged from the defaults specified in the workbook .
0x0001	The chart is resized to fill the entire page regardless of the original chart proportions, within page margins.
0x0002	The chart is resized proportionally to fill the entire page, within page margins.
0x0003	The printed size of the chart is defined in the Chart record.

2.4.205 Prot4Rev

The **Prot4Rev** record specifies whether removal of the [shared workbook's revision logs](#) is disallowed.

0	1	2	3	4	5	6	7	8	9	10	11	12	13	14	15	16	17	18	19	20	21	22	23	24	25	26	27	28	29	30	31
fRevLock																															

fRevLock (2 bytes): A Boolean (section [2.5.14](#)) that specifies whether removal of the shared workbook's revision logs is disallowed. The value MUST be one of the values specified in the following table:

Value	Meaning
0x0000	Removal of the shared workbook's revision logs is allowed.
0x0001	Removal of the shared workbook's revision logs is disallowed.

2.4.206 Prot4RevPass

The **Prot4RevPass** record specifies the password verifier that is required to change the value of the **fRevLock** field of the [Prot4Rev](#) record that immediately precedes this record.

0	1	2	3	4	5	6	7	8	9	10	11	12	13	14	15	16	17	18	19	20	21	22	23	24	25	26	27	28	29	30	31
protPwdRev																															

protPwdRev (2 bytes): An unsigned integer that specifies the password verifier that is required to change the value of the **fRevLock** field of the Prot4Rev record that immediately precedes this record <104>. The algorithm to generate the password verifier is documented in the [password verifier algorithm](#). If the value is 0, there is no password. MUST be 0 if the **fRevLock** field of Prot4Rev is 0x0000.

2.4.207 Protect

The **Protect** record specifies the **protection** state for the **sheet** or **workbook**. If this record exists in the [Globals Substream](#), then the protection state specified in this record applies to the workbook. If this record exists in a [worksheet substream](#), [chart sheet substream](#), [macro sheet substream](#), or [dialog sheet substream](#), then the protection state specified in this record applies to only that sheet. This record MUST exist for the workbook. For a sheet, the sheet is **protected** if and only if this record exists.

0	1	2	3	4	5	6	7	8	9	10	11	12	13	14	15	16	17	18	19	20	21	22	23	24	25	26	27	28	29	30	31
fLock																															

fLock (2 bytes): A Boolean (section [2.5.14](#)) that specifies whether the sheet or workbook is protected. For a sheet, **fLock** MUST be 0x0001, and it means the sheet is protected. For the workbook, it MUST be a value from the following table:

Value	Meaning
0x0000	The workbook is not protected.
0x0001	The workbook is protected.

2.4.208 Qsi

The **Qsi** record specifies properties for a **query table**, and specifies the beginning of a collection of records as defined by the [Worksheet Substream ABNF](#). The collection of records specifies additional information for the query table.

0	1	2	3	4	5	6	7	8	9	10	11	12	13	14	15	16	17	18	19	20	21	22	23	24	25	26	27	28	29	30	31
A	B	C	D	E	F	G	H	I	J	K	L	M	N	itblAutoFmt																	
O	P	Q	R	S	T	unused3							reserved																		
...														rgchName (variable)																	
...																															
unused4																															

A - fTitles (1 bit): A bit that specifies whether the first row of the query table contains column titles.

B - fRowNums (1 bit): A bit that specifies whether the first column of the query table displays row numbers.

C - fDisableRefresh (1 bit): A bit that specifies whether the query table can be refreshed.

Value	Meaning
0	The query table can be refreshed.
1	The query table cannot be refreshed.

D - fAsync (1 bit): A bit that specifies whether the query table refreshes data asynchronously. MUST be set to 1 if **fNewAsync** field is set to 1.

E - fNewAsync (1 bit): A bit that specifies whether data has been refreshed for this query table. MUST be set to 0 if **fAsync** field is set to 0.

Value	Meaning
0	The first background data refresh was finished at the time the file was saved.
1	The first background data refresh was not finished at the time the file was saved.

F - fAutoRefresh (1 bit): A bit that specifies whether the query table refreshes its data automatically when the document is opened.

G - fShrink (1 bit): A bit that specifies the behavior when dealing with a variable number of rows of data in the query table between refresh operations. If **fOverwrite** is 1, this value MUST be 0. MUST be one of the following.

Value	Meaning
0	Unused cells are to be cleared.
1	Unused cells are to be deleted

H - fFill (1 bit): A bit that specifies whether formulas in columns adjacent to the query table are filled down whenever the query table is refreshed.

I - fAutoFormat (1 bit): A bit that is unused and SHOULD be set to zero [<105>](#).

J - fSaveData (1 bit): A bit that specifies whether the query table preserves all of its data in the **sheet** when the document is saved. MUST be one of the following:

Value	Meaning
0x0	Data in the query table will not be saved
0x1	Data in the query table will be saved

K - fDisableEdit (1 bit): A bit that specifies whether the content used with this query table is editable.

Value	Meaning
0	Content is editable
1	Content is locked

L - unused1 (2 bits): Undefined and MUST be ignored.

M - fOverwrite (1 bit): A bit that specifies the behavior when dealing with a variable number of rows of data in the query table between refresh operations. If **fShrink** is 1, this value MUST be 0. MUST be one of the following.

Value	Meaning
0	Insert new cells for new data
1	Overwrite existing cells for new data

N - unused2 (2 bits): Undefined and MUST be ignored.

itblAutoFmt (2 bytes): An [AutoFmt8](#) that specifies the **AutoFormat** to be applied to the query table. MUST be less than or equal to 0x0014.

O - fbitAtrNum (1 bit): A bit that specifies whether numeric cell data is formatted according to the **style** specified in **itblAutoFmt** field.

P - fbitAtrFmt (1 bit): A bit that specifies whether cell text is formatted according to the style specified in **itblAutoFmt** field.

Q - fbitAtrAlc (1 bit): A bit that specifies whether cell text alignment is set according to the style specified in **itblAutoFmt** field.

R - fbitAtrBdr (1 bit): A bit that specifies whether **border** is set according to the style specified in **itblAutoFmt** field.

S - fbitAtrPat (1 bit): A bit that specifies whether the pattern is formatted according to the style specified in **itblAutoFmt** field.

T - fbitAtrProt (1 bit): A bit that specifies whether the cell is **protected** according to the style specified in **itblAutoFmt** field.

unused3 (10 bits): Undefined and MUST be ignored.

reserved (4 bytes): MUST be zero, and MUST be ignored.

rgchName (variable): A [XLUnicodeString](#) string that specifies the name of the query table. The number of characters in this array MUST be less than 0x00FF. Within this [workbook](#), there MUST

be a **defined name** as specified by an [Lbl](#) record with its **fHidden** field equal to 1 and its **Name** field matching this field's value and the **rgce** field only containing a [PtgArea3d](#) referencing the range of cells for the query table fields. Spaces within **rgchName** are converted to underscores for the purposes of this comparison.

unused4 (2 bytes): Undefined and MUST be ignored.

2.4.209 Qsif

The **Qsif** record specifies the properties for a **query table** field. One Qsif record is stored for each query table field.

0	1	2	3	4	5	6	7	8	9	10	11	12	13	14	15	16	17	18	19	20	21	22	23	24	25	26	27	28	29	30	31	
frtHeaderOld																																
A	B	C	iSortKey								D	E	F	G	H	reserved3																
idField																																
idList (optional)																																
rgbTitle (variable)																																
...																																

frtHeaderOld (4 bytes): An [FrtHeaderOld](#) structure. The **frtHeaderOld.rt** field MUST be 0x0807.

A - fUserIns (1 bit): A bit that specifies whether this column was inserted into the query table.

Value	Meaning
0	The column is from the external data source.
1	The column was inserted into the query table and is not from the external data source.

B - fFillDown (1 bit): A bit that specifies whether the formula (section [2.2.2](#)) in this query table field is filled down on data **refresh**.

C - fSortDes (1 bit): A bit that specifies whether this query table field is sorted in **descending order** if it is included as part of a **sort range**.

iSortKey (8 bits): An unsigned integer that specifies the position of this query table field in the sort range. MUST be a value from the following table:

Value	Axis Description
0	This query table field does not contain sort criteria.
1	This query table field contains sort criteria for the first sort key as specified in the Sort record.
2	This query table field contains sort criteria for the second sort key as specified in the Sort record.

Value	Axis Description
3	This query table field contains sort criteria for the third sort key as specified in the Sort record.

D - fRowNums (1 bit): A bit that specifies whether this query table field contains the row numbers for the data from the external data source.

E - reserved1 (1 bit): MUST be zero, and MUST be ignored.

F - fSorted (1 bit): A bit that specifies whether this query table field is part of a sort range.

G - reserved2 (2 bits): MUST be zero, and MUST be ignored.

H - fClipped (1 bit): A bit that specifies whether this query table field is currently outside the **sheet** bounds as specified in the [cell table](#). If the **fUserIns** field is set to 1, this field MUST be set to 0.

reserved3 (15 bits): MUST be zero, and MUST be ignored.

idField (4 bytes): An unsigned integer that specifies a unique identifier of this query table field in the query table. MUST be greater than or equal to 0x0001 and less than or equal to 0xFFFF.

idList (4 bytes): An optional unsigned integer that specifies the value corresponding to the **idList** field of the [TableFeatureType](#) structure that is linked with this query table. This field exists only if the **verLastXLSaved** field of the [BOF](#) records is greater than or equal to 0x4.

rgbTitle (variable): An [XLUnicodeString](#) string that specifies the name of the query table field. The length of the query table field MUST less than or equal to 0x00FF.

2.4.210 Qsir

The **Qsir** record specifies the properties related to the formatting of a **query table**, and specifies the beginning of a collection of **Qsif** records as defined by the [Worksheet Substream ABNF](#). The collection of **Qsif** records specifies properties for a query table field.

One **Qsir** record is stored for each query table

0	1	2	3	4	5	6	7	8	9	10	11	12	13	14	15	16	17	18	19	20	21	22	23	24	25	26	27	28	29	30	31
frtRefHeaderU																															
...																															
...																															
cbQsirSaved																cbQsifSaved															
A	B	C	reserved1													D	E	F	G	H	I	J	wVerBeforeRefr	K							
iSortCustom																															
cQsif																															
cpstDeleted																															

idFieldNext	
ccolExtraLeft	ccolExtraRight
idList (optional)	
rgbTitle (variable)	
...	

frtRefHeaderU (12 bytes): An [FrtRefHeaderU](#) structure. The **frtRefHeaderU.rt** field MUST be 0x0806. The **frtRefHeaderU.grbitFrft.fFrftRef** field MUST be 1 and the **frtRefHeaderU.ref8** field MUST refer to the **range** of **cells** associated with this record.

cbQsirSaved (2 bytes): An unsigned integer that specifies the number of bytes in the Qsir record excluding the **frtRefHeaderU** , **cbQsirSaved**, and **cbQsifSaved** fields.

cbQsifSaved (2 bytes): An unsigned integer that specifies the size in bytes of each Qsif record that follows this Qsir record. This value MUST be less than the difference between the size in bytes for the Qsif record and the size in bytes of the **frtHeaderOld** field in the same record.

A - fPersist (1 bit): A bit that specifies whether sorting, filtering, and layout is preserved for this query table after data **refresh** operations.

B - fPersistSort (1 bit): A bit that specifies whether the sorting is preserved for this query table after data refresh operations. MUST be equal to **fPersist**.

C - fPersistAutoFilter (1 bit): A bit that specifies whether **AutoFilter** is preserved for this query table after data refresh operations. MUST be equal to **fPersist**.

reserved1 (16 bits): MUST be zero, and MUST be ignored.

D - reserved2 (1 bit): MUST be zero, and MUST be ignored.

E - fSorted (1 bit): A bit that specifies whether a **sort** was applied for this query table.

F - fCaseSensSort (1 bit): A bit that specifies whether the sort on the query table is case-sensitive.

G - fHdrRowSort (1 bit): A bit that specifies whether the query table sort accounted for a **header row**.

H - fidWrapped (1 bit): A bit that specifies whether the **idFieldNext** field value has exceeded its upper-bound value (0xFFFF).

I - reserved3 (1 bit): MUST be zero, and MUST be ignored.

J - fTitlesOld (1 bit): A bit that specifies whether the query table had titles the last time it was refreshed.

wVerBeforeRefreshAlert (5 bits): An unsigned integer that specifies the oldest version of the application that is expected to correctly refresh the data in the query table without any errors. MUST be less than or equal to 0x000C. The application version is a value specified in the following table:

Value	Application Version
0x0008	Specifies the application version. <106>
0x0009	Specifies the application version. <107>

Value	Application Version
0x000A	Specifies the application version. <108>
0x000B	Specifies the application version. <109>
0x000C	Specifies the application version. <110>
0x000E	Specifies the application version. <111>
0x000F	Specifies the application version. <112>

K - reserved4 (1 bit): MUST be zero, and MUST be ignored.

iSortCustom (4 bytes): An unsigned integer that specifies the zero-based index of the **custom list** that specifies the **sort order**. The set of custom lists is based on the current user's environment.

For more information about how the set of custom lists is determined, see [\[MSFT-XL2000\]](#).

cQsif (4 bytes): An unsigned integer that specifies the count of Qsif records that immediately follow this Qsir record.

cpstDeleted (4 bytes): An unsigned integer that specifies the number of elements in the **rgbTitle** array.

idFieldNext (4 bytes): An unsigned integer that specifies the next unique number available for assignment to a newly created Qsif record. MUST be greater than or equal to 0x0001 and less than or equal to 0xFFFF.

ccolExtraLeft (2 bytes): A [DCol](#) structure that specifies the number of columns that do not contain **external data** that are included at the beginning of the query table by resizing. When a sort is applied to the query table, they are also applied to these columns.

ccolExtraRight (2 bytes): A [DCol](#) structure that specifies the number of columns that do not contain external data that are included at the end of the query table by resizing. When a sort is applied to the query table, they are also applied to these columns.

idList (4 bytes): An optional unsigned integer that specifies the value corresponding to the **idList** field of the [TableFeatureType](#) structure that is linked with this query table. This field exists only if the **verLastXLSaved** field of the [BOF](#) record is greater than or equal to 0x3.

rgbTitle (variable): An array of [XLUnicodeString](#) structures. This array specifies the names of the database fields in the database **query** that are not included in the query table. The number of elements in this array MUST be equal to the value of the **cpstDeleted** field. The count of characters in each name MUST be greater than or equal to 0x0001 and less than or equal to 0x00FF.

2.4.211 QsiSxTag

The **QsiSxTag** record specifies the name and **refresh** information for a **query table** or a [PivotTable view](#), and specifies the beginning of a collection of records as defined by the [Worksheet Substream ABNF](#). The collection of records specifies additional information for a query table or a PivotTable view.

If **fSx** is 0 and **stName** is equal to the **rgchName** field of a [Qsi](#) record in this worksheet substream, then this collection of records applies to the query table that the Qsi record is associated with. If **fSx** is 1 and **stName** is equal to the **stName** field of an [SxView](#) record in this worksheet substream, then this collection of records applies to the PivotTable view that the SxView record is associated with and its [associated PivotCache](#). Otherwise, this collection of records MUST be ignored.

0	1	2	3	4	5	6	7	8	9	10	11	12	13	14	15	16	17	18	19	20	21	22	23	24	25	26	27	28	29	30	31			
frtHeaderOld																																		
fSx																A	B	C	reserved1															
dwQsiFuture																																		
verSxLastUpdated								verSxUpdatableMin								obCchName								reserved2										
stName (variable)																																		
...																																		
unused																																		

frtHeaderOld (4 bytes): An [FrtHeaderOld](#) structure. The **frtHeaderOld.rt** field MUST be 0x0802.

fSx (2 bytes): A Boolean (section [2.5.14](#)) that specifies whether this record relates to a PivotTable view or a query table.

Value	Meaning
0x0000	Specifies that this record relates to a query table.
0x0001	Specifies that this record relates to a PivotTable view.

A - fEnableRefresh (1 bit): A bit that specifies whether refresh of the PivotTable view or query table is enabled. MUST be 0 if **fSx** is 1 and the [PivotCache functionality level](#) of the associated PivotCache is greater than or equal to 3.

Value	Value of fSx	Meaning
0	0	Whether refresh of the query table is enabled is specified by the fDisableRefresh field of the associated Qsi record.
0	1	Whether refresh of the associated PivotCache is enabled is specified by the fEnableRefresh field in the SXDB record of the PivotCache .
1	0	Specifies that refresh of the query table is enabled.
1	1	Specifies that refresh of the associated PivotCache is enabled.

B - fInvalid (1 bit): A bit that specifies the invalid state of the [cache records](#) of the associated PivotCache; see Cache Records for more information. MUST be 1 if **fSx** is 1 and the PivotCache functionality level of the associated PivotCache is greater than or equal to 3.

C - fTensorEx (1 bit): A bit that specifies whether the PivotTable view is an [OLAP PivotTable view](#). MUST be equal to 0 if fSx is 0.

reserved1 (13 bits): MUST be zero, and MUST be ignored.

dwQsiFuture (4 bytes): This structure specifies additional option flags for a query table or a PivotTable view depending on the value of the **fSx** field.

Value of fSx Field	Type of dwQsiFuture
0x0000	DwQsiFuture
0x0001	SXView9Save

verSxLastUpdated (1 byte): A [DataFunctionalityLevel](#) value that specifies the [data functionality level](#) that the PivotTable view was last refreshed with. MUST be 0 if this record relates to a query table.

verSxUpdatableMin (1 byte): A DataFunctionalityLevel value that specifies the minimum version of the application that can recalculate the PivotTable view. MUST be 0x00 or 0x03. MUST be 0 if this record is for a query table. MUST be 3 if the PivotCache functionality level of the associated PivotCache is 3.

obCchName (1 byte): MUST be 0x10, and MUST be ignored.

reserved2 (1 byte): MUST be zero, and MUST be ignored.

stName (variable): An [XLUnicodeString](#) structure that specifies the query table or PivotTable view name.

unused (2 bytes): Undefined and MUST be ignored.

2.4.212 Radar

The **Radar** record specifies that the [chart group](#) is a radar chart group and specifies the chart group attributes.

0	1	2	3	4	5	6	7	8	9	10	11	12	13	14	15	16	17	18	19	20	21	22	23	24	25	26	27	28	29	30	31
A	B	reserved														unused															

A - fRdrAxLab (1 bit): A bit that specifies whether **category (2)** labels are displayed.

B - fHasShadow (1 bit): A bit that specifies whether one or more **data markers** in the chart group has shadows.

reserved (14 bits): MUST be zero, and MUST be ignored.

unused (2 bytes): Undefined and MUST be ignored.

2.4.213 RadarArea

The **RadarArea** record specifies that the [chart group](#) is a filled radar chart group and specifies the chart group attributes.

0	1	2	3	4	5	6	7	8	9	10	11	12	13	14	15	16	17	18	19	20	21	22	23	24	25	26	27	28	29	30	31
A	B	reserved														unused															

A - fRdrAxLab (1 bit): A bit that specifies whether **category (2)** labels are displayed.

B - fHasShadow (1 bit): A bit that specifies whether the [data points](#) in the chart group have shadows.

reserved (14 bits): MUST be zero, and MUST be ignored.

unused (2 bytes): Undefined and MUST be ignored.

2.4.214 RealTimeData

The **RealTimeData** record specifies the **real-time data (RTD)** information for a **workbook**.

There is one RealTimeData record for each **RTD topic** in the workbook.

0	1	2	3	4	5	6	7	8	9	10	11	12	13	14	15	16	17	18	19	20	21	22	23	24	25	26	27	28	29	30	31
frtHeader																															
...																															
...																															
ichSamePrefix																															
stTopic (variable)																															
...																															
rtdOper (variable)																															
...																															
rgRTDE (variable)																															
...																															

frtHeader (12 bytes): An [FrtHeader](#) structure. The **frtHeader.rt** field MUST be 0x0813.

ichSamePrefix (4 bytes): An unsigned integer that specifies the number of leading characters in common with the **stTopic** string in the previous RealTimeData record. MUST be 0 if there is no prefix in common or if this is the first RealTimeData record.

stTopic (variable): An [XLUnicodeStringSegmentedRTD](#) structure that specifies the string for the RTD topic specified by this record. The string can be stored in a compressed or uncompressed format. When **ichSamePrefix** is greater than 0, this string does not include any leading characters that are in common with the **stTopic** string in the previous RealTimeData record. The first substring specifies the **ProgID** of the **RTD server**. The second substring specifies the **server**

name that the RTD server is running on or, if this substring is empty, specifies that the RTD server is running locally. The rest of the substrings are combined to form a unique RTD topic.

rtDOper (variable): An [RTDOper](#) structure that specifies the data returned by the RTD server.

rgRTDE (variable): An array of [RTDEItem](#) structures that specifies the set of **cells** associated with the RTD topic. The length of the array is specified by the following formula:

$$\text{Array length} = (\text{size of this record and associated } \text{ContinueFr} \text{ records} - 16 - \text{size of } \text{stTopic} - \text{size of } \text{rtDOper}) / 6$$

2.4.215 RecalcId

The **RecalcId** record specifies the identifier of the recalculation engine that performed the last recalculation.

0	1	2	3	4	5	6	7	8	9	10	11	12	13	14	15	16	17	18	19	20	21	22	23	24	25	26	27	28	29	30	31
rt																reserved															
dwBuild																															

rt (2 bytes): An unsigned integer that specifies the record identifier. MUST be 449.

reserved (2 bytes): MUST be zero, and MUST be ignored.

dwBuild (4 bytes): An unsigned integer that specifies the identifier of the recalculation engine that performed the last recalculation. If the value is less than the recalculation engine identifier associated with the application, the application will **recalculate** the results of all formulas on this **workbook** immediately after loading the file.

2.4.216 RecipName

The **RecipName** record specifies information about a recipient of a [routing slip<113>](#).

0	1	2	3	4	5	6	7	8	9	10	11	12	13	14	15	16	17	18	19	20	21	22	23	24	25	26	27	28	29	30	31
cchRecip																uLEIDSize															
...																szFriendly (variable)															
...																															
rgchSSAddr (variable)																															
...																															

cchRecip (2 bytes): An unsigned integer that specifies the count of characters in the **szFriendly** field string. MUST be less than or equal to 256.

uLEIDSize (4 bytes): An unsigned integer that specifies the count of characters in the **rgchSSAddr** field string.

szFriendly (variable): A NULL-terminated array of ANSI characters that specifies the recipient's **friendly name**. The length of the string MUST be specified by the **cchRecip** field.

rgchSSAddr (variable): An array of ANSI characters whose length is specified by the **ulEIDSize** field that specifies the identifier used by the **messaging system service provider** to identify the recipient.

2.4.217 RefreshAll

The **RefreshAll** record specifies whether **external data** ranges, **PivotTables** and **XML maps** will be refreshed on **workbook** load.

0	1	2	3	4	5	6	7	8	9	10	1	2	3	4	5	6	7	8	9	20	1	2	3	4	5	6	7	8	9	30	1
refreshAll																															

refreshAll (2 bytes): A Boolean (section 2.5.14) that specifies whether to force **refresh** of external data ranges, PivotTables and XML maps on workbook load. MUST be a value from the following table:

Value	Meaning
0x0001	Force refresh of external data ranges, PivotTables and XML maps on workbook load.
0x0000	Do not force refresh of external data ranges, PivotTables and XML maps on workbook load.

MUST be 0x0000 if workbook is not a **template**.

2.4.218 RichTextStream

The **RichTextStream** record specifies additional text properties for the text in the entire **chart**, text in the current **legend**, text in the current **legend entry**, or text in the **attached label**. These text properties are a superset of the properties stored in the **Text**, **Font**, **FontX**, **BRAI**, and **ObjectLink** records based on the following table, as specified by the **Chart Sheet Substream ABNF**. In each case, the associated Font record is specified by the associated FontX record. [<114>](#)

Rule Containing the RichTextStream record	Meaning
CHARTFORMATS	<p>Specifies additional Rich Text Format properties for the text of the entire chart.</p> <p>The associated Text and FontX records are contained in the attached label that is contained in the first sequence of records that conforms to the DFTTEXT rule in the chart, and not contained in the chart group.</p>
LD	<p>Specifies additional Rich Text Format properties for text in the current legend.</p> <p>The associated Text and FontX records are contained in the sequence of records that conforms to the ATTACHEDLABEL rule that is contained in the sequence of records that conforms to the LD rule.</p>

Rule Containing the RichTextStream record	Meaning
SERIESFORMAT	<p>Specifies additional Rich Text Format properties for the current legend entry.</p> <p>The associated Text and FontX records are contained in the sequence of records that conforms to the ATTACHEDLABEL rule that immediately precedes this record in the sequence of records that conforms to the SERIESFORMAT rule.</p> <p>The associated BRAI record is contained in the sequence of records that conforms to the AI rule that is contained in the sequence of records that conforms to the SERIESFORMAT rule.</p>
ATTACHEDLABEL	<p>Specifies additional Rich Text Format properties for the text in the attached label.</p> <p>The associated Text and FontX records are contained in the sequence of records that conforms to the ATTACHEDLABEL rule.</p> <p>The associated BRAI record is contained in the sequence of records that conforms to the ATTACHEDLABEL rule.</p> <p>The associated ObjectLink record is contained in the sequence of records that conforms to the ATTACHEDLABEL rule.</p>

These Rich Text Format properties are stored in the **XML stream** (section [2.1.7.22](#)) specified in [\[ECMA-376\]](#) Part 4, section 5.7.2.217.

An application can choose to ignore this record without loss of functionality, but will lose access to the additional Rich Text Format properties. If an application chooses to implement this record, the application **MUST** implement the validation **checksum** specified by the **dwChecksum** field.

0	1	2	3	4	5	6	7	8	9	10	11	12	13	14	15	16	17	18	19	20	21	22	23	24	25	26	27	28	29	30	31
frtHeader																															
...																															
...																															
dwChecksum																															
cb																															
rgb (variable)																															
...																															

fmtHeader (12 bytes): An [FmtHeader](#) structure. The **fmtHeader.rt** field MUST be 0x08A6.

dwChecksum (4 bytes): An unsigned integer that specifies the checksum of the attributes of the Rich Text Format properties related to this record. The algorithm used to calculate the checksum is specified by [\[MS-OSHARED\]](#) section 2.4.3.2. The checksum MUST be calculated from every property of the **property stream**, taken as an array of bytes as specified by the [RichTextStreamChecksumData](#) structure.

The information required to build the memory stream can be gathered from the Text, FontX, Font, BRAI, and ObjectLink records associated with this record, as previously specified.

When reading this record, the checksum is calculated as previously specified and compared to the **dwChecksum** value stored in this record. If the calculated checksum does not match the **dwChecksum** data, the application MUST assume that the **XML stream** (section 2.1.7.22) is out of date, and the data from the associated records MUST be used instead of the data specified by the **XML stream** (section 2.1.7.22).

cb (4 bytes): An unsigned integer that specifies the size of the **rgb** field. This field MUST contain the exact length in bytes of the **rgb** field.

rgb (variable): An array of ANSI characters that contains the **XML** representation of the text formatting properties, as defined in [\[ECMA-376\]](#) Part 4, section 5.7.2.217. The length of this field is specified by the **cb** field.

2.4.219 RightMargin

The **RightMargin** record specifies the right margin of the current **sheet**.

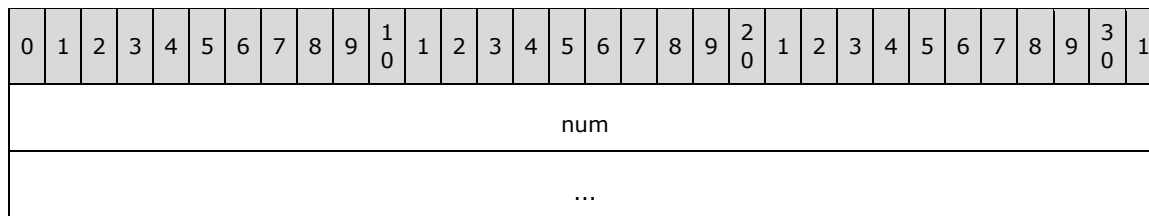

num (8 bytes): An Xnum (section [2.5.342](#)) value that specifies the right margin of the current sheet in inches. The value MUST be greater than or equal to 0 and less than or equal to 49.

2.4.220 RK

The **RK** record specifies the numeric data contained in a single **cell**.

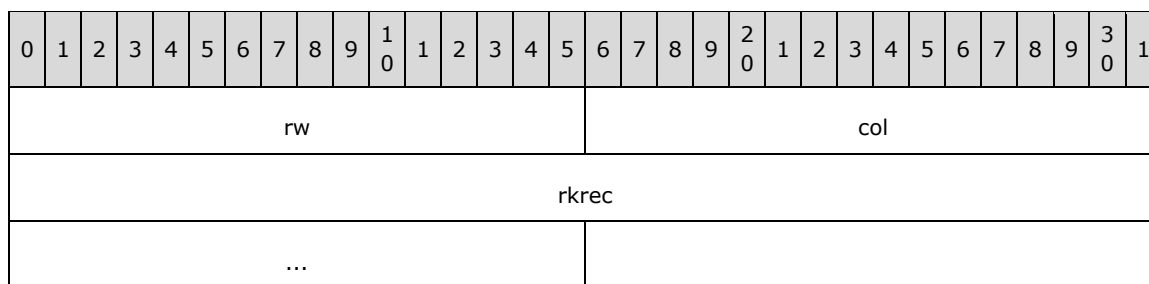

rw (2 bytes): An [Rw](#) structure that specifies a row index.

col (2 bytes): A [Col](#) structure that specifies a column index.

rkrec (6 bytes): An [RkRec](#) structure that specifies the numeric data for a single cell.

2.4.221 Row

The **Row** record specifies a single row on a **sheet**.

0	1	2	3	4	5	6	7	8	9	10	11	12	13	14	15	16	17	18	19	20	21	22	23	24	25	26	27	28	29	30	31
rw																colMic															
colMac																miyRw															
reserved1																unused1															
A	B	C	D	E	F	reserved3										ixfe_val										G	H	I	J		

rw (2 bytes): An [Rw](#) structure that specifies the row index.

colMic (2 bytes): An unsigned integer that specifies the zero-based index of the first column that contains a **cell** populated with data or formatting in the current row. MUST be less than or equal to 255.

colMac (2 bytes): An unsigned integer that specifies the one-based index of the last column that contains a cell populated with data or formatting in the current row. MUST be less than or equal to 256. If **colMac** is equal to **colMic**, this record specifies a row with no [CELL](#) records.

miyRw (2 bytes): An unsigned integer that specifies the row height in **twips**. If **fDyZero** is 1, the row is **hidden** and the value of **miyRw** specifies the original row height. MUST be greater than or equal to 2 and MUST be less than or equal to 8192.

reserved1 (2 bytes): MUST be zero, and MUST be ignored.

unused1 (2 bytes): Undefined and MUST be ignored.

A - iOutLevel (3 bits): An unsigned integer that specifies the **outline level** of the row.

B - reserved2 (1 bit): MUST be zero, and MUST be ignored.

C - fCollapsed (1 bit): A bit that specifies whether the rows that are one level of outlining deeper than the current row are included in the **collapsed outline state**.

D - fDyZero (1 bit): A bit that specifies whether the row is hidden.

E - fUnsynced (1 bit): A bit that specifies whether the row height was manually set.

F - fGhostDirty (1 bit): A bit that specifies whether the row was formatted.

reserved3 (1 byte): MUST be 1, and MUST be ignored.

ixfe_val (12 bits): An unsigned integer that specifies an [XF](#) record for the row formatting. See [IXFCell](#) for more information. If **fGhostDirty** is 0, **ixfe_val** is undefined and MUST be ignored.

G - fExAsc (1 bit): A bit that specifies whether any cell in the row has a thick top **border**, or any cell in the row directly above the current row has a thick bottom border. Thick borders are specified by the following enumeration values from [BorderStyle](#): **THICK** and **DOUBLE**.

H - fExDes (1 bit): A bit that specifies whether any cell in the row has a medium or thick bottom border, or any cell in the row directly below the current row has a medium or thick top border. Thick borders are previously specified. Medium borders are specified by the following enumeration

values from BorderStyle: **MEDIUM**, **MEDIUMDASHED**, **MEDIUMDASHDOT**, **MEDIUMDASHDOTDOT**, and **SLANTDASHDOT**.

I - fPhonetic (1 bit): A bit that specifies whether the **phonetic guide** feature is enabled for any cell in this row.

J - unused2 (1 bit): Undefined and MUST be ignored.

2.4.222 RRAutoFmt

The **RRAutoFmt** record specifies the changes caused by **AutoFormat** actions in a [shared workbook](#).

0	1	2	3	4	5	6	7	8	9	10	11	12	13	14	15	16	17	18	19	20	21	22	23	24	25	26	27	28	29	30	31
rrd (14 bytes)																															
...																															
...																															
...																ref8															
...																															
...																itbl															
A	B	C	D	E	F	reserved																									

rrd (14 bytes): An [RRD](#) structure that specifies the [revision record](#) information used to track changes in a shared workbook. The **rrd.revid** MUST be 0 because this is a **revision** that cannot be reviewed. The **rrd.rev** MUST be equal to 0x000C. The **rrd.tabid** MUST NOT be 0xFFFF because this revision corresponds to a specific **sheet**.

ref8 (8 bytes): A [Ref8U](#) structure that specifies the **range** of cells affected by AutoFormat changes.

itbl (2 bytes): An [AutoFmt8](#) structure that specifies which AutoFormat was applied.

A - fApplyNumberFormats (1 bit): A bit that specifies whether the **number format** properties contained in the AutoFormat specified by **itbl** were applied.

B - fApplyFontFormats (1 bit): A bit that specifies whether the **font** properties contained in the AutoFormat specified by **itbl** were applied.

C - fApplyAlignmentFormats (1 bit): A bit that specifies whether the text alignment properties contained in the AutoFormat specified by **itbl** were applied.

D - fApplyBorderFormats (1 bit): A bit that specifies whether the **border** properties contained in the AutoFormat specified by **itbl** were applied.

E - fApplyPatternFormats (1 bit): A bit that specifies whether the color pattern properties contained in the AutoFormat specified by **itbl** were applied.

F - fApplyWidthHeightFormats (1 bit): A bit that specifies whether the width or height properties contained in the AutoFormat specified by **itbl** were applied.

reserved (10 bits): MUST be zero, and MUST be ignored.

2.4.223 RRDChgCell

The **RRDChgCell** record specifies a [change cells revision](#).

0	1	2	3	4	5	6	7	8	9	10	11	12	13	14	15	16	17	18	19	20	21	22	23	24	25	26	27	28	29	30	31
rrd (14 bytes)																															
...																															
...																															
...																vt	vtOld	A	B	C	D	E	F	G	H	I					
ifmtDisp								J	K	L	reserved2				loc																
...																cbOldVal															
...																cetxpRst															
dxfoId (variable)																															
...																															
dxfo (variable)																															
...																															
rkOld (optional)																															
numOld (optional)																															
...																															
stOld (variable)																															
...																															
besOld (optional)																xpeOld (variable)															
...																															
rk (optional)																															
num (optional)																															
...																															
st (variable)																															

...	
bes (optional)	xpe (variable)
...	

rrd (14 bytes): An [RRD](#) structure that specifies the [revision record](#) information used to track changes in a [shared workbook](#). Because this **revision** corresponds to a specific **sheet**, **rrd.rev** MUST be 0x0008, **rrd.fDelAtEdgeOfSort** MUST be 0x0000, **rrd.revid** MUST be greater than or equal to 0, and **rrd.tabid** MUST NOT be 0xFFFF.

vt (3 bits): An unsigned integer that specifies the type of the new **cell** contents. MUST be a value from the following table:

Value	Meaning
0x0	New cell is blank.
0x1	New cell contains an RkNumber value.
0x2	New cell contains an Xnum (section 2.5.342) value.
0x3	New cell contains an XLUnicodeRichExtendedString value.
0x4	New cell contains a Bes value.
0x5	New cell contains a CellParsedFormula value.

vtOld (3 bits): An unsigned integer that specifies the type of the old cell contents. MUST be a value from the following table:

Value	Meaning
0x0	Old cell is blank.
0x1	Old cell contains an RkNumber value.
0x2	Old cell contains an Xnum value.
0x3	Old cell contains an XLUnicodeRichExtendedString value.
0x4	Old cell contains a Bes value.
0x5	Old cell contains a CellParsedFormula value.

A - f123Prefix (1 bit): A bit that specifies whether prefix characters are present in the cell. Possible prefix characters include single quotation mark (0x27), double quotation mark (0x22), caret (0x5E), and backslash (0x5C).

B - unused (1 bit): Undefined and MUST be ignored.

C - fOldFmt (1 bit): A bit that specifies whether there is old formatting information available for this cell. If **fOldFmt** is 0x1 and **fOldFmtNull** is 0x0, **dxFOld** MUST exist.

D - fOldFmtNull (1 bit): A bit that specifies whether the old formatting information is empty. This value MUST be ignored if **fOldFmt** is 0. If **fOldFmt** is 0x1 and **fOldFmtNull** is 0x0, **dxFOld** MUST exist. If **fOldFmt** is 0x1 and **fOldFmtNull** is 0x1, old formatting information is available for the cell, but the old formatting information is not written to disk and **dxFOld** MUST NOT exist.

E - fXfDxf (1 bit): A bit that specifies that the affected cells will have their format reset to the format defined by the current [cell style](#) before applying any format from **dx**f, if present.

F - fStyXfDxf (1 bit): A bit that specifies that the format of the cell will be cleared before applying any format from **dx**f, if present.

G - fDxf (1 bit): A bit that specifies whether there was a formatting change for this cell. If **fDxf** is 0x1 and **fDxfNull** is 0x0, **dx**f MUST exist.

H - fDxfNull (1 bit): A bit that specifies whether the new formatting information is empty. This value MUST be ignored if **fDxf** is 0. If **fDxf** is 0x1 and **fDxfNull** is 0x0, **dx**f MUST exist. If **fDxf** is 0x1 and **fDxfNull** is 0x1, this means that there was a formatting change for this cell, but the **dx**f describing the formatting change MUST NOT exist.

I - reserved1 (2 bits): MUST be zero, and MUST be ignored.

ifmtDisp (8 bits): An unsigned integer that specifies the identifier of the **number format** to use to display the new cell contents. MUST be a value from the following table. For more information about how **format strings** are interpreted, see [\[ECMA-376\]](#) Part 4: Markup Language Reference, section 3.8.31.

Value	Description	Positive Value Format	Negative Value Format	Zero Format
0x0000	Automatic	0	-0	0
0x0004	Number, two decimal places, use the 1000 separator (,)	#,###0.00	-#,###0.00	0.00
0x000B	Currency, two decimal places, use parentheses for negative values	\$#,###0.00	(\$#,###0.00)	\$0.00
0x000D	Percentage, zero decimal places	0%	-0%	0%
0x000E	Percentage, two decimal places	0.00%	-0.00%	0.00%
0x000F	Scientific	0.00E+00	-0.00E+00	0.00E+00
0x0010	Engineering	##0.0E+0	-##0.0E+0	0.0E+0
0x0011	Fraction, up to one digit numerator and denominator	# ?/?	-# ?/?	0
0x0012	Fraction, up to two digit numerator and denominator	# ??/??	-# ??/??	0
0x0013	Date (MM-DD-YY)	mm-dd-yy	mm-dd-yy	
0x0015	Date (DD-MMM)	d-mmm	d-mmm	
0x0017	Time (H:MM AM/PM)	h:mm AM/PM	h:mm AM/PM	
0x001B	Date/Time, 24 hour format (M/D/YY H:MM)	m/d/yy h:mm	m/d/yy h:mm	
0x0022	Accounting (currency with decimal point aligned, and centered minus-sign for 0-value), two decimal places, use currency symbol	_\$* #,###0.00_	_\$* #,###0.00	_\$* "-" ??_

J - fPhShow (1 bit): A bit that specifies whether the new cell contains a **phonetic string**.

K - fPhShowOld (1 bit): A bit that specifies whether the old cell contains a phonetic string.

L - fEOLFmlaUpdate (1 bit): A bit that specifies whether the new cell contents were changed because of an adjustment to the formula.

reserved2 (5 bits): MUST be zero, and MUST be ignored.

loc (4 bytes): An [RqceLoc](#) structure that specifies the location of the cell change revision.

cbOldVal (4 bytes): An unsigned integer that specifies the size of the old cell contents. If **cbOldVal** is greater than 0, the old cell contents immediately follow the **cetxpRst** field, then it is followed by the new cell contents. MUST be a value from the following table based on the value of **vtOld**:

vtOld	cbOldVal

vtOld	cbOldVal
0x0	MUST be 0x00000000.
0x1	MUST be 0x00000004.
0x2	MUST be 0x00000008.
0x3	MUST be equal to the size of the old XLUnicodeRichExtendedString. The size is calculated assuming all characters are double-byte characters. That is, if XLUnicodeRichExtendedString.fHighByte is 1, the calculation is made by using the size of XLUnicodeRichExtendedString.
0x4	MUST be 0x00000002.
0x5	MUST be greater than or equal to 0x00000018.

cetxpRst (2 bytes): An unsigned integer that specifies the number of [RRDRstEtxp](#) records that follow this record.

dxfoId (variable): A [DXFN](#) structure that specifies the [differential formatting](#) for the old cell contents. This field MUST exist if **fOldFmt** is 0x1 and **fOldFmtNull** is 0x0.

dxfo (variable): A DXFN structure that specifies the differential formatting for the new cell contents. This field MUST exist if **fDxf** is 0x1 and **fDxfNull** is 0x0.

rkOld (4 bytes): An RkNumber structure that specifies the old cell contents. This field MUST exist if and only if **cbOldVal** is greater than 0 and **vtOld** is 0x1.

numOld (8 bytes): An Xnum value that specifies the old cell contents. This field MUST exist if and only if **cbOldVal** is greater than 0 and **vtOld** is 0x2.

stOld (variable): An XLUnicodeRichExtendedString structure that specifies the old cell contents. This field MUST exist if and only if **cbOldVal** is greater than 0 and **vtOld** is 0x3.

besOld (2 bytes): A Bes structure that specifies the old cell contents. This field MUST exist if and only if **cbOldVal** is greater than 0 and **vtOld** is 0x4.

xpeOld (variable): A CellParsedFormula structure that specifies the old cell contents. This field MUST exist if and only if **cbOldVal** is greater than 0 and **vtOld** is 0x5.

rk (4 bytes): An RkNumber value that specifies the new cell contents. This field MUST exist if and only if **vt** is 0x1.

num (8 bytes): An Xnum value that specifies the new cell contents. This field MUST exist if and only if **vt** is 0x2.

st (variable): An XLUnicodeRichExtendedString structure that specifies the new cell contents. This field MUST exist if and only if **vt** is 0x3.

bes (2 bytes): A Bes structure that specifies the new cell contents. This field MUST exist if and only if **vt** is 0x4.

xpe (variable): A CellParsedFormula structure that specifies the new cell contents. This field MUST exist if and only if **vt** is 0x5.

2.4.224 RRDConflict

The **RRDConflict** record specifies the resolution of a conflict between the revisions of two uses'.

0	1	2	3	4	5	6	7	8	9	10	11	12	13	14	15	16	17	18	19	20	21	22	23	24	25	26	27	28	29	30	31
rrd (14 bytes)																															
...																															
...																															
...																															

rrd (14 bytes): An [RRD](#) structure that specifies the [revision record](#) information used to track changes in a [shared workbook](#). The **rrd.revid** MUST be greater than 0. The **rrd.revid** identifies the **revision** that won the conflict. The **rrd.rev** MUST be equal to [revtConflict](#).

2.4.225 RRDefName

The **RRDefName** record specifies a **defined name** revision.

0	1	2	3	4	5	6	7	8	9	10	11	12	13	14	15	16	17	18	19	20	21	22	23	24	25	26	27	28	29	30	31
rrd (14 bytes)																															
...																															
...																															
...																tabidLocal															
fViewName								reserved								grbit															
...																															
grbitOld																															
...																builtinIndex								unused (optional)							
...																stDefName (variable)															
...																															
pe (variable)																															
...																															
stCustomMenu (variable)																															
...																															
stDescription (variable)																															

...
stHelpTopic (variable)
...
stStatusText (variable)
...
peOld (variable)
...
stCustomMenuOld (variable)
...
stDescriptionOld (variable)
...
stHelpTopicOld (variable)
...
stStatusTextOld (variable)
...

rrd (14 bytes): An [RRD](#) structure that specifies the [revision record](#) information used to track changes in a [shared workbook](#). The **revt** field of the RRD structure MUST be 0x000A or 0x0022. The **fDelAtEdgeOfSort** field of the RRD structure MUST be 0x0000. The **revid** field of the RRD structure MUST be greater than or equal to 0.

tabidLocal (2 bytes): A [TabId](#) structure that specifies the **sheet** containing the defined name. A value of 0xFFFF specifies that the defined name is not a **local name**.

fViewName (1 byte): A Boolean (section [2.5.14](#)) that specifies whether the defined name belongs to a **custom view**. MUST be a value from the following table:

Value	Meaning
0x00	The defined name does not belong to a custom view.
0x01	The defined name belongs to a custom view.

reserved (1 byte): MUST be zero, and MUST be ignored.

grbit (6 bytes): An [RRDDefNameFlags](#) structure that specifies data for the new defined name.

grbitOld (6 bytes): An [RRDDefNameFlags](#) structure that specifies data for the old defined name.

builtinIndex (1 byte): An unsigned integer that specifies the identifier of a built-in name. MUST be a value from the following table:

Identifier	Built-in Name
0x00	Not a built-in name
0x01	"Consolidate_Area"
0x02	"Auto_Open"
0x03	"Auto_Close"
0x04	"Extract"
0x05	"Database"
0x09	"Recorder"
0x0A	"Data_Form"
0x0B	"Auto_Activate"
0x0C	"Auto_Deactivate"
0x0D	"Sheet_Title"

unused (3 bytes): Optional, undefined, and MUST be ignored. MUST exist if and only if **builtinIndex** is not equal to 0.

stDefName (variable): An [XLUnicodeString](#) structure that specifies the defined name. MUST exist if and only if **builtinIndex** is equal to 0. MUST be less than or equal to 255 characters. MUST begin with a letter or underscore character.

pe (variable): A [NameParsedFormula](#) structure that specifies the formula (section [2.2.2](#)) of the new defined name. The length of the formula in bytes is specified by **grbit.cce**.

stCustomMenu (variable): An [XLUnicodeString](#) structure that specifies the new custom menu text.

stDescription (variable): An [XLUnicodeString](#) structure that specifies the new description text.

stHelpTopic (variable): An [XLUnicodeString](#) structure that specifies the new help text.

stStatusText (variable): An [XLUnicodeString](#) structure that specifies the new status bar text.

peOld (variable): A [NameParsedFormula](#) structure that specifies the formula of the old defined name. The length of the formula in bytes is specified by **grbitOld.cce**.

stCustomMenuOld (variable): An [XLUnicodeString](#) structure that specifies the old custom menu text.

stDescriptionOld (variable): An [XLUnicodeString](#) structure that specifies the old description text.

stHelpTopicOld (variable): An [XLUnicodeString](#) structure that specifies the old help text.

stStatusTextOld (variable): An [XLUnicodeString](#) structure that specifies the old status bar text.

2.4.226 RRDHead

The **RRDHead** record specifies metadata about a set of revisions that a user has made in a [shared workbook](#).

0	1	2	3	4	5	6	7	8	9	10	11	12	13	14	15	16	17	18	19	20	21	22	23	24	25	26	27	28	29	30	31
rrd (14 bytes)																															
...																															
...																															
...																guid (16 bytes)															
...																															
...																															
...																wFileCodePage															
cchUser																stUser (114 bytes)															
...																															
...																															
...																															
sddtr																															
...																															
tabidMac																															

rrd (14 bytes): An [RRD](#) structure that specifies the [revision record](#) information used to track changes in a shared workbook. The **rrd.revnt** MUST be equal to 0x0020. The **rrd.cbMemory** MUST be equal to 0xFFFFFFFF and MUST be ignored. The **rrd.revid** MUST be 0 because this is a **revision** that cannot be reviewed.

guid (16 bytes): A **GUID** as specified by [\[MS-DTYP\]](#) that specifies a unique identifier for this set of revisions.

wFileCodePage (2 bytes): An unsigned integer that specifies the **sheet's code page**. The value MUST be one of the code page values specified in [\[CODEPG\]](#) or the special value 1200, which means that the sheet is **Unicode**.

cchUser (2 bytes): An unsigned integer that specifies the number of characters in **stUser** that are used to specify the name of the user who made this set of revisions. Characters in **stUser** that are to the right of these used characters are ignored. The value of **cchUser** MUST be less than or equal to 54.

stUser (114 bytes): An [XLUnicodeStringNoCch](#) structure that specifies the name of the user who made this set of revisions.

sddtr (8 bytes): A [ShortDTR](#) structure that specifies the date and time when the user saved this set of revisions.

tabidMac (2 bytes): A signed integer that specifies the next available sheet identifier in this **workbook**. The value MUST be greater than or equal to -1. Each sheet identifier is specified by the order in which the [BoundSheet8](#) records appear in the [Globals Substream](#).

2.4.227 RRDInfo

The **RRDInfo** record specifies information about a [shared workbook](#).

0	1	2	3	4	5	6	7	8	9	10	11	12	13	14	15	16	17	18	19	20	21	22	23	24	25	26	27	28	29	30	31									
wXLVer																reserved1																								
A	B	C	D	E	reserved2											guid (16 bytes)																								
...																																								
...																																								
...																guidRoot (16 bytes)																								
...																																								
...																																								
...																revid																								
...																version																								
...																F	G	reserved3																						
wRevHistoryInterval																																								

wXLVer (2 bytes): An unsigned integer that specifies the major **BIFF** version that was last used to save a shared workbook.

reserved1 (2 bytes): MUST be zero, and MUST be ignored.

A - fssShared (1 bit): A bit that specifies whether this **workbook** is a shared workbook. If this value is 1, **fssExclusive** MUST be equal to 0.

B - fssDiskHasRev (1 bit): A bit that specifies whether the **revision history** on disk contains revisions. If this value is 1, **fssRevTrack** MUST be equal to 1.

C - fssRevHist (1 bit): A bit that specifies whether revisions are automatically deleted. If this value is 1, **fssRevTrack** MUST be equal to 1. MUST be a value from the following table:

Value	Meaning
0	Revisions are not automatically deleted.
1	Revisions are automatically deleted.

D - fssRevTrack (1 bit): A bit that specifies whether the revisions are being tracked. If this value is 1, **fssShared** MUST be equal to 1.

E - fssExclusive (1 bit): A bit that specifies whether this workbook is in exclusive mode. Exclusive mode means the workbook was shared when revisions were made, but it is no longer shared. If this value is 1, **fssShared** MUST be equal to 0.

reserved2 (11 bits): MUST be zero, and MUST be ignored.

guid (16 bytes): A **GUID** as specified by [\[MS-DTYP\]](#) that specifies the last set of revisions. MUST be 0, or MUST match the GUID for the most recent header.

guidRoot (16 bytes): A GUID as specified by [\[MS-DTYP\]](#) that specifies the last set of revisions that was saved to the file. MUST be 0, or MUST match the GUID for one of the **revision** headers.

revid (4 bytes): A signed integer that specifies the current revision number of this shared workbook. This identifier is used to track the order of [revision records](#). MUST be greater than or equal to 0.

version (4 bytes): An unsigned integer that specifies the current version of this shared workbook.

F - fNoRevHist (1 bit): A bit that specifies whether this workbook preserves revision history. If this value is 1, **wRevHistoryInterval** MUST be equal to 0 and **fssShared** MUST be equal to 1. If this value is 0, **wRevHistoryInterval** MUST be greater than or equal to 1.

G - fProtRev (1 bit): A bit that specifies whether the revision history is **protected** for this shared workbook. If this value is 1, **fssShared** MUST be equal to 1.

reserved3 (14 bits): MUST be zero, and MUST be ignored.

wRevHistoryInterval (2 bytes): An unsigned integer that specifies the number of days for which the revision history is stored for this workbook. MUST be less than or equal to 0x7FFF. If **fssExclusive** is equal to 1, this field MUST be ignored.

2.4.228 RRDInsDel

The **RRDInsDel** record specifies the [insertion / deletion of rows / columns revision](#) changes, and specifies the beginning of a collection of records as defined by the [Revision Stream ABNF](#). The collection of records specifies insertions and deletions in a [shared workbook](#).

0	1	2	3	4	5	6	7	8	9	10	11	12	13	14	15	16	17	18	19	20	21	22	23	24	25	26	27	28	29	30	31
rrd (14 bytes)																															
...																															
...																															
...																A	reserved														
refn																															
...																															
cUcr																															

rgDucr (variable)
...

rrd (14 bytes): An [RRD](#) structure that specifies the [revision record](#) information used to track changes in a shared workbook. The **rrd.revid** field MUST be greater than 0. The **rrd.tabid** field MUST NOT be 0xFFFF. The **rrd.rev** field MUST be greater than or equal to 0 and less than or equal to 3.

A - fEndOfList (1 bit): A bit that specifies that a row was inserted at the bottom of the filled cells **range**. This field has meaning only if the **rrd.rev** field of this record is [REVTINSRW](#). MUST be 1 if data was inserted at the bottom of the filled cells range. MUST be 0 if data was inserted or deleted in any other place.

reserved (15 bits): MUST be zero, and MUST be ignored.

refn (8 bytes): A [Ref8U](#) structure that specifies the range of **cells** affected by the insertion or deletion action.

cUcr (4 bytes): An unsigned integer that specifies the number of items in **rgDucr**.

rgDucr (variable): An array of [Ducr](#) structures that specifies undo data to apply to an **expression** for which the **revision** was rejected.

2.4.229 RRDInsDelBegin

The **RRDInsDelBegin** record specifies the beginning of a collection of records as defined by the [Revision Stream ABNF](#). The collection of records specifies a set of [Insertion / Deletion of Rows / Columns Revision](#) changes.

2.4.230 RRDInsDelEnd

The **RRDInsDelEnd** record specifies the end of a collection of records as defined by the [Revision Stream ABNF](#). The collection of records specifies a set of [Insertion / Deletion of Rows / Columns Revision](#) changes.

2.4.231 RRDMove

The **RRDMove** record represents [revision record](#) information about the **range of cells** that have moved.

0	1	2	3	4	5	6	7	8	9	10	11	12	13	14	15	16	17	18	19	20	21	22	23	24	25	26	27	28	29	30	31
rrd (14 bytes)																															
...																															
...																															
...																refSrc															
...																															
...																refDst															

...	
...	tabidSrc
cUcr	
rgDucr (variable)	
...	

rrd (14 bytes): An [RRD](#) structure that specifies the revision record information used to track changes in a [shared workbook](#). The **rrd.revid** MUST be greater than 0. The **rrd.rev** MUST be equal to 0x0004. The **rrd.tabid** MUST NOT be 0xFFFF because this **revision** corresponds to a specific **sheet**.

refSrc (8 bytes): A [Ref8U](#) structure that specifies the original location of the range of cells that moved.

refDst (8 bytes): A [Ref8U](#) structure that specifies the new location of the range of cells that moved.

tabidSrc (2 bytes): A [TabId](#) structure that specifies the sheet on which **refSrc** resides.

cUcr (4 bytes): An unsigned integer that specifies the number of elements in **rgDucr**.

rgDucr (variable): An array of [Ducr](#) structures that specifies undo data that will have to be applied to an **expression** if the revision is rejected.

2.4.232 RRDMoveBegin

The **RRDMoveBegin** record specifies the beginning of a collection of records as defined by the [Revision Stream ABNF](#). The collection of records specifies moved **cells**.

2.4.233 RRDMoveEnd

The **RRDMoveEnd** record specifies the end of a collection of records as defined by the [Revision Stream ABNF](#). The collection of records specifies moved **cells**.

2.4.234 RRDRenSheet

The **RRDRenSheet** record specifies the old and new name of a **sheet** after renaming the sheet in a [shared workbook](#).

0	1	2	3	4	5	6	7	8	9	10	1	2	3	4	5	6	7	8	9	20	1	2	3	4	5	6	7	8	9	30	1		
rrd (14 bytes)																																	
...																																	
...																																	
...																					cchOldName												

stOldName (255 bytes)	
...	
...	
...	cchNewName
...	stNewName (255 bytes)
...	
...	
...	

rrd (14 bytes): An [RRD](#) structure that specifies the [revision record](#) information used to track changes in a shared workbook. The **rrd.revid** MUST be greater than 0. The **rrd.revnt** MUST be equal to 0x0009. The **rrd.tabid** MUST NOT be 0xFFFF.

cchOldName (2 bytes): An unsigned integer that specifies the number of characters in **stOldName** that are used to specify the name of the old sheet. Characters in **stOldName** that are to the right of these used characters are ignored. If **stOldName.fHighByte** is 0, the value MUST be less than or equal to 227. If **stOldName.fHighByte** is 1, the value MUST be less than or equal to 127.

stOldName (255 bytes): An [XLUnicodeStringNoCch](#) structure that specifies the name of the old sheet.

cchNewName (2 bytes): An unsigned integer that specifies the number of characters in **stNewName** that are used to specify the name of the new sheet. Characters in **stNewName** that are to the right of these used characters are ignored. If **stNewName.fHighByte** is 0, the value MUST be less than or equal to 227. If **stNewName.fHighByte** is 1, the value MUST be less than or equal to 127.

stNewName (255 bytes): An [XLUnicodeStringNoCch](#) structure that specifies the name of the new sheet.

2.4.235 RRDRstEtxp

The **RRDRstEtxp** record specifies **font** information for a **formatting run**. Instances of this record MUST be preceded by an [RRDChgCell](#) record that specifies the **cell** containing the formatting run.

0	1	2	3	4	5	6	7	8	9	10	11	12	13	14	15	16	17	18	19	20	21	22	23	24	25	26	27	28	29	30	31
iFmt											cchFontName											fFullStr									
stFontName (62 bytes)																															
...																															
...																															

...	stxp (16 bytes)
...	
...	
...	icvFore
reserved1	reserved2
...	

iFnt (2 bytes): An unsigned integer that specifies the zero-based index of this record in the set of RRDRstEtxp records that have a common preceding RRDCfgCell record. MUST be greater than or equal to zero and less than the **cetxpRst** field of the preceding RRDCfgCell record.

cchFontName (1 byte): An unsigned integer that specifies the count of double-byte **Unicode** characters in **stFontName**. MUST be less than or equal to 0x1F.

fFullStr (1 byte): A Boolean (section 2.5.14) that specifies that **stFontName** contains double-byte Unicode characters. MUST be 0x01 if **cchFontName** is greater than 0. If **cchFontName** is 0, the value of **fFullStr** is undefined and MUST be ignored.

stFontName (62 bytes): A fixed length array of Unicode characters that specifies the name of the font. Characters whose position in this array is greater than **cchFontName** are undefined and MUST be ignored.

stxp (16 bytes): An [Stxp](#) structure that specifies the font attributes.

icvFore (2 bytes): An [Icv](#) structure that specifies the **color palette** value for the font.

reserved1 (2 bytes): MUST be zero, and MUST be ignored.

reserved2 (4 bytes): MUST be zero, and MUST be ignored.

2.4.236 RRDTQSIF

The **RRDTQSIF** record specifies the **query table** field that has been removed in a [shared workbook](#).

0	1	2	3	4	5	6	7	8	9	10	11	12	13	14	15	16	17	18	19	20	21	22	23	24	25	26	27	28	29	30	31
rt																grbitfrt															
ref (variable)																															
...																															
rrd (14 bytes)																															
...																															
...																															

...	idField
...	

rt (2 bytes): An unsigned integer that specifies the RRDTQSIF record type. The value MUST be 0x0808.

grbitfrt (2 bytes): MUST be 0x0001, and MUST be ignored.

ref (variable): An [Ref8U](#) or [Ref8U2007](#) that specifies the **range** of the query table from which the field was removed. If the value of the **wXLVer** field of the [RRDInfo](#) record in this [revision log](#) as specified by the [Revision Stream \(Revision Log\) ABNF](#) is equal to 12, Ref8U2007 is used. Otherwise, Ref8U is used.

rrd (14 bytes): An [RRD](#) that specifies the properties of this **revision record**. The value of **rrd.revid** MUST be 0x0. The value of **rrd.rev** MUST be 0x2E. The value of **rrd.fDelAtEdgeofSort** MUST be 0x0.

idField (4 bytes): An unsigned integer that specifies the identity of this field in the query table. The value MUST be unique among **idField** fields of all RRDTQSIF records in the query table and all [Qsif](#) records in the query table. MUST be greater than 0x00000000 and less than 0x0000FFFF.

2.4.237 RRDUserView

The **RRDUserView** record specifies the changes caused by a **custom view revision** in a [shared workbook](#).

0	1	2	3	4	5	6	7	8	9	10	11	12	13	14	15	16	17	18	19	20	21	22	23	24	25	26	27	28	29	30	31
rrd (14 bytes)																															
...																															
...																															
...																guid (16 bytes)															
...																															
...																															
...																															

rrd (14 bytes): An [RRD](#) that specifies the [revision record](#) information used to track changes in a shared workbook. The **rrd.revid** MUST be 0 because this is a revision that cannot be reviewed. The **rrd.rev** MUST be equal to 0x002B or 0x002C. The **rrd.tabid** MUST be 0xFFFF because this revision does not correspond to a specific **sheet**.

guid (16 bytes): A **GUID** as specified by [\[MS-DTYP\]](#) that specifies the custom view in the **workbook** whose revision caused the changes specified in this record. MUST be globally unique. The value of this field MUST be equal to one of the **guid** fields of the [UserSViewBegin](#) collection in the sheet.

2.4.238 RRFormat

The **RRFormat** record specifies a formatting change that was applied to a **shared workbook**. If the change information is too large for a single RRFormat record, it is split into multiple RRFormat records. This record cannot be continued with [Continue](#) records.

0	1	2	3	4	5	6	7	8	9	10	11	12	13	14	15	16	17	18	19	20	21	22	23	24	25	26	27	28	29	30	31			
rrd (14 bytes)																																		
...																																		
...																																		
...																A	B	C	reserved															
sqref (variable)																																		
...																																		
dxfn (variable)																																		
...																																		

rrd (14 bytes): An [RRD](#) that specifies the [revision record](#) information used to track changes in a [shared workbook](#). The RRD structure MUST conform to the restrictions specified in the following table:

Value	Restriction
rrd.revt	MUST be 0x000B.
rrd.revid	MUST be 0x0.
rrd.tabid	MUST NOT be 0xFFFF.

A - fXfDxf (1 bit): A bit that specifies that the affected **cells** need to have their format reset to the format specified by the current **style** before applying any format from **dxfn**, if present.

B - fXfDxfNull (1 bit): A bit that specifies whether **dxfn** exists.

C - fStyXfDxf (1 bit): A bit that specifies that the format of the cells need to be cleared before applying any format from **dxfn**, if present.

reserved (13 bits): MUST be zero, and MUST be ignored.

sqref (variable): An [SqRefU](#) structure that specifies the location or locations on the **sheet** affected by the formatting changes specified by this record.

dxfn (variable): A [DXFN](#) structure that specifies the new cell formatting. MUST exist if and only if fXfDxfNull is 0.

2.4.239 RRInsertSh

The **RRInsertSh** record specifies the changes caused by inserting a **sheet** in a [shared workbook](#).

0	1	2	3	4	5	6	7	8	9	10	11	12	13	14	15	16	17	18	19	20	21	22	23	24	25	26	27	28	29	30	31
rrd (14 bytes)																															
...																															
...																															
...																itabPos															
reserved																cch															
stName (256 bytes)																															
...																															
...																															

rrd (14 bytes): An [RRD](#) structure that specifies the [revision record](#) information used to track changes in a shared workbook. The **rrd.revid** MUST be greater than 0 because this is a reviewable **revision**. The **rrd.rev** MUST be equal to 0x0005. The **rrd.tabid** MUST NOT be 0xFFFF because this revision corresponds to a specific sheet.

itabPos (2 bytes): A [TabIndex](#) structure that specifies the position of the new sheet in the **workbook**.

reserved (2 bytes): MUST be zero, and MUST be ignored.

cch (2 bytes): An unsigned integer that specifies the number of characters in **stName** that are used to specify the name of the new sheet. Characters in **stName** that are to the right of these used characters are ignored. If **stName.fHighByte** is 0, the value MUST be less than or equal to 227. If **stName.fHighByte** is 1, the value MUST be less than or equal to 127.

stName (256 bytes): An [XLUnicodeStringNoCch](#) structure that specifies the name of the new sheet.

2.4.240 RRSort

The **RRSort** record specifies the changes caused by **sort** actions in a [shared workbook](#).

0	1	2	3	4	5	6	7	8	9	10	11	12	13	14	15	16	17	18	19	20	21	22	23	24	25	26	27	28	29	30	31
rrd (14 bytes)																															
...																															
...																															
...																ref8															
...																															

...	A	reserved
cbSort		
rgSortMap (variable)		
...		

rrd (14 bytes): An [RRD](#) structure that specifies the [revision record](#) information used to track changes in a shared workbook. The **rrd.rev** MUST be equal to 0x0007. The **rrd.tabid** MUST NOT be 0xFFFF because this **revision** corresponds to a specific **sheet**.

ref8 (8 bytes): A [Ref8U](#) structure that specifies the **range** of cells affected by sort actions. If the value of **fCol** is 0, the range of rows MUST be within the valid range of the number of rows on the sheet as defined in the used range specified by the [Dimensions](#) record. If the value of **fCol** is 1, the range of columns MUST be within the valid range of the number of columns on the sheet as defined in the used range specified by the [Dimensions](#) record.

A - fCol (1 bit): A bit that specifies whether sorting is performed on the columns.

Value	Meaning
0	The rows have been reordered.
1	The columns have been reordered.

reserved (15 bits): MUST be zero, and MUST be ignored.

cbSort (4 bytes): An unsigned integer that specifies the size of **rgSortMap** in bytes.

rgSortMap (variable): An array of [SortItem](#) structures. The size MUST be equal to **cbSort**.

2.4.241 RRTabId

The **RRTabId** record specifies an array of unique **sheet** identifiers, each of which is associated with a sheet in the **workbook**. The order of the sheet identifiers in the array matches the order of the [BoundSheet8](#) records as they appear in the [Globals Substream](#). If the workbook contains more than 4112 sheets, then this record is not present and each sheet identifier is specified by the order in which the [BoundSheet8](#) records appear in the [Globals Substream](#), beginning with 1. [<115>](#)

0	1	2	3	4	5	6	7	8	9	10	11	12	13	14	15	16	17	18	19	20	21	22	23	24	25	26	27	28	29	30	31
rgtabid (variable)																															
...																															

rgtabid (variable): An array of 2-byte unsigned integers. Each element of this array is a unique sheet identifier, which is associated with a sheet in the workbook. The order of the sheet identifiers in the array matches the order in which the [BoundSheet8](#) records appear in the [Globals Substream](#).

2.4.242 SBaseRef

The **SBaseRef** record specifies the location of a [PivotTable view](#) referenced by a [chart](#).

0	1	2	3	4	5	6	7	8	9	10	11	12	13	14	15	16	17	18	19	20	21	22	23	24	25	26	27	28	29	30	31
ref																															
...																															

ref (8 bytes): A [Ref8U](#) structure that specifies the location of a PivotTable view referenced by a chart.

2.4.243 Scatter

The **Scatter** record specifies that the [chart_group](#) is a scatter chart group or a bubble chart group, and specifies the chart group attributes.

0	1	2	3	4	5	6	7	8	9	10	11	12	13	14	15	16	17	18	19	20	21	22	23	24	25	26	27	28	29	30	31
pcBubbleSizeRatio																wBubbleSize															
A	B	C	reserved																												

pcBubbleSizeRatio (2 bytes): An unsigned integer that specifies the size of the [data points](#) as a percentage of their default size. A value of 100 shows all the data points in their default size, as determined by the application. MUST be greater than or equal to 0 and less than or equal to 300. MUST be ignored if the **fBubbles** field is 0.

wBubbleSize (2 bytes): An unsigned integer that specifies how the default size of the data points represents the value. MUST be ignored if the **fBubbles** field is 0. MUST be a value from the following table:

Value	Meaning
0x0001	The area of the data point represents the value.
0x0002	The width of the data point represents the value.

A - fBubbles (1 bit): A bit that specifies whether this chart group is a scatter chart group or bubble chart group. MUST be a value from the following table:

Value	Meaning
0	Scatter chart group
1	Bubble chart group

B - fShowNegBubbles (1 bit): A bit that specifies whether data points with negative values in the chart group are shown on the [chart](#). MUST be ignored if the **fBubbles** field is 0.

C - fHasShadow (1 bit): A bit that specifies whether one or more **data markers** in a scatter chart group or data points in a bubble chart group have shadows.

reserved (13 bits): MUST be zero, and MUST be ignored.

2.4.244 SCENARIO

The **SCENARIO** record specifies a **scenario**.

0	1	2	3	4	5	6	7	8	9	10	11	12	13	14	15	16	17	18	19	20	21	22	23	24	25	26	27	28	29	30	31																																																																																			
cchName											cchComment											fLocked										fHidden																																																																																		
...											rgchNameUser (variable)											...										rgchComment (variable)										...										rgSLC (variable)											...										rgst (variable)											...										unused (variable)											...									

cchName (2 bytes): An unsigned integer that specifies the number of **cells** in the scenario. MUST be greater than zero and less than or equal to 32.

fLocked (1 byte): A Boolean (section 2.5.14) that specifies whether the scenario can be modified if the **workbook** is **protected**. It MUST be a value from the following table:

Value	Meaning
0x00	The user can change the scenario.
0x01	When the workbook is protected, the user cannot change the scenario.

fHidden (1 byte): A Boolean that specifies whether the scenario is to be **hidden** from the user if the workbook is protected. It MUST be a value from the following table:

Value	Meaning
0x00	The scenario is never hidden
0x01	When the workbook is protected, the scenario is hidden from the user.

cchName (1 byte): An unsigned integer that specifies the character count in the field **rgchName**.

cchComment (1 byte): An unsigned integer that specifies the character count in the field **rgchComment**.

cchNameUser (1 byte): An unsigned integer that specifies the character count in the field **rgchNameUser**.

rgchName (variable): An [XLUnicodeStringNoCch](#) structure that specifies the name of the scenario.

rgchNameUser (variable): An [XLUnicodeString](#) structure that specifies the name of the user who created the scenario. The character count MUST be less than or equal to 52. MUST be omitted if **cchNameUser** is 0.

rgchComment (variable): An [XLUnicodeString](#) structure that specifies a **comment** associated with the scenario. MUST be omitted if **cchComment** is 0.

rgSLC (variable): An array of [SLCO8](#) structures. Each element of the array specifies one cell that is changed by the scenario. Its element count MUST be **cref**.

rgst (variable): An array of [XLUnicodeString](#) structures. Each element of the array specifies the value associated to a cell by the scenario. Its element count MUST be **cref**.

unused (variable): Undefined and MUST be ignored. The size of this field in bytes MUST be 2***cref**.

2.4.245 ScenarioProtect

The **ScenarioProtect** record specifies the **protection** state for **scenarios** in a **sheet**. Scenarios are defined in the [Worksheet Substream](#) ABNF.

0	1	2	3	4	5	6	7	8	9	10	11	12	13	14	15	16	17	18	19	20	21	22	23	24	25	26	27	28	29	30	31
fScenProtect																															

fScenProtect (2 bytes): A Boolean (section [2.5.14](#)) that specifies whether the scenarios in the sheet are **protected**. MUST be a value from the following table:

Value	Meaning
0x0000	Scenarios are not protected.
0x0001	Scenarios are protected.

2.4.246 ScenMan

The **ScenMan** record specifies the state of the **Scenario Manager** for the **sheet**.

This record also specifies the beginning of a collection of [Scenario](#) records as defined by the [Worksheet Substream](#) **ABNF**. The collection of Scenario records specifies individual scenarios.

0	1	2	3	4	5	6	7	8	9	10	11	12	13	14	15	16	17	18	19	20	21	22	23	24	25	26	27	28	29	30	31
csct																	isctCur														

isctShown	irefResult
rgref (variable)	
...	

csct (2 bytes): A signed integer that specifies the total number of **scenarios** in the sheet. MUST be equal to the number of Scenario records in the Worksheet substream and MUST be greater than or equal to 0.

isctCur (2 bytes): A signed integer that specifies the zero-based index of the Scenario in this Worksheet substream that is currently **selected** in the Scenario Manager. If **csct** is greater than 0, then **isctCur** MUST be greater than or equal to -1 and MUST be less than the number of Scenario records in the Worksheet substream. The value -1 means that no scenario is currently selected.

isctShown (2 bytes): A signed integer that specifies the zero-based index of the Scenario in this Worksheet substream that specifies the scenario that is currently applied in the sheet associated with this record. If **csct** is greater than 0, then **isctShown** MUST be greater than or equal to -1 and MUST be less than the number of Scenario records in the Worksheet substream. The value -1 means that no scenario is currently shown.

irefResult (2 bytes): A signed integer that specifies the number of **result cells** that are referenced in the field **rgref**. MUST be greater than or equal to 0 and less than or equal to 32.

rgref (variable): An array of [Ref8U](#) structures. Each element specifies a **range** of cells in the current sheet. These cells contain the results that are to be compared across scenarios. Its count MUST be equal to **irefResult**.

2.4.247 Scl

The **Scl** record specifies the **zoom level** of the current view in the window used to display the **sheet** as a fraction given by the following formula:

$$\text{Fraction} = \text{nscl} / \text{dscl}$$

The fraction MUST be greater than or equal to 1/10 and less than or equal to 4.

This record MUST exist if the zoom level of the current view is not equal to 1.

0	1	2	3	4	5	6	7	8	9	1	0	1	2	3	4	5	6	7	8	9	2	0	1	2	3	4	5	6	7	8	9	3	0	1
nscl																		dscl																

nscl (2 bytes): A signed integer that specifies the numerator of the fraction. The value MUST be greater than or equal to 1.

dscl (2 bytes): A signed integer that specifies the denominator of the fraction. The value MUST be greater than or equal to 1.

2.4.248 Selection

The **Selection** record specifies **selected cells** within a **sheet**. There can be multiple contiguous Selection records that have the same **pnn** value to specify all selected cells within a sheet<[116](#)>. If

this is the case, the values of **rwAct**, **colAct**, and **irefAct** MUST be the same across all the contiguous Selection records that have the same **pnn** value.

0	1	2	3	4	5	6	7	8	9	10	11	12	13	14	15	16	17	18	19	20	21	22	23	24	25	26	27	28	29	30	31				
pnn										rwAct										colAct															
...										irefAct										cref															
...										rgref (variable)																									
...																																			

pnn (1 byte): A [PaneType](#) enumeration that specifies the **active pane**.

rwAct (2 bytes): An [RwU](#) structure that specifies the zero-based row number of the **active cell**.

colAct (2 bytes): A [ColU](#) structure that specifies the zero-based column number of the active cell.

irefAct (2 bytes): A signed integer that specifies the zero-based index to the [RefU](#) structure in **rgref** that contains the active cell. MUST be greater than or equal to 0. If this record is one of multiple contiguous Selection records, this value is the index to the RefU structure across the aggregation of **rgref** arrays of all Selection records.

cref (2 bytes): An unsigned integer that specifies the number of RefU structures in the **rgref** array of this record.

rgref (variable): An array of RefU structures that specifies ranges of selected cells in the sheet. The number of RefU structures in this array MUST be less than or equal to 1369.

2.4.249 SerAuxErrBar

The **SerAuxErrBar** record specifies properties of an [error bar](#).

0	1	2	3	4	5	6	7	8	9	10	11	12	13	14	15	16	17	18	19	20	21	22	23	24	25	26	27	28	29	30	31
sertm										ebsrc										fTeeTop						reserved					
numValue																															
...																															
cnum																															

sertm (1 byte): An unsigned integer that specifies the direction of the error bars. MUST be a value from the following table.

Value	Meaning
0x01	Error bars are horizontal in the plus direction.
0x02	Error bars are horizontal in the minus direction.
0x03	Error bars are vertical in the plus direction.
0x04	Error bars are vertical in the minus direction.

ebsrc (1 byte): An unsigned integer that specifies the error amount type of the error bars. MUST be a value from the following table:

Value	Meaning
0x01	Percentage
0x02	Fixed value
0x03	Standard deviation
0x04	Custom values (array of values or range)
0x05	Standard error

If the **cce** field of the [ChartParsedFormula](#) record contained in the **formula** field of the closest preceding [BRAI](#) record with **id** field equal to 0x0001 is 0x0000, then the error bars value source is an array of values. Each value in this array MUST be stored in a [Number](#) record in the [SERIESDATA](#) part of the Chart Sheet substream as specified in the Chart Sheet Substream **ABNF**. The **cell.col** field of each Number record MUST store the zero-based position index of the closest preceding [Series](#) record, as it is calculated across all Series records in the current [Chart Sheet](#) substream. The **cell.rw** field MUST store the zero-based index of this value in the array.

Otherwise, the value source is a range. The closest preceding BRAI record with the **id** field equal to 0x0001 specifies a link to the [Rgce](#) structure that describes this range.

fTeeTop (1 byte): A Boolean (section [2.5.14](#)) that specifies whether the error bars are T-shaped.

reserved (1 byte): MUST be 0x01 and MUST be ignored.

numValue (8 bytes): An Xnum (section [2.5.342](#)) value that specifies the fixed value, percentage, or number of standard deviations for the error bars. If **ebsrc** is equal to 0x05 or 0x04, MUST be ignored.

cnum (2 bytes): An unsigned integer that specifies the number of value or cell references used for custom error bars when **ebsrc** is equal to 0x04. This value MUST be ignored if **ebsrc** does not equal 0x04.

If the value source is an array of values, this value MUST equal the count of Number records whose **cell.col** field stores the zero-based index of the closest preceding Series record in the collection of Series records in the current chart sheet substream.

If the value source is a range, this value MUST equal the count of cell references of the range as specified in the **rgce** field of the [ChartParsedFormula](#) contained in the **formula** field of the closest preceding BRAI record that has an **id** field equal to 0x0001.

2.4.250 SerAuxTrend

The **SerAuxTrend** record specifies a [trendline](#).

0	1	2	3	4	5	6	7	8	9	10	1	2	3	4	5	6	7	8	9	20	1	2	3	4	5	6	7	8	9	30	1		
regt										ordUser										numIntercept													
...																																	
...																	fEquation							fRSquared									

numForecast
...
numBackcast
...

regt (1 byte): An unsigned integer that specifies the type of trendline. The value MUST be one of the following values:

Value	Meaning
0x00	Polynomial
0x01	Exponential
0x02	Logarithmic
0x03	Power
0x04	Moving average

ordUser (1 byte): An unsigned integer that specifies the polynomial order or moving average period. MUST be greater than or equal to 0x02 and less than or equal to 0x06 if **regt** is equal to 0x00; MUST be greater than or equal to 0x02 and less than or equal to the value of the **cValx** field of the [Series](#) record specified by the preceding [SerParent](#) record minus one if **regt** is equal to 0x04. MUST be ignored for trendlines of all other types.

numIntercept (8 bytes): A [ChartNumNillable](#) structure that specifies where the trendline intersects the value [axis](#) or vertical axis on bubble and scatter [chart groups](#). If no intercept is specified, this [ChartNumNillable](#) structure MUST specify a [NilChartNum](#) structure, and the value of the **type** field in the [NilChartNum](#) structure MUST be 0x0100.

fEquation (1 byte): A Boolean (section [2.5.14](#)) that specifies whether the trendline equation is displayed in the trendline label. MUST be ignored if **regt** is equal to 0x04. MUST be ignored if the [chart sheet](#) substream contains an [attached label](#) with an [ObjectLink](#) record that contains both a **wLinkObj** field equal to 0x0004 and a **wLinkVar1** field equal to the zero-based index into a Series record in the collection of Series records in the current chart sheet substream that represents this trendline, and the attached label contains a [SeriesText](#) record.

fRSquared (1 byte): A Boolean that specifies whether the R-squared value is displayed in the trendline label. MUST be ignored if **regt** is equal to 0x04. MUST be ignored if the chart sheet substream contains an attached label with an [ObjectLink](#) record that contains both a **wLinkObj** field equal to 0x0004 and a **wLinkVar1** field equal to the zero-based index into a Series record in the collection of Series records in the current chart sheet substream that represents this trendline, and the attached label contains a [SeriesText](#) record.

numForecast (8 bytes): An [Xnum](#) (section [2.5.342](#)) that specifies the number of periods to **forecast** forward.

numBackcast (8 bytes): An [Xnum](#) that specifies the number of periods to forecast backward.

2.4.251 SerFmt

The **SerFmt** record specifies properties of the associated [data points](#), **data markers**, or lines of the [series](#). The associated data points, data markers, or lines of the series are specified by the preceding [DataFormat](#) record. If this record is not present in the sequence of records that conforms to the [SS](#)

rule of the Chart Sheet Substream **ABNF**, then the properties of the associated data points, data markers, or lines of the series are specified by the default values of the fields of this record.

0	1	2	3	4	5	6	7	8	9	10	11	12	13	14	15	16	17	18	19	20	21	22	23	24	25	26	27	28	29	30	31
A	B	C	reserved																												

A - fSmoothedLine (1 bit): A bit that specifies whether the lines of the series are displayed with a smooth line effect on a scatter, radar, and line [chart group](#). The default value of this field is 0.

B - f3DBubbles (1 bit): A bit that specifies whether the data points of a bubble chart group are displayed with a 3-D effect. MUST be ignored for all other chart groups. The default value of this field is 0.

C - fArShadow (1 bit): A bit that specifies whether the data markers are displayed with a shadow on bubble, scatter, radar, stock, and line chart groups. The default value of this field is 0.

reserved (13 bits): MUST be zero, and MUST be ignored.

2.4.252 Series

The **Series** record specifies properties of the data for a [series](#), a [trendline](#), or [error bars](#), and specifies the beginning of a collection of records as defined by the [Chart Sheet Substream ABNF](#). The collection of records specifies a series, a trendline, or error bars.

0	1	2	3	4	5	6	7	8	9	10	11	12	13	14	15	16	17	18	19	20	21	22	23	24	25	26	27	28	29	30	31
sdtX																sdtY															
cValx																cValy															
sdtBSize																cValBSize															

sdtX (2 bytes): An unsigned integer that specifies the type of data in **categories (2)**, or horizontal values on bubble and scatter [chart groups](#), in the series. MUST be a value from the following table:

Value	Meaning
0x0001	The series contains categories (2), or horizontal values on bubble and scatter chart groups, with numeric information.
0x0003	The series contains categories (2), or horizontal values on bubble and scatter chart groups, with text information.

sdtY (2 bytes): An unsigned integer that specifies that the values or vertical values on bubble and scatter chart groups, in the series contain numeric information. It MUST be 0x0001 and MUST be ignored.

cValx (2 bytes): An unsigned integer that specifies the count of categories (2), or horizontal values on bubble and scatter chart groups, in the series. The value MUST be less than or equal to 32767.

cValy (2 bytes): An unsigned integer that specifies the count of values, or vertical values on bubble and scatter chart groups, in the series. The value MUST be less than or equal to 32767.

sdtBSize (2 bytes): An unsigned integer that specifies that the **bubble size** values in the series contain numeric information. The value MUST be 0x0001, and MUST be ignored.

cValBSize (2 bytes): An unsigned integer that specifies the count of bubble size values in the series. The value MUST be less than or equal to 32767.

2.4.253 SeriesList

The **SeriesList** record specifies the [series](#) for the [chart](#).

0	1	2	3	4	5	6	7	8	9	10	1	2	3	4	5	6	7	8	9	20	1	2	3	4	5	6	7	8	9	30	1		
cser											rgiser (variable)																						
...																																	

cser (2 bytes): An unsigned integer that specifies the count of series indexes in the **rgiser** field.

rgiser (variable): An array of 2-byte unsigned integers, each of which specifies a one-based index of a [Series](#) record in the collection of Series records in the current [chart sheet](#) substream. Each referenced Series specifies a series for the chart.

2.4.254 SeriesText

The **SeriesText** record specifies the text for a [series](#), [trendline](#) name, trendline label, [axis](#) title or [chart](#) title.

0	1	2	3	4	5	6	7	8	9	10	1	2	3	4	5	6	7	8	9	20	1	2	3	4	5	6	7	8	9	30	1		
reserved											stText (variable)																						
...																																	

reserved (2 bytes): MUST be zero, and MUST be ignored.

stText (variable): A [ShortXLUnicodeString](#) that specifies the text string.

2.4.255 SerParent

The **SerParent** record specifies the [series](#) to which the current [trendline](#) or [error bar](#) corresponds.

0	1	2	3	4	5	6	7	8	9	10	1	2	3	4	5	6	7	8	9	20	1	2	3	4	5	6	7	8	9	30	1		
series																																	

series (2 bytes): An unsigned integer that specifies the one-based index of a [Series](#) record in the collection of Series records in the current [chart sheet](#) substream. The referenced Series record specifies the series associated with the current trendline or error bar. The value MUST be greater than or equal to 0x0001 and less than or equal to 0x0FE.

2.4.256 SerToCrt

The **SerToCrt** record specifies the [chart group](#) for the current [series](#).

0	1	2	3	4	5	6	7	8	9	10	11	12	13	14	15	16	17	18	19	20	21	22	23	24	25	26	27	28	29	30	31
id																															

id (2 bytes): An unsigned integer that specifies the zero-based index of a [ChartFormat](#) record in the collection of ChartFormat records in the current [chart sheet](#) substream. The referenced ChartFormat record specifies the chart group that contains the current series.

2.4.257 Setup

The **Setup** record specifies the page format settings used to print the current [sheet](#).

0	1	2	3	4	5	6	7	8	9	10	11	12	13	14	15	16	17	18	19	20	21	22	23	24	25	26	27	28	29	30	31
iPaperSize																iScale															
iPageStart																iFitWidth															
iFitHeight																A	B	C	D	E	F	G	H	I	J	K	L				
iRes																iVRes															
numHdr																															
...																															
numFtr																															
...																															
iCopies																															

iPaperSize (2 bytes): An unsigned integer that specifies the paper size. Refer to the following table for values. The value 0, or values greater than or equal to 256, specify custom printer paper sizes. Values between 118 and 255 are reserved for future use. If **fNoPls** is 1, this value is undefined and MUST be ignored.

Value	Meaning
1	US Letter 8 1/2 x 11 in
2	US Letter Small 8 1/2 x 11 in
3	US Tabloid 11 x 17 in
4	US Ledger 17 x 11 in
5	US Legal 8 1/2 x 14 in
6	US Statement 5 1/2 x 8 1/2 in
7	US Executive 7 1/4 x 10 1/2 in
8	A3 297 x 420 mm

Value	Meaning
9	A4 210 x 297 mm
10	A4 Small 210 x 297 mm
11	A5 148 x 210 mm
12	B4 (JIS) 250 x 354
13	B5 (JIS) 182 x 257 mm
14	Folio 8 1/2 x 13 in
15	Quarto 215 x 275 mm
16	10 x 14 in
17	11 x 17 in
18	US Note 8 1/2 x 11 in
19	US Envelope #9 3 7/8 x 8 7/8
20	US Envelope #10 4 1/8 x 9 1/2
21	US Envelope #11 4 1/2 x 10 3/8
22	US Envelope #12 4 1/2 x 11
23	US Envelope #14 5 x 11 1/2
24	C size sheet
25	D size sheet
26	E size sheet
27	Envelope DL 110 x 220mm
28	Envelope C5 162 x 229 mm
29	Envelope C3 324 x 458 mm
30	Envelope C4 229 x 324 mm
31	Envelope C6 114 x 162 mm
32	Envelope C65 114 x 229 mm
33	Envelope B4 250 x 353 mm
34	Envelope B5 176 x 250 mm
35	Envelope B6 176 x 125 mm
36	Envelope 110 x 230 mm
37	US Envelope Monarch 3.875 x 7.5 in
38	6 3/4 US Envelope 3 5/8 x 6 1/2 in
39	US Std Fanfold 14 7/8 x 11 in
40	German Std Fanfold 8 1/2 x 12 in
41	German Legal Fanfold 8 1/2 x 13 in
42	B4 (ISO) 250 x 353 mm
43	Japanese Postcard 100 x 148 mm
44	9 x 11 in
45	10 x 11 in
46	15 x 11 in
47	Envelope Invite 220 x 220 mm
48	RESERVED--DO NOT USE
49	RESERVED--DO NOT USE
50	US Letter Extra 9 1/2 x 12 in
51	US Legal Extra 9 1/2 x 15 in
52	US Tabloid Extra 11.69 x 18 in
53	A4 Extra 9.27 x 12.69 in
54	Letter Transverse 8 1/2 x 11 in
55	A4 Transverse 210 x 297 mm

Value	Meaning
56	Letter Extra Transverse 9\275 x 12 in
57	SuperA/SuperA/A4 227 x 356 mm
58	SuperB/SuperB/A3 305 x 487 mm
59	US Letter Plus 8.5 x 12.69 in
60	A4 Plus 210 x 330 mm
61	A5 Transverse 148 x 210 mm
62	B5 (JIS) Transverse 182 x 257 mm
63	A3 Extra 322 x 445 mm
64	A5 Extra 174 x 235 mm
65	B5 (ISO) Extra 201 x 276 mm
66	A2 420 x 594 mm
67	A3 Transverse 297 x 420 mm
68	A3 Extra Transverse 322 x 445 mm
69	Japanese Double Postcard 200 x 148 mm
70	A6 105 x 148 mm
71	Japanese Envelope Kaku #2
72	Japanese Envelope Kaku #3
73	Japanese Envelope Chou #3
74	Japanese Envelope Chou #4
75	Letter Rotated 11 x 8 1/2 11 in
76	A3 Rotated 420 x 297 mm
77	A4 Rotated 297 x 210 mm
78	A5 Rotated 210 x 148 mm
79	B4 (JIS) Rotated 364 x 257 mm
80	B5 (JIS) Rotated 257 x 182 mm
81	Japanese Postcard Rotated 148 x 100 mm
82	Double Japanese Postcard Rotated 148 x 200 mm
83	A6 Rotated 148 x 105 mm
84	Japanese Envelope Kaku #2 Rotated
85	Japanese Envelope Kaku #3 Rotated
86	Japanese Envelope Chou #3 Rotated
87	Japanese Envelope Chou #4 Rotated
88	B6 (JIS) 128 x 182 mm
89	B6 (JIS) Rotated 182 x 128 mm
90	12 x 11 in
91	Japanese Envelope You #4
92	Japanese Envelope You #4 Rotated
93	PRC 16K 146 x 215 mm
94	PRC 32K 97 x 151 mm
95	PRC 32K(Big) 97 x 151 mm
96	PRC Envelope #1 102 x 165 mm
97	PRC Envelope #2 102 x 176 mm
98	PRC Envelope #3 125 x 176 mm
99	PRC Envelope #4 110 x 208 mm
100	PRC Envelope #5 110 x 220 mm
101	PRC Envelope #6 120 x 230 mm

Value	Meaning
102	PRC Envelope #7 160 x 230 mm
103	PRC Envelope #8 120 x 309 mm
104	PRC Envelope #9 229 x 324 mm
105	PRC Envelope #10 324 x 458 mm
106	PRC 16K Rotated
107	PRC 32K Rotated
108	PRC 32K(Big) Rotated
109	PRC Envelope #1 Rotated 165 x 102 mm
110	PRC Envelope #2 Rotated 176 x 102 mm
111	PRC Envelope #3 Rotated 176 x 125 mm
112	PRC Envelope #4 Rotated 208 x 110 mm
113	PRC Envelope #5 Rotated 220 x 110 mm
114	PRC Envelope #6 Rotated 230 x 120 mm
115	PRC Envelope #7 Rotated 230 x 160 mm
116	PRC Envelope #8 Rotated 309 x 120 mm
117	PRC Envelope #9 Rotated 324 x 229 mm
118	PRC Envelope #10 Rotated 458 x 324 mm

iScale (2 bytes): An unsigned integer that specifies the scaling factor for printing as a percentage. For example, if the value is 107 then the scaling factor is 107%. If **fNoPls** is 1, this value is undefined and MUST be ignored.

iPageStart (2 bytes): A signed integer that specifies the starting page number. If **fUsePage** is 0, MUST be ignored.

iFitWidth (2 bytes): An unsigned integer that specifies the number of pages the sheet width is fit to. MUST be less than or equal to 32767. The value 0 means use as many pages as necessary to print the columns in the sheet.

iFitHeight (2 bytes): An unsigned integer that specifies the number of pages the sheet height is fit to. MUST be less than or equal to 32767. The value 0 means use as many pages as necessary to print the rows of the sheet.

A - fLeftToRight (1 bit): A bit that specifies the order that multiple pages are sent to the printer for a single sheet.

Value	Meaning
0	Pages are printed top-to-bottom first and then left-to-right.
1	Pages are printed left-to-right first and then top-to-bottom.

B - fPortrait (1 bit): A bit that specifies whether to print using portrait mode or landscape mode. If **fNoPls** is 1, the value is undefined and MUST be ignored. If **fNoOrient** is 1, the value is undefined and MUST be ignored.

Value	Meaning
0	Pages are printed using landscape mode.
1	Pages are printed using portrait mode.

C - fNoPls (1 bit): A bit that specifies whether the **iPaperSize**, **iScale**, **iRes**, **iVRes**, **iCopies**, **fNoOrient**, and **fPortrait** data are undefined and ignored. If the value is 1, they are undefined and ignored.

D - fNoColor (1 bit): A bit that specifies whether the document is printed in black and white.

E - fDraft (1 bit): A bit that specifies whether the document is printed using draft quality.

F - fNotes (1 bit): A bit that specifies whether **comments** are printed.

G - fNoOrient (1 bit): A bit that specifies whether the paper orientation is set.

Value	Meaning
0	Paper orientation is specified by the value of fPortrait .
1	Pages are printed using portrait mode.

H - fUsePage (1 bit): A bit that specifies whether a custom starting page number is used to print. If the value is 1, the custom starting page number specified by the value of **iPageStart** is used.

I - unused1 (1 bit): Undefined and MUST be ignored.

J - fEndNotes (1 bit): A bit that specifies whether the comments are printed at the end of the sheet. If **fNotes** is 0, the value MUST be ignored.

Value	Meaning
0	Comments are printed as displayed on the sheet.
1	Comments are printed at the end of the sheet.

K - iErrors (2 bits): An unsigned integer that specifies how to handle errors in the **cell** data. MUST be a value from the following table:

Value	Meaning
0	Print errors as displayed on the sheet.
1	Print errors as blank.
2	Print errors as dashes ("--").
3	Print errors as "#N/A".

L - reserved (4 bits): MUST be zero, and MUST be ignored.

iRes (2 bytes): An unsigned integer that specifies the print resolution in dots per inch (DPI). If **fNoPls** is 1, this value is undefined and MUST be ignored.

iVRes (2 bytes): An unsigned integer that specifies the vertical print resolution in DPI. If **fNoPls** is 1, this value is undefined and MUST be ignored.

numHdr (8 bytes): An Xnum (section [2.5.342](#)) value that specifies the header margin in inches. The value MUST be greater than or equal to 0 and less than 49.

numFtr (8 bytes): An Xnum value that specifies the footer margin in inches. The value MUST be greater than or equal to 0 and less than 49.

iCopies (2 bytes): An unsigned integer that specifies the number of copies to print. If **fNoPls** is 1, this value is undefined and MUST be ignored.

2.4.258 ShapePropsStream

The **ShapePropsStream** record specifies the **shape** formatting properties for [chart](#) elements. These shape formatting properties are a superset of the properties stored in the [LineFormat](#), [AreaFormat](#), [MarkerFormat](#), and [GelFrame](#) records. They are stored in the **rgb** field, which is an **XML stream** (section [2.1.7.22](#)), as defined in [\[ECMA-376\]](#) Part 4, section 5.7.2.198. <117>

0	1	2	3	4	5	6	7	8	9	10	11	12	13	14	15	16	17	18	19	20	21	22	23	24	25	26	27	28	29	30	31
frtHeader																															
...																															
...																															
wObjContext																unused															
dwChecksum																															
cb																															
rgb (variable)																															
...																															

frtHeader (12 bytes): An [FrtHeader](#) structure. The **frtHeader.rt** field of the field MUST be 0x08A4.

wObjContext (2 bytes): An unsigned integer that specifies the chart element that the shape formatting properties in this record apply to.

If this record is in a sequence of records that specifies an [AXS](#) rule, then it MUST be a value from the following table:

Value	Meaning
0x0000	The shape properties in this record apply to the axis .
0x0001	The shape properties in this record apply to the major gridlines of the axis.
0x0002	The shape properties in this record apply to the minor gridlines of the axis.
0x0003	The shape properties in this record apply to the three-dimensional surfaces of the walls or floor .

If this record precedes an [End](#) record matched by a [Begin](#) record in a sequence of records that conforms to the CRT rule, then this field MUST be a value from the following table:

Value	Meaning
0x0000	The shape properties in this record apply to the drop lines of the chart group .
0x0001	The shape properties in this record apply to the high-low lines of the chart group.
0x0002	The shape properties in this record apply to the leader lines of the chart group.
0x0003	The shape properties in this record apply to the series lines of the chart group.

If this record is in a sequence of records that conforms to the SS rule, then this field MUST be a value from the following table:

Value	Meaning
0x0000	The shape properties in this record apply to the series , data points , error bars , or trendlines specified by the DataFormat record.
0x0001	The shape properties in this record apply to the data markers specified by the DataFormat record.

If this record is in a sequence of records that conforms to the FRAME rule, then it MUST be 0x0000, which means the shape properties apply to the current **chart area** (section [2.2.3.17](#)), **plot area**, [legend](#), or [attached label](#).

If this record is in a sequence of records that conforms to the DROPBAR rule as specified by the Chart Sheet Substream **ABNF**, then it MUST be 0x0000, which means the shape properties apply to **up bar** or **down bar** formatting.

unused (2 bytes): Undefined and MUST be ignored.

dwChecksum (4 bytes): An unsigned integer that specifies the **checksum** of the shape formatting properties related to this record. The algorithm used to calculate the checksum is defined by [\[MS-OSHARED\]](#) section 2.4.3.2. The checksum MUST be calculated by using every property of the **property stream**, as a stream of bytes as specified by the [ShapePropsStreamChecksumData](#) structure.

The information required to build the stream of bytes can be gathered from the LineFormat, AreaFormat, MarkerFormat, and GelFrame records associated with this record, as specified by [LinePropertiesForShapePropsStreamChecksum](#), [InteriorColorPropertiesForShapePropsStreamChecksum](#), and [FillStylePropertiesForShapePropsStreamChecksum](#).

When reading this record, the checksum is calculated as previously specified and compared to the **dwChecksum** value stored in this record. If the calculated checksum does not match the **dwChecksum** value, the application MUST assume that the XML stream is out of date, and the data from the LineFormat, AreaFormat, MarkerFormat, and GelFrame records MUST be used instead of the data specified by the **XML stream** (section 2.1.7.22).

cb (4 bytes): An unsigned integer that specifies the length of the character array in the **rgb** field.

rgb (variable): An array of ANSI characters whose length is specified by **cb** that contains the XML representation of the shape formatting properties as defined in [ECMA-376] Part 4, section 5.7.2.198. [<118>](#)

2.4.259 SheetExt

The **SheetExt** record specifies **sheet** properties, including **sheet tab** color and additional optional information specified by using the [SheetExtOptional](#) structure.

0	1	2	3	4	5	6	7	8	9	10	1	2	3	4	5	6	7	8	9	20	1	2	3	4	5	6	7	8	9	30	1		
frtHeader																																	
...																																	
...																																	
cb																																	

icvPlain	reserved
sheetExtOptional (20 bytes, optional)	
...	
...	

frtHeader (12 bytes): An [FrtHeader](#) structure. The **frtHeader.rt** field MUST be 0x0862.

cb (4 bytes): An unsigned integer that specifies the size of this record in bytes.

icvPlain (7 bits): An unsigned integer that specifies the tab color of this sheet. If the tab has a color assigned to it, the value of this field MUST be greater than or equal to 0x08 and less than or equal to 0x3F, as specified in the color table for the [Icv](#) structure. If the tab has no color assigned to it, the value of this field MUST be 0x7F, and MUST be ignored.

reserved (25 bits): MUST be zero, and MUST be ignored.

sheetExtOptional (20 bytes): A SheetExtOptional structure that specifies optional [<119>](#) fields. Exists if and only if the value of **cb** is 0x00000028.

2.4.260 ShrFmla

The **ShrFmla** record specifies a formula (section [2.2.2](#)) that is shared across multiple **cells**. This record specifies a file size optimization. It is used with the [Formula](#) record to compress the amount of storage required for the formula. This record is preceded by a single Formula record that specifies the first cell in the **range** that uses this shared formula. Other Formula records that use this shared formula follow later in the file, not necessarily in a contiguous sequence. Formula records that use this shared formula have the Formula.**fShrFmla** bit set, and a Formula.**cell** that is within the range specified in the **ref** field of this record.

0	1	2	3	4	5	6	7	8	9	10	1	2	3	4	5	6	7	8	9	20	1	2	3	4	5	6	7	8	9	30	1
ref																															
...																reserved								cUse							
formula (variable)																															
...																															

ref (6 bytes): A [RefU](#) structure that specifies the range of cells that use this shared formula. Cells in this range do not have to use the shared formula.

reserved (8 bits): MUST be zero, and MUST be ignored.

cUse (8 bits): An unsigned integer that specifies the number of cells that use this shared formula.

formula (variable): A [SharedParsedFormula](#) structure that specifies the shared formula.

2.4.261 ShtProps

The **ShtProps** record specifies properties of a [chart](#) as defined by the [Chart Sheet Substream ABNF](#).

0	1	2	3	4	5	6	7	8	9	10	11	12	13	14	15	16	17	18	19	20	21	22	23	24	25	26	27	28	29	30	31
A	B	C	D	E	reserved1											mdBlank						reserved2									

A - fManSerAlloc (1 bit): A bit that specifies whether [series](#) are automatically allocated for the chart.

B - fPlotVisOnly (1 bit): A bit that specifies whether to plot **visible** cells only.

C - fNotSizeWith (1 bit): A bit that specifies whether to size the chart with the window.

D - fManPlotArea (1 bit): If **fAlwaysAutoPlotArea** is 1, then this field MUST be 1. If **fAlwaysAutoPlotArea** is 0, then this field MUST be ignored.

E - fAlwaysAutoPlotArea (1 bit): A bit that specifies whether the default **plot area dimension (2)** is used.

Value	Meaning
0	Use the default plot area dimension (2) regardless of the Pos record information.
1	Use the plot area dimension (2) of the Pos record; and fManPlotArea MUST be 1.

reserved1 (11 bits): MUST be zero, and MUST be ignored.

mdBlank (1 byte): An unsigned integer that specifies how the empty cells are plotted be a value from the following table:

Value	Meaning
0x00	Empty cells are not plotted.
0x01	Empty cells are plotted as zero.
0x02	Empty cells are plotted as interpolated.

reserved2 (1 byte): MUST be zero, and MUST be ignored.

2.4.262 SIIndex

The **SIIndex** record is part of a group of records which specify the data of a [chart](#). This particular record indicates the type of data contained in the [Number](#) records following it.

0	1	2	3	4	5	6	7	8	9	10	11	12	13	14	15	16	17	18	19	20	21	22	23	24	25	26	27	28	29	30	31
numIndex																															

numIndex (2 bytes): An unsigned integer that specifies the type of the data records contained by the Number records following it. MUST be a value from the following table:

Value	Number Records Following It Contain
0x0001	Series values or vertical values (for scatter or bubble chart groups)

Value	Number Records Following It Contain
0x0002	Category labels or horizontal values (for scatter or bubble chart groups)
0x0003	Bubble sizes

2.4.263 Sort

The **Sort** record specifies the information used to **sort** values contained in a **range** of **cells**.

0	1	2	3	4	5	6	7	8	9	10	1	2	3	4	5	6	7	8	9	20	1	2	3	4	5	6	7	8	9	30	1
A	B	C	D	E	iOrder					F	reserved1					cchKey1					cchKey2										
cchKey3					stKey1 (variable)																										
...																															
stKey2 (variable)																															
...																															
stKey3 (variable)																															
...																															
reserved2																															

A - fCol (1 bit): A bit that specifies whether to sort by columns or rows. MUST be one of the values from the following table:

Value	Meaning
0	Sort rows from top to bottom.
1	Sort columns from logical left to right.

B - fKey1Dsc (1 bit): A bit that specifies whether **stKey1** sorts in **descending order**. MUST be one of the values from the following table:

Value	Meaning
0	Sort in ascending order.
1	Sort in descending order.

C - fKey2Dsc (1 bit): A bit that specifies whether **stKey2** sorts in descending order. MUST be one of the values from the following table:

Value	Meaning
0	Sort in ascending order.
1	Sort in descending order.

D - fKey3Dsc (1 bit): A bit that specifies whether **stKey3** sorts in descending order. MUST be one of the values from the following table:

Value	Meaning
0	Sort in ascending order.
1	Sort in descending order.

E - fCaseSensitive (1 bit): A bit that specifies whether the sort is case-sensitive. MUST be one of the values from the following table:

Value	Meaning
0	The sort is not case-sensitive.
1	The sort is case-sensitive.

iOrder (5 bits): A signed integer that specifies the zero-based index of the **custom list** that specifies the **sort order**. The set of custom lists is based on the current user's environment.

For more information about how the set of custom lists is determined see [\[MSFT-XL2000\]](#).

F - fAltMethod (1 bit): A bit that specifies whether to use **phonetic information** when sorting. MUST be one of the values from the following table:

Value	Meaning
0	Do not use phonetic information when sorting.
1	Use phonetic information when sorting.

reserved1 (5 bits): MUST be zero, and MUST be ignored.

cchKey1 (1 byte): An unsigned integer that specifies the length of **stKey1**.

cchKey2 (1 byte): An unsigned integer that specifies the length of **stKey2**.

cchKey3 (1 byte): An unsigned integer that specifies the length of **stKey3**.

stKey1 (variable): An [XLUnicodeStringNoCch](#) structure that specifies the string for the first sort key. MUST exist if and only if **cchKey1** is greater than 0.

stKey2 (variable): An [XLUnicodeStringNoCch](#) structure that specifies the string for the second sort key. MUST exist if and only if **cchKey2** is greater than 0.

stKey3 (variable): An [XLUnicodeStringNoCch](#) structure that specifies the string for the third sort key. MUST exist if and only if **cchKey3** is greater than 0.

reserved2 (1 byte): MUST be zero, and MUST be ignored.

2.4.264 SortData

The **SortData** record specifies data used for sorting a **range**.

0	1	2	3	4	5	6	7	8	9	10	11	12	13	14	15	16	17	18	19	20	21	22	23	24	25	26	27	28	29	30	31
frtHeader																															
...																															
...																															
A	B	C	sfp			unused										rfx (16 bytes)															
...																															
...																															
...																cconditions															
...																idParent															
...																sortCond12Array (variable)															
...																															

frtHeader (12 bytes): An [FrtHeader](#) structure. The **frtHeader.rt** field MUST be 0x0895.

A - fCol (1 bit): A bit that specifies whether to **sort** by columns or rows. MUST be one of the values from the following table:

Value	Meaning
0x0	Sort by rows.
0x1	Sort by columns.

B - fCaseSensitive (1 bit): A bit that specifies whether to use a case-sensitive sorting method. MUST be one of the values from the following table:

Value	Meaning
0x0	The sort is not case-sensitive.
0x1	The sort is case-sensitive.

C - fAltMethod (1 bit): A bit that specifies whether to use a sorting method other than character order, such as **stroke order** or **Mandarin phonetic symbols**. MUST be one of the values from the following table:

Value	Meaning
0x0	The sort uses character order.
0x1	The sort uses a method other than character order.

sfp (3 bits): An unsigned integer that specifies the type of the object that contains the sort field. MUST be a value from the following table:

Value	Meaning
0x0	The sort field is contained in a sheet .
0x1	The sort field is contained in a table .
0x2	The sort field is contained in an AutoFilter .
0x3	The sort field is contained in a query table .

unused (10 bits): Undefined and MUST be ignored.

rfx (16 bytes): An [RFX](#) structure that specifies the range to sort.

cconditions (4 bytes): An unsigned integer that specifies the count of **sort conditions**. This record MUST be followed by one [ContinueFrt12](#) record for each sort condition.

idParent (4 bytes): An unsigned integer that specifies the identifier of the object that contains the sort field, if the **sfp** field is 0x1 or 0x3. If the **sfp** field is equal to 0x1, the value of this field MUST be equal to the **idList** field of the associated [TableFeatureType](#). If the **sfp** field is equal to 0x3, the value of this field MUST be equal to the zero-based index of the associated query table ([Qsi](#)) in the [Qsi](#) records in the current substream. If the **sfp** field is equal to 0x0 or 0x2, this is undefined and MUST be ignored.

sortCond12Array (variable): An array of [SortCond12](#) structures that specifies the sort conditions.

2.4.265 SST

The **SST** record specifies string constants.

Each string constant in this record has one or more references in the **workbook**, with the goal of improving performance in opening and saving the file. The [LabelSst](#) record specifies how to make a reference to a string in this record.

0	1	2	3	4	5	6	7	8	9	10	11	12	13	14	15	16	17	18	19	20	21	22	23	24	25	26	27	28	29	30	31
cstTotal																															
cstUnique																															
rgb (variable)																															
...																															

cstTotal (4 bytes): A signed integer that specifies the total number of references in the workbook to the strings in the shared string table. MUST be greater than or equal to 0.

cstUnique (4 bytes): A signed integer that specifies the number of unique strings in the shared string table. MUST be greater than or equal to 0.

rgb (variable): An array of [XLUnicodeRichExtendedString](#) structures. Records in this array are unique.

2.4.266 StartBlock

The **StartBlock** record specifies the beginning of a collection of records. [Future records](#) contained in this collection specify saved features to allow applications that do not support the feature to preserve the information. This record MUST have a matching [EndBlock](#) record. StartBlock and EndBlock pairs can be nested. Up to 100 levels of blocks can be nested.

Prior to writing a [chart-specific future record](#), which is a [record](#) with a record number greater than or equal to 2048 and less than or equal to 2303, according to [Record Enumeration](#), StartBlock records MUST be written according to the following rules:

- A StartBlock record MUST NOT be written if the record is preceded by a [StartObject](#) record but not preceded by the matching [EndObject](#) record. That is, StartBlock and EndBlock pairs MUST NOT belong to any collection defined by StartObject and EndObject.
- If there does not exist a StartBlock record with **iObjectKind** equal to 0x000D without a matching EndBlock record, then a corresponding StartBlock record with **iObjectKind** equal to 0x000D MUST be written.
- If the chart-specific future record exists in the sequence of records that conforms to the [DAT](#) rule, and there does not exist a StartBlock record with **iObjectKind** equal to 0x0006 without a matching EndBlock record, then a corresponding StartBlock record with **iObjectKind** equal to 0x0006 MUST be written. If a StartBlock record is written because of rule number 2, then this StartBlock record MUST be written immediately after that record.
- If the chart-specific future record is in a [series](#), and there does not exist a StartBlock record with **iObjectKind** equal to 0x000C without a matching EndBlock record, then a corresponding StartBlock record with **iObjectKind** equal to 0x000C and **iObjectInstance1** equal to the number of series prior to this series in the current [Sheet](#) MUST be written. If any StartBlock records are written because of rule number 2 or 3, then this StartBlock record MUST be written immediately after those records.
- If the chart-specific future record exists in the sequence of records that conforms to the SS rule, and there does not exist a StartBlock record with **iObjectKind** equal to 0x000E without a matching EndBlock record, then a corresponding StartBlock record with **iObjectKind** equal to 0x000E, **iObjectContext** equal to the **yi** field of the [DataFormat](#) record in the current SS rule, and **iObjectInstance1** equal to the **xi** field of the DataFormat record in the current SS rule MUST be written. If any StartBlock records are written because of rule number 2, 3, or 4, then this StartBlock record MUST be written immediately after those records.
- If the chart-specific future record is in a series, and is part of a collection defined by a [Begin](#) and [End](#) pair written immediately after a [LegendException](#) record, and there does not exist a StartBlock record with **iObjectKind** equal to 0x000A without a matching EndBlock record, then a corresponding StartBlock record with **iObjectKind** equal to 0x000A and **iObjectInstance1** equal to the **iss** field of the LegendException record in the series MUST be written. If any StartBlock records are written because of rule number 2, 3, 4, or 5, then this StartBlock record MUST be written immediately after those records.
- If the chart-specific future record is in an [axis group](#), and there does not exist a StartBlock record with **iObjectKind** equal to 0x0000 without a matching EndBlock record, then a corresponding StartBlock record with **iObjectKind** equal to 0x0000 and **iObjectInstance1** equal to the **iax** field of the [AxisParent](#) record of the axis group MUST be written. If any StartBlock records are written because of rule number 2, 3, 4, 5, or 6, then this StartBlock record MUST be written immediately after those records.
- If the chart-specific future record is in a [Chart Group](#), and there does not exist a StartBlock record with **iObjectKind** equal to 0x0005 without a matching EndBlock record, then a corresponding StartBlock record with **iObjectKind** equal to 0x0005 and **iObjectInstance1** equal to the **iax** field of the AxisParent record of the axis group MUST be written. If any StartBlock records are written

because of rule number 2, 3, 4, 5, 6, or 7, then this StartBlock record MUST be written immediately after those records.

- If the chart-specific future record is in an [axis](#), and there does not exist a StartBlock record with **iObjectKind** equal to 0x0004 without a matching EndBlock record, then:
- If the chart-specific future record exists in the sequence of records that conforms to the IVAXIS rule, then a corresponding StartBlock record with **iObjectKind** equal to 0x0004 and **iObjectInstance1** equal to 0x0000 MUST be written. If any StartBlock records are written because of rule number 2, 3, 4, 5, 6, 7, or 8, then this StartBlock record MUST be written immediately after those records.
- If the chart-specific future record exists in the sequence of records that conforms to the SERIESAXIS rule, then a corresponding StartBlock record with **iObjectKind** equal to 0x0004 and **iObjectInstance1** equal to 0x0002 MUST be written. If any StartBlock records are written because of rule number 2, 3, 4, 5, 6, 7, or 8, then this StartBlock record MUST be written immediately after those records.
- If the chart-specific future record exists in the sequence of records that conforms to the DVAXIS rule, and **wType** of the [Axis](#) record in the sequence of records that conforms to the DVAXIS rule is equal to 0, then a corresponding StartBlock record with **iObjectKind** equal to 0x0004 and **iObjectInstance1** equal to 0x0001 MUST be written. If any StartBlock records are written because of rule number 2, 3, 4, 5, 6, 7, or 8, then this StartBlock record MUST be written immediately after those records.
- If the chart-specific future record exists in the sequence of records that conforms to the DVAXIS rule, and **wType** of the [Axis](#) record in the sequence of records that conforms to the DVAXIS rule is equal to 1, then a corresponding StartBlock record with **iObjectKind** equal to 0x0004 and **iObjectInstance1** equal to 0x0003 MUST be written. If any StartBlock records are written because of rule number 2, 3, 4, 5, 6, 7, or 8, then this StartBlock record MUST be written immediately after those records.
- If the chart-specific future record exists in the sequence of records that conforms to the DROPBAR rule, and there does not exist a StartBlock record with **iObjectKind** equal to 0x000F without a matching EndBlock record, then a corresponding StartBlock record with **iObjectKind** equal to 0x000F and **iObjectInstance1** equal to one less than the number of [DropBar](#) records written prior to the chart-specific future record in the current Chart Group MUST be written. If any StartBlock records are written because of rule number 2, 3, 4, 5, 6, 7, 8, or 9, then this StartBlock record MUST be written immediately after those records.
- If the chart-specific future record is in a [legend](#) and there does not exist a StartBlock record with **iObjectKind** equal to 0x0009 without a matching EndBlock record, then:
- If the chart-specific future record is in a chart group, then a corresponding StartBlock record with **iObjectKind** equal to 0x0009 and **iObjectContext** equal to 0x0001 MUST be written. If any StartBlock records are written because of rule number 2, 3, 4, 5, 6, 7, 8, 9, or 10, then this StartBlock record MUST be written immediately after those records.
- If the chart-specific future record is not in a chart group, then a corresponding StartBlock record with **iObjectKind** equal to 0x0009 and **iObjectContext** equal to 0x0000 MUST be written. If any StartBlock records are written because of rule number 2, 3, 4, 5, 6, 7, 8, 9, or 10, then this StartBlock record MUST be written immediately after those records.
- If the chart-specific future record is in an [attached label](#), and there does not exist a StartBlock record with **iObjectKind** equal to 0x0002 without a matching EndBlock record, then:
- If the chart-specific future record exists in the sequence of records that conforms to the DFTTEXT rule of a chart group, and the **id** field of the [DefaultText](#) record in the sequence of records that conforms to the DFTTEXT rule is greater than or equal to 0x0002, then a corresponding StartBlock record with **iObjectKind** equal to 0x0002, **iObjectContext** equal to 0x0002, and

iObjectInstance1 equal to 0xFFFF MUST be written. If any StartBlock records are written because of rule number 2, 3, 4, 5, 6, 7, 8, 9, 10, or 11, then this StartBlock record MUST be written immediately after those records. Else,

- If the chart-specific future record exists in the sequence of records that conforms to the DFTTEXT rule of a chart group, then a corresponding StartBlock record with **iObjectKind** equal to 0x0002, **iObjectContext** equal to 0x0002, and **iObjectInstance1** equal to the **id** field of the DefaultText record in the sequence of records that conforms to the DFTTEXT rule MUST be written. If any StartBlock records are written because of rule number 2, 3, 4, 5, 6, 7, 8, 9, 10, or 11, then this StartBlock record MUST be written immediately after those records. Else,
- If the **wLinkVar1** of the [ObjectLink](#) record of the attached label is equal to 0x0003, then a corresponding StartBlock record with **iObjectKind** equal to 0x0002, **iObjectContext** equal to 0x0004 and **iObjectInstance1** equal to 0x0000 MUST be written. If any StartBlock records are written because of rules number 2, 3, 4, 5, 6, 7, 8, 9, 10 or 11, then this StartBlock record MUST be written immediately after those records. Else,
- If the **wLinkVar1** of the ObjectLink record of the attached label is equal to 0x0002, then a corresponding StartBlock record with **iObjectKind** equal to 0x0002, **iObjectContext** equal to 0x0004 and **iObjectInstance1** equal to 0x0001 MUST be written. If any StartBlock records are written because of rules number 2, 3, 4, 5, 6, 7, 8, 9, 10 or 11, then this StartBlock record MUST be written immediately after those records. Else,
- If the **wLinkVar1** of the ObjectLink record of the attached label is equal to 0x0007, then a corresponding StartBlock record with **iObjectKind** equal to 0x0002, **iObjectContext** equal to 0x0004, and **iObjectInstance1** equal to 0x0002 MUST be written. If any StartBlock records are written because of rule number 2, 3, 4, 5, 6, 7, 8, 9, 10, or 11, then this StartBlock record MUST be written immediately after those records. Else,
- If the chart-specific future record is in the first attached label of a chart sheet, then a corresponding StartBlock record with **iObjectKind** equal to 0x0002 and **iObjectContext** equal to 0x0000 MUST be written. If any StartBlock records are written because of rule number 2, 3, 4, 5, 6, 7, 8, 9, 10, or 11, then this StartBlock record MUST be written immediately after those records. Else,
- If the chart-specific future record is not in the first attached label of a chart sheet, then a corresponding StartBlock record with **iObjectKind** equal to 0x0002 and **iObjectContext** equal to 0x0005, **iObjectInstance1** equal to **wLinkVar1** of the ObjectLink record of the attached label and **iObjectInstance2** equal to **wLinkVar2** of the ObjectLink record of the attached label MUST be written. If any StartBlock records are written because of rule number 2, 3, 4, 5, 6, 7, 8, 9, 10, or 11, then this StartBlock record MUST be written immediately after those records.
- If the chart-specific future record exists in the sequence of records that conforms to the FRAME rule, and there does not exist a StartBlock record with **iObjectKind** equal to 0x0007 without a matching EndBlock record, then:
 - If the chart-specific future record is in an attached label or legend, then a corresponding StartBlock record with **iObjectKind** equal to 0x0007, **iObjectContext** equal to 0x0000, and **iObjectInstance1** equal to 0x0000 MUST be written. If any StartBlock records are written because of rules number 2, 3, 4, 5, 6, 7, 8, 9, 10, 11, or 12, then this StartBlock record MUST be written immediately after those records. Else,
 - If the chart-specific future record exists in the sequence of records that conforms to the AXES rule, then a corresponding StartBlock record with **iObjectKind** equal to 0x0007, **iObjectContext** equal to 0x0001, and **iObjectInstance1** equal to 0x0000 MUST be written. If any StartBlock records are written because of rule number 2, 3, 4, 5, 6, 7, 8, 9, 10, 11, or 12, then this StartBlock record MUST be written immediately after those records. Else,
 - If the chart-specific future record is in a Sheet, then a corresponding StartBlock record with **iObjectKind** equal to 0x0007, **iObjectContext** equal to 0x0002, and **iObjectInstance1** equal to

0x0000 MUST be written. If any StartBlock records are written because of rule number 2, 3, 4, 5, 6, 7, 8, 9, 10, 11, or 12, then this StartBlock record MUST be written immediately after those records.

0	1	2	3	4	5	6	7	8	9	10	11	12	13	14	15	16	17	18	19	20	21	22	23	24	25	26	27	28	29	30	31
frtHeaderOld																															
iObjectKind																iObjectContext															
iObjectInstance1																iObjectInstance2															

frtHeaderOld (4 bytes): An [FrtHeaderOld](#) structure. The **frtHeaderOld.rt** field MUST be 0x0852.

iObjectKind (2 bytes): An unsigned integer that specifies the type of object that is encompassed by the block. MUST be a value from the following table:

Value	Object Type
0x0000	Axis group
0x0002	Attached label record
0x0004	Axis
0x0005	Chart group
0x0006	Dat record
0x0007	Frame
0x0009	Legend
0x000A	LegendException record
0x000C	Series
0x000D	Sheet
0x000E	DataFormat record
0x000F	DropBar record

iObjectContext (2 bytes): An unsigned integer that specifies the context of the object. This value further specifies the object specified in **iObjectKind**. MUST be a value from the following table:

iObjectKind	iObjectContext	iObjectInstance1	iObjectInstance2	Description of Future Record Type Contents
0x0000 (Axis group)	0x0000	0x0000	0x0000	Primary axis group of the current chart .
0x0000 (Axis group)	0x0000	0x0001	0x0000	Secondary axis group of the current chart.
0x0002 (AttachedLabel)	0x0000	0x0000	0x0000	Chart title of the current chart.
0x0002 (AttachedLabel)	0x0002	0x0000	0x0000	Default data labels in the chart that are not displayed as a percentage of the sum of all data points , and that do not contain values.

iObjectKind	iObjectCont ext	iObjectInst ance1	iObjectInst ance2	Description of Future Record Type Contents
0x0002 (AttachedLabel)	0x0002	0x0001	0x0000	Default data labels that contain values or percentage values.
0x0002 (AttachedLabel)	0x0002	0xFFFF	0x0000	Default for all text in the chart.
0x0002 (AttachedLabel)	0x0004	0x0000	0x0000	A: The title formatting Text record of the Category axis or horizontal value axis on a scatter or bubble chart group.
0x0002 (AttachedLabel)	0x0004	0x0001	0x0000	B: The title formatting Text record of value axis or vertical value axis on a scatter or bubble chart group. A chart MUST NOT have both A and B .
0x0002 (AttachedLabel)	0x0004	0x0002	0x0000	C: The title formatting Text record of the series axis. A chart MUST NOT have both B and C .
0x0002 (AttachedLabel)	0x0005	Data Point Index	Series Index	Data labels for data points in visible series, identified by the zero-based index of the Series record of the current chart and the zero-based index of the AttachedLabel record of the current series.
0x0002 (AttachedLabel)	0x0005	0xFFFF	Series Index	Default data labels for a given series, identified by the zero-based index of the Series record of the current chart.
0x0004 (Axis)	0x0000	0x0000	0x0000	Category axis or fill effect of the walls of the current chart.
0x0004 (Axis)	0x0000	0x0001	0x0000	Value axis or fill effect of the walls of the current chart.
0x0004 (Axis)	0x0000	0x0002	0x0000	Series axis.
0x0004 (Axis)	0x0000	0x0003	0x0000	Horizontal value axis for scatter chart group.
0x0005 (Chart group)	0x0000	0x0000	0x0000	Chart group of the primary axis group.
0x0005 (Chart group)	0x0000	0x0001	0x0000	Chart group of the secondary axis group.
0x0006 (Dat)	0x0000	0x0000	0x0000	Data table definition.
0x0007 (Frame)	0x0000	0x0000	0x0000	Frame of the current CHARTFORMATS, LD, AXES, and ATTACHEDLABEL in the collection.
0x0007 (Frame)	0x0001	0x0000	0x0000	Frame of the plot area .
0x0007 (Frame)	0x0002	0x0000	0x0000	Frame of the chart area (section 2.2.3.17)
0x0009 (Legend)	0x0000	0x0000	0x0000	Legend of the data table.
0x0009 (Legend)	0x0001	0x0000	0x0000	Legend of the chart.
0x000A (LegendException)	0x0000	0xFFFF	0x0000	Default legend formatting exception information for entries in the current legend.
0x000A (LegendException)	0x0000	Series Index	0x0000	Legend formatting exception information for a series index entry in the current legend, identified by the zero-based index of the Series record of the current chart.
0x000C (Series)	0x0000	Series Index	0x0000	Series of the current chart, identified by the zero-based index of the Series record of the current chart.
0x000D (Chart)	0x0000	0x0000	0x0000	Current chart.

iObjectKind	iObjectContext	iObjectInstance1	iObjectInstance2	Description of Future Record Type Contents
0x000E (DataFormat)	Series Index	0xFFFF	0x0000	Default formatting for all data points of a given series identified by the zero-based index of the Series record of the current chart.
0x000E (DataFormat)	Series Index	DataFormat Index	0x0000	Formatting of a given data point identified by the zero-based index of the Series record of the current chart and the zero-based index of the DataFormat record of the current chart.
0x000F (DropBar)	0x0000	0x0000	0x0000	Up bar of the current chart.
0x000F (DropBar)	0x0000	0x0001	0x0000	Down bar of the current chart.

iObjectInstance1 (2 bytes): An unsigned integer that specifies additional information about the context of the object, together with **iObjectContext**, **iObjectInstance2**, and **iObjectKind**. This field MUST equal one of the values specified in the previous **table** under the **iObjectContext** field.

iObjectInstance2 (2 bytes): An unsigned integer that specifies more information about the object context, together with **iObjectContext**, **iObjectInstance1**, and **iObjectKind**. This field MUST equal one of the values specified in the previous table under the **iObjectContext** field.

2.4.267 StartObject

The **StartObject** record specifies the beginning of a collection of [Future Record Type](#) records as defined by the [Chart Sheet Substream ABNF](#). The collection of records specifies a feature saved as a Future Record Type such that an application that does not support the feature can preserve it. This record MUST have a matching [EndObject](#) record. StartObject and EndObject pairs can be nested. Up to 100 levels of blocks can be nested.

0	1	2	3	4	5	6	7	8	9	10	11	12	13	14	15	16	17	18	19	20	21	22	23	24	25	26	27	28	29	30	31
frtHeaderOld																															
iObjectKind																iObjectContext															
iObjectInstance1																iObjectInstance2															

frtHeaderOld (4 bytes): An [FrtHeaderOld](#) structure. The **frtHeaderOld.rt** field MUST be 0x0854.

iObjectKind (2 bytes): An unsigned integer that specifies the kind of object that is encompassed by the block. MUST be a value from the following table:

Value	Object Type Encompassed By the Block	Description of Future Record Type Contents
0x0010	A sequence of records that conforms to the ATTACHEDLABEL rule is encompassed by the block.	Display units labels of the current axis .
0x0011	A sequence of records that conforms to *(Font [Fbi]) is encompassed by the block, as specified by the FONTLIST rule.	Font cache for a given application version. The block contains fonts for only those records introduced in the specified application version.

Value	Object Type Encompassed By the Block	Description of Future Record Type Contents
0x0012	<p>A DefaultText record followed by a sequence of records that conforms to the ATTACHEDLABEL rule is encompassed by the block when in a sequence of records that conforms to the DFTTEXT rule.</p> <p>A sequence of records that conforms to the ATTACHEDLABEL rule is encompassed by the block when in a sequence of records that conforms to the CHARTFORMATS rule.</p>	An extended data label .

iObjectContext (2 bytes): An unsigned integer that specifies the object context. MUST be 0x0000.

iObjectInstance1 (2 bytes): An unsigned integer that specifies additional information about the context of the object, together with **iObjectContext**, **iObjectInstance2**, and **iObjectKind**. This field MUST equal 0x0000 if **iObjectKind** is equal to 0x0010 or 0x0012. MUST be a value from the following table if **iObjectKind** is equal to 0x0011:

iObjectInstance1	Application Version
0x0008	Specifies the application version. <120>
0x0009	Specifies the application version. <121>
0x000A	Specifies the application version. <122>
0x000B	Specifies the application version. <123>
0x000C	Specifies the application version. <124>
0x000E	Specifies the application version. <125>
0x000F	Specifies the application version. <126>

iObjectInstance2 (2 bytes): An unsigned integer that specifies more information about the object context, together with **iObjectContext**, **iObjectInstance1** and **iObjectKind**. This field MUST equal 0x0000.

2.4.268 String

The **String** record specifies the string value of a formula (section [2.2.2](#)).

0	1	2	3	4	5	6	7	8	9	10	1	2	3	4	5	6	7	8	9	20	1	2	3	4	5	6	7	8	9	30	1	
string (variable)																																
...																																

string (variable): An [XLUnicodeString](#) structure that specifies the string value of a formula (section [2.2.2](#)). The value of **string.cch** MUST be less than or equal to 32767.

2.4.269 Style

The **Style** record specifies a [cell style](#).

0	1	2	3	4	5	6	7	8	9	10	11	12	13	14	15	16	17	18	19	20	21	22	23	24	25	26	27	28	29	30	31
ixfe												A			B	builtInData (optional)															
user (variable)																															
...																															

ixfe (12 bits): An unsigned integer that specifies the zero-based index of the [cell style XF](#) in the collection of [XF](#) records in the [Globals Substream](#). See [XFIndex](#) for more information about the organization of XF records in the file.

A - unused (3 bits): Undefined and MUST be ignored.

B - fBuiltIn (1 bit): A bit that specifies whether the cell style is built-in.

builtInData (2 bytes): An optional [BuiltInStyle](#) structure that specifies the built-in cell style properties. MUST exist if and only if **fBuiltIn** is 1. The value of **builtInData.istyBuiltIn** MUST be less than or equal to 0x09.

user (variable): An optional [XLUnicodeString](#) structure that specifies the name of the user-defined cell style. MUST exist if and only if **fBuiltIn** is 0. The number of characters in this string SHOULD be greater than or equal to 1 and MUST be less than or equal to 255. [<127>](#)

2.4.270 StyleExt

The **StyleExt** record specifies additional information for a [cell style](#).

0	1	2	3	4	5	6	7	8	9	10	11	12	13	14	15	16	17	18	19	20	21	22	23	24	25	26	27	28	29	30	31		
frtHeader																																	
...																																	
...																																	
A	B	C	reserved			iCategory										builtInData																	
stName (variable)																																	
...																																	
xfProps (variable)																																	
...																																	

frtHeader (12 bytes): An [FrtHeader](#) structure. The **frtHeader.rt** field MUST be 0x0892.

A - fBuiltIn (1 bit): A bit that specifies if this is a built-in cell style. If the value is 1, this is a built-in cell style. This value MUST match the **fBuiltIn** field of the preceding [Style](#) record.

B - fHidden (1 bit): A bit that specifies whether the cell style is not displayed in the user interface.

C - fCustom (1 bit): A bit that specifies whether the built-in cell style was modified by the user and thus has a custom definition. If this field is equal to 1, then **fBuiltIn** MUST equal 1.

reserved (5 bits): MUST be zero and MUST be ignored.

iCategory (1 byte): An unsigned integer that specifies which **style category (2)** that this style belongs to. MUST be one of the values from the following table:

Value	Meaning
0x00	Custom style
0x01	Good, bad, neutral style
0x02	Data model style
0x03	Title and heading style
0x04	Themed cell style
0x05	Number format style

builtInData (2 bytes): A [BuiltInStyle](#) structure that specifies the built-in cell style properties. If **fBuiltIn** is 0, this field MUST be 0xFFFF and MUST be ignored. If **fBuiltIn** is 1, this field MUST match the **builtInData** field of the preceding Style record.

stName (variable): An [LPWideString](#) structure that specifies the name of the style to extend. MUST be less than or equal to 255 characters in length. If **fBuiltIn** is 0, the name specified by this field MUST match the name specified by the **user** field of the preceding Style record.

xfProps (variable): An [XFProps](#) structure that specifies the formatting properties.

2.4.271 SupBook

The **SupBook** record specifies a [supporting link](#) and specifies the beginning of a collection of records as defined by the [Globals Substream ABNF](#). The collection of records specifies the contents of an [external workbook](#), [DDE data source](#), or [OLE data source](#).

0	1	2	3	4	5	6	7	8	9	10	11	12	13	14	15	16	17	18	19	20	21	22	23	24	25	26	27	28	29	30	31
ctab																cch															
virtPath (variable)																															
...																															
rgst (variable)																															
...																															

ctab (2 bytes): An undefined field, a reserved field, or an unsigned integer that specifies the number of **sheets** in a referenced external workbook. The type and meaning of this field is dependent on the type of supporting link specified by the **cch** and **virtPath** fields, and is defined in the following table:

Type of supporting link specified by cch and virtPath	Meaning
Self-referencing	Undefined and MUST be ignored.
Same-sheet referencing DDE data source referencing OLE data source referencing	Reserved. MUST be 0x0000.
Add-in referencing	Reserved. MUST be 0x0001.
External workbook referencing	An unsigned integer that specifies the count of sheets in the referenced external workbook.
Unused	An unsigned integer that specifies the count of sheets in the external workbook formerly referenced by this supporting link, if this supporting link was an external workbook referencing type, when used. Otherwise, this value MUST be 0x0000.

cch (2 bytes): An unsigned integer that specifies a type of supporting link or specifies the length of the string in **virtPath**. MUST be a value from the following table:

Value	Meaning
0x0401	This record specifies a self-referencing supporting link.
0x3A01	This record specifies an add-in referencing type of supporting link. The names of all add-in functions implemented by XLL , or COM automation add-ins that are referenced by formulas in this workbook , MUST be specified in the ExternName records that follow this record.
0x0001 to 0x00ff (inclusive)	The type of supporting link specified by this record is specified by virtPath . This value is the count of characters in virtPath .

virtPath (variable): An [XLUnicodeStringNoCch](#) structure that specifies the type of supporting link and, if applicable, the target of that supporting link. This field MUST exist if and only if the value of **cch** is between 0x0001 and 0x00ff (inclusive). The length of the string in this field MUST be equal to **cch**. The contents of this field MUST be a value from the following table:

Value	Meaning
A single character of Unicode value 0x20 (SPACE)	This record specifies an unused supporting link. This supporting link MUST NOT be used by any external reference consumers .
A single character of Unicode value 0x00 (NULL)	This record specifies a same-sheet referencing type of supporting link.
A string that conforms to the OLE-link rule, as specified in VirtualPath	This record specifies a DDE data source referencing or an OLE data source referencing type of supporting link. The value of this field specifies the target of the supporting link.
A string that conforms to the virt-path rule, but does not conform to the ole-link rule, as specified in VirtualPath	This record specifies an external workbook referencing type of supporting link. The value of this field specifies the path and file name of the external workbook.

rgst (variable): An array of [XLUnicodeString](#) structures that specify sheet names in the external workbook. This field **MUST** exist if and only if the supporting link type specified by **cch** and **virtPath** is external workbook referencing or unused. If this field exists, the number of elements in this array **MUST** be equal to **ctab**. The contents and meaning of this array are defined in the following table:

Type of supporting link	rgst value
External workbook referencing	An array of XLUnicodeString structures that specify the sheet names in the external workbook. Each element in this array MUST conform to the restrictions set on the stName field of the BoundSheet8 record.
Unused	An array of XLUnicodeString structures that provide placeholders for any XTI references to sheets in this unused supporting link. Each element in this array MUST be a string that contains a single character of Unicode value 0x20 (SPACE).

2.4.272 Surf

The **Surf** record specifies that the [chart group](#) is a surface chart group and specifies the chart group attributes.

0	1	2	3	4	5	6	7	8	9	10	11	12	13	14	15	16	17	18	19	20	21	22	23	24	25	26	27	28	29	30	31
A	B	reserved																													

A - fFillSurface (1 bit): A bit that specifies whether the surface chart group is wireframe or has a **fill**. MUST be a value from the following table:

Value	Meaning
0	Surface chart group is wireframe.
1	Surface chart group has a fill.

B - f3DPhongShade (1 bit): A bit that specifies whether **3-D Phong shading** is displayed.

reserved (14 bits): MUST be zero, and MUST be ignored.

2.4.273 SXAddl Records

2.4.273.1 Continue_SxaddlSxString

The **Continue_SxaddlSxString** record specifies a continuation of the [SXAddl_SXString](#) in the preceding [SXAddl](#) record. If the string specified by the [SXAddl_SXString](#) is longer than 255 characters, the first 255 characters of the string exist in the [SXAddl_SXString](#) in the preceding [SXAddl](#) record. Subsequent 255 character segments exist in one or more [Continue_SxaddlSxString](#) records that exist after the [SXAddl](#) record.

0	1	2	3	4	5	6	7	8	9	10	11	12	13	14	15	16	17	18	19	20	21	22	23	24	25	26	27	28	29	30	31
hdr																															
...																stContinue (variable)															
...																															

hdr (6 bytes): An [SXAddlHdr](#) structure. The value of the **hdr.sxc** field MUST equal the value of the **hdr.sxc** field of the preceding [SXAddl](#) record and the **hdr.sxd** field MUST equal the value of the **hdr.sxd** field of the preceding [SXAddl](#) record.

stContinue (variable): An [SXAddl_SXString](#) structure that specifies the next segment of the string.

2.4.273.2 SXAddl

The **SXAddl** record specifies additional information for a [PivotTable view](#), [PivotCache](#), or **query table**. The current [class](#) and full type of this record are specified by the **hdr** field which determines the contents of the **data** field. See [Usage of SXAddl records](#) for more information.

0	1	2	3	4	5	6	7	8	9	10	11	12	13	14	15	16	17	18	19	20	21	22	23	24	25	26	27	28	29	30	31
hdr																															
...																data (variable)															
...																															

hdr (6 bytes): An [SXAddlHdr](#) structure that specifies header information for an [SXAddl](#) record.

data (variable): A variable-size field that contains data specific to the full record type of the SXAddl record.

2.4.273.3 SXAddl_SXCAutoSort_SXDEnd

The **SXAddl_SXCAutoSort_SXDEnd** record specifies the end of an [SXCAutoSort class](#).

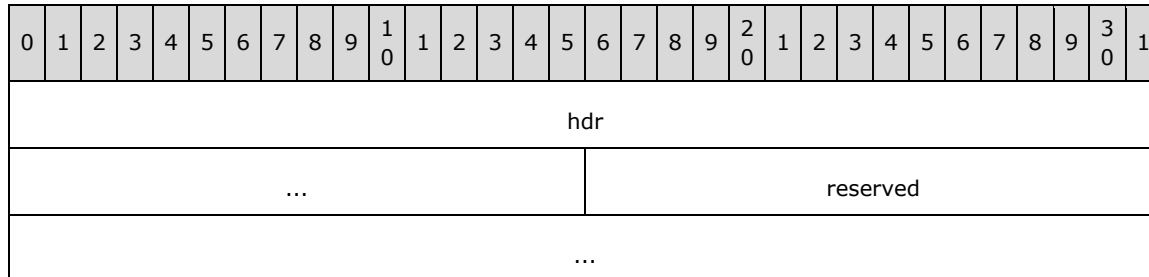

hdr (6 bytes): An [SXAddlHdr](#) structure. The value of **hdr.sxc** MUST equal 0x12 and the value of **hdr.sxd** MUST equal 0xFF.

reserved (6 bytes): MUST be zero, and MUST be ignored.

2.4.273.4 SXAddl_SXCAutoSort_SXDIId

The **SXAddl_SXCAutoSort_SXDIId** record specifies information for [pivot field sorting](#) for an [SXCAutoSort class](#).

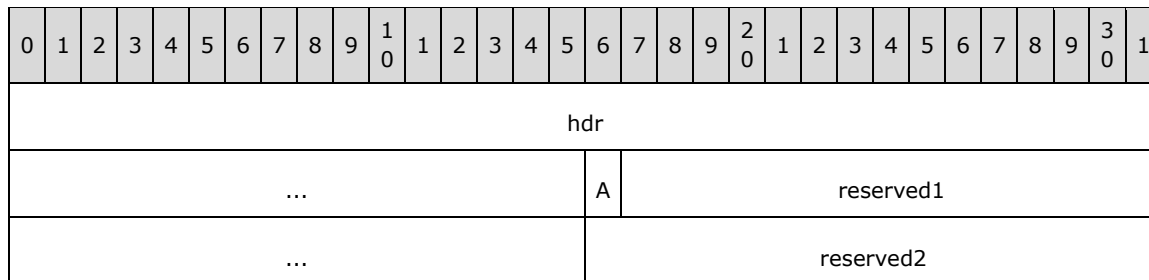

hdr (6 bytes): An [SXAddlHdr](#) structure. The value of **hdr.sxc** MUST equal 0x12 and the value of **hdr.sxd** MUST equal 0x00.

A - fAscendSort (1 bit): A bit that specifies whether the **sort order** is ascending or descending. The value MUST be one of the values from the following table:

Value	Description
0	Sort order is descending.
1	Sort order is ascending.

reserved1 (31 bits): MUST be zero, and MUST be ignored.

reserved2 (2 bytes): MUST be zero, and MUST be ignored.

2.4.273.5 SXAddI_SXCCache_SXDEnd

The **SXAddI_SXCCache_SXDEnd** record specifies the end of an [SxcCache class](#).

0	1	2	3	4	5	6	7	8	9	10	11	12	13	14	15	16	17	18	19	20	21	22	23	24	25	26	27	28	29	30	31
hdr																															
...																reserved															
...																															

hdr (6 bytes): An [SXAddIHdr](#) structure. The value of **hdr.sxc** MUST equal 0x03 and the value of **hdr.sxd** MUST equal 0xFF.

reserved (6 bytes): MUST be zero, and MUST be ignored.

2.4.273.6 SXAddI_SXCCache_SXDId

The **SXAddI_SXCCache_SXDId** record specifies how an [SxcCache class](#) is associated with other records for a [PivotCache](#).

0	1	2	3	4	5	6	7	8	9	10	11	12	13	14	15	16	17	18	19	20	21	22	23	24	25	26	27	28	29	30	31
hdr																															
...																idCache															
...																reserved															

hdr (6 bytes): An [SXAddIHdr](#) structure. The value of **hdr.sxc** MUST equal 0x03 and the value of **hdr.sxd** MUST equal 0x00.

idCache (4 bytes): An unsigned integer that specifies the PivotCache **stream** associated with this SxcCache class. MUST be equal to the **idStm** field of the [SXStreamID](#) record of the PivotCache stream associated with this SxcCache class.

reserved (2 bytes): MUST be zero, and MUST be ignored.

2.4.273.7 SXAddI_SXCCache_SXDInfo12

The **SXAddI_SXCCache_SXDInfo12** record specifies information for a [PivotCache](#) for an [SxcCache class](#).

0	1	2	3	4	5	6	7	8	9	10	11	12	13	14	15	16	17	18	19	20	21	22	23	24	25	26	27	28	29	30	31					
hdr																																				
...																A	B	C	reserved1																	
...																reserved2																				

hdr (6 bytes): An [SXAddlHdr](#) structure. The value of **hdr.sxc** MUST equal 0x03 and the value of **hdr.sxd** MUST equal 0x41.

A - fSheetData (1 bit): MUST be zero, and MUST be ignored.

B - fSrvSupportAttribDrill (1 bit): A bit that specifies whether the **data source** of the PivotCache supports attribute drilldown. MUST be ignored if the data source is not **OLAP**.

C - fSrvSupportSubQuery (1 bit): A bit that specifies whether the data source of the PivotCache supports the MDX SUBSELECT statement. MUST be ignored if the data source is not OLAP.

reserved1 (29 bits): MUST be zero, and MUST be ignored.

reserved2 (2 bytes): MUST be zero, and MUST be ignored.

2.4.273.8 SXAddl_SXCCache_SXDInvRefreshReal

The **SXAddl_SXCCache_SXDInvRefreshReal** record specifies properties related to [PivotCache refresh](#) for an [SxcCache class](#).

0	1	2	3	4	5	6	7	8	9	10	11	12	13	14	15	16	17	18	19	20	21	22	23	24	25	26	27	28	29	30	31	
hdr																																
...																A	B	reserved1														
...																reserved2																

hdr (6 bytes): An [SXAddlHdr](#) structure. The value of **hdr.sxc** MUST equal 0x03 and the value of **hdr.sxd** MUST equal 0x34.

A - fEnableRefresh (1 bit): A bit that specifies whether refresh is enabled for the PivotCache.

B - fInvalid (1 bit): A bit that specifies whether the [cache records](#) are not valid. If the value is 1, the cache records MUST be ignored. See cache record for more information.

reserved1 (30 bits): MUST be zero, and MUST be ignored.

reserved2 (2 bytes): MUST be zero, and MUST be ignored.

2.4.273.9 SXAddl_SXCCache_SXDVer10Info

The **SXAddl_SXCCache_SXDVer10Info** record specifies information for a [PivotCache](#) for an [SxcCache class](#).

0	1	2	3	4	5	6	7	8	9	10	11	12	13	14	15	16	17	18	19	20	21	22	23	24	25	26	27	28	29	30	31
hdr																															
...																reserved1															
...																															
citmGhostMax																															

bVerCacheLastRefresh	bVerCacheRefreshableMin	numDateCopy
...		
...		reserved2

hdr (6 bytes): An [SXAddlHdr](#) structure. The value of **hdr.sxc** MUST equal 0x03 and the value of **hdr.sxd** MUST equal 0x02.

reserved1 (6 bytes): MUST be zero, and MUST be ignored.

citmGhostMax (4 bytes): A signed integer that specifies the number of unused [cache items](#) to allow before discarding unused cache items. MUST [<128>](#) be greater than or equal to -1 and less than or equal to 1048576. If this value is -1, the number of unused cache items retained by the application is optimized to balance memory usage on the system and future usage of cache items.

bVerCacheLastRefresh (1 byte): A [DataFunctionalityLevel](#) type that specifies the [data functionality level](#) that the PivotCache was last refreshed with. MUST be 0xFF or one of the values of the DataFunctionalityLevel type. If this value is equal to 0xFF, the data functionality level is not set.

bVerCacheRefreshableMin (1 byte): A DataFunctionalityLevel type that specifies the lowest data functionality level the application is allowed to **refresh** the PivotCache with. MUST be 0xFF or one of the values of the DataFunctionalityLevel type. If this value is equal to 0xFF, the data functionality level is not set.

numDateCopy (8 bytes): A [DateAsNum](#) structure that specifies the date and time when the PivotCache was last refreshed.

reserved2 (2 bytes): MUST be zero, and MUST be ignored.

2.4.273.10 SXAddl_SXCCache_SXDVerSXMMacro

The **SXAddl_SXCCache_SXDVerSXMMacro** record specifies the [data functionality level](#) of the application that created the [PivotCache](#) for an [SxcCache class](#).

0	1	2	3	4	5	6	7	8	9	10	11	12	13	14	15	16	17	18	19	20	21	22	23	24	25	26	27	28	29	30	31
hdr																															
...																dwVer								reserved1							
reserved2																reserved3															

hdr (6 bytes): An [SXAddlHdr](#) structure. The value of **hdr.sxc** MUST equal 0x03 and the value of **hdr.sxd** MUST equal 0x18.

dwVer (1 byte): A [DataFunctionalityLevel](#) type that specifies the data functionality level that the PivotCache was created with.

reserved1 (1 byte): MUST be zero, and MUST be ignored.

reserved2 (2 bytes): MUST be zero, and MUST be ignored.

reserved3 (2 bytes): MUST be zero, and MUST be ignored.

2.4.273.11 SXAddl_SXCCache_SXDVerUpdInv

The **SXAddl_SXCCache_SXDVerUpdInv** record specifies the record-handling behavior for following records of the [SXCCache class](#).

0	1	2	3	4	5	6	7	8	9	10	11	12	13	14	15	16	17	18	19	20	21	22	23	24	25	26	27	28	29	30	31
data																															
...																															
...																															

data (12 bytes): An [SXAddl_SXDVerUpdInv](#) structure. The value of **data.hdr.sxc** MUST equal 0x03 and the value of **data.hdr.sxd** MUST equal 0x01. The value of **data.dwVersionInvalidates** MUST equal 0x0002 or 0x00FF.

If the value of **data.dwVersionInvalidates** is not 0x00FF and is greater than or equal to the value of the **bVerCacheLastRefresh** field of the [SXAddl_SXCCache_SXDVer10Info](#) record of this SXCCache class, the following records of this SXCCache class (including nested classes or until another SXAddl_SXCCache_SXDVerUpdInv record is encountered) MUST be ignored.

2.4.273.12 SXAddl_SXCCacheField_SXDCaption

The **SXAddl_SXCCacheField_SXDCaption** record specifies the caption of a [cache field](#) for an [SxcCacheField class](#). This record exists only if this is an [OLAP PivotCache](#) and the [PivotCache functionality level](#) is greater than 2.

0	1	2	3	4	5	6	7	8	9	10	11	12	13	14	15	16	17	18	19	20	21	22	23	24	25	26	27	28	29	30	31
hdr																															
...																stCaption (variable)															
...																															

hdr (6 bytes): An [SXAddlHdr](#) structure. The value of **hdr.sxc** MUST equal 0x04 and the value of **hdr.sxd** MUST equal 0x2F.

stCaption (variable): A [SXAddl_SXString](#) structure that specifies the caption of the cache field. The number of characters in the string MUST be less than or equal to 255.

2.4.273.13 SXAddl_SXCCacheField_SXDEnd

The **SXAddl_SXCCacheField_SXDEnd** record specifies the end of an [SxcCacheField class](#).

0	1	2	3	4	5	6	7	8	9	10	11	12	13	14	15	16	17	18	19	20	21	22	23	24	25	26	27	28	29	30	31
hdr																															
...																reserved															

...

hdr (6 bytes): An [SXAddIHdr](#) structure. The value of **hdr.sxc** MUST equal 0x04 and the value of **hdr.sxd** MUST equal 0xFF.

reserved (6 bytes): MUST be zero, and MUST be ignored.

2.4.273.14 SXAddI_SXCCacheField_SXDIId

The **SXAddI_SXCCacheField_SXDIId** record specifies how an [SxcCacheField class](#) is associated with other records for a [cache field](#).

0	1	2	3	4	5	6	7	8	9	10	11	12	13	14	15	16	17	18	19	20	21	22	23	24	25	26	27	28	29	30	31
hdr																															
...																stSourceName (variable)															
...																															

hdr (6 bytes): An [SXAddIHdr](#) structure. The value of **hdr.sxc** MUST equal 0x04 and the value of **hdr.sxd** MUST equal 0x00.

stSourceName (variable): An [SXAddI_SXString](#) structure that specifies the name of the cache field to which this SxcCacheField class applies. The number of characters in the string MUST be less than or equal to 255. The corresponding [SXFDB](#) record is the SXFDB record with its **stFieldName** field equal to the value of this field. If there exists no such SXFDB record, then this SxcCacheField class MUST be ignored.

2.4.273.15 SXAddI_SXCCacheField_SXDIfdbMempropMap

The **SXAddI_SXCCacheField_SXDIfdbMempropMap** record specifies the indexes of the [member properties](#) for the [cache field](#) for an [SxcCacheField class](#). This record exists only if this is an [OLAP PivotCache](#) and the [PivotCache functionality level](#) is greater than 2.

0	1	2	3	4	5	6	7	8	9	10	11	12	13	14	15	16	17	18	19	20	21	22	23	24	25	26	27	28	29	30	31
hdr																															
...																reserved															
...																															
rgMap (variable)																															
...																															

hdr (6 bytes): An [SXAddIHdr](#) structure. The value of **hdr.sxc** MUST equal 0x04 and the value of **hdr.sxd** MUST equal 0x30.

reserved (6 bytes): MUST be zero, and MUST be ignored.

rgMap (variable): An array of 2-byte unsigned integers. The array MUST NOT be empty. Each element in the array specifies a cache field index, as specified by Cache Fields. The referenced cache field is associated with a member property as specified in member properties. The **isxtl** field of the [SXVDTE](#) record of the [pivot field](#) associated with the referenced cache field MUST be equal to 0x00007FFF or equal to **isxtl** of the SXVDTE record of the pivot field associated with this cache field. The **ihdb** field of the [SXAddl_SXCCacheField_SXDProperty](#) record associated with the referenced cache field MUST be equal to the **isxth** field of SXVDTE record of the pivot field associated with this cache field. The size of the array MUST be equal to the **ifdbMemProp** field in the [SXAddl_SXCCacheField_SXDIfdbMpMapCount](#) record in this [SXAddl](#) collection. The value of each element in the array MUST be less than the number of cache fields in this [PivotCache](#) as specified by the **cfbdb** field of the [SXDB](#) record for this PivotCache.

2.4.273.16 SXAddl_SXCCacheField_SXDIfdbMpMapCount

The **SXAddl_SXCCacheField_SXDIfdbMpMapCount** record specifies the number of [member properties](#) for the [cache field](#), for an [SxcCacheField class](#). This record exists only if this is an [OLAP PivotCache](#) and the [PivotCache functionality level](#) is greater than 2.

0	1	2	3	4	5	6	7	8	9	10	11	12	13	14	15	16	17	18	19	20	21	22	23	24	25	26	27	28	29	30	31
hdr																															
...																ifdbMemProp															
...																reserved															

hdr (6 bytes): An [SXAddlHdr](#) structure. The value of **hdr.sxc** MUST equal 0x04 and the value of **hdr.sxd** MUST equal 0x31.

ifdbMemProp (4 bytes): An unsigned integer that specifies the number of elements in the array specified by the **rgMap** field of the [SXAddl_SXCCacheField_SXDIfdbMempropMap](#) record that follows this record. MUST be greater than 0 and less than the number of cache fields in this [PivotCache](#).

reserved (2 bytes): MUST be zero, and MUST be ignored.

2.4.273.17 SXAddl_SXCCacheField_SXDProperty

The **SXAddl_SXCCacheField_SXDProperty** record specifies the hierarchy information of the [cache field](#) for an [SxcCacheField class](#). This record exists only if this is an [OLAP PivotCache](#), the [PivotCache functionality level](#) is greater than 2, and this cache field is associated with a [member property](#).

0	1	2	3	4	5	6	7	8	9	10	11	12	13	14	15	16	17	18	19	20	21	22	23	24	25	26	27	28	29	30	31
hdr																															
...																ihdb															
...																reserved															

hdr (6 bytes): An [SXAddlHdr](#) structure. The value of **hdr.sxc** MUST equal 0x04 and the value of **hdr.sxd** MUST equal 0x05.

ihdb (4 bytes): An unsigned integer that specifies a [pivot hierarchy](#) index. The pivot hierarchy index specifies which pivot hierarchy this cache field is part of.

reserved (2 bytes): MUST be zero, and MUST be ignored.

2.4.273.18 SXAddl_SXCCacheField_SXDPropName

The **SXAddl_SXCCacheField_SXDPropName** record specifies the name of a [member property](#) of the associated [cache field](#) for an [SxcCacheField class](#). This record exists only if this is an [OLAP PivotCache](#), the [PivotCache functionality level](#) is greater than 2, and this cache field is associated with a member property.

0	1	2	3	4	5	6	7	8	9	10	11	12	13	14	15	16	17	18	19	20	21	22	23	24	25	26	27	28	29	30	31
hdr																															
...																stPropName (variable)															
...																															

hdr (6 bytes): An [SXAddlHdr](#) structure. The value of **hdr.sxc** MUST equal 0x04 and the value of **hdr.sxd** MUST equal 0x40.

stPropName (variable): An [SXAddl_SXString](#) structure that specifies the name of the member property associated with this cache field. The length of the string MUST be greater than 0 and less than 32768.

2.4.273.19 SXAddl_SXCCacheField_SXDSxrmitmCount

The **SXAddl_SXCCacheField_SXDSxrmitmCount** record specifies the number of [cache item](#) records in this [cache field](#) for an [SxcCacheField class](#). This record exists only if this is an [OLAP PivotCache](#) and the [PivotCache functionality level](#) is greater than 2.

0	1	2	3	4	5	6	7	8	9	10	11	12	13	14	15	16	17	18	19	20	21	22	23	24	25	26	27	28	29	30	31
hdr																															
...																citm															
...																reserved															

hdr (6 bytes): An [SXAddlHdr](#) structure. The value of **hdr.sxc** MUST equal 0x04 and the value of **hdr.sxd** MUST equal 0x2D.

citm (4 bytes): An unsigned integer that specifies the number of cache item records. The value MUST be greater than or equal to 0 and less than or equal to 1048576. The number of [SXADDLCACHEITEM](#) collections that follows this record MUST match this value.

reserved (2 bytes): MUST be zero, and MUST be ignored.

2.4.273.20 SXAddI_SXCCacheItem_SXDEnd

The **SXAddI_SXCCacheItem_SXDEnd** record specifies the end of a collection of [SxcCacheItem classes](#) for the [SxcCacheField class](#).

0	1	2	3	4	5	6	7	8	9	10	11	12	13	14	15	16	17	18	19	20	21	22	23	24	25	26	27	28	29	30	31
hdr																															
...																reserved															
...																															

hdr (6 bytes): An [SXAddIHdr](#) structure. The value of **hdr.sxc** MUST equal 0x09 and the value of **hdr.sxd** MUST equal 0xFF.

reserved (6 bytes): MUST be zero, and MUST be ignored.

2.4.273.21 SXAddI_SXCCacheItem_SXDId

The **SXAddI_SXCCacheItem_SXDId** record specifies how an [SxcCacheItem class](#) is associated with other records for a [cache item](#). The records of this class exist if and only if this is an [OLAP PivotCache](#), the [PivotCache functionality level](#) is greater than or equal to 3, the **fAllAtoms** field of the [SXFDB](#) record of this [cache field](#) is equal to 1, and the **catm** field of that SXFDB record is greater than 0.

0	1	2	3	4	5	6	7	8	9	10	11	12	13	14	15	16	17	18	19	20	21	22	23	24	25	26	27	28	29	30	31
hdr																															
...																dwItem															
...																reserved															

hdr (6 bytes): An [SXAddIHdr](#) structure. The value of **hdr.sxc** MUST equal 0x09 and the value of **hdr.sxd** MUST equal 0x00.

dwItem (4 bytes): An unsigned integer that specifies the cache item index that this SxcCacheItem class applies to.

reserved (2 bytes): MUST be zero, and MUST be ignored.

2.4.273.22 SXAddI_SXCCacheItem_SXDitmMpMapCount

The **SXAddI_SXCCacheItem_SXDitmMpMapCount** record specifies the number of [member property](#) mappings for this [cache item](#), for an [SxcCacheItem class](#).

0	1	2	3	4	5	6	7	8	9	10	11	12	13	14	15	16	17	18	19	20	21	22	23	24	25	26	27	28	29	30	31
hdr																															
...																cMemProps															

...	reserved
-----	----------

hdr (6 bytes): An [SXAddIHdr](#) structure. The value of **hdr.sxc** MUST equal 0x09 and the value of **hdr.sxd** MUST equal 0x33.

cMemProps (4 bytes): An unsigned integer that specifies the number of member property mappings for this cache item.

reserved (2 bytes): MUST be zero, and MUST be ignored.

2.4.273.23 SXAddI_SXCCacheItem_SXDitmMpropMap

The **SXAddI_SXCCacheItem_SXDitmMpropMap** record specifies the mapping of the [member properties](#) for this [cache item](#), for an [SxcCacheItem class](#).

0	1	2	3	4	5	6	7	8	9	10	11	12	13	14	15	16	17	18	19	20	21	22	23	24	25	26	27	28	29	30	31
hdr																															
...																reserved															
...																															
rgMemProps (variable)																															
...																															

hdr (6 bytes): An [SXAddIHdr](#) structure. The value of **hdr.sxc** MUST equal 0x09 and the value of **hdr.sxd** MUST equal 0x32.

reserved (6 bytes): MUST be zero, and MUST be ignored.

rgMemProps (variable): An array of 4-byte signed integers. Each element of this array specifies a cache item index, as specified by Cache Items, in the [cache field](#) associated with that element. For a given element, the associated cache field is the cache field specified by the element with the same index in the **rgMap** array of the preceding [SXAddI_SXCCacheField_SXDIfdbMempropMap](#) record. Each referenced cache item specifies a member property value.

A value of -1 specifies no cache item. Each element in this array MUST be greater than or equal to -1.

2.4.273.24 SXAddI_SXCCacheItem_SXDSxmitmDisp

The **SXAddI_SXCCacheItem_SXDSxmitmDisp** record specifies the display name of this [cache item](#) for an [SxcCacheItem class](#).

0	1	2	3	4	5	6	7	8	9	10	11	12	13	14	15	16	17	18	19	20	21	22	23	24	25	26	27	28	29	30	31
hdr																															
...																stDisplay (variable)															

...

hdr (6 bytes): An [SXAddlHdr](#) structure. The value of **hdr.sxc** MUST equal 0x09 and the value of **hdr.sxd** MUST equal 0x2E.

stDisplay (variable): An [SXAddl_SXString](#) structure that specifies the display name of this cache item.

2.4.273.25 SXAddl_SXCField_SXDEnd

The **SXAddl_SXCField_SXDEnd** record specifies the end of an [SxcField class](#).

0	1	2	3	4	5	6	7	8	9	10	11	12	13	14	15	16	17	18	19	20	21	22	23	24	25	26	27	28	29	30	31
hdr																															
...															reserved																
...																															

hdr (6 bytes): An [SXAddlHdr](#) structure. The value of **hdr.sxc** MUST equal 0x01 and the value of **hdr.sxd** MUST equal 0xFF.

reserved (6 bytes): MUST be zero, and MUST be ignored.

2.4.273.26 SXAddl_SXCField_SXDId

The **SXAddl_SXCField_SXDId** record specifies how an [SxcField class](#) is associated with other records for a [pivot field](#).

0	1	2	3	4	5	6	7	8	9	10	11	12	13	14	15	16	17	18	19	20	21	22	23	24	25	26	27	28	29	30	31
hdr																															
...															stName (variable)																
...																															

hdr (6 bytes): An [SXAddlHdr](#) structure. The value of **hdr.sxc** MUST equal 0x01 and the value of **hdr.sxd** MUST equal 0x00.

stName (variable): An [SXAddl_SXString](#) structure that specifies the pivot field to which this SxcField class applies. The corresponding [SXFDB](#) record, of the associated [cache field](#) of this pivot field, is the SXFDB record with its **stFieldName** field equal to the value of this field. If there exists no such SXFDB record, then this SxcField class MUST be ignored.

2.4.273.27 SXAddl_SXCField_SXDVer10Info

The **SXAddl_SXCField_SXDVer10Info** record specifies additional properties of the [PivotTable fields](#) for an [SxcField class](#).

0	1	2	3	4	5	6	7	8	9	10	11	12	13	14	15	16	17	18	19	20	21	22	23	24	25	26	27	28	29	30	31
hdr																															
...																				A	reserved1										
...																				reserved2											

hdr (6 bytes): An [SXAddlHdr](#) structure. The value of **hdr.sxc** MUST equal 0x01 and the value of **hdr.sxd** MUST equal 0x02.

A - fHideDD (1 bit): A bit that specifies whether the per pivot field drop-down user interface is **hidden** for the pivot field.

reserved1 (31 bits): MUST be zero, and MUST be ignored.

reserved2 (2 bytes): MUST be zero, and MUST be ignored.

2.4.273.28 SXAddl_SXCField12_SXDAutoshow

The **SXAddl_SXCField12_SXDAutoshow** record specifies the number of items for [simple filters](#) in the [pivot field](#) for an [SXCField12 class](#).

0	1	2	3	4	5	6	7	8	9	10	11	12	13	14	15	16	17	18	19	20	21	22	23	24	25	26	27	28	29	30	31
hdr																															
...																				citmAutoShow											
...																				reserved											

hdr (6 bytes): An [SXAddlHdr](#) structure. The value of **hdr.sxc** MUST equal 0x17 and the value of **hdr.sxd** MUST equal 0x37.

citmAutoShow (4 bytes): An unsigned integer that specifies the number of items for simple filters. The value MUST be greater than or equal to 1 and less than or equal to 0x7FFFFFFF.

reserved (2 bytes): MUST be zero, and MUST be ignored.

2.4.273.29 SXAddl_SXCField12_SXDEnd

The **SXAddl_SXCField12_SXDEnd** record specifies the end of an [SXCField12 class](#).

0	1	2	3	4	5	6	7	8	9	10	11	12	13	14	15	16	17	18	19	20	21	22	23	24	25	26	27	28	29	30	31
hdr																															
...																				reserved											

...

hdr (6 bytes): An [SXAddlHdr](#) structure. The value of **hdr.sxc** MUST equal 0x17 and the value of **hdr.sxd** MUST equal 0xFF.

reserved (6 bytes): MUST be zero, and MUST be ignored.

2.4.273.30 SXAddl_SXCField12_SXDIId

The **SXAddl_SXCField12_SXDIId** record specifies how this [SXCField12 class](#) is associated with other records for a [pivot field](#).

0	1	2	3	4	5	6	7	8	9	10	11	12	13	14	15	16	17	18	19	20	21	22	23	24	25	26	27	28	29	30	31
hdr																															
...																stName (variable)															
...																															

hdr (6 bytes): An [SXAddlHdr](#) structure. The value of **hdr.sxc** MUST equal 0x17 and the value of **hdr.sxd** MUST equal 0x00.

stName (variable): An [SXAddl_SXString](#) structure that specifies the name of the pivot field to which this SXCField12 class applies. The corresponding [SXFDB](#) record, of the associated [cache field](#) of this pivot field, is the SXFDB record with its **stFieldName** field equal to the value of this field. If there exists no such SXFDB record, then this SXCField12 class MUST be ignored.

2.4.273.31 SXAddl_SXCField12_SXDISXTH

The **SXAddl_SXCField12_SXDISXTH** record specifies a particular [Pivot Hierarchy](#) to which this [pivot field](#) is associated for an [SXCField12 class](#).

0	1	2	3	4	5	6	7	8	9	10	11	12	13	14	15	16	17	18	19	20	21	22	23	24	25	26	27	28	29	30	31
hdr																															
...																isxth															
...																reserved															

hdr (6 bytes): An [SXAddlHdr](#) structure. The value of **hdr.sxc** MUST equal 0x17 and the value of **hdr.sxd** MUST equal 0x1C.

isxth (4 bytes): An unsigned integer that specifies a pivot hierarchy index that specifies the pivot hierarchy to which this pivot field is associated. See [Association of Pivot Hierarchies and Pivot Fields and Cache Fields](#) for more information.

reserved (2 bytes): MUST be zero, and MUST be ignored.

2.4.273.32 SXAddl_SXCField12_SXDMemberCaption

The **SXAddl_SXCField12_SXDMemberCaption** record specifies the name of the [member property](#) used as a caption for the [pivot field](#), for an [SXCField12 class](#).

0	1	2	3	4	5	6	7	8	9	10	11	12	13	14	15	16	17	18	19	20	21	22	23	24	25	26	27	28	29	30	31
hdr																															
...															stMemberPropertyCaptionUnique (variable)																
...																															

hdr (6 bytes): An [SXAddlHdr](#) structure. The value of **hdr.sxc** MUST equal 0x17 and the value of **hdr.sxd** MUST equal 0x11.

stMemberPropertyCaptionUnique (variable): An [SXAddl_SXString](#) structure that specifies the unique name of the member property used as a caption for the pivot field. MUST be ignored if the value of **fUseMemPropCaption** in [SXAddl_SXCField12_SXDVer12Info](#) is not equal to 1.

2.4.273.33 SXAddl_SXCField12_SXDVer12Info

The **SXAddl_SXCField12_SXDVer12Info** record specifies additional properties of a [pivot field](#) for an [SXCField12 class](#).

0	1	2	3	4	5	6	7	8	9	10	11	12	13	14	15	16	17	18	19	20	21	22	23	24	25	26	27	28	29	30	31			
hdr																																		
...															A	B	C	D	E	F	reserved2													
...															reserved3																			

hdr (6 bytes): An [SXAddlHdr](#) structure. The value of **hdr.sxc** MUST equal 0x17 and the value of **hdr.sxd** MUST equal 0x19.

A - reserved1 (1 bit): MUST be zero, and MUST be ignored.

B - fHiddenLvl (1 bit): A bit that specifies whether the **OLAP** pivot field is a **hidden** level. The value is ignored if it is not an [OLAP PivotTable view](#).

C - fUseMemPropCaption (1 bit): A bit that specifies whether the [member property](#) is used as a caption for the pivot field. If it is set and there is a [SXAddl_SXCField12_SXDMemberCaption](#) record in this SXCField12 class, then the value from the member property specified by SXAddl_SXCField12_SXDMemberCaption is used as captions for the [pivot items](#) of this pivot field.

D - fCompact (1 bit): A bit that specifies where the next pivot field is displayed in the [PivotTable layout](#).

Value	Meaning
0x0	The pivot field is displayed in the next column on the sheet .
0x1	The pivot field is displayed in the same column on the sheet.

E - fNotAutoSortDft (1 bit): A bit that specifies whether, during the next sort operation that is done on this pivot field, the pivot items are sorted or whether the sort condition is remembered and reapplied on subsequent recalculation of the [PivotTable view](#). A value of 1 specifies that pivot items are to be sorted.

F - fFilterInclusive (1 bit): A bit that specifies whether any [manual filter](#) applied to this pivot field specifies pivot items that are included or excluded. If this pivot field is associated with a [pivot hierarchy](#), this value MUST equal the **fFilterInclusive** field on the [SXTM](#) record that specifies the pivot hierarchy that this pivot field is associated with. MUST be a value from the following table:

Value	Meaning
0x0	Any manual filter applied to this pivot field specifies pivot items that are excluded.
0x1	Any manual filter applied to this pivot field specifies pivot items that are included.

reserved2 (26 bits): MUST be zero, and MUST be ignored.

reserved3 (2 bytes): MUST be zero, and MUST be ignored.

2.4.273.34 SXAddI_SXCField12_SXDVerUpdInv

The **SXAddI_SXCField12_SXDVerUpdInv** record specifies the record handling behavior for following records of the [SXCField12 class](#).

0	1	2	3	4	5	6	7	8	9	10	11	12	13	14	15	16	17	18	19	20	21	22	23	24	25	26	27	28	29	30	31
data																															
...																															
...																															

data (12 bytes): An [SXAddI_SXDVerUpdInv](#) structure. The value of **data.hdr.sxc** MUST equal 0x17 and the value of **data.hdr.sxd** MUST equal 0x01. The value of **data.dwVersionInvalidates** MUST equal 0x0002 or 0x00FF.

If the value of **data.dwVersionInvalidates** is not equal to 0x00FF and is greater than or equal to the value of the **VerSxLastUpdated** field of the [QsiSXTag](#) record of this [PivotTable view](#), the following records of this SXField12 class, including nested classes or until another SXAddI_SXCField12_SXDVerUpdInv record is encountered, MUST be ignored.

2.4.273.35 SXAddI_SXCGroup_SXDEnd

The **SXAddI_SXCGroup_SXDEnd** record specifies the end of an [SxcGroup class](#).

0	1	2	3	4	5	6	7	8	9	10	11	12	13	14	15	16	17	18	19	20	21	22	23	24	25	26	27	28	29	30	31
hdr																															
...																reserved															

...

hdr (6 bytes): An [SXAddIHdr](#) structure. The value of **hdr.sxc** MUST equal 0x08 and the value of **hdr.sxd** MUST equal 0xFF.

reserved (6 bytes): MUST be zero, and MUST be ignored.

2.4.273.36 SXAddl_SXCGroup_SXDGrpInfo

The **SXAddl_SXCGroup_SXDGrpInfo** record specifies information about an [OLAP grouping](#) for an [SxcGroup class](#).

0	1	2	3	4	5	6	7	8	9	10	11	12	13	14	15	16	17	18	19	20	21	22	23	24	25	26	27	28	29	30	31	
hdr																																
...																A	B	C	D	reserved2												
...																reserved3																
stUniqueName (variable)																																
...																																
stCaption (variable)																																
...																																
stParentUniqueName (variable)																																
...																																
iGroupNum																																

hdr (6 bytes): An [SXAddIHdr](#) structure. The value of **hdr.sxc** MUST equal 0x08 and the value of **hdr.sxd** MUST equal 0x07.

A - unused1 (1 bit): Undefined and MUST be ignored.

B - reserved1 (2 bits): MUST be zero, and MUST be ignored.

C - unused2 (1 bit): Undefined and MUST be ignored.

D - fHasNoParent (1 bit): A bit that specifies whether the **stParentUniqueName** field does not exist.

reserved2 (27 bits): MUST be zero, and MUST be ignored.

reserved3 (2 bytes): MUST be zero, and MUST be ignored.

stUniqueName (variable): An [XLUnicodeString](#) structure that specifies the fully qualified unique name of the **OLAP** group. The length of this field MUST be less than or equal to 255 characters.

stCaption (variable): An XLUnicodeString structure that specifies the caption (display name) of the OLAP group. The length of this field **MUST** be less than or equal to 255 characters.

stParentUniqueName (variable): An optional XLUnicodeString structure that specifies an **MDX unique name** of the **OLAP member**, which is the parent of the **members (2)** of this group in the OLAP **cube**. This field exists if and only if the value of **fHasNoParent** is zero. The length of this field **MUST** be less than or equal to 255 characters.

iGroupNum (4 bytes): A signed integer that specifies a unique identifier for this OLAP group within the OLAP grouping level containing it. **MUST** be greater than zero.

2.4.273.37 SXAddI_SXCGroup_SXDId

The **SXAddI_SXCGroup_SXDId** record specifies information about an [OLAP grouping](#) for an [SxcGroup class](#).

0	1	2	3	4	5	6	7	8	9	10	11	12	13	14	15	16	17	18	19	20	21	22	23	24	25	26	27	28	29	30	31
hdr																															
...																stName (variable)															
...																															

hdr (6 bytes): An [SXAddIHdr](#) structure. The value of **hdr.sxc** **MUST** equal 0x08 and the value of **hdr.sxd** **MUST** equal 0x00.

stName (variable): An [SXAddI_SXString](#) structure that specifies the name of the **OLAP** group. **MUST** contain less than or equal to 255 characters.

2.4.273.38 SXAddI_SXCGroup_SXDMember

The **SXAddI_SXCGroup_SXDMember** record specifies an **OLAP member** or the name of a group in the subsequent **OLAP level** that is part of this [OLAP grouping](#) for an [SxcGroup class](#).

0	1	2	3	4	5	6	7	8	9	10	11	12	13	14	15	16	17	18	19	20	21	22	23	24	25	26	27	28	29	30	31			
hdr																																		
...																A	B	C	reserved1															
...																reserved2																		
stUnique (variable)																																		
...																																		

hdr (6 bytes): An [SXAddIHdr](#) structure. The value of **hdr.sxc** **MUST** equal 0x08 and the value of **hdr.sxd** **MUST** equal 0x08.

A - unused1 (1 bit): Undefined and **MUST** be ignored.

B - fGroup (1 bit): A bit that specifies whether this record specifies the name of a group in the subsequent OLAP level.

Value	Meaning
0	This record specifies an OLAP member.
1	This record specifies the name of a group in the subsequent OLAP level.

C - unused2 (1 bit): Undefined and MUST be ignored.

reserved1 (29 bits): MUST be zero, and MUST be ignored.

reserved2 (2 bytes): MUST be zero, and MUST be ignored.

stUnique (variable): An [XLUnicodeString](#) that specifies the **MDX unique name** of an OLAP member or the name of a group in the subsequent OLAP level. If the value of **fGroup** is 0, this is an MDX unique name of an OLAP member. If the value of **fGroup** is 1, this is a group name and it MUST match the **stName** field in one of the [SXAddl_SXCGroup_SXDI](#) records for the subsequent OLAP level. The length of this field MUST be less than or equal to 255 characters.

2.4.273.39 SXAddl_SXCGrpLevel_SXDEnd

The **SXAddl_SXCGrpLevel_SXDEnd** record specifies the end of an [SxcGrpLevel class](#).

0	1	2	3	4	5	6	7	8	9	10	11	12	13	14	15	16	17	18	19	20	21	22	23	24	25	26	27	28	29	30	31
hdr																															
...																reserved															
...																															

hdr (6 bytes): An [SXAddlHdr](#) structure. The value of **hdr.sxc** MUST equal 0x07 and the value of **hdr.sxd** MUST equal 0xFF.

reserved (6 bytes): MUST be zero, and MUST be ignored.

2.4.273.40 SXAddl_SXCGrpLevel_SXDGrpLevelInfo

The **SXAddl_SXCGrpLevel_SXDGrpLevelInfo** record specifies information about an [OLAP group](#) for an [SxcGrpLevel class](#).

0	1	2	3	4	5	6	7	8	9	10	11	12	13	14	15	16	17	18	19	20	21	22	23	24	25	26	27	28	29	30	31			
hdr																																		
...																A	B	C	reserved2															

...	reserved3
stLevelName (variable)	
...	

hdr (6 bytes): An [SXAddlHdr](#) structure. The value of **hdr.sxc** MUST equal 0x08 and the value of **hdr.sxd** MUST equal 0x06.

A - fGroupLevel (1 bit): A bit that specifies whether this is a user-defined group level. MUST be a value from the following table:

Value	Meaning
0	The record specifies a group level that corresponds to the source cube level.
1	The record specifies a user-defined group level.

B - reserved1 (1 bit): MUST be zero, and MUST be ignored.

C - fCustomRollup (1 bit): A bit that specifies whether the OLAP group level has **custom rollup**.

reserved2 (29 bits): MUST be zero, and MUST be ignored.

reserved3 (2 bytes): MUST be zero, and MUST be ignored.

stLevelName (variable): An [XLUnicodeString](#) that specifies the display name of the OLAP group level. The length of this field MUST be less than or equal to 255 characters.

2.4.273.41 SXAddl_SXCGrpLevel_SXDIId

The **SXAddl_SXCGrpLevel_SXDIId** record specifies information about an [OLAP group](#), for an [SxcGrpLevel class](#).

0	1	2	3	4	5	6	7	8	9	10	11	12	13	14	15	16	17	18	19	20	21	22	23	24	25	26	27	28	29	30	31
hdr																															
...																stUnique (variable)															
...																															

hdr (6 bytes): An [SXAddlHdr](#) structure. The value of **hdr.sxc** MUST equal 0x07 and the value of **hdr.sxd** MUST equal 0x00.

stUnique (variable): An [SXAddl_SXString](#) that specifies the unique name of the OLAP group level.

2.4.273.42 SXAddl_SXCHierarchy_SXDDisplayFolder

The **SXAddl_SXCHierarchy_SXDDisplayFolder** record specifies the name for the **display folder** for a [pivot hierarchy](#) for an [SxcHierarchy class](#). This record MUST NOT exist if the [PivotCache functionality level](#) of the associated [PivotCache](#) is less than 3.

0	1	2	3	4	5	6	7	8	9	10	11	12	13	14	15	16	17	18	19	20	21	22	23	24	25	26	27	28	29	30	31
hdr																															
...																stDisplayFolder (variable)															
...																															

hdr (6 bytes): An [SXAddIHdr](#) structure. The value of **hdr.sxc** MUST equal 0x02 and the value of **hdr.sxd** MUST equal 0x25.

stDisplayFolder (variable): An [SXAddl_SXString](#) that specifies the name of the pivot hierarchy display folder.

The length of this field MUST be greater than or equal to zero characters and less than or equal to 65535 characters.

2.4.273.43 SXAddl_SXCHierarchy_SXDEnd

The **SXAddl_SXCHierarchy_SXDEnd** record specifies the end of an [Sxchierarchy class](#).

0	1	2	3	4	5	6	7	8	9	10	11	12	13	14	15	16	17	18	19	20	21	22	23	24	25	26	27	28	29	30	31
hdr																															
...																reserved															
...																															

hdr (6 bytes): An [SXAddIHdr](#) structure. The value of **hdr.sxc** MUST equal 0x02 and the value of **hdr.sxd** MUST equal 0xFF.

reserved (6 bytes): MUST be zero, and MUST be ignored.

2.4.273.44 SXAddl_SXCHierarchy_SXDFilterMember

The **SXAddl_SXCHierarchy_SXDFilterMember** record specifies **OLAP members** used in [OLAP page filtering](#) for a [pivot hierarchy](#) on the [page axis](#) for an [Sxchierarchy class](#). MUST NOT exist if the [PivotCache functionality level](#) of the [associated PivotCache](#) is greater than or equal to 3.

0	1	2	3	4	5	6	7	8	9	10	11	12	13	14	15	16	17	18	19	20	21	22	23	24	25	26	27	28	29	30	31
hdr																															
...																A	B	reserved2													
...																reserved3															
cItems																rgStPageItems (variable)															

...

hdr (6 bytes): An [SXAddIHdr](#) structure. The value of **hdr.sxc** MUST equal 0x02 and the value of **hdr.sxd** MUST equal 0x09.

A - reserved1 (1 bit): MUST be 1 and MUST be ignored.

B - fMultFiltHavePlex (1 bit): A bit that specifies whether multiple OLAP members in this pivot hierarchy are selected in the OLAP page filtering. If the value of this field is 0, **cItems** and **rgStPageItems** MUST be ignored.

reserved2 (30 bits): MUST be zero, and MUST be ignored.

reserved3 (2 bytes): MUST be zero, and MUST be ignored.

cItems (2 bytes): An unsigned integer that specifies the number of elements in **rgStPageItems**. MUST be greater than 0 if **fMultFiltHavePlex** is 1.

rgStPageItems (variable): An array of [XLUnicodeString](#). Each element specifies the **MDX unique name** of an OLAP member selected in the OLAP page filtering. The number of elements in the array is specified by **cItems**. The length of each element MUST be greater than zero characters and less than or equal to 255 characters.

2.4.273.45 SXAddI_SXCHierarchy_SXDFilterMember12

The **SXAddI_SXCHierarchy_SXDFilterMember12** record specifies an [OLAP manual filter](#) for a [pivot hierarchy](#). This record MUST NOT exist if the [PivotCache functionality level](#) of the [associated PivotCache](#) is less than 3.

0	1	2	3	4	5	6	7	8	9	10	11	12	13	14	15	16	17	18	19	20	21	22	23	24	25	26	27	28	29	30	31
hdr																															
...																isxtl															
...																reserved															
cItems																rgStMembers (variable)															
...																															

hdr (6 bytes): An [SXAddIHdr](#) structure. The value of **hdr.sxc** MUST equal 0x02 and the value of **hdr.sxd** MUST equal 0x3F.

isxtl (4 bytes): An unsigned integer that specifies the zero-based ordinal of the **OLAP level** in the pivot hierarchy that the OLAP manual filter applies to. MUST be greater than or equal to 0.

reserved (2 bytes): MUST be zero, and MUST be ignored.

cItems (2 bytes): An unsigned integer that specifies the number of items in **rgStMembers**.

rgStMembers (variable): An array of [XLUnicodeString](#). Each element specifies the **MDX unique name** of an **OLAP member** selected in the OLAP manual filter. The number of elements in the array is specified by **cItems**. The length of each element MUST be greater than zero characters and less than or equal to 255 characters.

2.4.273.46 SXAddl_SXCHierarchy_SXDIconSet

The **SXAddl_SXCHierarchy_SXDIconSet** record specifies the **icon set** for a [pivot hierarchy](#), for an [Sxchierarchy class](#).

0	1	2	3	4	5	6	7	8	9	10	11	12	13	14	15	16	17	18	19	20	21	22	23	24	25	26	27	28	29	30	31
hdr																															
...																dwIconset															
...																reserved															

hdr (6 bytes): An [SXAddlHdr](#) structure. The value of **hdr.sxc** MUST equal 0x02 and the value of **hdr.sxd** MUST equal 0x20.

dwIconset (4 bytes): An unsigned integer that specifies the icon set.

MUST be a value from the following table:

Value	Meaning
0x0000	Default
0x0001	3-arrow ascending
0x0002	3-arrow descending
0x0003	5-arrow ascending
0x0004	5-arrow descending
0x0005	5-arrow gray ascending
0x0006	Traffic lights
0x0007	Traffic lights 2
0x0008	Quarters ascending
0x0009	Quarters descending
0x000A	Signs
0x000B	Symbols

reserved (2 bytes): MUST be zero, and MUST be ignored.

2.4.273.47 SXAddl_SXCHierarchy_SXDId

The **SXAddl_SXCHierarchy_SXDId** record specifies how an [Sxchierarchy class](#) is associated with other records for a [pivot hierarchy](#).

0	1	2	3	4	5	6	7	8	9	10	11	12	13	14	15	16	17	18	19	20	21	22	23	24	25	26	27	28	29	30	31
hdr																															
...																stHierUnq (variable)															

...

hdr (6 bytes): An [SXAddIHdr](#) structure. The value of **hdr.sxc** MUST equal 0x02 and the value of **hdr.sxd** MUST equal 0x00.

stHierUnq (variable): An [SXAddl_SXString](#) that specifies the **MDX unique name** of the corresponding pivot hierarchy to which this Sxchierarchy class applies. The corresponding [SXTH](#), of the pivot hierarchy in the [PivotTable view](#), is the SXTH record with its **stUnique** field equal to the value of this field.

If there exists no such SXTH record, then this Sxchierarchy class MUST be ignored.

The length of this field MUST be greater than zero characters and less than or equal to 255 characters.

2.4.273.48 SXAddl_SXCHierarchy_SXDInfo12

The **SXAddl_SXCHierarchy_SXDInfo12** record specifies additional properties for a [pivot hierarchy](#), for an [Sxchierarchy class](#). This record MUST NOT exist if the [PivotCache functionality level](#) of the associated [PivotCache](#) is less than 3.

0	1	2	3	4	5	6	7	8	9	10	11	12	13	14	15	16	17	18	19	20	1	2	3	4	5	6	7	8	9	30	1							
hdr																																						
...																	A	B	C	D	E	reserved1																
...																	reserved2																					

hdr (6 bytes): An [SXAddIHdr](#) structure. The value of **hdr.sxc** MUST equal 0x02 and the value of **hdr.sxd** MUST equal 0x41.

A - fUnbalancedRealKnown (1 bit): A bit that specifies whether **fUnbalancedReal** is valid. MUST be 0 if the pivot hierarchy is grouped.

B - fUnbalancedReal (1 bit): A bit that specifies whether the pivot hierarchy is balanced or unbalanced. If the value is 1 and **fUnbalancedRealKnown** is 1, the pivot hierarchy is unbalanced. If the value is 0 and **fUnbalancedRealKnown** is 1, the pivot hierarchy is balanced. If **fUnbalancedRealKnown** is 0 the value is undefined.

C - fUnbalancedGroupKnown (1 bit): A bit that specifies whether **fUnbalancedGroup** is valid. MUST be 0 if the pivot hierarchy is not grouped.

D - fUnbalancedGroup (1 bit): A bit that specifies whether the [OLAP group](#) pivot hierarchy is balanced or unbalanced. If the value is 1 and **fUnbalancedGroupKnown** is 1, the pivot hierarchy is unbalanced. If the value is 0 and **fUnbalancedGroupKnown** is 1, the pivot hierarchy is balanced. If **fUnbalancedGroupKnown** is 0 the value is undefined.

E - fHidden (1 bit): A bit that specifies whether the **OLAP hierarchy** corresponding to this pivot hierarchy is **hidden**.

reserved1 (27 bits): MUST be zero, and MUST be ignored.

reserved2 (2 bytes): MUST be zero, and MUST be ignored.

2.4.273.49 SXAddI_SXCHierarchy_SXDKPIGoal

The **SXAddI_SXCHierarchy_SXDKPIGoal** record specifies the **MDX unique name** of the **OLAP KPI goal measure** for a **pivot hierarchy**, for a **Sxchierarchy class**. This record MUST NOT exist if the **PivotCache functionality level** of the associated **PivotCache** is less than 3.

0	1	2	3	4	5	6	7	8	9	10	11	12	13	14	15	16	17	18	19	20	21	22	23	24	25	26	27	28	29	30	31
hdr																															
...																stKPIGoal (variable)															
...																															

hdr (6 bytes): An **SXAddIHdr** structure. The value of **hdr.sxc** MUST equal 0x02 and the value of **hdr.sxd** MUST equal 0x28.

stKPIGoal (variable): An **SXAddI_SXString** structure that specifies the MDX unique name of the KPI goal measure.

The length of this field MUST be greater than or equal to zero characters and less than or equal to 32767 characters.

2.4.273.50 SXAddI_SXCHierarchy_SXDKPIStatus

The **SXAddI_SXCHierarchy_SXDKPIStatus** record specifies the **MDX unique name** of the **OLAP KPI status measure** for a **pivot hierarchy**, for a **Sxchierarchy class**. This record MUST NOT exist if the **PivotCache functionality level** of the associated **PivotCache** is less than 3.

0	1	2	3	4	5	6	7	8	9	10	11	12	13	14	15	16	17	18	19	20	21	22	23	24	25	26	27	28	29	30	31
hdr																															
...																stKPIStatus (variable)															
...																															

hdr (6 bytes): An **SXAddIHdr** structure. The value of **hdr.sxc** MUST equal 0x02 and the value of **hdr.sxd** MUST equal 0x29.

stKPIStatus (variable): An **SXAddI_SXString** structure that specifies the MDX unique name of the KPI status measure.

The length of this field MUST be greater than or equal to zero characters and less than or equal to 32767 characters.

2.4.273.51 SXAddI_SXCHierarchy_SXDKPITime

The **SXAddI_SXCHierarchy_SXDKPITime** record specifies the **MDX unique name** of the **OLAP KPI time measure** for a **pivot hierarchy**, for a **Sxchierarchy class**. This record MUST NOT exist if the **PivotCache functionality level** of the associated **PivotCache** is less than 3.

0	1	2	3	4	5	6	7	8	9	10	11	12	13	14	15	16	17	18	19	20	21	22	23	24	25	26	27	28	29	30	31
hdr																															
...																stKPITime (variable)															
...																															

hdr (6 bytes): An [SXAddlHdr](#) structure. The value of **hdr.sxc** MUST equal 0x02 and the value of **hdr.sxd** MUST equal 0x2C.

stKPITime (variable): An [SXAddl_SXString](#) structure that specifies the MDX unique name of the KPI time **Multidimensional Expressions (MDX)**.

The length of this field MUST be greater than or equal to zero characters and less than or equal to 32767 characters.

2.4.273.52 SXAddl_SXCHierarchy_SXDKPITrend

The **SXAddl_SXCHierarchy_SXDKPITrend** record specifies the **MDX unique name** of the **OLAP KPI** trend **measure** for a [pivot hierarchy](#), for a [SxcHierarchy class](#). This record MUST NOT exist if the [PivotCache functionality level](#) of the associated [PivotCache](#) is less than 3.

0	1	2	3	4	5	6	7	8	9	10	11	12	13	14	15	16	17	18	19	20	21	22	23	24	25	26	27	28	29	30	31
hdr																															
...																stKPItrend (variable)															
...																															

hdr (6 bytes): An [SXAddlHdr](#) structure. The value of **hdr.sxc** MUST equal 0x02 and the value of **hdr.sxd** MUST equal 0x2A.

stKPItrend (variable): An [SXAddl_SXString](#) structure that specifies the MDX unique name of the KPI trend measure.

The length of this field MUST be greater than or equal to zero characters and less than or equal to 32767 characters.

2.4.273.53 SXAddl_SXCHierarchy_SXDKPIValue

The **SXAddl_SXCHierarchy_SXDKPIValue** record specifies the **MDX unique name** of the **OLAP KPI** value **measure** for a [pivot hierarchy](#), for a [SxcHierarchy class](#). This record MUST NOT exist if the [PivotCache functionality level](#) of the associated [PivotCache](#) is less than 3.

0	1	2	3	4	5	6	7	8	9	10	11	12	13	14	15	16	17	18	19	20	21	22	23	24	25	26	27	28	29	30	31
hdr																															
...																stKPIValue (variable)															

...

hdr (6 bytes): An [SXAddIHdr](#) structure. The value of **hdr.sxc** MUST equal 0x02 and the value of **hdr.sxd** MUST equal 0x27.

stKPIValue (variable): An [SXAddI_SXString](#) structure that specifies the MDX unique name of the KPI value measure.

The length of this field MUST be greater than zero characters and less than or equal to 32767 characters.

2.4.273.54 SXAddI_SXCHierarchy_SXDKPIWeight

The **SXAddI_SXCHierarchy_SXDKPIWeight** record specifies the **MDX unique name** of the **OLAP KPI weight measure** for a [pivot hierarchy](#), for a [Sxchierarchy class](#). This record MUST NOT exist if the [PivotCache functionality level](#) of the associated [PivotCache](#) is less than 3.

0	1	2	3	4	5	6	7	8	9	10	11	12	13	14	15	16	17	18	19	20	21	22	23	24	25	26	27	28	29	30	31
hdr																															
...																stKPIWeight (variable)															
...																															

hdr (6 bytes): An [SXAddIHdr](#) structure. The value of **hdr.sxc** MUST equal 0x02 and the value of **hdr.sxd** MUST equal 0x2B.

stKPIWeight (variable): An [SXAddI_SXString](#) structure that specifies the MDX unique name of the KPI weight **Multidimensional Expressions (MDX)**.

The length of this field MUST be greater than or equal to zero characters and less than or equal to 32767 characters.

2.4.273.55 SXAddI_SXCHierarchy_SXDMeasureGrp

The **SXAddI_SXCHierarchy_SXDMeasureGrp** record specifies the name of the **OLAP measure group** for a [pivot hierarchy](#), for a [Sxchierarchy class](#). This record MUST NOT exist if the [PivotCache functionality level](#) of the associated [PivotCache](#) is less than 3.

0	1	2	3	4	5	6	7	8	9	10	11	12	13	14	15	16	17	18	19	20	21	22	23	24	25	26	27	28	29	30	31
hdr																															
...																stMeasureGroup (variable)															
...																															

hdr (6 bytes): An [SXAddIHdr](#) structure. The value of **hdr.sxc** MUST equal 0x02 and the value of **hdr.sxd** MUST equal 0x24.

stMeasureGroup (variable): An [SXAddl_SXString](#) structure that specifies the name of the OLAP measure group.

The length of this field MUST be greater than or equal to zero characters and less than or equal to 65535 characters.

2.4.273.56 SXAddl_SXCHierarchy_SXDParentKPI

The **SXAddl_SXCHierarchy_SXDParentKPI** record specifies the name of the **OLAP** parent **KPI** for a [pivot hierarchy](#), for a [SxCHierarchy class](#). This record MUST NOT exist if the [PivotCache functionality level](#) of the associated [PivotCache](#) is less than 3.

0	1	2	3	4	5	6	7	8	9	10	11	12	13	14	15	16	17	18	19	20	21	22	23	24	25	26	27	28	29	30	31
hdr																															
...																stParentKPI (variable)															
...																															

hdr (6 bytes): An [SXAddlHdr](#) structure. The value of **hdr.sxc** MUST equal 0x02 and the value of **hdr.sxd** MUST equal 0x26.

stParentKPI (variable): An [SXAddl_SXString](#) structure that specifies the name of the parent KPI.

The length of this field MUST be greater than or equal to zero characters and less than or equal to 65535 characters.

2.4.273.57 SXAddl_SXCHierarchy_SXDProperty

The **SXAddl_SXCHierarchy_SXDProperty** record specifies a [member property](#) of a [pivot hierarchy](#) for a [SxCHierarchy class](#). The member property is displayed if the [OLAP PivotTable view](#) is recalculated and the pivot hierarchy is either on the [row axis](#) as specified by the **sxaxis.sxaxisRw** field of [SXTH](#) or on the [column axis](#) as specified by the **sxaxis.sxaxisCol** field of [SXTH](#).

0	1	2	3	4	5	6	7	8	9	10	11	12	13	14	15	16	17	18	19	20	21	22	23	24	25	26	27	28	29	30	31			
hdr																																		
...																A	B	C	reserved1															
...																reserved2																		
cchProperty																stProperty (variable)																		
...																																		
cchLevelUnq																ichPropName																		
cchPropName																isxtl																		

hdr (6 bytes): An [SXAddHdr](#) structure. The value of **hdr.sxc** MUST equal 0x02 and the value of **hdr.sxd** MUST equal 0x05.

A - fDisplayInReport (1 bit): A bit that specifies whether this member property is displayed in the row axis or in the column axis, if this member property is associated with a [pivot field](#).

B - fDisplayInTip (1 bit): A bit that specifies whether this member property is displayed in a **ToolTip**.

C - fDisplayInCaption (1 bit): A bit that specifies whether this member property is used as a caption for [pivot items](#) in the pivot field that is in this pivot hierarchy and is specified by the [SXVDText](#) record with an **isxtl** field equal to the value of the **isxtl** field of this record. MUST be 0 if the [PivotCache functionality level](#) of the associated [PivotCache](#) is less than 3.

reserved1 (29 bits): MUST be zero, and MUST be ignored.

reserved2 (2 bytes): MUST be zero, and MUST be ignored.

cchProperty (2 bytes): An unsigned integer that specifies the length in characters of **stProperty**.

The value MUST be greater than or equal to five characters and less than or equal to 255 characters.

stProperty (variable): An [XLUnicodeStringNoCch](#) that specifies the **MDX unique name** of this member property. If a [cache field](#) has a matching value in the **stFieldName** field of [SXFDB](#), then the cache field is a member property cache field and is associated with this pivot hierarchy.

The length is specified in **cchProperty**.

cchLevelUnq (2 bytes): An unsigned integer that specifies the length in characters of the **OLAP level** MDX unique name of the cache pivot hierarchy in **stProperty**. The OLAP level MDX unique name comes before the member property name in **stProperty**. For example, if the value for **stProperty** equals "[Store].[Store Name].[Store Manager]", then **cchLevelUnq** equals 20. This refers to "[Store].[Store Name]".

If the [PivotCache functionality level](#) of the [associated PivotCache](#) is 3, then this value is undefined and MUST be ignored.

ichPropName (2 bytes): An unsigned integer that specifies the zero-based index of the character where the property name portion begins in **stProperty**. For example, if the value for **stProperty** equals "[Store].[Store Name].[Store Manager]", **ichPropName** equals 22. This refers to the starting character of "Store Manager".

If the [PivotCache functionality level](#) of the associated [PivotCache](#) is 3, then this value is undefined and MUST be ignored.

cchPropName (2 bytes): An unsigned integer that specifies the length in characters of the name portion of **stProperty**. For example, if the value for **stProperty** equals "[Store].[Store Name].[Store Manager]", **cchPropName** equals 13. This refers to the length of "Store Manager".

If the [PivotCache functionality level](#) of the associated [PivotCache](#) is 3, then this value is undefined and MUST be ignored.

isxtl (2 bytes): A signed integer that specifies the zero-based index of the OLAP level in the pivot hierarchy that this property applies to. The value MUST be greater than or equal to -1.

2.4.273.58 SXAddI_SXCHierarchy_SXDSXSetParentUnique

The **SXAddI_SXCHierarchy_SXDSXSetParentUnique** record specifies the **MDX unique name** of the parent [pivot hierarchy](#) for an [SxcHierarchy class](#). This record exists only if this pivot hierarchy is a [named set](#).

0	1	2	3	4	5	6	7	8	9	10	1	2	3	4	5	6	7	8	9	20	1	2	3	4	5	6	7	8	9	30	1		
hdr																																	
...																	stHierUnique (variable)																
...																																	

hdr (6 bytes): An [SXAddIHdr](#) structure. The value of **hdr.sxc** MUST equal 0x02 and the value of **hdr.sxd** MUST equal 0x1D.

stHierUnique (variable): An [SXAddI_SXString](#) structure that specifies the MDX unique name of the parent pivot hierarchy. The length of this field MUST be greater than zero characters and less than or equal to 32767 characters.

2.4.273.59 SXAddI_SXCHierarchy_SXDUserCaption

The **SXAddI_SXCHierarchy_SXDUserCaption** record specifies the user-defined caption for a [pivot hierarchy](#), for a [SxcHierarchy class](#).

0	1	2	3	4	5	6	7	8	9	10	1	2	3	4	5	6	7	8	9	20	1	2	3	4	5	6	7	8	9	30	1		
hdr																																	
...																	stCaption (variable)																
...																																	

hdr (6 bytes): An [SXAddIHdr](#) structure. The value of **hdr.sxc** MUST equal 0x02 and the value of **hdr.sxd** MUST equal 0x1F.

stCaption (variable): An [SXAddI_SXString](#) structure that specifies the user-defined caption of this pivot hierarchy. The length of this field MUST be greater than zero characters and less than or equal to 255 characters.

2.4.273.60 SXAddI_SXCHierarchy_SXDVerUpdInv

The **SXAddI_SXCHierarchy_SXDVerUpdInv** record specifies the record-handling behavior for records of the [SXCHierarchy class](#).

0	1	2	3	4	5	6	7	8	9	10	1	2	3	4	5	6	7	8	9	20	1	2	3	4	5	6	7	8	9	30	1		
data																																	
...																																	

...

data (12 bytes): An [SXAddl_SXDVerUpdInv](#). The value of **data.hdr.sxc** MUST equal 0x02 and the value of **data.hdr.sxd** MUST equal 0x01.

If the value of **data.dwVersionInvalidates** is not 0x00FF and is greater than or equal to the value of the **VerSxLastUpdated** field of the [QsiSxTag](#) record of this [PivotTable view](#), then all the records and nested records of this SXHierarchy class MUST be ignored until another SXAddl_SXHierarchy_SXDVerUpdInv record is encountered.

2.4.273.61 SXAddl_SXCQsi_SXDEnd

The **SXAddl_SXCQsi_SXDEnd** record specifies the end of a [SxcQsi class](#).

0	1	2	3	4	5	6	7	8	9	10	11	12	13	14	15	16	17	18	19	20	21	22	23	24	25	26	27	28	29	30	31
hdr																															
...																reserved															
...																															

hdr (6 bytes): An [SXAddlHdr](#) structure. The value of **hdr.sxc** MUST equal 0x05 and the value of **hdr.sxd** MUST equal 0xFF.

reserved (6 bytes): MUST be zero, and MUST be ignored.

2.4.273.62 SXAddl_SXCQsi_SXDId

The **SXAddl_SXCQsi_SXDId** record specifies how a [SxcQsi class](#) is associated with other records for a **query table**.

0	1	2	3	4	5	6	7	8	9	10	11	12	13	14	15	16	17	18	19	20	21	22	23	24	25	26	27	28	29	30	31
hdr																															
...																stName (variable)															
...																															

hdr (6 bytes): An [SXAddlHdr](#) structure. The value of **hdr.sxc** MUST equal 0x05 and the value of **hdr.sxd** MUST equal 0x00.

stName (variable): A [SXAddl_SXString](#) structure that specifies the name of the query table. If the **stName** field equals the **rgchName** field of a [Qsi](#) record in this [worksheet](#) substream, then this SxcQsi class applies to the query table that the Qsi record is associated with. Otherwise, this SxcQsi class MUST be ignored.

2.4.273.63 SXAddl_SXCQuery_SXDEnd

The **SXAddl_SXCQuery_SXDEnd** record specifies the end of a [SxcQuery class](#).

0	1	2	3	4	5	6	7	8	9	10	11	12	13	14	15	16	17	18	19	20	21	22	23	24	25	26	27	28	29	30	31
hdr																															
...																reserved															
...																															

hdr (6 bytes): An [SXAddlHdr](#) structure. The value of **hdr.sxc** MUST equal 0x07 and the value of **hdr.sxd** MUST equal 0xFF.

reserved (6 bytes): MUST be zero, and MUST be ignored.

2.4.273.64 SXAddl_SXCQuery_SXDReconnCond

The **SXAddl_SXCQuery_SXDReconnCond** record specifies the **reconnect condition** for an [external connection](#), for a [SxcQuery class](#).

0	1	2	3	4	5	6	7	8	9	10	11	12	13	14	15	16	17	18	19	20	21	22	23	24	25	26	27	28	29	30	31
hdr																															
...																rccDBQuery															
...																reserved															

hdr (6 bytes): An [SXAddlHdr](#) structure. The value of **hdr.sxc** MUST equal 0x06 and the value of **hdr.sxd** MUST equal 0x07.

rccDBQuery (4 bytes): An unsigned integer that specifies the reconnect condition for the database **query**. MUST be a value from the following table:

Value	Reconnect condition
0x00000000	Retrieve external connection information as required. When external data is refreshed from the external connection, use the existing external connection information; if the external data refresh from the external connection fails, then retrieve updated external connection information, if available, from the external connection file .
0x00000001	Retrieve external connection information. When external data is refreshed from the external connection, retrieve updated external connection information from the external connection file, if available, and use that instead of the existing external connection information. In this case, the external data refresh fails if the external connection file is unavailable.
0x00000000	Never retrieve external connection information. Never get updated external connection information from the external connection file even if it is available and even if the existing external connection information is not valid.

reserved (2 bytes): MUST be zero, and MUST be ignored.

2.4.273.65 SXAddI_SXCQuery_SXDSrcConnFile

The **SXAddI_SXCQuery_SXDSrcConnFile** record specifies the [external connection file](#) for an [external connection](#), for a [SxcQuery class](#).

0	1	2	3	4	5	6	7	8	9	10	11	12	13	14	15	16	17	18	19	20	21	22	23	24	25	26	27	28	29	30	31
hdr																															
...																stSourceConnectionFile (variable)															
...																															

hdr (6 bytes): An [SXAddIHdr](#) structure. The value of **hdr.sxc** MUST equal 0x06 and the value of **hdr.sxd** MUST equal 0x06.

stSourceConnectionFile (variable): An [SXAddI_SXString](#) that specifies the external connection file for the database **query**. The total count of characters of the string MUST be less than or equal to 65535.

2.4.273.66 SXAddI_SXCQuery_SXDSrcDataFile

The **SXAddI_SXCQuery_SXDSrcDataFile** record specifies the **source data** file for an [external connection](#), for a [SxcQuery class](#).

0	1	2	3	4	5	6	7	8	9	10	11	12	13	14	15	16	17	18	19	20	21	22	23	24	25	26	27	28	29	30	31
hdr																															
...																stSourceDataFile (variable)															
...																															

hdr (6 bytes): An [SXAddIHdr](#) structure. The value of **hdr.sxc** MUST equal 0x06 and the value of **hdr.sxd** MUST equal 0x05.

stSourceDataFile (variable): An [SXAddI_SXString](#) structure that specifies the source data file for the database **query**. The total count of characters of the string MUST be less than or equal to 65535.

2.4.273.67 SXAddI_SXCQuery_SXDXMLSource

The **SXAddI_SXCQuery_SXDXMLSource** record specifies the **Uniform Resource Locator (URL)**, used to display an edit dialog for an [external connection](#), for a [SxcQuery class](#).

0	1	2	3	4	5	6	7	8	9	10	11	12	13	14	15	16	17	18	19	20	21	22	23	24	25	26	27	28	29	30	31
hdr																															

...	stURL (variable)
...	

hdr (6 bytes): An [SXAddlHdr](#) structure The value of **hdr.sxc** MUST equal 0x06 and the value of **hdr.sxd** MUST equal 0x04.

stURL (variable): An [XLUnicodeStringSegmentedSXAddl](#) that specifies the URL used to display an edit dialog.

2.4.273.68 SXAddl_SXCSXCondFmt_SXDEnd

The **SXAddl_SXCSXCondFmt_SXDEnd** record specifies the end of a [SXCSXCondFmt class](#).

0	1	2	3	4	5	6	7	8	9	10	11	12	13	14	15	16	17	18	19	20	21	22	23	24	25	26	27	28	29	30	31
hdr																															
...																reserved															
...																															

hdr (6 bytes): An [SXAddlHdr](#) structure. The value of **hdr.sxc** MUST equal 0x1B and the value of **hdr.sxd** MUST equal 0xFF.

reserved (6 bytes): MUST be zero, and MUST be ignored.

2.4.273.69 SXAddl_SXCSXCondFmt_SXDSXCondFmt

The **SXAddl_SXCSXCondFmt_SXDSXCondFmt** record specifies information for a [PivotTable conditional formatting](#) rule, for a [SXCSXCondFmt class](#).

0	1	2	3	4	5	6	7	8	9	10	11	12	13	14	15	16	17	18	19	20	21	22	23	24	25	26	27	28	29	30	31
hdr																															
...																reserved															
...																															
sxcondfmtScope																															
sxcondfmtType																															
ipriority																															
csxrule																															

hdr (6 bytes): An [SXAddlHdr](#) structure. The value of **hdr.sxc** MUST equal 0x1B and the value of **hdr.sxd** MUST equal 0x35.

reserved (6 bytes): MUST be zero, and MUST be ignored.

sxcondfmtScope (4 bytes): An unsigned integer that specifies the scope of the [PivotTable view](#) conditional formatting. MUST be a value from the following table:

Name	Value	Description
SXCONDFMTSELECTIONSCOPE	0x00000000	This conditional formatting is applied to the cells , as specified by the SXCSXrule classes contained in this SXCSXCondFmt class.
SXCONDFMTDATASCOPE	0x00000001	This conditional formatting is applied to all cells that display values for the data item , as specified by the SXCSXrule class contained in this SXCSXCondFmt class.
SXCONDFMTFIELDSCOPE	0x00000002	This conditional formatting is applied to all cells that display values for the pivot field intersections, as specified by the SXCSXrule class contained in this SXCSXCondFmt class.

The value MUST be SXCONDFMTFIELDSCOPE if the value of **sxcondfmtType** is SXCONDFMTTOP10R or SXCONDFMTTOP10C.

If the value is SXCONDFMTDATASCOPE or SXCONDFMTFIELDSCOPE, there MUST be only one SXCSXrule class contained in this SXCSXCondFmt class.

sxcondfmtType (4 bytes): An unsigned integer that specifies the type of this PivotTable view conditional formatting. MUST be one of the values from following table:

Name	Value	Description
SXCONDFMTTOP10NIL	0x00000000	Top N or Bottom N conditional formatting is not evaluated.
SXCONDFMTTOP10A	0x00000001	Top N or Bottom N conditional formatting is evaluated across the entire scope range .
SXCONDFMTTOP10R	0x00000002	Top N or Bottom N conditional formatting is evaluated for each row.
SXCONDFMTTOP10C	0x00000003	Top N or Bottom N conditional formatting is evaluated for each column.

The value MUST be equal to SXCONDFMTTOP10NIL or SXCONDFMTTOP10A if the value of **sxcondfmtScope** is SXCONDFMTSELECTIONSCOPE or SXCONDFMTDATASCOPE.

ipriority (4 bytes): An unsigned integer that specifies the priority of the PivotTable view conditional formatting. It is used to locate the conditional formatting rule by matching the **ipriority** field of either [CF12](#) or the **rgbContent** field which is a [CFExNonCF12](#) structure in [CFEx](#). MUST be greater than or equal to 1.

csxrule (4 bytes): An unsigned integer that specifies the number of SXCSXrule classes contained in this SXCSXCondFmt class. The SXCSXrule classes specify the area that the conditional formatting is applied to.

2.4.273.70 SXAddl_SXCSXCondFmts_SXDEnd

The **SXAddl_SXCSXCondFmts_SXDEnd** record specifies the end of a [SXCSXCondFmts class](#).

0	1	2	3	4	5	6	7	8	9	10	1	2	3	4	5	6	7	8	9	20	1	2	3	4	5	6	7	8	9	30	1	
hdr																																

...	reserved
...	

hdr (6 bytes): An [SXAddlHdr](#) structure. The value of **hdr.sxc** MUST equal 0x1A and the value of **hdr.sxd** MUST equal 0xFF.

reserved (6 bytes): MUST be zero, and MUST be ignored.

2.4.273.71 SXAddl_SXCSXCondFmts_SXDId

The **SXAddl_SXCSXCondFmts_SXDId** record specifies information for [PivotTable conditional formatting](#) rules, for a [SXCSXCondFmts class](#).

0	1	2	3	4	5	6	7	8	9	10	11	12	13	14	15	16	17	18	19	20	21	22	23	24	25	26	27	28	29	30	31
hdr																															
...																cSxcondfmt															
...																reserved															

hdr (6 bytes): An [SXAddlHdr](#) structure. The value of **hdr.sxc** MUST equal 0x1A and the value of **hdr.sxd** MUST equal 0x00.

cSxcondfmt (4 bytes): A signed integer that specifies the number of [SXCSXCondFmt class](#) instances that follow this record. MUST be greater than 0.

reserved (2 bytes): MUST be zero, and MUST be ignored.

2.4.273.72 SXAddl_SXCSXDH_SXDEnd

The **SXAddl_SXCSXDH_SXDEnd** record specifies the end of an [SXCSXDH class](#).

0	1	2	3	4	5	6	7	8	9	10	11	12	13	14	15	16	17	18	19	20	21	22	23	24	25	26	27	28	29	30	31
hdr																															
...																reserved															
...																															

hdr (6 bytes): An [SXAddlHdr](#) structure. The value of **hdr.sxc** MUST equal 0x10 and the value of **hdr.sxd** MUST equal 0xFF.

reserved (6 bytes): MUST be zero, and MUST be ignored.

2.4.273.73 SXAddI_SXCSXDH_SXDId

The **SXAddI_SXCSXDH_SXDId** record specifies information for an **OLAP dimension (1)** for a [SXCSXDH class](#).

0	1	2	3	4	5	6	7	8	9	10	11	12	13	14	15	16	17	18	19	20	21	22	23	24	25	26	27	28	29	30	31
hdr																															
...																dwCount															
...																reserved															

hdr (6 bytes): An [SXAddIHdr](#) structure. The value of **hdr.sxc** MUST equal 0x10 and the value of **hdr.sxd** MUST equal 0x00.

dwCount (4 bytes): An unsigned integer that specifies the number of [SXAddI](#) records of type [SXADDL_SXCSXDH_SXDSXDH](#) that follow this record. The count MUST be greater than zero and less than 0xFFFFFFFF.

reserved (2 bytes): MUST be zero, and MUST be ignored.

2.4.273.74 SXAddI_SXCSXDH_SXDSxdh

The **SXAddI_SXCSXDH_SXDSxdh** record specifies a mapping between an **OLAP dimension (1)** and a [pivot hierarchy](#) for a [SXCSXDH class](#).

0	1	2	3	4	5	6	7	8	9	10	11	12	13	14	15	16	17	18	19	20	21	22	23	24	25	26	27	28	29	30	31
hdr																															
...																reserved1															
...																reserved2															
isxth																															
cchDimensionName																cchDimensionUnique															
cchDimensionCaption																stDimensionName (variable)															
...																															
stDimensionUnique (variable)																															
...																															
stDimensionCaption (variable)																															

...

hdr (6 bytes): An [SXAddlHdr](#) structure. The value of **hdr.sxc** MUST equal 0x10 and the value of **hdr.sxd** MUST equal 0x1A.

reserved1 (4 bytes): MUST be zero, and MUST be ignored.

reserved2 (2 bytes): MUST be zero, and MUST be ignored.

isxth (4 bytes): A signed integer that specifies a reference to a pivot hierarchy. MUST be a value from the following table:

Value	Meaning
-2	This value specifies the data field .
0+	A pivot hierarchy index, as specified in Pivot Hierarchies, that specifies a pivot hierarchy in the associated PivotTable view of the OLAP PivotCache .

The value MUST be -2 or greater than or equal to zero and less than the number of pivot hierarchy in the associated PivotTable view of the OLAP PivotCache.

cchDimensionName (2 bytes): An unsigned integer that specifies the length, in characters, of the [XLUnicodeStringNoCch](#) in the **stDimensionName** field. MUST be greater than zero and less than or equal to 0x00FF.

cchDimensionUnique (2 bytes): An unsigned integer that specifies the length, in characters, of the [XLUnicodeStringNoCch](#) in the **stDimensionUnique** field. MUST be greater than zero and less than or equal to 0x00FF.

cchDimensionCaption (2 bytes): An unsigned integer that specifies the length, in characters, of the [XLUnicodeStringNoCch](#) in the **stDimensionCaption** field. MUST be greater than zero and less than or equal to 0x00FF.

stDimensionName (variable): An [XLUnicodeStringNoCch](#) that specifies the name of the OLAP dimension (1). The length is specified in **cchDimensionName**.

stDimensionUnique (variable): An [XLUnicodeStringNoCch](#) that specifies the fully qualified unique name of the **cube** dimension (1). The length is specified in **cchDimensionUnique**.

stDimensionCaption (variable): An [XLUnicodeStringNoCch](#) that specifies the caption of the OLAP dimension (1). The length is specified in **cchDimensionCaption**.

2.4.273.75 SXAddl_SXCSXfilt_SXDEnd

The **SXAddl_SXCSXfilt_SXDEnd** record specifies the end of an [SXCSXfilt class](#).

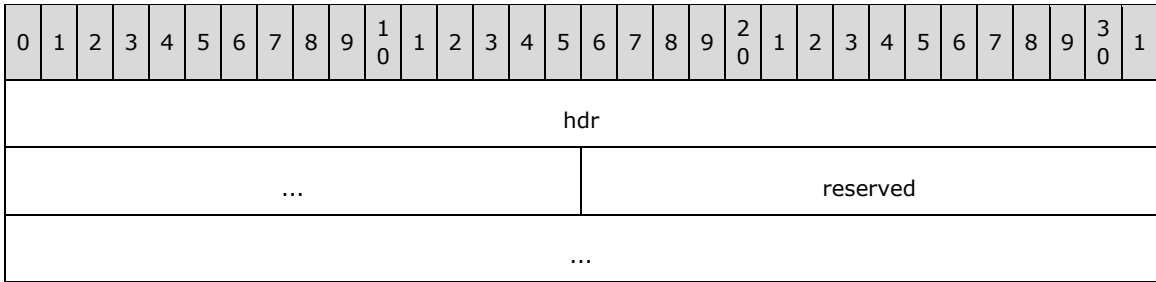

hdr (6 bytes): An [SXAddlHdr](#) structure. The value of **hdr.sxc** MUST equal 0x0D and the value of **hdr.sxd** MUST equal 0xFF.

reserved (6 bytes): MUST be zero, and MUST be ignored.

2.4.273.76 SXAddI_SXCSXfilt_SXDId

The **SXAddI_SXCSXfilt_SXDId** record specifies information for a [PivotTable rule](#) filter, for an [SXCSXfilt class](#).

0	1	2	3	4	5	6	7	8	9	10	11	12	13	14	15	16	17	18	19	20	21	22	23	24	25	26	27	28	29	30	31
hdr																															
...																reserved															
...																															

hdr (6 bytes): An [SXAddIHdr](#) structure. The value of **hdr.sxc** MUST equal 0x0D and the value of **hdr.sxd** MUST equal 0x00.

reserved (6 bytes): MUST be zero, and MUST be ignored.

2.4.273.77 SXAddI_SXCSXfilt_SXDSXfilt

The **SXAddI_SXCSXfilt_SXDSXfilt** record specifies information for a [PivotTable rule](#) filter, for an [SXCSXfilt class](#).

0	1	2	3	4	5	6	7	8	9	10	11	12	13	14	15	16	17	18	19	20	21	22	23	24	25	26	27	28	29	30	31				
hdr																																			
...																reserved1																			
...																																			
A	B	C	D	E	F	G	reserved5														grbitSbt														
iDim																																			
isxvd																																			
cisxvi																																			

hdr (6 bytes): An [SXAddIHdr](#) structure. The value of **hdr.sxc** MUST equal 0x0D and the value of **hdr.sxd** MUST equal 0x14.

reserved1 (6 bytes): MUST be zero, and MUST be ignored.

A - sxaxisRw (1 bit): A bit that specifies whether the [row axis](#) is being referred to.

MUST be zero if the value of **sxaxisCol** is 1 or the value of **sxaxisPage** is 1 or the value of **sxaxisData** is 1.

B - sxaxisCol (1 bit): A bit that specifies whether the [column axis](#) is being referred to.

MUST be zero if the value of **sxaxisRw** is 1 or the value of **sxaxisPage** is 1 or the value of **sxaxisData** is 1.

C - reserved2 (1 bit): MUST be zero, and MUST be ignored.

D - sxaxisData (1 bit): A bit that specifies whether the [value axis](#) is being referred to.

MUST be zero if the value of **sxaxisRw** is 1 or the value of **sxaxisCol** is 1 or the value of **sxaxisPage** is 1.

E - fSelected (1 bit): A bit that specifies whether the header of the [Pivot Field](#) is included in the PivotTable rule filters.

F - reserved3 (1 bit): MUST be zero, and MUST be ignored.

G - reserved4 (1 bit): MUST be zero, and MUST be ignored.

reserved5 (9 bits): MUST be zero, and MUST be ignored.

grbitSbt (2 bytes): A signed integer that specifies the subtotals for this PivotTable rule filter. MUST be a value from the following table:

Value	Meaning
0	No subtotals are displayed.
1	Data value subtotals are displayed.

iDim (4 bytes): A signed integer that specifies the position of the Pivot Field within the axis specified by **sxaxisRw**, **sxaxisCol**, **sxaxisPage**, or **sxaxisData**. MUST be greater than or equal to -1 and less than or equal to 0x0000001F.

isxvd (4 bytes): A signed integer that specifies the Pivot Field that this PivotTable rule filter refers to. MUST be a value from the following table:

Value	Meaning
-2	This PivotTable rule filter refers to the data field .
-1	This PivotTable rule filter does not refer to a pivot field
0 to 255	This value specifies a pivot field index, as specified in Pivot Fields. The pivot field index specifies which pivot field this PivotTable rule filter refers to.

If the value is greater than or equal to zero, MUST be less than the number of pivot fields in the [PivotTable view](#).

cisxvi (4 bytes): An unsigned integer that specifies the count of [pivot item](#) indexes in the [SXAddl_SXCSXfilt_SXDSXItm](#) record that follows this record. MUST be greater than or equal to zero. If **isxvd** is -1, MUST be 0.

2.4.273.78 SXAddl_SXCSXfilt_SXDSXItm

The **SXAddl_SXCSXfilt_SXDSXItm** record specifies an array of [pivot item](#) records of a [PivotTable rule](#) filter for an [SXCSXfilt class](#).

0	1	2	3	4	5	6	7	8	9	10	11	12	13	14	15	16	17	18	19	20	21	22	23	24	25	26	27	28	29	30	31
hdr																															
...																reserved															
...																															
rgIsxvi (variable)																															
...																															

hdr (6 bytes): An [SXAddlHdr](#) structure. The value of **hdr.sxc** MUST equal 0x0D and the value of **hdr.sxd** MUST equal 0x15.

reserved (6 bytes): MUST be zero, and MUST be ignored.

rgIsxvi (variable): An array of 2-byte unsigned integers. Each element specifies the pivot item or [data item](#) index in the [pivot field](#) or [data field](#) specified by the **isxvd** field of the preceding [SXAddl_SXCSXfilt_SXDSXfilt](#) record. See PivotTable rule for more information about the references that are used.

The number of items in the array MUST equal the **cisxvi** field of the preceding [SXAddl_SXCSXfilt_SXDSXfilt](#) record.

The value of each element in **rgIsxvi** MUST be in sorted order such that **rgIsxvi**[item] is less than **rgIsxvi**[item+1] where item is between 0 and the number of elements in **rgIsxvi** - 2.

If the value of the **isxvd** field of the preceding [SXAddl_SXCSXfilt_SXDSXfilt](#) record is greater than or equal to zero, each item in this array MUST be 0x7FFF (isxviNULL) or greater than or equal to zero plus the number of pivot items in the pivot field specified by the **isxvd** field of the preceding [SXAddl_SXCSXfilt_SXDSXfilt](#) record.

If the value of the **isxvd** field of the preceding [SXAddl_SXCSXfilt_SXDSXfilt](#) record is less than zero, each item in this array MUST be greater than or equal to zero and less than the number of data items in the [PivotTable view](#).

2.4.273.79 SXAddl_SXCSXFilter12_SXDCaption

The **SXAddl_SXCSXFilter12_SXDCaption** record specifies the name of the [advanced filter](#) for an [SXCSXFilter12 class](#).

0	1	2	3	4	5	6	7	8	9	10	11	12	13	14	15	16	17	18	19	20	21	22	23	24	25	26	27	28	29	30	31
hdr																															
...																stName (variable)															
...																															

hdr (6 bytes): An [SXAddlHdr](#) structure. The value of **hdr.sxc** MUST equal 0x1D and the value of **hdr.sxd** MUST equal 0x2F.

stName (variable): An [SXAddl_SXString](#) structure that specifies the name of the [PivotTable view filter](#).

2.4.273.80 SXAddl_SXCSXFilter12_SXDEnd

The **SXAddl_SXCSXFilter12_SXDEnd** record specifies the end of an [SXCSXFilter12 class](#).

0	1	2	3	4	5	6	7	8	9	10	11	12	13	14	15	16	17	18	19	20	21	22	23	24	25	26	27	28	29	30	31
hdr																															
...																reserved															
...																															

hdr (6 bytes): An [SXAddlHdr](#) structure. The value of **hdr.sxc** MUST equal 0x1D and the value of **hdr.sxd** MUST equal 0xFF.

reserved (6 bytes): MUST be zero, and MUST be ignored.

2.4.273.81 SXAddl_SXCSXFilter12_SXDId

The **SXAddl_SXCSXFilter12_SXDId** record specifies information for an [advanced filter](#), for an [SXCSXFilter12 class](#).

0	1	2	3	4	5	6	7	8	9	10	11	12	13	14	15	16	17	18	19	20	21	22	23	24	25	26	27	28	29	30	31
hdr																															
...																dwFilterid															
...																reserved															

hdr (6 bytes): An [SXAddlHdr](#) structure. The value of **hdr.sxc** MUST equal 0x1D and the value of **hdr.sxd** MUST equal 0x00.

dwFilterid (4 bytes): An unsigned integer that specifies the unique identifier of this **filter**.

reserved (2 bytes): MUST be zero, and MUST be ignored.

2.4.273.82 SXAddl_SXCSXFilter12_SXDSXFilter

The **SXAddl_SXCSXFilter12_SXDSXFilter** record specifies the **filter** information of an [advanced filter](#) for an [SXCSXFilter12 class](#).

0	1	2	3	4	5	6	7	8	9	10	11	12	13	14	15	16	17	18	19	20	21	22	23	24	25	26	27	28	29	30	31
hdr																															

...	reserved1
...	reserved2
isxvd	
isxvdMProp	
sxft	
unused	
isxdiMeasure	
isxthMeasure	

hdr (6 bytes): An [SXAddlHdr](#) structure. The value of **hdr.sxc** MUST equal 0x1D and the value of **hdr.sxd** MUST equal 0x38.

reserved1 (4 bytes): MUST be zero and MUST be ignored.

reserved2 (2 bytes): MUST be zero and MUST be ignored.

isxvd (4 bytes): An unsigned integer that specifies a [pivot field](#) index as specified in pivot fields. The pivot field index specifies which pivot field this filter applies to. The value MUST be less than the **cDim** field of the [SxView](#) record of this [PivotTable view](#).

isxvdMProp (4 bytes): A signed integer that specifies the [member property](#) pivot field on which this advanced filter is based. MUST be a value from the following table:

Value	Meaning
-1	This advanced filter is not defined on a member property .
Greater than or equal to zero	This value specifies a pivot field index as specified in pivot fields. The pivot field index specifies which pivot field this advanced filter is based on.

This value MUST be -1 and MUST be ignored if the value of the **sxft** field is less than 0x00000004 or greater than 0x00000011. The value MUST be greater than or equal to -1 and less than the value of the **cDim** field of the SxView record of this PivotTable view.

sxft (4 bytes): A [SxFT](#) structure that specifies the advanced filter type. If the value is equal to SXFTCOUNT, SXFTPERCENT, or SXFTSUM, the **cft** field in [SXAddl SXCSXFilter12 SXDXIsFilter](#) MUST be equal to CFTTOP10.

unused (4 bytes): Undefined and MUST be ignored.

isxdiMeasure (4 bytes): A signed integer that specifies a [data item](#) index of the data item on which this advanced filter is based. If this is an [OLAP PivotTable view](#) then isxdiMeasure MUST be -1, if this is a [value filter](#) then isxdiMeasure MUST be greater than or equal to zero and less than the number of [SXDI](#) records in this PivotTable view. Otherwise isxdiMeasure MUST be 0.

isxthMeasure (4 bytes): A signed integer that specifies a [pivot hierarchy](#) index of the [measure](#) pivot hierarchy on which this advanced filter applies. If this is a non-OLAP PivotTable view then isxthMeasure MUST be -1. If this is a value filter then **isxthMeasure** MUST be greater than or equal to zero and less than the number of [SxTH](#) records in this PivotTable view. Otherwise isxthMeasure MUST be 0.

2.4.273.83 SXAddl_SXCSXFilter12_SXDSXFilterDesc

The **SXAddl_SXCSXFilter12_SXDSXFilterDesc** record specifies the description of an [advanced filter](#) for an [SXCSXFilter12 class](#).

0	1	2	3	4	5	6	7	8	9	10	11	12	13	14	15	16	17	18	19	20	21	22	23	24	25	26	27	28	29	30	31
hdr																															
...																stDescription (variable)															
...																															

hdr (6 bytes): An [SXAddlHdr](#) structure. The value of **hdr.sxc** MUST equal 0x1D and the value of **hdr.sxd** MUST equal 0x39.

stDescription (variable): A [SXAddl_SXString](#) structure that specifies the description of the [PivotTable view filter](#).

2.4.273.84 SXAddl_SXCSXFilter12_SXDSXFilterValue1

The **SXAddl_SXCSXFilter12_SXDSXFilterValue1** record specifies the first value used by the [label filter](#) for an [SXCSXFilter12 class](#). This record MUST NOT exist if the value of the **sxft** field of the preceding [SXAddl_SXCSXFilter12_SXDSXFilter](#) record is less than 0x00000004 or greater than 0x00000011.

0	1	2	3	4	5	6	7	8	9	10	11	12	13	14	15	16	17	18	19	20	21	22	23	24	25	26	27	28	29	30	31
hdr																															
...																stValue (variable)															
...																															

hdr (6 bytes): An [SXAddlHdr](#) structure. The value of **hdr.sxc** MUST equal 0x1D and the value of **hdr.sxd** MUST equal 0x3A.

stValue (variable): A [SXAddl_SXString](#) structure that specifies the first value used by the label filter.

2.4.273.85 SXAddl_SXCSXFilter12_SXDSXFilterValue2

The **SXAddl_SXCSXFilter12_SXDSXFilterValue2** record specifies the second value used by the [label filter](#) for an [SXCSXFilter12 class](#). This record MUST NOT exist if the value of the **sxft** field of the preceding [SXAddl_SXCSXFilter12_SXDSXFilter](#) record is less than 0x00000004 or greater than 0x00000011.

0	1	2	3	4	5	6	7	8	9	10	11	12	13	14	15	16	17	18	19	20	21	22	23	24	25	26	27	28	29	30	31
hdr																															
...																stValue (variable)															

...

hdr (6 bytes): An [SXAddlHdr](#) structure. The value of **hdr.sxc** MUST equal 0x1D and the value of **hdr.sxd** MUST equal 0x3B.

stValue (variable): A [SXAddl_SXString](#) structure that specifies the second value used by the label filter.

2.4.273.86 SXAddl_SXCSXFilter12_SDXIsFilter

The **SXAddl_SXCSXFilter12_SDXIsFilter** record specifies information for an [advanced filter](#), for an [SXCSXFilter12 class](#).

0	1	2	3	4	5	6	7	8	9	10	11	12	13	14	15	16	17	18	19	20	21	22	23	24	25	26	27	28	29	30	31
hdr																															
...															reserved																
...																															
cft																															
ccriteria																															
data (28 bytes)																															
...																															
...																															

hdr (6 bytes): An [SXAddlHdr](#) structure. The value of **hdr.sxc** MUST equal 0x1D and the value of **hdr.sxd** MUST equal 0x3C.

reserved (6 bytes): MUST be zero, and MUST be ignored.

cft (4 bytes): A [CFT](#) enumeration that specifies the **custom filter** type. If the **sxft** field in [SXAddl_SXCSXFilter12_SXDSXFilter](#) is equal to SXFTCOUNT, SXFTPERCENT, or SXFTSUM, this value MUST be CFTTOP10.

ccriteria (4 bytes): A signed integer that specifies the number of criteria. MUST be greater than or equal to zero and less than or equal to 2.

data (28 bytes): A 28-byte structure that contains the **filter** data.

If **cft** equals CFTTOP10 this is an [XlsFilter_Top10](#) structure, otherwise this is an [XlsFilter_Criteria](#) structure.

2.4.273.87 SXAddl_SXCSXFilter12_SDXIsFilterValue1

The **SXAddl_SXCSXFilter12_SDXIsFilterValue1** record specifies the first value of an [advanced filter](#) for an [SXCSXFilter12 class](#).

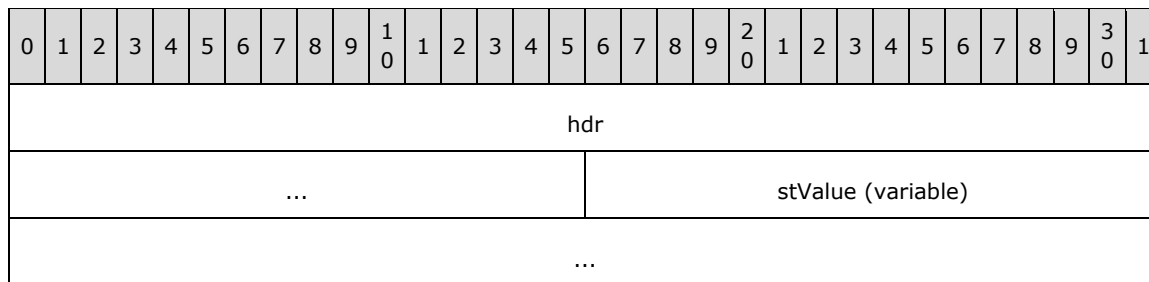

hdr (6 bytes): An [SXAddlHdr](#) structure. The value of **hdr.sxc** MUST equal 0x1D and the value of **hdr.sxd** MUST equal 0x3D.

stValue (variable): A [SXAddl SXString](#) structure that specifies the first value string of the [SXAddl SXCSXFilter12 SXDXIsFilter filter](#).

2.4.273.88 SXAddl_SXCSXFilter12_SXDXIsFilterValue2

The **SXAddl_SXCSXFilter12_SXDXIsFilterValue2** record specifies the second value of an [advanced filter](#) for an [SXCSXFilter12 class](#).

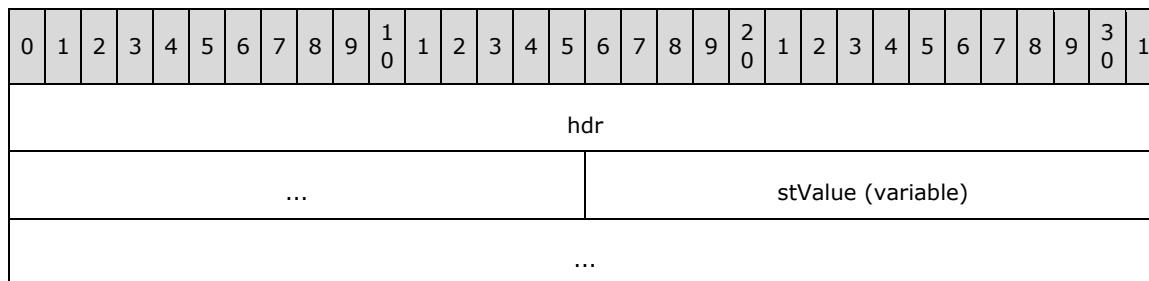

hdr (6 bytes): An [SXAddlHdr](#) structure. The value of **hdr.sxc** MUST equal 0x1D and the value of **hdr.sxd** MUST equal 0x3E.

stValue (variable): A [SXAddl SXString](#) structure that specifies the second value of the [SXAddl SXCSXFilter12 SXDXIsFilter filter](#).

2.4.273.89 SXAddl_SXCSXFilters12_SXDEnd

The **SXAddl_SXCSXFilters12_SXDEnd** record specifies the end of an [SXCSXFilters12 class](#).

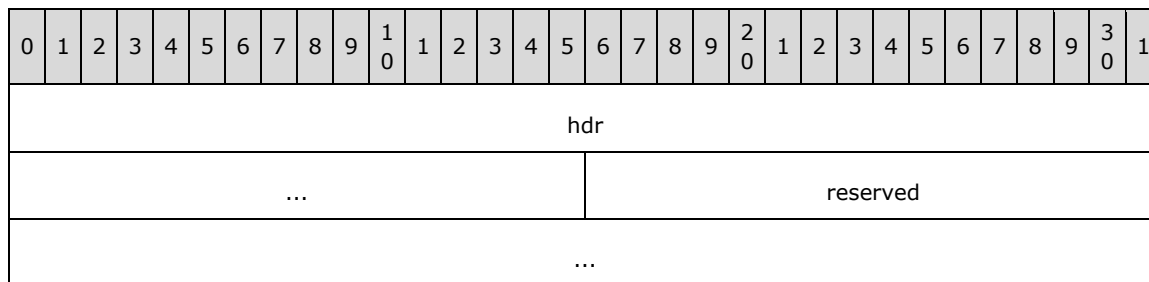

hdr (6 bytes): An [SXAddlHdr](#) structure. The value of **hdr.sxc** MUST equal 0x1C and the value of **hdr.sxd** MUST equal 0xFF.

reserved (6 bytes): MUST be zero, and MUST be ignored.

2.4.273.90 SXAddI_SXCSXFilters12_SXDId

The **SXAddI_SXCSXFilters12_SXDId** record specifies information for [advanced filters](#), for an [SXCSXFilters12 class](#).

0	1	2	3	4	5	6	7	8	9	10	11	12	13	14	15	16	17	18	19	20	21	22	23	24	25	26	27	28	29	30	31
hdr																															
...																cSxfilter12															
...																reserved															

hdr (6 bytes): An [SXAddIHdr](#) structure. The value of **hdr.sxc** MUST equal 0x1C and the value of **hdr.sxd** MUST equal 0x00.

cSxfilter12 (4 bytes): An unsigned integer that specifies the count of PivotTable advanced filters in the **sheet**.

reserved (2 bytes): MUST be zero, and MUST be ignored.

2.4.273.91 SXAddI_SXCSXMg_SXDEnd

The **SXAddI_SXCSXMg_SXDEnd** record specifies the end of an [SXCSXMg class](#).

0	1	2	3	4	5	6	7	8	9	10	11	12	13	14	15	16	17	18	19	20	21	22	23	24	25	26	27	28	29	30	31
hdr																															
...																reserved															
...																															

hdr (6 bytes): An [SXAddIHdr](#) structure. The value of **hdr.sxc** MUST equal 0x14 and the value of **hdr.sxd** MUST equal 0xFF.

reserved (6 bytes): MUST be zero, and MUST be ignored.

2.4.273.92 SXAddI_SXCSXMg_SXDId

The **SXAddI_SXCSXMg_SXDId** record specifies information for an **OLAP measure group**, for an [SXCSXMg class](#).

0	1	2	3	4	5	6	7	8	9	10	11	12	13	14	15	16	17	18	19	20	21	22	23	24	25	26	27	28	29	30	31
hdr																															

...	stName (variable)
...	

hdr (6 bytes): An [SXAddlHdr](#) structure. The value of **hdr.sxc** MUST equal 0x14 and the value of **hdr.sxd** MUST equal 0x00.

stName (variable): An [SXAddl_SXString](#) structure that specifies the name of the OLAP measure group.

2.4.273.93 SXAddl_SXCSXMg_SXDUserCaption

The **SXAddl_SXCSXMg_SXDUserCaption** record specifies the display name for the **OLAP measure group** specified in this [SXAddl](#) record collection.

0	1	2	3	4	5	6	7	8	9	10	11	12	13	14	15	16	17	18	19	20	21	22	23	24	25	26	27	28	29	30	31
hdr																															
...																stUserCaption (variable)															
...																															

hdr (6 bytes): An [SXAddlHdr](#) structure. The value of **hdr.sxc** MUST equal 0x14 and the value of **hdr.sxd** MUST equal 0x1F.

stUserCaption (variable): An [SXAddl_SXString](#) structure that specifies the display name of the OLAP measure group.

2.4.273.94 SXAddl_SXCSXMgs_SXDEnd

The **SXAddl_SXCSXMgs_SXDEnd** record specifies the end of an [SxcSXMgs class](#).

0	1	2	3	4	5	6	7	8	9	10	11	12	13	14	15	16	17	18	19	20	21	22	23	24	25	26	27	28	29	30	31
hdr																															
...																reserved															
...																															

hdr (6 bytes): An [SXAddlHdr](#) structure. The value of **hdr.sxc** MUST equal 0x13 and the value of **hdr.sxd** MUST equal 0xFF.

reserved (6 bytes): MUST be zero, and MUST be ignored.

2.4.273.95 SXAddl_SXCSXMgs_SXDId

The **SXAddl_SXCSXMgs_SXDId** record specifies information for an **OLAP measure group** collection, for an [SxcSXMgs class](#).

0	1	2	3	4	5	6	7	8	9	10	11	12	13	14	15	16	17	18	19	20	21	22	23	24	25	26	27	28	29	30	31
hdr																															
...															cmgs																
...															reserved																
cmaps																															

hdr (6 bytes): An [SXAddlHdr](#) structure. The value of **hdr.sxc** MUST equal 0x13 and the value of **hdr.sxd** MUST equal 0x00.

cmgs (4 bytes): An unsigned integer that specifies the number of OLAP measure groups in the OLAP measure group collection. MUST be equal to the number of [SXCSXMg classes](#) that are nested inside this SxcSXMgs class.

reserved (2 bytes): MUST be zero, and MUST be ignored.

cmaps (4 bytes): An unsigned integer that specifies the number of mappings between OLAP measure groups and **OLAP dimensions (1)** in the OLAP measure group collection. Each mapping is defined by an [SXAddl_SXCSXMgs_SXDMGrpSXDHMap](#) record. This value MUST be equal to the number of [SXAddl_SXCSXMgs_SXDMGrpSXDHMap](#) records that follow this record.

2.4.273.96 SXAddl_SXCSXMgs_SXDMGrpSXDHMap

The **SXAddl_SXCSXMgs_SXDMGrpSXDHMap** record specifies a mapping between an **OLAP measure group** and an **OLAP dimension (1)** for an [SxcSXMgs class](#).

0	1	2	3	4	5	6	7	8	9	10	11	12	13	14	15	16	17	18	19	20	21	22	23	24	25	26	27	28	29	30	31
hdr																															
...															reserved1																
...															reserved2																
iKey																															
iVal																															

hdr (6 bytes): An [SXAddlHdr](#) structure. The value of **hdr.sxc** MUST equal 0x13 and the value of **hdr.sxd** MUST equal 0x23.

reserved1 (4 bytes): MUST be zero, and MUST be ignored.

reserved2 (2 bytes): MUST be zero, and MUST be ignored.

iKey (4 bytes): An unsigned integer that specifies a zero-based index of an [SXCSXMg class](#) in the collection of SXCSXMg classes. The [SXAddl_SXCSXMg_SXDId](#) record of the referenced SXCSXMg class specifies an OLAP measure group in the **measure group** collection. MUST be less than the value of the **cmgs** field of the [SXAddl_SXCSXMgs_SXDId](#) record of this SxcSXMgs class.

iVal (4 bytes): An unsigned integer that specifies a zero-based index of the [SXAddl_SXCSXDH_SXDSxdh](#) record in the collection of SXAddl_SXCSXDH_SXDSxdh records in the [SXCSXDH class](#) of the containing [SxcCache class](#) of this record. The referenced record specifies an OLAP dimension (1). MUST be less than the value of the **dwCount** field of the [SXAddl_SXCSXDH_SXDIId](#) record of the SXCSXDH class.

2.4.273.97 SXAddl_SXCSXrule_SXDEnd

The **SXAddl_SXCSXrule_SXDEnd** record specifies the end of an [SXCSXrule class](#).

0	1	2	3	4	5	6	7	8	9	10	11	12	13	14	15	16	17	18	19	20	21	22	23	24	25	26	27	28	29	30	31
hdr																															
...															reserved																
...																															

hdr (6 bytes): An [SXAddlHdr](#) structure. The value of **hdr.sxc** MUST equal 0x0C and the value of **hdr.sxd** MUST equal 0xFF.

reserved (6 bytes): MUST be zero, and MUST be ignored.

2.4.273.98 SXAddl_SXCSXrule_SXDIId

The **SXAddl_SXCSXrule_SXDIId** record specifies information for a [PivotTable rule](#), for the [SXCSXrule class](#).

0	1	2	3	4	5	6	7	8	9	10	11	12	13	14	15	16	17	18	19	20	21	22	23	24	25	26	27	28	29	30	31
hdr																															
...															reserved																
...																															

hdr (6 bytes): An [SXAddlHdr](#) structure. The value of **hdr.sxc** MUST equal 0x0C and the value of **hdr.sxd** MUST equal 0x00.

reserved (6 bytes): MUST be zero, and MUST be ignored.

2.4.273.99 SXAddl_SXCSXrule_SXDSXrule

The **SXAddl_SXCSXrule_SXDSXrule** record specifies information for a [PivotTable rule](#), for an [SXCSXrule class](#).

0	1	2	3	4	5	6	7	8	9	10	11	12	13	14	15	16	17	18	19	20	21	22	23	24	25	26	27	28	29	30	31
hdr																															

...										reserved1										
...																				
A		sxrtype		B	C	D	E	F	G	H	I	J	reserved4							
K	L	M	N	O	P	reserved6						irwFirst				irwLast				
icolFirst					icolLast					csxfilt										
...										iDim										
...										isxvd										
...																				

hdr (6 bytes): An [SXAddlHdr](#) structure. The value of **hdr.sxc** MUST equal 0x0C and the value of **hdr.sxd** MUST equal 0x13.

reserved1 (6 bytes): MUST be zero, and MUST be ignored.

A - reserved2 (4 bits): MUST be zero, and MUST be ignored.

sxrtype (4 bits): An unsigned integer that specifies the area of the [PivotTable](#) specified by this PivotTable rule. MUST be a value from the following table:

Value	Meaning
0x0	This rule applies to no area.
0x1	This rule applies to selected cells in the row area , column area , or data area of the PivotTable report.
0x2	This rule applies to the data area of the PivotTable report.
0x3	This rule applies to the entire PivotTable report.
0x4	This rule applies to the blank cells at the logical top-left of the PivotTable report.
0x5	This rule applies to a button shown next to a pivot field in the PivotTable report.
0x6	This rule applies to the blank cells at the logical top-right of the PivotTable report.

If the value of **isxvd** is not -1, MUST be 0x1 or 0x2 or 0x5.

B - fPart (1 bit): A bit that specifies whether only a portion of the [PivotTable area](#) is included in this rule. MUST be a value from the following table:

Value	Meaning
0x0	The entire PivotTable area is included in the rule. The irwFirst , irwLast , icolFirst , and icolLast fields are undefined and MUST be ignored.
0x1	A portion of the PivotTable area is included in the rule. The irwFirst , irwLast , icolFirst , and icolLast fields hold the relative offset into the PivotTable area included in this rule.

- C - fDataOnly (1 bit):** A bit that specifies whether only the cells in the data area are included in this PivotTable rule. If **fLabelOnly** is 1 then **fDataOnly** MUST be 0. If **sxrtype** is 0x2, the value of this field value MUST be 1.
 - D - fLabelOnly (1 bit):** A bit that specifies whether only cells in the [page area](#), row area, or column area are included in this PivotTable rule. If **fDataOnly** is 1 then **fLabelOnly** MUST be 0. If **sxrtype** is 0x5 or 0x6, this value MUST be 1.
 - E - fGrandRw (1 bit):** A bit that specifies whether cells in the **grand total** row are included in this PivotTable rule.
 - F - fGrandCol (1 bit):** A bit that specifies whether cells in the grand total column are included in this PivotTable rule.
 - G - fGrandRwSav (1 bit):** A bit that specifies whether cells in the grand total row are included in this PivotTable rule. MUST be equal to **fGrandRw**.
 - H - reserved3 (1 bit):** MUST be zero, and MUST be ignored.
 - I - fGrandColSav (1 bit):** A bit that specifies whether cells in the grand total column are included in this PivotTable rule. MUST be equal to **fGrandCol**.
 - J - fFuzzy (1 bit):** A bit that specifies whether the [pivot items](#) of the pivot field specified by this rule are treated as subtotals for the purposes of formatting when the pivot field is displayed in outline mode.
- reserved4 (15 bits):** MUST be zero, and MUST be ignored.
- K - unused1 (1 bit):** Undefined, MUST be ignored.
 - L - fLineMode (1 bit):** A bit that specifies whether the area of the PivotTable report specified by this PivotTable rule is displayed in outline mode.
 - M - unused2 (1 bit):** Undefined, MUST be ignored.
 - N - unused3 (1 bit):** Undefined, MUST be ignored.
 - O - reserved5 (1 bit):** MUST be zero, and MUST be ignored.
 - P - fDrillOnly (1 bit):** A bit that specifies the **sort order** of the PivotTable rule filters specified by **csxfilt**. MUST be a value from the following table:

Value	Meaning
0x0	PivotTable rule filters are sorted by Pivot Field index as specified in Pivot Fields.
0x1	PivotTable rule filters are sorted by position.

- reserved6 (10 bits):** MUST be zero, and MUST be ignored.
- irwFirst (1 byte):** A [DRwByteU](#) structure that specifies the difference between the index of the first row of the range of cells included in this rule and the index of the first row of the PivotTable.
- irwLast (1 byte):** A [DRwByteU](#) structure that specifies the difference between the index of the last row of the range of cells included in this rule and the index of the first row of the PivotTable. If **fPart** is 1, MUST be greater than or equal to **irwFirst**.

icolFirst (1 byte): A [DColByteU](#) structure that specifies the difference between the index of the first column of the range of cells included in this rule and the index of the first column of the PivotTable.

icolLast (1 byte): A [DColByteU](#) structure that specifies the difference between the index of the last column of the range of cells included in this rule and the index of the first column of the PivotTable. If **fPart** is 1, **icolLast** MUST be greater than or equal to **icolFirst**.

csxfilt (4 bytes): An unsigned integer that specifies the number of [SXAddl_SXCSXfilt_SXDId](#) records following this record. MUST be greater than or equal to 0. If **sxrtype** is not 0x1 or 0x2, this value MUST be 0.

iDim (4 bytes): An signed integer that specifies the position of the pivot field within the [PivotTable axis](#) for this PivotTable rule. If **isxvd** is 0xFFFFFFFF or 0xFFFFFFFF this field MUST be ignored. If **isxvd** is between 0x00000000 and 0x000000FF, then the value of **iDim** depends on the value of certain fields in the **sxaxis** structure in **isxvd**. The following table shows the values that **iDim** MUST have given certain values of the specified fields of **isxvd.sxaxis**.

Value	Meaning
isxvd.sxaxis.sxaxisRw is 1	The value of iDim MUST be greater than 0 and less than the number of pivot fields on the row axis .
isxvd.sxaxis.sxaxisCol is 1	The value of iDim MUST be greater than 0 and less than the number of pivot fields on the column axis .
isxvd.sxaxis.sxaxisPage is 1	The value of iDim MUST be greater than 0 and less than the number of pivot fields on the page axis .
isxvd.sxaxis.sxaxisData is 1	The value of iDim MUST be greater than 0 and less than the number of pivot fields on the data axis .

isxvd (4 bytes): A signed integer that specifies the pivot field this rule refers to. MUST be a value from the following table:

Value	Meaning
0xFFFFFFFFE	This rule refers to the data field .
0xFFFFFFFF	This rule does not refer to a pivot field.
0x00000000 to 0x000000FF	This value specifies a pivot field index as specified in Pivot Fields. The pivot field index specifies which pivot field this rule refers to.

MUST be greater than or equal to 0xFFFFFFFFE and less than or equal to 0x000000FF. If the value is greater than or equal to 0x00000000, MUST be less than the value of the **cDim** field of the preceding [SxView](#).

2.4.273.100 SXAddl_SXCView_SXDCalcMember

The **SXAddl_SXCView_SXDCalcMember** record specifies [OLAP calculated members](#) properties for a [PivotTable view](#), for an [SxcView class](#).

0	1	2	3	4	5	6	7	8	9	10	11	12	13	14	15	16	17	18	19	20	21	22	23	24	25	26	27	28	29	30	31
hdr																															
...																A	B	C	D	E			F	reserved2							

...	reserved3
stName (variable)	
...	
stMDXFormula (variable)	
...	
stMemberName (variable)	
...	
stSourceHierarchy (variable)	
...	
stParentUnique (variable)	
...	
wSolveOrder	

hdr (6 bytes): An [SXAddlHdr](#) structure. The value of **hdr.sxc** MUST equal 0x00 and the value of **hdr.sxd** MUST equal 0x03.

A - fParentUnique (1 bit): A bit that specifies whether **stParentUnique** exists. If the value is 1, **stParentUnique** exists. If **fSet** is 1, this field MUST be zero.

B - fMemberName (1 bit): A bit that specifies whether **stMemberName** exists. If the value is 1, **stMemberName** exists. If **fSet** is 1, this field MUST be zero; otherwise, this field MUST be 1.

C - fSourceHier (1 bit): A bit that specifies whether **stSourceHierarchy** exists. If the value is 1, **stSourceHierarchy** exists. If **fSet** is 1, this field MUST be zero; otherwise, this field MUST be 1.

D - fLongFormula (1 bit): A bit that specifies whether the length of the user-specified **MDX expression** that defines the calculation is greater than 255 characters.

MUST be a value from the following table:

Value	Meaning
0	Length of the user-specified MDX expression is less than or equal to 255 characters and stMDXFormula contains the MDX.
1	Length of the user-specified MDX expression is greater than 255 characters and the user-specified MDX expression is written to a subsequent SXAddl , SXCView , or SXDCalcMemString record.

E - reserved1 (4 bits): MUST be zero, and MUST be ignored.

F - fSet (1 bit): A bit that specifies whether this calculation is for an **OLAP named set**.

reserved2 (23 bits): MUST be zero, and MUST be ignored.

reserved3 (2 bytes): MUST be zero, and MUST be ignored.

stName (variable): An [XLUnicodeString](#) structure that specifies the **MDX unique name** of this OLAP calculated member. The length of this field MUST be greater than 0 characters and less than or equal to 255 characters.

stMDXFormula (variable): An [XLUnicodeString](#) structure that specifies the user-specified MDX expression for this OLAP calculated member. If **fLongFormula** is 1, this field does not exist. If **fLongFormula** is 0, the length of this field MUST be greater than 0 characters and less than or equal to 255 characters.

stMemberName (variable): An [XLUnicodeString](#) structure that specifies the name of this OLAP calculated member. If **fMemberName** is 0, this field does not exist. If **fMemberName** is 1, the length of this field MUST be less than or equal to 255 characters.

stSourceHierarchy (variable): An [XLUnicodeString](#) structure that specifies the MDX unique name of the **OLAP hierarchy** that this OLAP calculated member is associated with. If **fSourceHier** is zero this field does not exist. If **fSourceHier** is 1 then the length of this field MUST be less than or equal to 255 characters.

stParentUnique (variable): An [XLUnicodeString](#) structure that specifies the MDX unique name of the parent **member (2)** that this OLAP calculated member is associated with. If **fParentUnique** is zero this field does not exist. If **fParentUnique** is 1 then the length of this field MUST be less than or equal to 255 characters.

wSolveOrder (4 bytes): An unsigned integer that specifies the calculation order when there are multiple OLAP calculated members. The calculation order goes from lowest **wSolveOrder** value to highest. If the value is zero the calculation order is determined by the **OLAP data provider**.

2.4.273.101 SXAddI_SXCView_SXDCalcMemString

The **SXAddI_SXCView_SXDCalcMemString** record specifies a user-specified **MDX expression** for an [OLAP calculated member](#), for an [SxcView class](#). The other properties of the OLAP calculated member are specified in the preceding [SXAddI_SXCView_SXDCalcMember](#) record.

0	1	2	3	4	5	6	7	8	9	10	11	12	13	14	15	16	17	18	19	20	21	22	23	24	25	26	27	28	29	30	31
hdr																															
...																stMDXFormula (variable)															
...																															

hdr (6 bytes): An [SXAddIHdr](#) structure. The value of **hdr.sxc** MUST equal 0x00 and the value of **hdr.sxd** MUST equal 0x0A.

stMDXFormula (variable): An [SXAddI_SXString](#) structure that specifies the user-specified MDX expression. The length of this field MUST be greater than zero. If the [PivotCache functionality level](#) of the [associated PivotCache](#) of this [PivotTable view](#) is less than 3, the length of this field MUST be less than 2048 characters; otherwise, the length MUST be less than 32767 characters.

2.4.273.102 SXAddI_SXCView_SXDCompactColHdr

The **SXAddI_SXCView_SXDCompactColHdr** record specifies the [column area](#) caption string used in the compact [PivotTable layout](#) for a [PivotTable view](#), for an [SxcView class](#).

0	1	2	3	4	5	6	7	8	9	10	11	12	13	14	15	16	17	18	19	20	21	22	23	24	25	26	27	28	29	30	31
hdr																															
...																stHeader (variable)															
...																															

hdr (6 bytes): An [SXAddlHdr](#) structure. The value of **hdr.sxc** MUST equal 0x00 and the value of **hdr.sxd** MUST equal 0x22.

stHeader (variable): An [SXAddl_SXString](#) structure that specifies the caption displayed in the column area of the compact PivotTable layout. The length MUST be less than or equal to 255 characters.

2.4.273.103 SXAddl_SXCView_SXDCompactRwHdr

The **SXAddl_SXCView_SXDCompactRwHdr** record specifies the [row area](#) caption string used in the compact [PivotTable layout](#) for a [PivotTable view](#), for an [SxcView class](#).

0	1	2	3	4	5	6	7	8	9	10	11	12	13	14	15	16	17	18	19	20	21	22	23	24	25	26	27	28	29	30	31
hdr																															
...																stHeader (variable)															
...																															

hdr (6 bytes): An [SXAddlHdr](#) structure. The value of **hdr.sxc** MUST equal 0x00 and the value of **hdr.sxd** MUST equal 0x21.

stHeader (variable): An [SXAddl_SXString](#) structure that specifies the caption displayed in the row area of the compact PivotTable layout. The length MUST be less than or equal to 255 characters.

2.4.273.104 SXAddl_SXCView_SXDEnd

The **SXAddl_SXCView_SXDEnd** record specifies the end of an [SxcView class](#).

0	1	2	3	4	5	6	7	8	9	10	11	12	13	14	15	16	17	18	19	20	21	22	23	24	25	26	27	28	29	30	31
hdr																															
...																reserved															
...																															

hdr (6 bytes): An [SXAddlHdr](#) structure. The value of **hdr.sxc** MUST equal 0x00 and the value of **hdr.sxd** MUST equal 0xFF.

reserved (6 bytes): MUST be zero, and MUST be ignored.

2.4.273.105 SXAddI_SXCView_SXDIId

The **SXAddI_SXCView_SXDIId** record specifies how an [SxcView class](#) is associated with other records for a [PivotTable view](#).

0	1	2	3	4	5	6	7	8	9	10	11	12	13	14	15	16	17	18	19	20	21	22	23	24	25	26	27	28	29	30	31
hdr																															
...																stName (variable)															
...																															

hdr (6 bytes): An [SXAddIHdr](#) structure. The value of **hdr.sxc** MUST equal 0x00 and the value of **hdr.sxd** MUST equal 0x00.

stName (variable): An [SXAddI_SXString](#) structure that specifies the PivotTable view that this SxcView class applies to. The corresponding [SxView](#) record of this PivotTable view is the SxView record, in this [Worksheet substream](#), with its **stTable** field equal to the value of this field. If there exists no such SxView record then this SxcView class MUST be ignored.

2.4.273.106 SXAddI_SXCView_SXDSXPIIvmb

The **SXAddI_SXCView_SXDSXPIIvmb** record specifies a mapping between [value metadata](#) and a field on the [page axis](#) for a [PivotTable view](#), for an [SxcView class](#).

0	1	2	3	4	5	6	7	8	9	10	11	12	13	14	15	16	17	18	19	20	21	22	23	24	25	26	27	28	29	30	31
hdr																															
...																reserved															
...																															
isxpi																															
ivmb																															

hdr (6 bytes): An [SXAddIHdr](#) structure. The value of **hdr.sxc** MUST equal 0x00 and the value of **hdr.sxd** MUST equal 0x36.

reserved (6 bytes): MUST be zero, and MUST be ignored.

isxpi (4 bytes): An unsigned integer that specifies the index of the entry on the page axis. MUST be greater than or equal to zero and less than the value of the **cDimPg** field of the [SxView](#) record of the PivotTable view.

ivmb (4 bytes): An unsigned integer that specifies the zero-based index of the [MDB](#) record in the sequence of records that conforms to the [MDBLOCK](#) rule. The referenced MDB specifies the value metadata. MUST be greater than or equal to zero and less than the count of MDB records.

2.4.273.107 SXAddl_SXCView_SXDTableStyleClient

The **SXAddl_SXCView_SXDTableStyleClient** record specifies [table style](#) properties for a [PivotTable view](#), for an [SxcView class](#).

0	1	2	3	4	5	6	7	8	9	10	11	12	13	14	15	16	17	18	19	20	21	22	23	24	25	26	27	28	29	30	31				
hdr																																			
...																reserved1																			
...																																			
A	B	C	D	E	F	G	reserved2														stName (variable)														
...																																			

hdr (6 bytes): An [SXAddlHdr](#) structure. The value of **hdr.sxc** MUST equal 0x00 and the value of **hdr.sxd** MUST equal 0x1E.

reserved1 (6 bytes): MUST be zero, and MUST be ignored.

A - unused (1 bit): Undefined and MUST be ignored.

B - fLastColumn (1 bit): A bit that specifies whether any [table style elements](#) (as specified by [TableStyleElement](#)) with a **tseType** field equal to 0x00000004 are applied to the PivotTable view.

C - fRowStrips (1 bit): A bit that specifies whether any table style elements (as specified by [TableStyleElement](#)) with a **tseType** field equal to 0x00000005 or 0x00000006 are applied to the PivotTable view.

D - fColumnStrips (1 bit): A bit that specifies whether any table style elements (as specified by [TableStyleElement](#)) with a **tseType** field equal to 0x00000007 or 0x00000008 are applied to the PivotTable view.

E - fRowHeaders (1 bit): A bit that specifies whether any table style elements (as specified by [TableStyleElement](#)) with a **tseType** field equal to 0x00000003, 0x00000017, 0x00000018, or 0x00000019 are applied to the PivotTable view.

F - fColumnHeaders (1 bit): A bit that specifies whether any table style elements (as specified by [TableStyleElement](#)) with a **tseType** field equal to 0x00000001, 0x00000014, 0x00000015, or 0x00000016 are applied to the PivotTable view.

G - fDefaultStyle (1 bit): A bit that specifies whether to apply the default [TableStyle](#) to the PivotTable view.

reserved2 (9 bits): MUST be zero, and MUST be ignored.

stName (variable): An [LPWideString](#) structure that specifies the name of the TableStyle applied to the PivotTable view. The length MUST be greater than zero and less than or equal to 255 characters.

2.4.273.108 SXAddl_SXCView_SXDVer10Info

The **SXAddl_SXCView_SXDVer10Info** record specifies information about a [PivotTable view](#) for an [SxcView class](#).

0	1	2	3	4	5	6	7	8	9	10	11	12	13	14	15	16	17	18	19	20	21	22	23	24	25	26	27	28	29	30	31
hdr																															
...																bVerSxMacro						A	B	C	D	E	F	G	H		
I	J					unused											reserved2														

hdr (6 bytes): An [SXAddIHdr](#) structure. The value of **hdr.sxc** MUST equal 0x00 and the value of **hdr.sxd** MUST equal 0x02.

bVerSxMacro (1 byte): A [DataFunctionalityLevel](#) structure that specifies the [data functionality level](#) that this [PivotTable](#) was created with. SHOULD [<129>](#) be less than 3 if the [PivotCache functionality level](#) of the [associated PivotCache](#) is less than 3. MUST be greater than or equal to 3 if the [PivotCache functionality level](#) of the associated [PivotCache](#) is greater than or equal to 3.

A - fDisplayImmediateItems (1 bit): A bit that specifies whether [pivot items](#) are displayed in the [PivotTable](#) view even when there is no [pivot field](#) on the [data axis](#). If **bVerSxMacro** is greater than or equal to 3 then this value MUST be 1.

B - fEnableDataEd (1 bit): A bit that specifies whether the user is allowed to change values in the data axis of the [PivotTable](#) view.

C - fDisableFList (1 bit): A bit that specifies whether the **PivotTable field list** is disabled.

D - fReenterOnLoadOnce (1 bit): A bit that specifies whether the [PivotTable](#) view is recalculated the next time the **workbook** is opened.

E - fNotViewCalculatedMembers (1 bit): A bit that specifies whether **OLAP calculated members** are **hidden** in the [PivotTable](#) view.

MUST be a value from the following table:

Value	Meaning
0	OLAP calculated members are not hidden.
1	OLAP calculated members are hidden.

MUST be ignored if the [PivotTable](#) view is a non-[OLAP PivotTable view](#).

F - fNotVisualTotals (1 bit): A bit that specifies whether **grand totals** and subtotals in an [OLAP PivotTable](#) view include the values of hidden **OLAP members**.

MUST be a value from the following table:

Value	Meaning
0	Hidden OLAP members are not included in grand totals and subtotals.
1	Hidden OLAP members are included in grand totals and subtotals.

MUST be ignored if the [PivotTable](#) view is a non-[OLAP PivotTable](#) view.

G - fPageMultipleItemLabel (1 bit): A bit that specifies what text is displayed in a **cell** in the page area when a non-**OLAP data source** has one or more hidden pivot items.

MUST be a value from the following table:

Value	Meaning
-------	---------

Value	Meaning
0	Show text indicating that all items are displayed.
1	If the data source has one or more hidden pivot items, show text indicating that not all items are displayed, otherwise show text indicating that all items are displayed.

MUST be ignored if the PivotTable view is an OLAP PivotTable view.

H - fTensorFillColor (1 bit): A bit that specifies whether the **fill color** retrieved from the OLAP data source is used in the PivotTable view.

MUST be a value from the following table:

Value	Meaning
0	The fill color from the OLAP data source is not used.
1	If the data source is OLAP and the fill color is available from the OLAP data source, then the fill color is used.

MUST be ignored if the PivotTable view is a non-OLAP PivotTable view.

I - fHideDDDData (1 bit): A bit that specifies whether the control for selecting the pivot items to be displayed in the PivotTable view is hidden.

J - reserved1 (3 bits): MUST be zero, and MUST be ignored.

unused (12 bits): Undefined, and MUST be ignored.

reserved2 (2 bytes): MUST be zero, and MUST be ignored.

2.4.273.109 SXAddI_SXCView_SXDVer12Info

The **SXAddI_SXCView_SXDVer12Info** record specifies information for a [PivotTable view](#), for an [SxcView class](#).

0	1	2	3	4	5	6	7	8	9	10	11	12	13	14	15	16	17	18	19	20	21	22	23	24	25	26	27	28	29	30	31													
hdr																																												
...																								A	B	C	D	E	F	G	H	I	J	K	reserved2									
...				L	M	N	O	cIndentInc				P	reserved3																															

hdr (6 bytes): An [SXAddIHdr](#) structure. The value of **hdr.sxc** MUST equal 0x00 and the value of **hdr.sxd** MUST equal 0x19.

A - fDefaultCompact (1 bit): A bit that specifies whether new [pivot fields](#) added to the PivotTable view are in **compact axis** mode by default.

B - fDefaultOutline (1 bit): A bit that specifies whether new pivot fields added to the PivotTable view are displayed in outline format by default.

C - fOutlineData (1 bit): A bit that specifies whether the [data field](#) is displayed in outline format. See [Subtotalling](#) for more information.

D - fCompactData (1 bit): A bit that specifies whether the data field is displayed in compact axis mode. See [PivotTable Layout](#) for more information.

E - fNewDropZones (1 bit): A bit that specifies whether the application allows dragging within the **PivotTable field list**.

F - fPublished (1 bit): A bit that specifies whether this PivotTable is marked as having already been **published** to a server-based application. This bit is ignored if the **fPublishedBookItems** field of the [BookExt_Conditional12](#) structure is zero.

G - fTurnOffImmersive (1 bit): A bit that specifies whether a user interface for manipulating PivotTable options is displayed.

MUST be a value from the following table:

Value	Meaning
0	A user interface for manipulating PivotTable options is displayed.
1	A user interface for manipulating PivotTable options is not displayed.

H - fSingleFilterPerField (1 bit): A bit that specifies whether this PivotTable can have multiple **filters** per field.

MUST be a value from the following table:

Value	Meaning
0	The PivotTable can have many filters per field.
1	The PivotTable can have a maximum of one filter per field.

I - fNonDefaultSortInFlist (1 bit): A bit that specifies whether PivotTable fields are sorted in the PivotTable field list.

MUST be a value from the following table:

Value	Meaning
0	PivotTable fields are not sorted in the PivotTable field list.
1	PivotTable fields are sorted in the PivotTable field list.

J - reserved1 (1 bit): MUST be zero, and MUST be ignored.

K - fDontUseCustomLists (1 bit): A bit that specifies whether to use **custom lists** when sorting the PivotTable.

MUST be a value from the following table:

Value	Meaning
0	Custom lists are used when sorting the PivotTable.
1	Custom lists are not used when sorting the PivotTable.

reserved2 (9 bits): MUST be zero, and MUST be ignored.

L - fHideDrillIndicators (1 bit): A bit that specifies whether the **expand/collapse buttons** are **hidden** in the PivotTable view.

M - fPrintDrillIndicators (1 bit): A bit that specifies whether the expand/collapse buttons are printed.

N - fMemPropsInTips (1 bit): A bit that specifies whether **OLAP member** properties are displayed in **ToolTips**.

O - fNoPivotTips (1 bit): A bit that specifies whether ToolTips are displayed on cells in the PivotTable view.

MUST be a value from the following table:

Value	Meaning
0	ToolTips are displayed on cells in the PivotTable view.
1	ToolTips are not displayed on cells in the PivotTable view.

cIndentInc (7 bits): An unsigned integer that specifies the number of characters to indent row labels by when compact axis mode is used. See PivotTable Layout for more information.

P - fNoHeaders (1 bit): A bit that specifies whether field captions are displayed in the PivotTable layout.

MUST be a value from the following table:

Value	Meaning
0	Field captions are displayed in the PivotTable layout.
1	Field captions are not displayed in the PivotTable layout.

reserved3 (2 bytes): MUST be zero, and MUST be ignored.

2.4.273.110 SXAddI_SXCView_SXDVerUpdInv

The **SXAddI_SXCView_SXDVerUpdInv** record specifies the record-handling behavior for following records of the [SXCView class](#).

0	1	2	3	4	5	6	7	8	9	10	11	12	13	14	15	16	17	18	19	20	21	22	23	24	25	26	27	28	29	30	31
data																															
...																															
...																															

data (12 bytes): An [SXAddI_SXDVerUpdInv](#) structure. The value of **data.hdr.sxc** MUST equal 0x00 and the value of **data.hdr.sxd** MUST equal 0x01. The value of **data.dwVersionInvalidates** MUST equal 0x0002 or 0x00FF.

If the value of **data.dwVersionInvalidates** is not 0x00FF and is greater than or equal to the value of the **VerSxLastUpdated** field of the [OsiSXTag](#) record of this [PivotTable view](#), the following records of this SXCView class, including nested classes or until another SXAddI_SXCView_SXDVerUpdInv record is encountered, MUST be ignored.

2.4.274 SxBool

The **SxBool** record specifies a Boolean [cache item](#) or value.

0	1	2	3	4	5	6	7	8	9	10	11	12	13	14	15	16	17	18	19	20	21	22	23	24	25	26	27	28	29	30	31
bool																															

bool (2 bytes): A Boolean (section [2.5.14](#)) that specifies the record value.

2.4.275 SXDB

The **SXDB** record specifies [PivotCache](#) properties.

0	1	2	3	4	5	6	7	8	9	10	11	12	13	14	15	16	17	18	19	20	21	22	23	24	25	26	27	28	29	30	31						
crdbdb																																					
idstm																A	B	C	D	E	F	unused1															
unused2																cfbdb																					
cfdbTot																crdbUsed																					
vsType																cchWho																					
rgb (variable)																																					
...																																					

crdbdb (4 bytes): A signed integer that specifies the number of [cache records](#) for this PivotCache. MUST be greater than or equal to 0. MUST be 0 for [OLAP PivotCaches](#). MUST be ignored if **fSaveData** is 0.

idstm (2 bytes): An unsigned integer that specifies the stream that contains the data for this PivotCache. MUST be equal to the value of the **idstm** field of the [SXStreamID](#) record that specifies the PivotCache stream that contains this record.

A - fSaveData (1 bit): A bit that specifies whether cache records exist. MUST be 0 for OLAP PivotCaches.

B - fInvalid (1 bit): A bit that specifies whether the cache records are in the not-valid state. MUST be equal to 1 if the [PivotCache functionality level](#) is greater than or equal to 3. MUST be equal to 1 for OLAP PivotCaches. See cache records for more information.

C - fRefreshOnLoad (1 bit): A bit that specifies whether the PivotCache is refreshed on load.

D - fOptimizeCache (1 bit): A bit that specifies whether optimization is applied to the PivotCache to reduce memory usage. MUST be 0 and MUST be ignored for a non-**ODBC** PivotCache.

E - fBackgroundQuery (1 bit): A bit that specifies whether the **query** used to **refresh** the PivotCache is executed asynchronously. MUST be ignored if **vsType** not equals 0x0002.

F - fEnableRefresh (1 bit): A bit that specifies whether refresh of the PivotCache is enabled. MUST be equal to 0 if the PivotCache functionality level is greater than or equal to 3. MUST be equal to 0 for OLAP PivotCaches.

unused1 (10 bits): Undefined and MUST be ignored.

unused2 (2 bytes): Undefined and MUST be ignored.

cfdbdb (2 bytes): A signed integer that specifies the number of [cache fields](#) that corresponds to the [source data](#). MUST be greater than or equal to 0.

cfdbTot (2 bytes): A signed integer that specifies the number of cache fields in the PivotCache. MUST be greater than or equal to 0.

crdbUsed (2 bytes): An unsigned integer that specifies the number of records used to calculate the [PivotTable](#) report. Records excluded by [PivotTable view](#) filtering are not included in this value. MUST be 0 for OLAP PivotCaches.

vsType (2 bytes): An unsigned integer that specifies the type of source data. MUST be equal to the value of the **svs** field of the [SXVS](#) record that follows the SXStreamID record that specifies the PivotCache stream that contains this record.

cchWho (2 bytes): An unsigned integer that specifies the number of characters in **rgb**. MUST be equal to 0xFFFF, or MUST be greater than or equal to 1 and less than or equal to 0x00FF.

rgb (variable): An optional [XLUnicodeStringNoCch](#) structure that specifies the name of the user who last refreshed the PivotCache. MUST exist if and only if the value of **cchWho** is not equal to 0xFFFF. If this field exists, the length MUST equal **cchWho**. The length of this value MUST be less than 256 characters. The name is an application-specific setting that is not necessarily related to the [User Names Stream ABNF](#).

2.4.276 SXDBB

The **SXDBB** record specifies the values of all the [cache fields](#) that have a **fAllAtoms** field of the [SXFDB](#) record equal to 1 and that correspond to [source data](#) entities, as specified by cache fields, for a single [cache record](#).

0	1	2	3	4	5	6	7	8	9	10	1	2	3	4	5	6	7	8	9	20	1	2	3	4	5	6	7	8	9	30	1		
blob (variable)																																	
...																																	

blob (variable): An array of 1-byte and 2-byte unsigned integers that specifies indexes to [cache items](#) of cache fields that correspond to source data entities, as specified by cache fields, that have an **fAllAtoms** field of the SXFDB record equal to 1. The order of the indexes specified in the array corresponds to the order of the cache fields as they appear in the [PivotCache](#). Each unsigned integer specifies a zero-based index of a record in the sequence of records that conforms to the [SRCSXOPER](#) rule of the associated cache field. The referenced record from the SRCSXOPER rule specifies a cache item that specifies a value for the associated cache field. If the **fShortItems** field of an SXFDB record of the cache field equals 1, the index value for this cache field is stored in this field in two bytes; otherwise, the index value is stored in this field in a single byte.

2.4.277 SXDBEx

The **SXDBEx** record specifies additional [PivotCache](#) properties.

0	1	2	3	4	5	6	7	8	9	10	11	12	13	14	15	16	17	18	19	20	21	22	23	24	25	26	27	28	29	30	31
numDate																															
...																															
cSxFormula																															

numDate (8 bytes): A [DateAsNum](#) structure that specifies the date and time on which the PivotCache was created or last refreshed.

cSxFormula (4 bytes): An unsigned integer that specifies the count of [SXFormula](#) records for this cache.

2.4.278 SXDI

The **SXDI** record specifies a [data item](#) for a [PivotTable view](#).

0	1	2	3	4	5	6	7	8	9	10	11	12	13	14	15	16	17	18	19	20	21	22	23	24	25	26	27	28	29	30	31
isxvdData																iiftab															
df																isxvd															
isxvi																ifmt															
cchName																stName (variable)															
...																															

isxvdData (2 bytes): A signed integer that specifies a [pivot field](#) index as specified in Pivot Fields.

If the PivotTable view is a non-[OLAP PivotTable view](#), the values in the [source data](#) associated with the associated [cache field](#) of the referenced pivot field are aggregated as specified in this record.

If the PivotTable view is an OLAP PivotTable view, the associated [pivot hierarchy](#) of the referenced pivot field specifies the **OLAP measure** for this data item and the **iiftab** field is ignored. See [Association of Pivot Hierarchies and Pivot Fields and Cache Fields](#) to determine the associated pivot hierarchy.

MUST be greater than or equal to zero and less than the value of the **cDim** field of the preceding [SxView](#) record.

The value of the **sxaxis.sxaxisData** field of the [Sxvd](#) record of the referenced pivot field MUST be 1.

iiftab (2 bytes): A signed integer that specifies the **aggregation function**.

MUST be a value from the following table:

Value	Meaning
0x0000	Sum of values
0x0001	Count of values

Value	Meaning
0x0002	Average of values
0x0003	Max of values
0x0004	Min of values
0x0005	Product of values
0x0006	Count of numbers
0x0007	Statistical standard deviation (sample)
0x0008	Statistical standard deviation (population)
0x0009	Statistical variance (sample)
0x000A	Statistical variance (population)

df (2 bytes): A signed integer that specifies the calculation used to display the value of this data item.

MUST be a value from the following table:

Value	Meaning
0x0000	The data item value is displayed.
0x0001	Display as the difference between this data item value and the value of the pivot item specified by isxvi .
0x0002	Display as a percentage of the value of the pivot item specified by isxvi .
0x0003	Display as a percentage difference from the value of the pivot item specified by isxvi .
0x0004	Display as the running total for successive pivot items in the pivot field specified by isxvd .
0x0005	Display as a percentage of the total for the row containing this data item.
0x0006	Display as a percentage of the total for the column containing this data item.
0x0007	Display as a percentage of the grand total of the data item.
0x0008	Calculate the value to display using the following formula: $\frac{((\text{this data item value}) * (\text{grand total of grand totals}))}{((\text{row grand total}) * (\text{column grand total}))}$

isxvd (2 bytes): A signed integer that specifies a pivot field index as specified in Pivot Fields. The referenced pivot field is used in calculations as specified by the **df** field.

If **df** is 0x0001, 0x0002, 0x0003, or 0x0004 then the value of **isxvd** MUST be greater than or equal to zero and less than the value of the **cDim** field in the preceding SxView record. Otherwise, the value of **isxvd** is undefined and MUST be ignored.

isxvi (2 bytes): A signed integer that specifies the pivot item used by **df**.

If **df** is 0x0001, 0x0002, or 0x0003 then the value of this field MUST be a value from the following table:

Value	Meaning
0 to 0x7EFE	A pivot item index, as specified by Pivot Items, that specifies a pivot item in the pivot field specified by isxvd . MUST be less than the cDim field of the Sxvd record of the pivot field specified by isxvd .
0x7FFB	The previous pivot item in the pivot field specified by isxvd .
0x7FFC	The next pivot item in the pivot field specified by isxvd .

Otherwise, the value is undefined and MUST be ignored.

ifmt (2 bytes): An [IFmt](#) structure that specifies the **number format** for this item.

cchName (2 bytes): An unsigned integer that specifies the length, in characters, of the [XLUnicodeStringNoCch](#) structure in the **stName** field. If the value is 0xFFFF then **stName** does not exist. Otherwise, the value MUST be greater than zero and less than or equal to 0x00FF.

MUST NOT be 0xFFFF when the [PivotCache functionality level](#) is less than 3, or for non-OLAP PivotTable view .

stName (variable): An XLUnicodeStringNoCch structure that specifies the name of this data item. A value that is not NULL specifies that this string is used to override the name in the corresponding cache field.

MUST NOT exist if **cchName** is 0xFFFF. Otherwise, MUST exist and the length MUST equal **cchName**.

If this string is not NULL and the PivotTable view is a non-OLAP PivotTable view, this field MUST be unique within all SXDI records in this PivotTable view.

2.4.279 SXDtr

The **SXDtr** record specifies a [cache item](#) or a value in the [PivotCache](#) that is an instance in time, expressed as a date and time of day.

0	1	2	3	4	5	6	7	8	9	10	11	12	13	14	15	16	17	18	19	20	1	2	3	4	5	6	7	8	9	30	1
yr															mon																
dom					hr					min					sec																

yr (2 bytes): An unsigned integer that specifies the year component of the date. MUST be greater than or equal to 1900 and MUST be less than or equal to 9999. If **dom** is 0, **yr** MUST be 1900.

mon (2 bytes): An unsigned integer that specifies the month component of the date. MUST be greater than or equal to 1, and MUST be less than or equal to 12. If **dom** is equal to 0, **mon** MUST be equal to 1.

dom (1 byte): An unsigned integer that specifies the day of month component of the date. MUST be greater than or equal to 0 and MUST be less than or equal to 31.

hr (1 byte): An unsigned integer that specifies the hour component of the time of day. MUST be less than or equal to 23.

min (1 byte): An unsigned integer that specifies the minute component of the time of day. MUST be less than or equal to 59.

sec (1 byte): An unsigned integer that specifies the second component of the time of day. MUST be less than or equal to 59.

2.4.280 SxDXF

The **SxDXF** record specifies [differential formatting](#) applied to a [PivotTable area](#).

0	1	2	3	4	5	6	7	8	9	10	11	12	13	14	15	16	17	18	19	20	21	22	23	24	25	26	27	28	29	30	31
dxfl (variable)																															
...																															

dxfl (variable): A [DXFN12NoCB](#) structure that specifies the differential formatting.

2.4.281 SxErr

The **SxErr** record specifies an error [cache item](#) or value.

0	1	2	3	4	5	6	7	8	9	10	11	12	13	14	15	16	17	18	19	20	21	22	23	24	25	26	27	28	29	30	31
wbe																															

wbe (2 bytes): An unsigned integer that specifies the error record value. MUST be a value from the following table [<130>](#):

Value	Meaning
0x00	#NULL!
0x07	#DIV/0!
0x0F	#VALUE!
0x17	#REF!
0x1D	#NAME?
0x24	#NUM!
0x2A	#N/A

2.4.282 SXEx

The **SXEx** record specifies additional properties of a [PivotTable view](#) and specifies the beginning of a collection of records as defined by the [Worksheet substream ABNF](#). The collection of records specifies **selection** and formatting properties for the PivotTable view.

0	1	2	3	4	5	6	7	8	9	10	11	12	13	14	15	16	17	18	19	20	21	22	23	24	25	26	27	28	29	30	31
csxformat																cchErrorString															
cchNullString																cchTag															
csxselect																crwPage															
ccolPage																A	cWrapPage						B	C	reserved2						
D	E	F	G	H	I	J	K	reserved3								cchPageFieldStyle															
cchTableStyle																cchVacateStyle															

stError (variable)
...
stDisplayNull (variable)
...
stTag (variable)
...
stPageFieldStyle (variable)
...
stTableStyle (variable)
...
stVacateStyle (variable)
...

csxformat (2 bytes): An unsigned integer that specifies the number of [SxFormat](#) records that follow this record. MUST be less than or equal to 0xFFFF.

cchErrorString (2 bytes): An unsigned integer that specifies the length, in characters, of the [XLUnicodeStringNoCch](#) structure in the **stError** field. If the value is 0xFFFF, then **stError** does not exist. MUST be 0xFFFF or MUST be greater than zero and less than or equal to 0x00FF.

cchNullString (2 bytes): An unsigned integer that specifies the length, in characters, of the [XLUnicodeStringNoCch](#) structure in the **stDisplayNull** field. If the value is 0xFFFF, then **stDisplayNull** does not exist. MUST be 0xFFFF or MUST be greater than zero and less than or equal to 0x00FF.

cchTag (2 bytes): An unsigned integer that specifies the length, in characters, of the [XLUnicodeStringNoCch](#) structure in the **stTag** field. If the value is 0xFFFF, then **stTag** does not exist. MUST be 0xFFFF or MUST be greater than zero and less than or equal to 0x00FF.

csxselect (2 bytes): An unsigned integer that specifies the number of [SxSelect](#) records that follow this record. MUST be less than or equal to 0xFFFF.

crwPage (2 bytes): A [DRw](#) structure that specifies the number of rows in the page area (see [Location and Body](#)) of the PivotTable view.

ccolPage (2 bytes): A [DCol](#) structure that specifies the number of columns in the page area (see [Location and Body](#)) of the PivotTable view.

A - fAcrossPageLay (1 bit): A bit that specifies how [pivot fields](#) are laid out in the page area (see [Location and Body](#)) when there are multiple pivot fields on the [page axis](#). MUST be a value from the following table:

Value	Meaning
0x0	Pivot fields are displayed in the page area from the top to the bottom first, as fields are added, before moving to another column.
0x1	Pivot fields are displayed in the page area from left to right first, as fields are added, before moving to another row.

cWrapPage (8 bits): An unsigned integer that specifies the number of pivot fields in the page area (see Location and Body) to display before moving to another row or column, as specified by **fAcrossPageLay**.

MUST be less than or equal to 0xFF. A value of 0 means that no wrap is allowed.

B - unused (1 bit): Undefined and MUST be ignored.

C - reserved1 (1 bit): MUST be zero and MUST be ignored.

reserved2 (5 bits): MUST be zero and MUST be ignored.

D - fEnableWizard (1 bit): A bit that specifies whether a wizard user interface is displayed to work with the PivotTable view.

E - fEnableDrilldown (1 bit): A bit that specifies whether details can be shown for **cells** in the data area, as specified by [PivotTable Layout](#).

F - fEnableFieldDialog (1 bit): A bit that specifies whether a user interface for setting properties of a pivot field can be displayed.

G - fPreserveFormatting (1 bit): A bit that specifies whether formatting is preserved when the PivotTable view is recalculated.

If the value is 1, **csxformat** MUST be 0 and there MUST be no SxFormat records following this record.

H - fMergeLabels (1 bit): A bit that specifies whether empty cells adjacent to the cells displaying [pivot item](#) captions of pivot fields on the [row axis](#) and [column axis](#) of the PivotTable view are merged into a single cell with center-aligned text.

I - fDisplayErrorString (1 bit): A bit that specifies whether the PivotTable view displays the custom error string **stError** in cells that contain errors.

J - fDisplayNullString (1 bit): A bit that specifies whether the PivotTable view displays the custom string **stDisplayNull** in cells that contain NULL values.

K - fSubtotalHiddenPageItems (1 bit): A bit that specifies whether hidden pivot items, as specified by [SXVI](#) records with the **fHidden** field equal to 1, of a pivot field on the page axis with the **isxvi** field of the corresponding [SXPI Item](#) structure equal to 0x7FFD are filtered out when calculating the PivotTable view.

MUST be 0 for non-**OLAP data sources** if the [PivotCache functionality level](#) is 3.

reserved3 (8 bits): MUST be zero and MUST be ignored.

cchPageFieldStyle (2 bytes): An unsigned integer that specifies the length, in characters, of the XLUnicodeStringNoCch structure in the **stPageFieldStyle** field. If the value is 0xFFFF, then **stPageFieldStyle** does not exist.

MUST be 0xFFFF or MUST be greater than zero and less than or equal to 0x00FF.

cchTableStyle (2 bytes): An unsigned integer that specifies the length, in characters, of the XLUnicodeStringNoCch structure in the **stTableStyle** field. If the value is 0xFFFF, then **stTableStyle** does not exist.

MUST be 0xFFFF or MUST be greater than zero and less than or equal to 0x00FF.

cchVacateStyle (2 bytes): An unsigned integer that specifies the length, in characters, of the XLUnicodeStringNoCch structure in the **stVacateStyle** field. If the value is 0xFFFF, then **stVacateStyle** does not exist.

MUST be 0xFFFF or MUST be greater than zero and less than or equal to 0x00FF.

stError (variable): An XLUnicodeStringNoCch structure that specifies a custom string displayed in cells that contain errors when the value of **fDisplayErrorString** is 1. The length is specified in **cchErrorString**.

This field is optional and MUST NOT exist if **cchErrorString** is 0xFFFF.

stDisplayNull (variable): An XLUnicodeStringNoCch structure that specifies a custom string displayed in cells that contain NULL values when **fDisplayNullString** is 1. The length is specified in **cchNullString**.

This field is optional and MUST NOT exist if **cchNullString** is 0xFFFF.

stTag (variable): An XLUnicodeStringNoCch structure that specifies a custom string saved with the PivotTable view. The length is specified in **cchTag**.

This field is optional and MUST NOT exist if **cchTag** is 0xFFFF.

stPageFieldStyle (variable): An XLUnicodeStringNoCch structure that specifies the **style** used in the page area (see Location and Body) of the PivotTable view. The style is specified by the [StyleExt](#) record with its **stName** field equal to this field's value. If **cchPageFieldStyle** is 0xFFFF or less than 1, no style is applied. The length is specified in **cchPageFieldStyle**.

This field is optional and MUST NOT exist if **cchPageFieldStyle** is 0xFFFF.

stTableStyle (variable): An XLUnicodeStringNoCch structure that specifies the style used in the body of the PivotTable view. The style is specified by the StyleExt record with its **stName** field equal to this field's value. If **cchTableStyle** is 0xFFFF or less than 1, no style is applied. The length is specified in **cchTableStyle**.

This field is optional and MUST NOT exist if **cchTableStyle** is 0xFFFF.

stVacateStyle (variable): An XLUnicodeStringNoCch structure that specifies the style applied to cells that become empty when the PivotTable view is recalculated. The style is specified by the StyleExt record with its **stName** field equal to this field's value. If **cchVacateStyle** is 0xFFFF or less than 1, no style is applied. The length is specified in **cchVacateStyle**.

This field is optional and MUST NOT exist if **cchVacateStyle** is 0xFFFF.

2.4.283 SXFDB

The **SXFDB** record specifies properties for a [cache field](#) within a [PivotCache](#).

0	1	2	3	4	5	6	7	8	9	10	11	12	13	14	15	16	17	18	19	20	21	22	23	24	25	26	27	28	29	30	31
A	B	C	D	E	F	G	H	I	J	K	L	M	N	O	P	ifdbParent															

ifdbBase	citmUnq
csxoper	cisxoper
catm	stFieldName (variable)
...	

- A - fAllAtoms (1 bit):** A bit that specifies whether this cache field has a collection of [cache items](#). If **fSomeUnhashed** is equal to 1, this value MUST be equal to 0.
- B - fSomeUnhashed (1 bit):** Undefined, and MUST be ignored. If the **fAllAtoms** field is equal to 1, MUST be equal to 0.
- C - fUsed (1 bit):** Undefined, and MUST be ignored.
- D - fHasParent (1 bit):** A bit that specifies whether **ifdbParent** specifies a reference to a parent grouping cache field. For more information, see [Grouping](#). If the **fCalculatedField** field is equal to 1, then this field MUST be equal to 0.
- E - fRangeGroup (1 bit):** A bit that specifies whether this cache field is grouped by using numeric grouping or date grouping, as specified by [Grouping](#). If this field is equal to 1, then this record MUST be followed by a sequence of [SXString](#) records, as specified by the [GRPSXOPER](#) rule. The quantity of SXString records is specified by **csxoper**. If this field is equal to 1, then this record MUST be followed by a sequence of records that conforms to the SXRANGE rule that specifies the grouping properties for the ranges of values.
- F - fNumField (1 bit):** A bit that specifies whether the cache items in this cache field contain at least one numeric cache item, as specified by [SXNum](#). If **fDateInField** is equal to 1, this field MUST be equal to 0.
- G - unused1 (1 bit):** Undefined and MUST be ignored.
- H - fTextEtcField (1 bit):** A bit that specifies whether the cache items contain text data. If **fNumField** is 1, this field MUST be ignored.
- I - fnumMinMaxValid (1 bit):** A bit that specifies whether a valid minimum or maximum value can be computed for the cache field. MUST be equal to 1 if **fDateInField** or **fNumField** is equal to 1.
- J - fShortIitms (1 bit):** A bit that specifies whether there are more than 255 cache items in this cache field. If **catm** is greater than 255, this value MUST be equal to 1; otherwise it MUST be 0.
- K - fNonDates (1 bit):** A bit that specifies whether the cache items in this cache field contain values that are not time or date values. If this cache field is a grouping cache field, as specified by [Grouping](#), then this field MUST be ignored. Otherwise, if **fDateInField** is equal to 1, then this field MUST be 0.
- L - fDateInField (1 bit):** A bit that specifies whether the cache items in this cache field contain at least one time or date cache item, as specified by [SXDtr](#). If **fNonDates** is equal to 1, then this field MUST be equal to 0.
- M - unused2 (1 bit):** Undefined and MUST be ignored.
- N - fServerBased (1 bit):** A bit that specifies whether this cache field is a server-based page field when the corresponding [pivot field](#) is on the [page axis](#) of the [PivotTable view](#), as specified in [source data](#).

This value applies only to an **ODBC** PivotCache. MUST NOT be equal to 1 if **fCantGetUniqueItems** is equal to 1. If **fCantGetUniqueItems** is equal to 1, then the [ODBC connection](#) cannot provide a list of unique items for the cache field.

MUST be 0 for a cache field in a non-ODBC PivotCache.

O - fCantGetUniqueItems (1 bit): A bit that specifies whether a list of unique values for the cache field was not available while refreshing the source data. This field applies only to a PivotCache that uses ODBC source data and is intended to be used in conjunction with optimization features. For example, the application can optimize memory usage when populating PivotCache records if it has a list of unique values for a cache field before all the records are retrieved from the ODBC connection. Or, the application can determine the appropriate setting of **fServerBased** based on this value.

MUST be 0 for fields in a non-ODBC PivotCache.

P - fCalculatedField (1 bit): A bit that specifies whether this field is a [calculated field](#). The formula (section [2.2.2](#)) of the calculated field is stored in a directly following [SXFormula](#) record. If **fHasParent** is equal to 1, this field MUST be equal to 0.

ifdbParent (2 bytes): An unsigned integer that specifies the cache field index, as specified by Cache Fields, of the grouping cache field for this cache field. MUST be greater than or equal to 0x0000 and less than the **cfdbTot** field of the [SXDB](#) record of this PivotCache. If **fHasParent** is equal to 0, then this field MUST be ignored. If **fHasParent** is equal to 1, and **fRangeGroup** is equal to 1, and the **iByType** field of the [SXRng](#) record of this cache field is greater than 0, then the **fRangeGroup** of the SXFDB record of the cache field specified by **ifdbParent** MUST be 1 and the **iByType** field of the SXRng record of the cache field specified by **ifdbParent** MUST be greater than the **iByType** field of the SXRng record of this cache field.

ifdbBase (2 bytes): An unsigned integer that specifies the cache field index, as specified by Cache Fields, of the base cache field, as specified by Grouping, for the cache field specified by this record. MUST be greater than or equal to 0x0000 and less than the value of the **cfdbdb** field of the SXDB record of this PivotCache. If the cache field specified by this record is not a grouping cache field, then this field MUST be ignored.

citmUnq (2 bytes): Undefined and MUST be ignored.

csxoper (2 bytes): An unsigned integer that specifies the number of cache items in this cache field when this cache field is a grouping cache field, as specified by Grouping. There MUST be an equivalent number of sequences of records that conform to the GRPSXOPER rule following this record that specify the cache items. If the **fRangeGroup** field and the **fCalculatedField** field are equal to 0 and this cache field corresponds to a source data entity, this field MUST be equal to 0. If the **fRangeGroup** field is equal to 1, this value MUST be greater than or equal to 1.

cisxoper (2 bytes): An unsigned integer that specifies the number of cache items in the base cache field that are grouped by this cache field. There MUST be an equivalent number of [SxIsxoper](#) records following this record that specify which cache item in this cache field groups each of the cache items in the base cache field. For more information, see Grouping.

catm (2 bytes): An unsigned integer that specifies the number of cache items in the collection sequences of records that conform to the SRCSXOPER rule in this cache field. If **fAllAtoms** is 0, then this field MUST be equal to 0x0000. If this cache field corresponds to source data entities then there MUST be an equal number of SRCSXOPER rules in this cache field.

stFieldName (variable): An [XLUnicodeString](#) structure that specifies the name of the cache field. MUST be less than or equal to 255 characters long.

2.4.284 SXFDBType

The **SXFDBType** record specifies the type of data contained in this [cache field](#).

0	1	2	3	4	5	6	7	8	9	10	11	12	13	14	15	16	17	18	19	20	21	22	23	24	25	26	27	28	29	30	31
wTypeSql																															

wTypeSql (2 bytes): An [ODBCType](#) structure that specifies the **ODBC** data type as returned by the ODBC provider of the data in this cache field.

2.4.285 SxFilt

The **SxFilt** record specifies information for a [PivotTable rule](#) filter.

See [SxRule](#) for more information about [PivotTable views](#) that this record applies to.

0	1	2	3	4	5	6	7	8	9	10	11	12	13	14	15	16	17	18	19	20	21	22	23	24	25	26	27	28	29	30	31
A	B	C	D	E	iDim										isxvd										F	G	H				
grbitSbt																cisxvi															

A - sxaxisRw (1 bit): A bit that specifies whether this **filter** refers to the [row axis](#). MUST be zero if **sxaxisCol** is 1, if **sxaxisPage** is 1, or if **sxaxisData** is 1.

B - sxaxisCol (1 bit): A bit that specifies whether this filter refers to the [column axis](#). MUST be zero if **sxaxisRw** is 1, if **sxaxisPage** is 1, or if **sxaxisData** is 1.

C - sxaxisPage (1 bit): A bit that specifies whether this filter refers to the [page axis](#). MUST be zero if **sxaxisRw** is 1, if **sxaxisCol** is 1, or if **sxaxisData** is 1.

D - sxaxisData (1 bit): A bit that specifies whether this filter refers to the [value axis](#). MUST be zero if **sxaxisRw** is 1, if **sxaxisCol** is 1, or if **sxaxisPage** is 1.

E - reserved1 (2 bits): MUST be zero, and MUST be ignored.

iDim (10 bits): A signed integer that specifies the zero-based position of the [PivotTable field](#) within the [PivotTable axis](#) specified by **sxAxis**. MUST be greater than or equal to 0 and less than or equal to 31.

isxvd (10 bits): A signed integer that specifies the [data field](#), pivot field, or [cache field](#) that this filter refers to. MUST be greater than or equal to 0 and less than or equal to 255 or equal to -2. MUST be a value from the following table:

Value	Value of the fCacheBased field of the preceding SxRule record	Meaning
-2	MUST be 0	Specifies that this rule refers to the data field.
A value greater than or equal to zero	0	Specifies a pivot field index as specified by pivot fields. The pivot field index specifies which pivot field is referenced by this filter.

Value	Value of the fCacheBased field of the preceding SxRule record	Meaning
A value greater than or equal to zero	1	Specifies a cache field index as specified by cache fields. The cache field index specifies which cache field is referenced by this filter.

F - fSelected (1 bit): A bit that specifies whether the header of the PivotTable field this filter refers to is included in the PivotTable rule that this record belongs to.

G - reserved2 (1 bit): MUST be zero, and MUST be ignored.

H - reserved3 (4 bits): MUST be zero, and MUST be ignored.

grbitSbt (2 bytes): A signed integer that specifies the set of subtotals used in this filter. MUST be one of the following bits, or a combination of the following bits. DEFAULT MUST be combined only with DATA, BLANK, or both.

Bits	Meaning
0x0001	DATA
0x0002	DEFAULT
0x0004	SUM
0x0008	COUNTA
0x0010	AVERAGE
0x0020	MAX
0x0040	MIN
0x0080	PRODUCT
0x0100	COUNT
0x0200	STDEV
0x0400	STDEVP
0x0800	VAR
0x1000	VARP
0x4000	BLANK

cisxvi (2 bytes): An unsigned integer that specifies the number of indexes in the [SxItm](#) record that follows this record.

2.4.286 SxFmla

The **SxFmla** record specifies a [PivotParsedFormula](#) and specifies the beginning of a collection of records as defined by the [pivot cache](#) storage **ABNF**. The collection of records specifies the [PivotTable calculated field](#) or [calculated item](#) formula (section [2.2.2](#)).

0	1	2	3	4	5	6	7	8	9	10	11	12	13	14	15	16	17	18	19	20	21	22	23	24	25	26	27	28	29	30	31
formula (variable)																															

...

formula (variable): A PivotParsedFormula structure that specifies the formula.

2.4.287 SxFormat

The **SxFormat** record specifies the beginning of a collection of records as defined by the [Worksheet substream ABNF](#). The collection of records specifies the [differential formatting](#) and specifies a [PivotRule](#) that specifies the area of the [PivotTable view](#) to apply the formatting to.

0	1	2	3	4	5	6	7	8	9	10	11	12	13	14	15	16	17	18	19	20	1	2	3	4	5	6	7	8	9	30	1
rIType										reserved										cbData											

rIType (4 bits): A Boolean (section [2.5.14](#)) that specifies whether formatting was applied to the PivotTable view. MUST be a value from the following table:

Value	Description
0x0000	The formatting was cleared.
0x0001	The formatting was applied.

reserved (12 bits): MUST be zero, and MUST be ignored

cbData (2 bytes): An unsigned integer that specifies the number of bytes in the [SxDXF](#) record that follows this record. MUST be zero if **rIType** is zero. If this field is zero then zero [SxDXF](#) records MUST follow this record.

2.4.288 SXFormula

The **SXFormula** record specifies the [cache field](#) that a [calculated item](#) formula (section [2.2.2](#)) applies to. The calculated item formula is stored in the last [SxFmla](#) record preceding this record.

0	1	2	3	4	5	6	7	8	9	10	11	12	13	14	15	16	17	18	19	20	1	2	3	4	5	6	7	8	9	30	1
reserved																ifdb															

reserved (2 bytes): MUST be zero, and MUST be ignored.

ifdb (2 bytes): A signed integer that specifies the cache field index as specified in Cache Fields. The cache field index specifies which cache field the calculated item formula applies to. MUST be greater than or equal to -1. If the value is -1, the calculated item formula applies to all cache fields. If the cache field is a source field, the value MUST be equal to the value of **isxvd** in the last [SxRule](#) record preceding this record.

2.4.289 SXInt

The **SXInt** record specifies a number in the [PivotCache](#).

0	1	2	3	4	5	6	7	8	9	10	11	12	13	14	15	16	17	18	19	20	21	22	23	24	25	26	27	28	29	30	31
num																															

num (2 bytes): A signed integer that specifies a number in the PivotCache.

2.4.290 SxIsxoper

The **SxIsxoper** record specifies the mapping between [cache items](#) in a [cache field](#) and cache items in a grouping cache field for discrete grouping, as specified by [Grouping](#). The grouping cache field is specified by the [SXFDB](#) record preceding this record. The value of the **fRangeGroup** field of the SXFDB record MUST be 0 and the value of the **csxoper** field of the SXFDB record MUST be greater than 0. This record immediately follows the collection of records that specifies cache item values for the SXFDB record as defined in the [PivotCache Storage](#) part **ABNF**.

0	1	2	3	4	5	6	7	8	9	10	11	12	13	14	15	16	17	18	19	20	21	22	23	24	25	26	27	28	29	30	31
rgSxIsxoper (variable)																															
...																															

rgSxIsxoper (variable): An array of 2-byte unsigned integers. Each element of the array corresponds to a cache item in the cache field being grouped by the grouping cache field. The value of each element specifies the index of the cache item, as specified by Cache Items, in the grouping cache field that the cache item in the cache field is grouped under.

The count of elements in the array MUST be equal to the value of the **csxoper** field of the SXFDB record preceding this record and is identical to the number of cache items in the cache field being grouped. The value of each element MUST be less than the total number of cache items in the grouping cache field.

2.4.291 SxItm

The **SxItm** record specifies references to [pivot items](#), [data items](#), or [cache items](#) as part of a [PivotTable rule](#) filter.

If this record exists, the **cisxvi** field of the preceding [SxFilt](#) MUST be greater than 0.

See [SxRule](#) for more information about [PivotTable views](#) that this record applies to.

0	1	2	3	4	5	6	7	8	9	10	11	12	13	14	15	16	17	18	19	20	21	22	23	24	25	26	27	28	29	30	31
rgisxvi (variable)																															
...																															

rgisxvi (variable): An array of 2-byte unsigned integers that specifies pivot items, data item, or cache items associated with **ranges of cells** included in the PivotTable rule. The array MUST be sorted in ascending order. The size of the array MUST be equal to the value of the **cisxvi** field of the preceding SxFilt record. Each unsigned 2-byte integer in the array MUST be less than or equal to 32500, or equal to 32767. The value 32767 specifies that there is no associated pivot item,

data item, or cache item with the index. For more information, see PivotTable Rules. The meaning of this field is specified in the following table:

Value of the isxvd field of the preceding SxFilt record	Value of the fCacheBased field of the preceding SxRule record	Meaning of the index
-2	Not used	A data item index that specifies a data item associated with ranges of cells included in the PivotTable rules. MUST be less than the value of the cDimData field of the associated SxView record.
>= 0	0	A pivot item index that specifies a pivot item in the pivot field specified by the isxvd field of the SxFilt record. The referenced pivot item is associated with ranges of cells included in the PivotTable rule. MUST be less than the cItems field of the Sxvd record.
	1	A cache item index, as specified by cache items, within the cache field specified by the isxvd field of the SxFilt record in the current PivotCache . The referenced cache item is associated with ranges of cells included in the PivotTable rule. MUST be less than the total number of cache items within the cache field associated with the pivot field specified by the isxvd field of the SxFilt record.

2.4.292 SxIvd

The **SxIvd** record specifies an array of [SxIvdRw](#) or [SxIvdCol](#).

An array of SxIvdRw specifies all items for the [row axis](#) of the [PivotTable view](#). An array of SxIvdCol specifies all items on [column axis](#) of the PivotTable view.

Two or fewer records of this type appear in the file depending on the values of the **cDimRw** and **cDimCol** fields of the [SxView](#) record of the PivotTable view.

If the **cDimRw** and **cDimCol** fields of the SxView record are both greater than zero, then two records of this type appear in the file for the PivotTable view. The first record is an array of SxIvdRw and the second record is an array of SxIvdCol.

If the value of the **cDimRw** field of the SxView record is greater than zero and the value of the **cDimCol** field of the SxView record is equal to zero, then only one record of this type appears in the file for the PivotTable view and it is an array of SxIvdRw.

If the value of the **cDimCol** field of the SxView record is greater than zero and the value of the **cDimRw** field of the SxView record is equal to zero, then only one record of this type appears in the file for the PivotTable view and it is an array of SxIvdCol.

0	1	2	3	4	5	6	7	8	9	10	1	2	3	4	5	6	7	8	9	20	1	2	3	4	5	6	7	8	9	30	1		
rgSxIvd (variable)																																	
...																																	

rgSxIvd (variable): An array of SxIvdRw or SxIvdCol items.

If this is an array of SxIvdRw, the count of elements in the array MUST equal the value of the **cDimRw** field of the SxView record.

If this is an array of SxIvdCol, the count of elements in the array MUST equal the value of the **cDimCol** field of the SxView record.

2.4.293 SXLI

The **SXLI** record specifies [pivot lines](#) for the [row area](#) or [column area](#) of a [PivotTable view](#).

0	1	2	3	4	5	6	7	8	9	10	1	2	3	4	5	6	7	8	9	20	1	2	3	4	5	6	7	8	9	30	1		
rgsqli (variable)																																	
...																																	

rgsqli (variable): An array of [SXLIItem](#).

Zero or two records of this type appear in the file for each PivotTable view depending on the values of the **cRw** and **cCol** fields of the associated [SxView](#) record.

If the value of either of the **cRw** or **cCol** fields of the associated SxView is greater than zero, then two records of this type MUST exist in the file for the associated SxView. The first record contains row area pivot lines and the second record contains column area pivot lines.

The count of SXLIItem structures in **rgsqli**, which are row area pivot lines, MUST equal the **cRw** field of SxView.

The count of SXLIItem structures in **rgsqli**, which are column area pivot lines, MUST equal the **cCol** field of SxView.

The associated SxView record is the SxView record of the PivotTable view.

2.4.294 SxName

The **SxName** record specifies information used for a [calculated field](#) or [calculated item](#) and that specifies the beginning of a collection of records as specified by the [pivot cache](#) storage **ABNF**. When used for a calculated field, this record specifies the index of a [cache field](#) used in a calculated field formula (section [2.2.2](#)). When used for a calculated item, this record is followed by a collection of [SxPair](#) records that specify a [pivot item](#) used in a calculated item formula (section [2.2.2](#)).

0	1	2	3	4	5	6	7	8	9	10	1	2	3	4	5	6	7	8	9	20	1	2	3	4	5	6	7	8	9	30	1
A	B	unused2														ifdb															
ifn														csxpair																	

A - unused1 (1 bit): Undefined and MUST be ignored.

B - fErrName (1 bit): A bit that specifies whether this record is not valid. MUST be set to 1 if **ifdb** field is set to -1.

unused2 (14 bits): Undefined and MUST be ignored.

ifdb (2 bytes): A signed integer that specifies a cache field index. The cache field index specifies a cache field used in a calculated field formula. MUST be greater than or equal to -1. MUST be set to

-1 if **csxpair** is greater than 0. MUST be set to -1 when the calculated field formula cannot be computed because the cache field used in the formula is removed.

ifn (2 bytes): A signed integer that MUST be set to -1.

csxpair (2 bytes): An unsigned integer that specifies the count of contiguous SXPair records that follow this record. MUST be less than or equal to 1. MUST be equal to 0 if and only if this record is in a calculated field.

2.4.295 SxNil

The **SxNil** record specifies an empty [cache item](#) or value.

2.4.296 SXNum

The **SXNum** record specifies a numeric [cache item](#) or value.

0	1	2	3	4	5	6	7	8	9	10	11	12	13	14	15	16	17	18	19	20	21	22	23	24	25	26	27	28	29	30	31
num																															
...																															

num (8 bytes): An Xnum (section [2.5.342](#)) structure that specifies the numeric record value.

2.4.297 SXPair

The **SXPair** record specifies a reference to a [pivot item](#) used to compute the value of a [calculated item](#) in a PivotTable.

0	1	2	3	4	5	6	7	8	9	10	11	12	13	14	15	16	17	18	19	20	21	22	23	24	25	26	27	28	29	30	31				
isxvd																iCache																			
reserved1																A	B	C	D	reserved3															

isxvd (2 bytes): An unsigned integer that specifies a [cache field](#) index. This index specifies a cache field that contains the [cache item](#) associated with the pivot item specified by **iCache**.

iCache (2 bytes): A signed integer that specifies a pivot item of the [PivotTable view](#) associated with this record as specified by [Associated PivotCache](#). This pivot item is used in a calculated item formula (section [2.2.2](#)). If more than one PivotTable view is associated with this record, **iCache** specifies a pivot item for each such PivotTable view.

If the value of **fPhysical** is 0, **iCache** is a cache item index and specifies the pivot item associated with that cache item.

Otherwise, if the value of **fRelative** is 0 or if no pivot item in the visible item collection has a pivot item index smaller than the pivot item index of the current pivot item, **iCache** is a visible item index. Otherwise, the pivot item specified by **iCache** is the pivot item whose visible item index equals the value of **iCache** + 1 + the largest visible item index whose associated pivot item has a pivot item index smaller than the pivot item index of the current pivot item. If this value is less than 0 or greater than or equal to the number of elements in the visible item collection, no pivot item is specified.

The current pivot item is the pivot item in the current [pivot field](#) that corresponds to the calculated item that contains this record.

The current pivot field is the pivot field of the PivotTable view associated with the cache field specified by **isxvd**.

The visible item collection is the ordered collection of all pivot items specified by the sequence of records that conforms to the [PIVOTVD](#) rule associated with the current pivot field that satisfy the following criteria:

- The value of the **fHidden** field of the [SXVI](#) record associated with the pivot item is 0.
- The value of the **fMissing** field of the SXVI record associated with the pivot item is 0 or the value of the **fShowAllItems** field of the SXVI record associated with the current pivot field is 1.
- The value of the **itmType** field of the SXVI record associated with the pivot item is 0.

A visible item index is specified to be the zero-based index of a pivot item in the visible item collection.

reserved1 (2 bytes): MUST be zero, and MUST be ignored.

A - fFormula (1 bit): A bit that specifies whether the item is a calculated item. If **fPhysical** is 1, it MUST have the same value as the **fFormula** field of the SXVI record corresponding to the pivot item specified by **iCache**.

B - reserved2 (2 bits): MUST be zero, and MUST be ignored.

C - fPhysical (1 bit): A bit that specifies whether **iCache** specifies a cache item index.

Value	Meaning
0	iCache specifies a cache item index.
1	iCache does not specify a cache item index.

D - fRelative (1 bit): A bit that specifies whether the item is referred to by relative position rather than absolute position. If **fPhysical** is 0, **fRelative** MUST be 0 and MUST be ignored. If **fPhysical** is 1, **fRelative** MUST be a value from the following table:

Value	Meaning
0	Absolute position.
1	Position relative to the calculated item referring this item.

reserved3 (11 bits): MUST be zero, and MUST be ignored.

2.4.298 SXPI

The **SXPI** record specifies the [pivot fields](#) and information about filtering on the [page axis](#) of a [PivotTable view](#).

MUST exist if and only if the value of the **cDimPg** field of the [SxView](#) record of the PivotTable view is greater than zero.

0	1	2	3	4	5	6	7	8	9	10	11	12	13	14	15	16	17	18	19	20	21	22	23	24	25	26	27	28	29	30	31
rgsxpi (variable)																															
...																															

rgsxpi (variable): An array of [SXPI Item](#)s that specifies the pivot fields and information about filtering on the page axis of a PivotTable view. The number of array elements MUST equal the value of the **cDimPg** field of the SxView record of the PivotTable view.

2.4.299 SXPIEx

The **SXPIEx** record specifies **OLAP** extensions to the [page axis](#) of a [PivotTable view](#). The number of SXPIEx records MUST equal the number of array elements in the **rgsxpi** field of the [SXPI](#) record. Each SXPIEx record corresponds to the [SXPI Item](#) at the same position in the **rgsxpi** field of the SXPI record.

For more information, see [OLAP Page Filtering](#).

0	1	2	3	4	5	6	7	8	9	10	11	12	13	14	15	16	17	18	19	20	21	22	23	24	25	26	27	28	29	30	31
frtHeaderOld																															
isxth																															
stUnique (variable)																															
...																															
stDisplay (variable)																															
...																															

frtHeaderOld (4 bytes): An [FrtHeaderOld](#) structure. The **frtHeaderOld.rt** field MUST be 0x080E.

isxth (4 bytes): An unsigned integer that specifies a [pivot hierarchy](#) index, as specified in Pivot Hierarchies, of the pivot hierarchy associated with this entry on the page axis. The **sxaxis.sxaxisPage** field of the [SXTH](#) record of the pivot hierarchy MUST be 1.

stUnique (variable): A [XLUnicodeString](#) structure that specifies the unique name of the **OLAP member** that is used for filtering. The length of the string MUST be less than or equal to 255.

stDisplay (variable): A [XLUnicodeString](#) structure that specifies the caption of this OLAP member. The length of the string MUST be less than or equal to 255.

2.4.300 SXRng

The **SXRng** record specifies properties for numeric grouping or date grouping of [cache items](#) in a grouping [cache field](#), as specified by [Grouping](#). The values of the **fRangeGroup** and **fCalculatedField** fields of the [SXFDB](#) record of this cache field MUST be 1 and 0, respectively.

0	1	2	3	4	5	6	7	8	9	10	11	12	13	14	15	16	17	18	19	20	21	22	23	24	25	26	27	28	29	30	31
A	B	C	unused																												

A - fAutoStart (1 bit): A bit that specifies whether the [source data](#) is used to set the starting range value.

Value	Meaning
0	The starting range value is not recalculated from the source data on the next refresh.
1	The starting range value is recalculated from the source data on the next refresh.

B - fAutoEnd (1 bit): A bit that specifies whether the source data is used to set the ending range value.

Value	Meaning
0	The ending range value is not recalculated from the source data on the next refresh.
1	The ending range value is recalculated from the source data on the next refresh.

C - iByType (3 bits): An unsigned integer that specifies the grouping criteria.

If the value of the **fNumField** field of the SXFDB record of this cache field is 1, **iByType** specifies numeric grouping, as specified by Grouping. In this case, **iByType** MUST be 0 and this record MUST be followed by three [SXNum](#) records specifying the starting number, the ending number, and the interval size, respectively. Additionally, the ending number MUST be greater than or equal to the starting number.

If the value of the **fNumField** field of the SXFDB record of this cache field is 0, **iByType** specifies date grouping, as specified by Grouping. In this case, **iByType** MUST be greater than 0. Additionally, this record MUST be followed by two [SXDtr](#) records followed by one [SXInt](#) record specifying the starting date/time, the ending date/time, and the interval size, respectively. The ending date/time MUST be greater than or equal to the starting date/time. If this cache field corresponds to source data entities, the collection of sequences of records that conform to the [SRCSXOPER](#) rule in this cache field MUST contain only [SXDtr](#) and [SxNil](#) records.

iByType MUST be a value from the following table:

Value	Meaning	Restriction on the value of the catm field of the SXFDB record of this cache field, dictated by the value of iByType .
0	Group by numeric value.	No restriction.
1	Group by seconds.	MUST be 62.

Value	Meaning	Restriction on the value of the catm field of the SXFDB record of this cache field, dictated by the value of iByType.
2	Group by minutes.	MUST be 62.
3	Group by hours.	MUST be 26.
4	Group by days.	MUST be 368.
5	Group by months.	MUST be 14.
6	Group by quarters.	MUST be 6.
7	Group by years.	No restriction.

unused (11 bits): Undefined and MUST be ignored.

2.4.301 SxRule

The **SxRule** record specifies areas or parts of a one or more [PivotTable views](#), as specified in [PivotTable rules](#), and that specifies the beginning of a collection of [SxFilt](#) records as specified by the [Common Productions ABNF](#). Each SxFilt record specifies an individual area or part of the PivotTable view.

If this record occurs as part of the specification of a PivotTable view, references (in this record and in the collection) to [pivot fields](#), the [data field](#), and [pivot items](#) are instances of those entities in the context of the PivotTable view.

If this record occurs as part of the specification of a [PivotCache](#), references (in this record and the collection) to PivotTable view, pivot fields, the data field, and pivot items are instances of those entities in the context of all the [associated PivotTable views](#) of the PivotCache.

0	1	2	3	4	5	6	7	8	9	10	11	12	13	14	15	16	17	18	19	20	21	22	23	24	25	26	27	28	29	30	31
iDim								isxvd								A	B	C	D	sxrType				E	F	G	H	I	J	K	L
reserved																csxFilt															
irwFirst (optional)								irwLast (optional)								icolFirst (optional)								icolLast (optional)							

iDim (8 bits): An unsigned integer that specifies the zero-based position of the pivot field specified by **isxvd** within the [PivotTable axis](#). MUST be greater than or equal to 0 and less than or equal to 255.

isxvd (8 bits): An unsigned integer that specifies the data field, pivot field, or [cache field](#) that this rule refers to. MUST be equal to 0xFF if this record is followed by any SxFilt records. MUST be a value from the following table:

Value	Value of fCacheBased	Meaning
0 to 0xFD	0	Specifies a pivot field index, as specified by pivot fields, to the pivot field that this rule refers to.
0 to 0xFD	1	Specifies a cache field index, as specified by cache fields, to the

Value	Value of fCacheBased	Meaning
		cache field that this rule refers to.
0xFE	MUST be 0	Specifies that this rule refers to the data field.
0xFF	0	Specifies that the rule is followed by zero or more SxFilt records, which specify the pivot fields that this rule refers to.
0xFF	1	Specifies that the rule is followed by zero or more SxFilt records, which specify the cache fields that this rule refers to.

A - sxaxisRw (1 bit): A bit that specifies whether the [row axis](#) is referenced by this record.

MUST be zero if **sxaxisCol** is 1, **sxaxisPage** is 1, or **sxaxisData** is 1.

B - sxaxisCol (1 bit): A bit that specifies whether the [column axis](#) is referenced by this record.

MUST be zero if **sxaxisRw** is 1, **sxaxisPage** is 1, or **sxaxisData** is 1.

C - sxaxisPage (1 bit): A bit that specifies whether the [page axis](#) is referenced by this record.

MUST be zero if **sxaxisRw** is 1, **sxaxisCol** is 1, or **sxaxisData** is 1.

D - sxaxisData (1 bit): A bit that specifies whether the [value axis](#) is referenced by this record.

MUST be zero if **sxaxisRw** is 1, **sxaxisCol** is 1, or **sxaxisPage** is 1.

sxrType (4 bits): An unsigned integer that specifies the PivotTable view area that this rule refers to. MUST be a value from the following table:

Value	Meaning
0x0	Does not refer to any area.
0x1	Refers to one or more pivot fields specified by SxFilt records that follow this record.
0x2	Refers to cells displaying values of data items specified by SxFilt records that follow this record.
0x3	Refers to the entire PivotTable view.
0x4	Refers to the cells at the top-left of the PivotTable view, or at the top-right for a right-to-left sheet . For more information about this area, see Location and Body .
0x5	Refers to a cell displaying a pivot field caption. The pivot field is specified by isxvd .
0x6	Refers to the cells at the top-right of the PivotTable view, or at the top-left for a right-to-left sheet. For more information about this area, see Location and Body .

This rule is followed by SxFilt records if and only if that value of **sxrType** is equal to 0x1 or 0x2.

E - fPart (1 bit): A bit that specifies whether only a portion of the PivotTable view area is included in this rule. If the value equals 1, **irwFirst**, **irwLast**, **icolFirst**, and **icolLast** hold the relative location in the PivotTable view area included in this rule.

F - fDataOnly (1 bit): A bit that specifies whether only the data cells of the PivotTable view are included in this rule. MUST be 0 if **fLabelOnly** is equal to 1.

G - fLabelOnly (1 bit): A bit that specifies whether only the labels of the PivotTable view are included in this rule. MUST be 1 if **sxrType** is equal to 0x5 or 0x6. MUST be 0 if **fDataOnly** is equal to 1.

H - fGrandRw (1 bit): A bit that specifies whether the grand total row is included in this rule.

I - fGrandCol (1 bit): A bit that specifies whether the grand total column is included in this rule.

J - fGrandRwSav (1 bit): A bit that specifies whether the grand total row was included in this PivotTable rule when the PivotTable rule was created.

K - fCacheBased (1 bit): A bit that specifies whether **isxvd** specifies a cache field in the PivotCache, or a pivot field or the data field in a PivotTable view.

Value	Meaning
0	isxvd specifies a pivot field or the data field in a PivotTable view.
1	isxvd specifies a cache field in the PivotCache.

L - fGrandColSav (1 bit): A bit that specifies whether the grand total column was included in this PivotTable rule when the PivotTable rule was created.

reserved (2 bytes): MUST be zero, and MUST be ignored.

csxFilt (2 bytes): An unsigned integer that specifies the number of SxFilt records following this record. MUST be zero if **sxrType** is neither 0x1 nor 0x2.

irwFirst (1 byte): An optional unsigned integer that specifies the offset of the first row, from the first cell in the PivotTable view area to the first cell in the partial area included in this rule. MUST be less than or equal to 255. This field MUST NOT exist if **fPart** is equal to 0.

irwLast (1 byte): An optional unsigned integer that specifies the offset of the last row, from the first cell in the PivotTable view area to the last cell in the partial area included in this rule. MUST be greater than or equal to **irwFirst** and less than or equal to 255. This field MUST NOT exist if **fPart** is equal to 0.

icolFirst (1 byte): An optional unsigned integer that specifies the offset of the first column, from the first cell in the PivotTable view area to the first cell in the partial area included in this rule. MUST be less than or equal to 255. This field MUST NOT exist if **fPart** is equal to 0.

icolLast (1 byte): An optional unsigned integer that specifies the offset of the last column, from the first cell in the PivotTable view area to the last cell in the partial area included in this rule. MUST be greater than or equal to **icolFirst** and less than or equal to 255. This field MUST NOT exist if **fPart** is equal to 0.

2.4.302 SxSelect

The **SxSelect** record specifies information about **selected cells** in the [PivotTable](#) report for a [PivotTable view](#). The selection is stored in the [PivotTable rule](#) following this record.

0	1	2	3	4	5	6	7	8	9	10	11	12	13	14	15	16	17	18	19	20	21	22	23	24	25	26	27	28	29	30	31
reserved1										pnn										reserved2											
sxaxisAct															iDimAct																
iLiStart															iLiAct																

iLiMin						iLiMax					
rwClick						colClick					
rwClickPrev						colClickPrev					
cClick	A	B	C	D	E	unused					

reserved1 (2 bytes): MUST be zero, and MUST be ignored.

pnn (1 byte): A [PaneType](#) structure that specifies the **active pane**.

reserved2 (1 byte): MUST be zero, and MUST be ignored.

sxaxisAct (2 bytes): An [SXAxis](#) structure that specifies the [PivotTable Axis selection](#).

The value of the **sxaxisData** field of SXAxis MUST be zero.

iDimAct (2 bytes): An unsigned integer that specifies the zero-based field position of the field that is selected within the PivotTable Axis.

iLiStart (2 bytes): An unsigned integer that specifies the zero-based position of the [PivotTable line](#) where the selection operation started. MUST be greater than or equal to the **iLiMin** field and less than or equal to the **iLiMax** field.

iLiAct (2 bytes): An unsigned integer that specifies the zero-based position of the PivotTable line that was most recently included in the selection. MUST be greater than or equal to zero and less than or equal to the **iLiMax** field.

iLiMin (2 bytes): An unsigned integer that specifies the zero-based position of the minimum PivotTable line that could be included in the selection. MUST be greater than or equal to zero and less than or equal to the **iLiMax** field.

iLiMax (2 bytes): An unsigned integer that specifies the zero-based position of the maximum PivotTable line that could be included in the selection. MUST be greater than or equal to zero. MUST be greater than or equal to the **iLiMin** field.

rwClick (2 bytes): An [RwU](#) structure that specifies the row of the cell where the user last clicked for the PivotTable selection.

colClick (2 bytes): A [ColU](#) structure that specifies the column of the cell where the user last clicked for the PivotTable selection.

rwClickPrev (2 bytes): An [RwU](#) structure that specifies the row of the cell previously clicked by the user on the PivotTable selection.

colClickPrev (2 bytes): A [ColU](#) structure that specifies the column of the cell previously clicked on the PivotTable selection.

cClick (5 bits): An unsigned integer that specifies the number of clicks made by the user to refine the current PivotTable selection.

A - fLabelOnly (1 bit): A bit that specifies that only cells in the [row area](#), [column area](#), or [page area](#) are selected.

B - fDataOnly (1 bit): A bit that specifies that only cells in the [data area](#) are selected.

C - fToggleDataHeader (1 bit): A bit that specifies whether the PivotTable selection toggle is enabled. The selection toggle enables a method for the user to select values, labels, or both values and labels.

D - fSelectionClick (1 bit): A bit that specifies whether any selections on the PivotTable were refined by the user.

E - fExtendable (1 bit): A bit that specifies whether an additional PivotTable line can be added to the current selection.

unused (6 bits): Undefined and MUST be ignored.

2.4.303 SXStreamID

The **SXStreamID** record specifies a stream in the [PivotCache storage](#).

0	1	2	3	4	5	6	7	8	9	10	11	12	13	14	15	16	17	18	19	20	21	22	23	24	25	26	27	28	29	30	31
idStm																															

idStm (2 bytes): An unsigned integer that specifies a stream in the PivotCache storage. The stream specified is the one that has its name equal to the hexadecimal representation of this field. The four-digit hexadecimal string representation of this field, where each hexadecimal letter digit is a capital letter, MUST be equal to the name of a stream in the PivotCache storage.

2.4.304 SXString

The **SXString** record specifies a segment of a string that contains information about a [PivotCache](#) or an [external connection](#). When this record occurs in a sequence of records that conforms to the [SRCSXOPER](#) rule or the [GRPSXOPER](#) rule, then it specifies a [cache item](#) with a string value.

0	1	2	3	4	5	6	7	8	9	10	11	12	13	14	15	16	17	18	19	20	21	22	23	24	25	26	27	28	29	30	31
cch																segment (variable)															
...																															

cch (2 bytes): An unsigned integer that specifies the length, in characters, of the [XLUnicodeStringNoCch](#) structure in the **segment** field. If **cch** is 0xFFFF, **segment** MUST NOT exist.

segment (variable): An XLUnicodeStringNoCch structure that specifies a segment of the string. This exists only if the value of the **cch** field is different than 0xFFFF.

2.4.305 SXTbl

The **SXTbl** record stores information about [multiple consolidation ranges](#).

0	1	2	3	4	5	6	7	8	9	10	11	12	13	14	15	16	17	18	19	20	21	22	23	24	25	26	27	28	29	30	31
cdref																csxtbpg															

cPages	A
--------	---

cdref (2 bytes): An unsigned integer that specifies the number of multiple consolidation ranges used as [source data](#) for the [PivotCache](#). MUST be equal to the number of [DConRef](#), [DConBin](#), or [DConName](#) records that follow this record.

csxtbpg (2 bytes): An unsigned integer that specifies the number of SxTbpg records that follow this record. MUST be equal to **cdref**.

cPages (15 bits): An unsigned integer that specifies the number of optional [cache fields](#) in the [PivotCache](#), as specified by Multiple Consolidation Ranges. MUST be less than or equal to 0x0004.

A - fAutoPage (1 bit): A bit that specifies whether there is one automatically created cache field with [cache items](#) qualifying each source data **range** of the multiple consolidation ranges [PivotCache](#). MUST be a value from the following table:

Value	Meaning
0	The cache fields that qualify the source data ranges are not automatically created.
1	There is one automatically created cache field with cache items qualifying each source data range of the multiple consolidation ranges PivotCache . Each cache item qualifies one source data range.

2.4.306 SxTbpg

The **SxTbpg** record specifies properties of [source data ranges](#) for a [multiple consolidation ranges \[PivotCache\]\(#\)](#). There MUST be one SxTbpg record for each source data range. The order of the SxTbpg records corresponds to the order of the [DREF](#) records that precede this record.

0	1	2	3	4	5	6	7	8	9	10	1	2	3	4	5	6	7	8	9	20	1	2	3	4	5	6	7	8	9	30	1		
rgiitem (variable)																																	
...																																	

rgiitem (variable): An array of signed 2-byte integers that associates [cache items](#) with the range associated with this record. Each element in this array is associated with a [cache field](#), as specified in the multiple consolidation ranges overview.

The number of elements in this array MUST be equal to the value of the **cPages** field of the preceding [SXTbl](#) record and MUST be equal to the number of [SXTBRGIITM](#) records that follow this record. The n^{th} element in this array is associated with the n^{th} [SXTBRGIITM](#) record that follows this record.

Each element in this array MUST be less than the value of the **cItems** field of the associated [SXTBRGIITM](#). Each element in this array MUST be a value from the following table:

Value	Meaning
-1	Specifies that a blank cache item is used.
Greater than or equal to zero	Specifies the zero-based index of an SXString record in the collection of SXString records directly following the associated SXTBRGIITM record.

2.4.307 SXTBRGIITM

The **SXTBRGIITM** record specifies the beginning of a collection of [SXString](#) records as specified by the [Globals Substream ABNF](#). The collection of SXString records specifies the values corresponding to the [cache items](#) for an optional [cache field](#) in a [multiple consolidation ranges PivotCache](#).

0	1	2	3	4	5	6	7	8	9	10	11	12	13	14	15	16	17	18	19	20	21	22	23	24	25	26	27	28	29	30	31
cItems																															

cItems (2 bytes): An unsigned integer that specifies the number of SXString records that follow this record. MUST be less than or equal to 65534.

2.4.308 SXTH

The **SXTH** record specifies properties of a [pivot hierarchy](#).

0	1	2	3	4	5	6	7	8	9	10	11	12	13	14	15	16	17	18	19	20	21	22	23	24	25	26	27	28	29	30	31					
frtHeaderOld																																				
A	B	C	D	E	F	G	H	I	J	K	L	M	unused3																							
sxaxis																reserved																				
isxvd																																				
csxvdXI																																				
N	O	P	Q	R	unused4																stUnique (variable)															
...																																				
stDisplay (variable)																																				
...																																				
stDefault (variable)																																				
...																																				
stAll (variable)																																				
...																																				
stDimension (variable)																																				
...																																				
cisxvd																																				

rgisxvd (variable)
...
cHiddenMemberSets
rgHiddenMemberSets (variable)
...

frtHeaderOld (4 bytes): An [FrtHeaderOld](#) structure. The **frtHeaderOld.rt** field MUST be 0x080D.

A - fMeasure (1 bit): A bit that specifies whether this pivot hierarchy is an **OLAP measure**, which means it can be placed only on the [data axis](#).

B - unused1 (1 bit): Undefined and MUST be ignored.

C - fOutlineMode (1 bit): A bit that specifies whether the [pivot fields](#) representing the levels of this pivot hierarchy have the **fOutline** field of the [SXVDEx](#) record set to 1 when the pivot fields are first created. See [Subtotalling](#) for more information.

D - fEnableMultiplePageItems (1 bit): A bit that specifies whether multiple **OLAP members** can be selected when the pivot hierarchy is on the [page axis](#) of the [PivotTable view](#).

E - fSubtotalAtTop (1 bit): A bit that specifies whether the pivot fields representing the levels of this pivot hierarchy have the **fSubtotalAtTop** field of the SXVDEx record set to 1 when the pivot fields are first created. See [Subtotalling](#) for more information.

F - fSet (1 bit): A bit that specifies whether this pivot hierarchy is an **OLAP named set**. MUST be 0 if **fMeasure** is 1.

G - fDontShowFList (1 bit): A bit that specifies whether this pivot hierarchy is hidden in the list of pivot fields that can be added to or removed from the PivotTable view.

H - fAttributeHierarchy (1 bit): A bit that specifies whether this pivot hierarchy is an **attribute hierarchy**.

I - fTimeHierarchy (1 bit): A bit that specifies whether this pivot hierarchy is a **time hierarchy**.

J - fFilterInclusive (1 bit): A bit that specifies whether [manual filters](#) applied to this pivot hierarchy are inclusive or exclusive. MUST be a value from the following table:

Value	Meaning
0	OLAP members specified in the manual filter are excluded from the PivotTable view along with their descendants.
1	OLAP members specified in the manual filter are included from the PivotTable view along with their ascendants and descendants.

For more information, see [OLAP Manual Filters](#).

K - unused2 (1 bit): Undefined and MUST be ignored.

L - fKeyAttributeHierarchy (1 bit): A bit that specifies whether this pivot hierarchy is the key attribute hierarchy in the **OLAP dimension (1)**.

M - fKPI (1 bit): A bit that specifies whether this pivot hierarchy is a **key performance indicator (KPI) hierarchy**.

unused3 (19 bits): Undefined and MUST be ignored.

sxaxis (2 bytes): An [SXAxis](#) structure that specifies the axis or axes this pivot hierarchy is present on. For more information, see [PivotTable Axes](#).

- If **sxaxis.sxaxisData** is 1, then **sxaxis.sxaxisRw**, **sxaxis.sxaxisCol**, and **sxaxis.sxaxisPage** MUST be zero.
- If **sxaxis.sxaxisRw** is 1, then **sxaxis.sxaxisCol** and **sxaxis.sxaxisPage** MUST be zero.
- If **sxaxis.sxaxisCol** is 1, **sxaxis.sxaxisPage** MUST be zero.

reserved (2 bytes): MUST be zero, and MUST be ignored.

isxvd (4 bytes): A signed integer that specifies a pivot field index as specified by Pivot Fields. The pivot field index specifies the associated pivot field for this pivot hierarchy.

If the value of **sxaxis.sxaxisPage** is 1 or the value of **sxaxis.sxaxisData** is 1, then the value of this field MUST be greater than or equal to 0 and MUST be less than the value of the **cDim** field of the [SxView](#) record of the PivotTable view, and the value of **cisxvd** MUST be 0. Also, the **sxaxis** field of the [Sxvd](#) record of the referenced pivot field MUST be equal to the **sxaxis** field of this record.

If both **sxaxis.sxaxisPage** and **sxaxis.sxaxisData** are equal to 0, the value of this field MUST be ignored.

csxvdXI (4 bytes): A signed integer that specifies the number of pivot fields in the PivotTable view on PivotTable axes for this pivot hierarchy. MUST be greater than or equal to 0.

If **sxaxis.sxaxisPage** is 1 or **sxaxis.sxaxisData** is 1, then the value of this field MUST be 1.

If **sxaxis.sxaxisPage** is 0, **sxaxis.sxaxisData** is 0, **sxaxis.sxaxisRw** is 0 and **sxaxis.sxaxisCol** is 0, the value of this field MUST be 0.

If **sxaxis.sxaxisRw** is 1 or **sxaxis.sxaxisCol** is 1, the restrictions on the value of this field vary depending on the value of the **stAll** string, as specified in the following table:

stAll	Value of csxvdXI
Empty	MUST be equal to the value of cisxvd
Not empty	MUST be equal to cisxvd - 1

N - fDragToRow (1 bit): A bit that specifies whether this pivot hierarchy can be placed on the [row axis](#) of the PivotTable view. MUST be 0 if **fMeasure** is 1.

O - fDragToColumn (1 bit): A bit that specifies whether this pivot hierarchy can be placed on the [column axis](#) of the PivotTable view. MUST be 0 if **fMeasure** is 1.

P - fDragToPage (1 bit): A bit that specifies whether this pivot hierarchy can be placed on the page axis of the PivotTable view. MUST be 0 if **fMeasure** is 1.

Q - fDragToData (1 bit): A bit that specifies whether this pivot hierarchy can be placed on the data axis of the PivotTable view.

R - fDragToHide (1 bit): A bit that specifies whether this pivot hierarchy can be removed from the PivotTable view.

unused4 (11 bits): Undefined and MUST be ignored.

stUnique (variable): An [XLUnicodeString](#) structure that specifies the **MDX unique name** of this pivot hierarchy. The length of the string MUST be greater than zero and less than or equal to 255.

stDisplay (variable): An [XLUnicodeString](#) structure that specifies the display name of this pivot hierarchy. The length of the string MUST be greater than zero and less than or equal to 255.

stDefault (variable): An [XLUnicodeString](#) structure that specifies the MDX unique name of the default **member (2)** of this pivot hierarchy. The length of the string MUST be less than or equal to 255.

stAll (variable): An [XLUnicodeString](#) structure that specifies the unique name of the **ALL** member (2) of this pivot hierarchy. The length of the string MUST be less than or equal to 255. A length of zero specifies that there is no ALL member (2) of this pivot hierarchy.

stDimension (variable): An [XLUnicodeString](#) structure that specifies the unique name of the OLAP dimension (1) to which this pivot hierarchy belongs, unless the length of the string is zero. The length of the string MUST be less than or equal to 255. If **fMeasure** is 1, the length of the string MUST be zero.

cisxvd (4 bytes): An unsigned integer that specifies the number of elements in **rgisxvd**. MUST be zero if **sxaxis.sxaxisRw** is 0 and **sxaxis.sxaxisCol** is 0.

rgisxvd (variable): An array of 4-byte signed integers that specify the pivot fields associated with this pivot hierarchy. Each array element MUST be a value from the following table:

Value	Meaning
-1	No pivot field is referenced.
Greater than or equal to zero	A pivot field index, as specified by pivot fields, that specifies a pivot field that is associated with this pivot hierarchy. The referenced pivot field MUST have an sxaxis field equal to the value of the sxaxis field of this record.

This field is arranged such that the n^{th} element in the array is a reference to the Sxvd record that has a related [SXVDTE](#) record that has a value of n for its **isxtl** field. If there is no such SXVDTE for the n^{th} element, the value of the n^{th} element MUST be equal to -1.

chiddenMemberSets (4 bytes): An unsigned integer that specifies the deepest one-based level in the pivot hierarchy that has OLAP members **hidden** from the PivotTable view. If the value of **cisxvd** is greater than 0, then the value of this field also specifies the number of elements in **rgHiddenMemberSets**. If the value of **fFilterInclusive** is 1, then the value of this field MUST be 0.

rgHiddenMemberSets (variable): An array of [HiddenMemberSet](#) structures that specifies which of the OLAP members in the pivot hierarchy are hidden from the PivotTable view through manual filtering at each level of the pivot hierarchy. The index of each member (2) in the array corresponds to a level in the pivot hierarchy, beginning with index 0. MUST exist if and only if **chiddenMemberSets** is greater than 0 and **cisxvd** is greater than 0.

2.4.309 Sxvd

The **Sxvd** record specifies [pivot field](#) properties and that specifies the beginning of a collection of records as defined in the [Worksheet substream ABNF](#). This collection of records specifies details for a pivot field.

0	1	2	3	4	5	6	7	8	9	10	11	12	13	14	15	16	17	18	19	20	21	22	23	24	25	26	27	28	29	30	31
sxaxis																cSub															
A	B	C	D	E	F	G	H	I	J	K	L	M				cItm															
cchName																stName (variable)															
...																															

sxaxis (2 bytes): An [SXAxis](#) structure that specifies the [PivotTable axis](#) that this pivot field is on. If the **sxaxis.sxaxisData** field equals 1, there MUST be a corresponding [SXDI](#) record with an **isxvd** field that specifies this Sxvd record.

cSub (2 bytes): An unsigned integer that specifies the number of subtotal functions used for this pivot field. MUST equal the count of subtotal fields of this record whose value is 1. The subtotal fields of this record are **fDefault**, **fSum**, **fCounta**, **fAverage**, **fMax**, **fMin**, **fProduct**, **fCount**, **fStdev**, **fStdevp**, **fVariance**, and **fVariancep**. For more information, see [Subtotalling](#).

A - fDefault (1 bit): A bit that specifies whether the default subtotal **function** is applied. The default subtotal is separately determined for each [data item](#). If the **fDefault** field equals 1 and the **sxaxis.sxaxisRw** field equals 1 or if the **sxaxis.sxaxisCol** field equals 1 or if the **sxaxis.sxaxisPage** field equals 1, there MUST be one [SXVI](#) record with the **itmType** field of the SXVI record equal to 1. MUST be a value from the following table:

Value	Meaning
0	The default subtotal function is not applied.
1	The default subtotal function is applied.

B - fSum (1 bit): A bit that specifies whether the sum subtotal function is displayed. If the **fDefault** field equals 1, this value MUST be 0. If the **fSum** field equals 1 and the **sxaxis.sxaxisRw** field equals 1 or if the **sxaxis.sxaxisCol** field equals 1 or if the **sxaxis.sxaxisPage** field equals 1, there MUST be one SXVI record with the **itmType** field of the SXVI record equal to 2. MUST be a value from the following table:

Value	Meaning
0	The sum subtotal function is not displayed.
1	The sum subtotal function is displayed.

C - fCounta (1 bit): A bit that specifies whether the count subtotal function is displayed. If the **fDefault** field equals 1, this value MUST be 0. If the **fCounta** field equals 1 and the **sxaxis.sxaxisRw** field equals 1 or if the **sxaxis.sxaxisCol** field equals 1 or if the **sxaxis.sxaxisPage** field equals 1, there MUST be one SXVI record with the **itmType** field of the SXVI record equal to 3. MUST be a value from the following table:

Value	Meaning
0	The count subtotal function is not displayed.
1	The count subtotal function is displayed.

D - fAverage (1 bit): A bit that specifies whether the average subtotal function is displayed. If the **fDefault** field equals 1, this value MUST be 0. If the **fAverage** field equals 1 and the **sxaxis.sxaxisRw** field equals 1 or if the **sxaxis.sxaxisCol** field equals 1 or if the **sxaxis.sxaxisPage** field equals 1, there MUST be one SXVI record with the **itmType** field of the SXVI record equal to 4. MUST be a value from the following table:

Value	Meaning
0	The average subtotal function is not displayed.
1	The average subtotal function is displayed.

E - fMax (1 bit): A bit that specifies whether the max subtotal function is displayed. If the **fDefault** field equals 1, this value MUST be 0. If the **fMax** field equals 1 and the **sxaxis.sxaxisRw** field equals 1 or if the **sxaxis.sxaxisCol** field equals 1 or if the **sxaxis.sxaxisPage** field equals 1, there MUST be one SXVI record with the **itmType** field of the SXVI record equal to 5. MUST be a value from the following table:

Value	Meaning
0	The max subtotal function is not displayed.
1	The max subtotal function is displayed.

F - fMin (1 bit): A bit that specifies whether the min subtotal function is displayed. If the **fDefault** field equals 1, this value MUST be 0. If the **fMin** field equals 1 and the **sxaxis.sxaxisRw** field equals 1 or if the **sxaxis.sxaxisCol** field equals 1 or if the **sxaxis.sxaxisPage** field equals 1, there MUST be one SXVI record with the **itmType** field of the SXVI record equal to 6. MUST be a value from the following table:

Value	Meaning
0	The min subtotal function is not displayed.
1	The min subtotal function is displayed.

G - fProduct (1 bit): A bit that specifies whether the product subtotal function is displayed. If the **fDefault** field is 1, this value MUST be 0. If the **fProduct** field is 1 and the **sxaxis.sxaxisRw** field equals 1 or if the **sxaxis.sxaxisCol** field equals 1 or if the **sxaxis.sxaxisPage** field equals 1, there MUST be one SXVI record with the **itmType** field of the SXVI record equal to 7. MUST be a value from the following table:

Value	Meaning
0	The product subtotal function is not displayed.
1	The product subtotal function is displayed.

H - fCount (1 bit): A bit that specifies whether the count numbers subtotal function is displayed. If the **fDefault** field is 1, this value MUST be 0. If the **fCount** field equals 1 and the **sxaxis.sxaxisRw** field equals 1 or if the **sxaxis.sxaxisCol** field equals 1 or if the **sxaxis.sxaxisPage** field equals 1, there MUST be one SXVI record with the **itmType** field of the SXVI record equal to 8. MUST be a value from the following table:

Value	Meaning
0	The count numbers subtotal function is not displayed.
1	The count numbers subtotal function is displayed.

I - fStdev (1 bit): A bit that specifies whether the standard deviation subtotal function is displayed. If the **fDefault** field is 1, this value MUST be 0. If the **fStdev** field equals 1 and the **sxaxis.sxaxisRw** field equals 1 or if the **sxaxis.sxaxisCol** field equals 1 or if the **sxaxis.sxaxisPage** field equals 1, there MUST be one SXVI record with the **itmType** field of the SXVI record equal to 9. MUST be a value from the following table:

Value	Meaning
0	The standard deviation subtotal function is not displayed.
1	The standard deviation subtotal function is displayed.

J - fStdevp (1 bit): A bit that specifies whether the standard deviation population subtotal function is displayed. If the **fDefault** field equals 1, this value MUST be 0. If the **fStdevp** field equals 1 and the **sxaxis.sxaxisRw** field equals 1 or if the **sxaxis.sxaxisCol** field equals 1 or if the **sxaxis.sxaxisPage** field equals 1, there MUST be one SXVI record with the **itmType** field of the SXVI record equal to 10. MUST be a value from the following table:

Value	Meaning
0	The standard deviation population subtotal function is not displayed.
1	The standard deviation population subtotal function is displayed.

K - fVariance (1 bit): A bit that specifies whether the variance subtotal function is displayed. If the **fDefault** field is 1, this value MUST be 0. If the **fVariance** field is 1 and the **sxaxis.sxaxisRw** field equals 1 or if the **sxaxis.sxaxisCol** field equals 1 or if the **sxaxis.sxaxisPage** field equals 1, there MUST be one SXVI record with the **itmType** field of the SXVI record equal to 11. MUST be a value from the following table:

Value	Meaning
0	The variance subtotal function is not displayed.
1	The variance subtotal function is displayed.

L - fVariancep (1 bit): A bit that specifies whether the variance population subtotal function is displayed. If the **fDefault** field is 1, the value MUST be 0. If the **fVariancep** field equals 1 and **sxaxis.sxaxisRw** field equals 1 or if the **sxaxis.sxaxisCol** field equals 1 or if the **sxaxis.sxaxisPage** field equals 1, there MUST be one SXVI record with the **itmType** field of the SXVI record equal to 12. MUST be a value from the following table:

Value	Meaning
0	The variance population subtotal function is not displayed.
1	The variance population subtotal function is displayed.

M - reserved (4 bits): MUST be zero, and MUST be ignored.

cItm (2 bytes): A signed integer that specifies the number of [pivot items](#) for this pivot field. This value MUST match the number of SXVI records following this record and MUST be less than or equal to the following formula:

$$32500 + \text{the } \mathbf{cSub} \text{ field}$$

cchName (2 bytes): An unsigned integer that specifies the length, in characters, of the **stName** field. If the value is 0xFFFF then **stName** is NULL. The value MUST be 0xFFFF or greater than zero and less than or equal to 255.

stName (variable): An [XLUnicodeStringNoCch](#) structure that specifies the caption of this pivot field. A non-NULL value specifies that this string is used to override the **stFieldName** field in [SXFDB](#) record from the associated [cache field](#), as specified in pivot fields. The length is specified in **cchName**. This field exists only if the value of **cchName** is not 0xFFFF. If this [PivotTable view](#) is not an [OLAP PivotTable view](#) and this string is non-NULL, then **stName** MUST be unique within all Sxvd records in this PivotTable view.

2.4.310 SXVDEx

The **SXVDEx** record specifies extended [pivot field](#) properties.

0	1	2	3	4	5	6	7	8	9	10	11	12	13	14	15	16	17	18	19	20	21	22	23	24	25	26	27	28	29	30	31		
A	B	C	D	E	F	G	H	I	J	K	L	M	N	O	P	reserved3					Q	R	S	citmAutoShow									
isxdiAutoSort																isxdiAutoShow																	
ifmt																subName (variable)																	
...																																	

A - fShowAllItems (1 bit): A bit that specifies whether to show all [pivot items](#) for this pivot field, including pivot items that do not currently exist in the [source data](#). The value MUST be 0 for an [OLAP PivotTable view](#). MUST be a value from the following table:

Value	Meaning
0x0	Specifies that all pivot items are not displayed.
0x1	Specifies that all pivot items are displayed.

B - fDragToRow (1 bit): A bit that specifies whether this pivot field can be placed on the [row axis](#). This value MUST be ignored for an OLAP PivotTable view. MUST be a value from the following table:

Value	Meaning
0x0	Specifies that the user is prevented from placing this pivot field on the row axis.
0x1	Specifies that the user is not prevented from placing this pivot field on the row axis.

C - fDragToColumn (1 bit): A bit that specifies whether this pivot field can be placed on the [column axis](#). This value MUST be ignored for an OLAP PivotTable view. MUST be a value from the following table:

Value	Meaning
0x0	Specifies that the user is prevented from placing this pivot field on the column axis.
0x1	Specifies that the user is not prevented from placing this pivot field on the column axis.

D - fDragToPage (1 bit): A bit that specifies whether this pivot field can be placed on the [page axis](#). This value MUST be ignored for an OLAP PivotTable view. MUST be a value from the following table:

Value	Meaning
0x0	Specifies that the user is prevented from placing this pivot field on the page axis.
0x1	Specifies that the user is not prevented from placing this pivot field on the page axis.

E - fDragToHide (1 bit): A bit that specifies whether this pivot field can be removed from the [PivotTable view](#). This value MUST be ignored for an OLAP PivotTable view. MUST be a value from the following table:

Value	Meaning
0x0	Specifies that the user is prevented from removing this pivot field from the PivotTable view.
0x1	Specifies that the user is not prevented from removing this pivot field from the PivotTable view.

F - fNotDragToData (1 bit): A bit that specifies whether this pivot field can be placed on the [data axis](#). This value MUST be ignored for an OLAP PivotTable view. MUST be a value from the following table:

Value	Meaning
0x0	Specifies that the user is not prevented from placing this pivot field on the data axis.
0x1	Specifies that the user is prevented from placing this pivot field on the data axis.

G - reserved1 (1 bit): MUST be zero, and MUST be ignored.

H - fServerBased (1 bit): A bit that specifies whether this pivot field is server-based when on the page axis. For more information, see Source Data. A value of 1 specifies that this pivot field is a server-based pivot field.

MUST be 1 if and only if the value of the **fServerBased** field of the [SXFDB](#) record of the associated [cache field](#) of this pivot field is 1.

I - reserved2 (1 bit): MUST be zero, and MUST be ignored.

J - fAutoSort (1 bit): A bit that specifies whether AutoSort will be applied to this pivot field. For more information, see [Pivot Field Sorting](#).

K - fAscendSort (1 bit): A bit that specifies whether any AutoSort applied to this pivot field will **sort** in ascending order. MUST be a value from the following table:

Value	Meaning
0x0	Sort in descending order.
0x1	Sort in ascending order.

L - fAutoShow (1 bit): A bit that specifies whether an **AutoShow filter** is applied to this pivot field. For more information, see [Simple Filters](#).

M - fTopAutoShow (1 bit): A bit that specifies whether any AutoShow filter applied to this pivot field shows the top-ranked or bottom-ranked values. For more information, see Simple Filters. MUST be a value from the following table:

Value	Meaning
0x0	Any AutoShow filter applied to this pivot field shows the bottom-ranked values.
0x1	Any AutoShow filter applied to this pivot field shows the top-ranked values.

N - fCalculatedField (1 bit): A bit that specifies whether this pivot field is a [calculated field](#). A value of 1 specifies that this pivot field is a calculated field.

MUST be 1 if and only if the value of the **fCalculatedField** field of the SXFDB record of the cache field associated with this pivot field is 1.

O - fPageBreaksBetweenItems (1 bit): A bit that specifies whether a **page break** is inserted after each pivot item when the [PivotTable](#) is printed.

P - fHideNewItems (1 bit): A bit that specifies whether new pivot items that appear after a **refresh** are **hidden** by default. This value MUST be equal to 0 for a non-OLAP PivotTable view.

Value	Meaning
0x0	New pivot items are shown by default.
0x1	New pivot items are hidden by default.

reserved3 (5 bits): MUST be zero, and MUST be ignored.

Q - fOutline (1 bit): A bit that specifies whether this pivot field is in **outline** form. For more information, see [PivotTable layout](#).

R - fInsertBlankRow (1 bit): A bit that specifies whether to insert a blank row after each pivot item.

S - fSubtotalAtTop (1 bit): A bit that specifies whether subtotals are displayed at the top of the group when the **fOutline** field is equal to 1. For more information, see PivotTable layout.

citmAutoShow (8 bits): An unsigned integer that specifies the number of pivot items to show when the **fAutoShow** field is equal to 1. The value MUST be greater than or equal to 1 and less than or equal to 255.

isxdiAutoSort (2 bytes): A signed integer that specifies the [data item](#) that AutoSort uses when the **fAutoSort** field is equal to 1. If the value of the **fAutoSort** field is one, the value MUST be greater than or equal to zero and less than the count of [SXDI](#) records. MUST be a value from the following table:

Value	Meaning
-1	Specifies that the values of the pivot items themselves are used.
Greater than or equal to zero	Specifies a data item index, as specified in Data Items, of the data item that is used.

isxdiAutoShow (2 bytes): A signed integer that specifies the data item that AutoShow ranks by when the **fAutoShow** field is equal to 1. For more information, see Simple Filters. If the value of the **fAutoShow** field is 1, this value MUST be greater than or equal to zero and less than the count of SXDI records. MUST be a value from the following table:

Value	Meaning
-1	AutoShow is not enabled for this pivot field.
Greater than or equal to zero	Specifies a data item index, as specified in Data Items, of the data item that is used.

ifmt (2 bytes): An [IFmt](#) structure that specifies the **number format** of this pivot field.

subName (variable): An optional [SXVDEx_Opt](#) structure that specifies the name of the aggregate **function** used to calculate this pivot field's subtotals. SHOULD <131> be present.

2.4.311 SXVDEx

The **SXVDEx** record specifies **OLAP** extensions to a [pivot field](#). This record MUST NOT exist if this [PivotTable view](#) is a non-[OLAP PivotTable view](#).

The pivot field associated with this record is the pivot field with an index that equals the index of this SXVDEx record in the collection of SXVDEx records of this PivotTable view.

The count of SXVDEx records MUST equal the count of pivot fields in the OLAP PivotTable view.

0	1	2	3	4	5	6	7	8	9	10	11	12	13	14	15	16	17	18	19	20	1	2	3	4	5	6	7	8	9	30	1
frtHeaderOld																															
A	B	C	D	E	F	reserved															isxth										
isxtl																															
csxvi																															
rgsxvi (variable)																															
...																															

frtHeaderOld (4 bytes): An [FrtHeaderOld](#) structure. The **frtHeaderOld.rt** field MUST be 0x080F.

A - fTensorSort (1 bit): A bit that specifies whether the **sort order** is determined by the OLAP **source data**. See [Pivot Field Sorting](#) for more information.

B - fDrilledLevel (1 bit): A bit that specifies whether all [pivot items](#) in this pivot field are expanded. See [Collapsing](#) for more information.

C - fItemsDrilledByDefault (1 bit): A bit that specifies whether this **attribute hierarchy** is expanded by default. See [Collapsing](#) for more information.

D - fMemPropDisplayInReport (1 bit): A bit that specifies whether this [member property](#) pivot field is displayed in the [PivotTable](#) report. See [row axis](#) or [column axis](#) for more information. MUST

be 0 if the [PivotCache functionality level](#) of the [associated PivotCache](#) is less than 3. MUST be ignored if this pivot field is not a member property pivot field.

E - fMemPropDisplayInTip (1 bit): A bit that specifies whether this member property pivot field is displayed in a **ToolTip**. MUST be 0 if the PivotCache functionality level of the associated PivotCache is less than 3. MUST be ignored if this pivot field is not a member property pivot field.

F - fMemPropDisplayInCaption (1 bit): A bit that specifies whether to display member property captions from this pivot field, for a pivot field of the associated OLAP levels and associated [pivot hierarchy](#) as this pivot field, instead of the pivot item captions. The pivot field for which to display captions has an [SXAddl SXCFIELD12 SXDMemberCaption](#) record. MUST be 0 if the PivotCache functionality level of the associated PivotCache is less than 3. MUST be ignored if this pivot field is not a member property pivot field.

reserved (10 bits): MUST be zero, and MUST be ignored.

isxth (2 bytes): A signed integer that specifies the pivot hierarchy that this pivot field is associated with. See [Association of Pivot Hierarchies and Pivot Fields and Cache Fields](#) for more information. MUST be a value from the following table:

Value	Meaning
-1	This pivot field is not part of a pivot hierarchy.
Greater than or equal to zero	This specifies a pivot hierarchy index, as specified in Pivot Hierarchies, that specifies a pivot hierarchy.

MUST be greater than or equal to -1 and less than the **csxth** field of the [SXViewEx](#) record of the PivotTable view.

isxtl (4 bytes): A signed integer that specifies the zero-based index of the OLAP level associated with the pivot hierarchy. If **isxth** specifies a pivot hierarchy that is not an OLAP **Hierarchy**, this value MUST be ignored.

csxvi (4 bytes): A signed integer that specifies the number of items in the array specified by **rgsxvi**. MUST equal the count of pivot items in this pivot field.

rgsxvi (variable): An array of [SXVIFlags](#) that specifies additional properties for the pivot items in this pivot field. Each SXVIFlags in the **rgsxvi** array specifies additional properties of the pivot item with a pivot item index equal to the index of the SXVIFlags element in the **rgsxvi** array.

The number of elements in this array MUST equal **csxvi**.

2.4.312 SXVI

The **SXVI** record specifies information about a [pivot item](#).

0	1	2	3	4	5	6	7	8	9	10	11	12	13	14	15	16	17	18	19	20	21	22	23	24	25	26	27	28	29	30	31
itmType																A	B	C	D	E	reserved2										
iCache																cchName															
stName (variable)																															
...																															

itmType (2 bytes): A signed integer that specifies the pivot item type. The value MUST be one of the following values:

Value	Name	Meaning
0x0000	itmtypeData	A data value
0x0001	itmtypeDEFAULT	Default subtotal for the pivot field
0x0002	itmtypeSUM	Sum of values in the pivot field
0x0003	itmtypeCOUNTA	Count of values in the pivot field
0x0004	itmtypeAVERAGE	Average of values in the pivot field
0x0005	itmtypeMAX	Max of values in the pivot field
0x0006	itmtypeMIN	Min of values in the pivot field
0x0007	itmtypePRODUCT	Product of values in the pivot field
0x0008	itmtypeCOUNT	Count of numbers in the pivot field
0x0009	itmtypeSTDEV	Statistical standard deviation (estimate) of the pivot field
0x000A	itmtypeSTDEVP	Statistical standard deviation (entire population) of the pivot field
0x000B	itmtypeVAR	Statistical variance (estimate) of the pivot field
0x000C	itmtypeVARP	Statistical variance (entire population) of the pivot field

A - fHidden (1 bit): A bit that specifies whether this pivot item is **hidden**. For more information, see [Manual Filtering](#).

MUST be zero if **itmType** is not itmtypeData. MUST be zero for [OLAP PivotTable view](#).

B - fHideDetail (1 bit): A bit that specifies whether the pivot item detail is collapsed.

MUST be zero for OLAP PivotTable view.

C - reserved1 (1 bit): MUST be zero, and MUST be ignored.

D - fFormula (1 bit): A bit that specifies whether this pivot item is a [calculated item](#).

This field MUST be zero if any of the following apply:

- **itmType** is not zero.
- This item is in an OLAP PivotTable view.
- The **sxaxisPage** field of **sxaxis** in the [Sxvd](#) record of the pivot field equals 1 (the associated Sxvd is the last Sxvd record before this record in the stream).
- The **fCalculatedField** field in the [SXVDEx](#) record of the pivot field equals 1.
- There is not an associated [SXFDB](#) record in the [associated PivotCache](#).
- The **fRangeGroup** field of the SXFDB record, of the associated [cache field](#) of the pivot field, equals 1.
- The **fCalculatedField** field of the SXFDB record, of the associated cache field of the pivot field, equals 1.

E - fMissing (1 bit): A bit that specifies if this pivot item does not exist in the **data source**.

MUST be zero if **itmType** is not zero. MUST be zero for OLAP PivotTable view.

reserved2 (11 bits): MUST be zero, and MUST be ignored.

iCache (2 bytes): A signed integer that specifies a reference to a [cache item](#). MUST be a value from the following table:

Value	Meaning
-1	No cache item is referenced.
0+	A cache item index in the cache field associated with the pivot field, as specified by Cache Items.

If **itmType** is not zero, a reference to a cache item is not specified and this value MUST be -1. Otherwise, this value MUST be greater than or equal to 0.

cchName (2 bytes): An unsigned integer that specifies the length of the **stName** string. If the value is 0xFFFF then **stName** is NULL. Otherwise, the value MUST be less than or equal to 254.

stName (variable): An [XLUnicodeStringNoCch](#) structure that specifies the name of this pivot item. If not NULL, this is used as the caption of the pivot item instead of the value in the cache item specified by **iCache**. The length of this field is specified in **cchName**. This field exists only if **cchName** is not 0xFFFF. If this is in a non-OLAP PivotTable view and this string is not NULL, it MUST be unique within all SXVI records in associated with the pivot field.

2.4.313 SxView

The **SxView** record specifies [PivotTable view](#) information and that specifies the beginning of a collection of records as defined by the [Worksheet substream ABNF](#). The collection specifies the remainder of the PivotTable view.

0	1	2	3	4	5	6	7	8	9	10	11	12	13	14	15	16	17	18	19	20	21	22	23	24	25	26	27	28	29	30	31
ref																															
...																															
rwFirstHead																rwFirstData															
colFirstData																iCache															
reserved																sxaxis4Data															
ipos4Data																cDim															
cDimRw																cDimCol															
cDimPg																cDimData															
cRw																cCol															
A	B	C	D	E	F	G	H	I	J	unused2											itblAutoFmt										
cchTableName																cchDataName															

stTable (variable)
...
stData (variable)
...

ref (8 bytes): A [Ref8U](#) structure that specifies the [PivotTable](#) report body. For more information, see [Location and Body](#).

rwFirstHead (2 bytes): An [RwU](#) structure that specifies the first row of the [row area](#). MUST be 1 if none of the axes are assigned in this PivotTable view. Otherwise, the value MUST be greater than or equal to **ref.rwFirst**.

rwFirstData (2 bytes): An [RwU](#) structure that specifies the first row of the [data area](#). MUST be 1 if none of the axes are assigned in this PivotTable view. Otherwise, it MUST be equal to the value as specified by the following formula:

$$\mathbf{rwFirstData} = \mathbf{rwFirstHead} + \mathbf{cDimCol}$$

colFirstData (2 bytes): A [ColU](#) structure that specifies the first column of the data area. It MUST be 1 if none of the axes are assigned in this PivotTable view. Otherwise, the value MUST be greater than or equal to **ref.colFirst**, and if the value of **cDimCol** or **cDimData** is not zero, it MUST be less than or equal to **ref.colLast**.

iCache (2 bytes): A signed integer that specifies the zero-based index of an [SXStreamID](#) record in the [Globals Substream](#). See [Associated PivotCache](#) for more information. MUST be greater than or equal to zero and less than the number of SXStreamID records in the Globals Substream.

reserved (2 bytes): MUST be zero, and MUST be ignored.

sxaxis4Data (2 bytes): An [SXAxis](#) structure that specifies the default axis for the [data field](#). Either the **sxaxis4Data.sxaxisRw** field MUST be 1 or the **sxaxis4Data.sxaxisCol** field MUST be 1. The **sxaxis4Data.sxaxisPage** field MUST be 0 and the **sxaxis4Data.sxaxisData** field MUST be 0.

ipos4Data (2 bytes): A signed integer that specifies the row or column position for the data field in the PivotTable view. The **sxaxis4Data** field specifies whether this is a row or column position. MUST be greater than or equal to -1 and less than or equal to 0x7FFF. A value of -1 specifies the default position.

cDim (2 bytes): A signed integer that specifies the number of [pivot fields](#) in the PivotTable view. MUST equal the number of [Sxvd](#) records following this record. MUST equal the number of fields in the associated [PivotCache](#) specified by **iCache**.

cDimRw (2 bytes): An unsigned integer that specifies the number of fields on the row axis of the PivotTable view. MUST be less than or equal to 0x7FFF. MUST equal the number of array elements in the [SxIvd](#) record in this PivotTable view that contain row items.

cDimCol (2 bytes): An unsigned integer that specifies the number of fields on the column axis of the PivotTable view. MUST be less than or equal to 0x7FFF. MUST equal the number of array elements in the [SxIvd](#) record in this PivotTable view that contain column items.

cDimPg (2 bytes): An unsigned integer that specifies the number of page fields in the PivotTable view. MUST be less than or equal to 0x7FFF. MUST equal the number of array elements in the [SXPI](#) record in this PivotTable view.

- cDimData (2 bytes):** A signed integer that specifies the number of data fields in the PivotTable view. MUST be greater than or equal to zero and less than or equal to 0x7FFF. MUST equal the number of [SXDI](#) records in this PivotTable view.
- cRw (2 bytes):** An unsigned integer that specifies the number of [pivot lines](#) in the row area of the PivotTable view. MUST be less than or equal to 0x7FFF. MUST equal the number of array elements in the first [SXLI](#) record in this PivotTable view.
- cCol (2 bytes):** An unsigned integer that specifies the number of pivot lines in the [column area](#) of the PivotTable view. MUST equal the number of array elements in the second SXLI record in this PivotTable view.
- A - fRwGrand (1 bit):** A bit that specifies whether the PivotTable contains grand totals for rows. MUST be 0 if none of the axes have been assigned in this PivotTable view.
- B - fColGrand (1 bit):** A bit that specifies whether the PivotTable contains grand totals for columns. MUST be 1 if none of the axes are assigned in this PivotTable view.
- C - unused1 (1 bit):** Undefined and MUST be ignored.
- D - fAutoFormat (1 bit):** A bit that specifies whether the PivotTable has **AutoFormat** applied.
- E - fAtrNum (1 bit):** A bit that specifies whether the PivotTable has number AutoFormat applied.
- F - fAtrFmt (1 bit):** A bit that specifies whether the PivotTable has **font** AutoFormat applied.
- G - fAtrAlc (1 bit):** A bit that specifies whether the PivotTable has alignment AutoFormat applied.
- H - fAtrBdr (1 bit):** A bit that specifies whether the PivotTable has **border** AutoFormat applied.
- I - fAtrPat (1 bit):** A bit that specifies whether the PivotTable has pattern AutoFormat applied.
- J - fAtrProc (1 bit):** A bit that specifies whether the PivotTable has width/height AutoFormat applied.
- unused2 (6 bits):** Undefined and MUST be ignored.
- itblAutoFmt (2 bytes):** An [AutoFmt8](#) structure that specifies the PivotTable AutoFormat. If the value of **itblAutoFmt** in the associated [SXViewEx9](#) record is not 1, this field is overridden by the value of **itblAutoFmt** in the associated SXViewEx9.
- cchTableName (2 bytes):** An unsigned integer that specifies the length, in characters, of **stTable**. MUST be greater than or equal to zero and less than or equal to 0x00FF.
- cchDataName (2 bytes):** An unsigned integer that specifies the length, in characters of **stData**. MUST be greater than zero and less than or equal to 0x00FE.
- stTable (variable):** An [XLUnicodeStringNoCch](#) structure that specifies the name of the PivotTable. The length of this field is specified by **cchTableName**.
- stData (variable):** An XLUnicodeStringNoCch structure that specifies the name of the data field. The length of this field is specified by **cchDataName**.

2.4.314 SXViewEx

The **SXViewEx** record specifies the beginning of a collection of records as specified in the [Worksheet substream ABNF](#). The collection of records specifies details about an [OLAP PivotTable view](#).

0	1	2	3	4	5	6	7	8	9	10	11	12	13	14	15	16	17	18	19	20	21	22	23	24	25	26	27	28	29	30	31
frtHeaderOld																															
csxth																															
csxpi																															
csxvdtex																															
cbFuture																															
rgbFuture (variable)																															
...																															

frtHeaderOld (4 bytes): An [FrtHeaderOld](#) structure. The value of the **frtHeaderOld.rt** field MUST be 0x80C.

csxth (4 bytes): A signed integer that specifies the number of [Sxth](#) records following this record. MUST be greater than or equal to 1.

csxpi (4 bytes): A signed integer that specifies the number of [SxPIEx](#) records following the Sxth records. MUST be greater than or equal to zero.

csxvdtex (4 bytes): A signed integer that specifies the number of [SxvDTEEx](#) records following the SxPIEx records. MUST be greater than or equal to zero.

cbFuture (4 bytes): An unsigned integer that specifies the count of bytes in **rgbFuture**. MUST be greater than or equal to zero and less than or equal to 1024. MUST be equal to the byte count of **rgbFuture**.

rgbFuture (variable): Information from future versions. The byte count MUST equal **cbFuture**.

2.4.315 SXViewEx9

The **SXViewEx9** record specifies extensions to the [PivotTable view](#).

0	1	2	3	4	5	6	7	8	9	10	11	12	13	14	15	16	17	18	19	20	21	22	23	24	25	26	27	28	29	30	31
rt																A	B	reserved2													
reserved3																															
C	D	E	F	G	reserved6																										
itblAutoFmt																chGrand (variable)															
...																															

rt (2 bytes): An unsigned integer that specifies the record type identifier. The value MUST be 0x0810.

A - reserved1 (1 bit): MUST be zero, and MUST be ignored.

B - fFrAlert (1 bit): A bit that specifies whether features of this [PivotTable](#) are not supported in earlier versions of the **BIFF**.

An application can alert the user of possible problems when saving as an earlier version of the BIFF.

reserved2 (14 bits): MUST be zero, and MUST be ignored.

reserved3 (4 bytes): MUST be zero, and MUST be ignored.

C - reserved4 (1 bit): MUST be zero, and MUST be ignored.

D - fPrintTitles (1 bit): A bit that specifies whether the print titles for the **worksheet** are set based on the PivotTable report. The row print titles are set to the pivot item captions on the column axis and the column print titles are set to the pivot item captions on the row axis.

E - fLineMode (1 bit): A bit that specifies whether any [pivot field](#) is in outline mode. See [Subtotalling](#) for more information.

F - reserved5 (2 bits): MUST be zero, and MUST be ignored.

G - fRepeatItemsOnEachPrintedPage (1 bit): A bit that specifies whether [pivot item](#) captions on the [row axis](#) are repeated on each printed page for pivot fields in tabular form.

reserved6 (26 bits): MUST be zero, and MUST be ignored.

itblAutoFmt (2 bytes): An [AutoFmt8](#) structure that specifies the PivotTable **AutoFormat**. If the value of this field is not 1, this field overrides the **itblAutoFmt** field in the previous [SXView](#) record.

chGrand (variable): An [XLUnicodeString](#) structure that specifies a user-entered caption to display for grand totals when the PivotTable is recalculated. The length MUST be less than or equal to 255 characters.

2.4.316 SXViewLink

The **SXViewLink** record specifies the name of the source [PivotTable view](#) associated with a [Pivot Chart](#).

0	1	2	3	4	5	6	7	8	9	10	11	12	13	14	15	16	17	18	19	20	21	22	23	24	25	26	27	28	29	30	31
rt																unused															
reserved																cch						stPivotTable (variable)									
...																															

rt (2 bytes): An unsigned integer. MUST be 0x0858.

unused (2 bytes): Undefined, and MUST be ignored.

reserved (2 bytes): MUST be zero and MUST be ignored.

cch (1 byte): An unsigned integer that specifies the count of characters of the **stPivotTable** field.

stPivotTable (variable): An [XLUnicodeStringNoCch](#) non-null-terminated, case-sensitive **Unicode** string that specifies the name of the PivotTable view associated with the Pivot Chart. The size of this field in bytes MUST be **cch**.

2.4.317 SXVS

The **SXVS** record specifies the type of [source data](#) used for a [PivotCache](#). This record is followed by a sequence of records that specify additional information about the source data.

0	1	2	3	4	5	6	7	8	9	10	11	12	13	14	15	16	17	18	19	20	21	22	23	24	25	26	27	28	29	30	31
sxvs																															

sxvs (2 bytes): An unsigned integer that specifies the type of source data used for the PivotCache. The types of records that follow this record are dictated by the value of this field. MUST be a value from the following table:

Name	Value	Meaning
SHEET	0x0001	Specifies that the source data is a range . This record MUST be followed by a DConRef record that specifies a simple range, or a DConName record that specifies a named range , or a DConBin record that specifies a built-in named range.
EXTERNAL	0x0002	Specifies that external source data is used. This record MUST be followed by a sequence of records beginning with a DbQuery record that specifies connection and query information that is used to retrieve external data .
CONSOLIDATION	0x0004	Specifies that multiple consolidation ranges are used as the source data. This record MUST be followed by a sequence of records beginning with an SXTbl record that specifies information about the multiple consolidation ranges.
SCENARIO	0x0010	The source data is populated from a temporary internal structure. In this case there is no additional source data information because the raw data does not exist as a permanent structure and the logic to produce it is application-dependent.

2.4.318 Sync

When multiple windows are used to view a **sheet** with synchronous scrolling enabled, the **Sync** record specifies the coordinates of the top-left visible **cell** of all windows.

0	1	2	3	4	5	6	7	8	9	10	11	12	13	14	15	16	17	18	19	20	21	22	23	24	25	26	27	28	29	30	31
rw																col															

rw (2 bytes): A [RwU](#) structure that specifies the row for the top-left **visible** cell of all windows.

col (2 bytes): A [ColU](#) structure that specifies the column for the top-left visible cell of all windows.

2.4.319 Table

The **Table** record specifies a **data table (1)**. This record is preceded by a single [Formula](#) record that defines the first **cell** in the data table (1). Other Formula records that represent the rest of cells in the data table (1) follow later in the file, not necessarily in a contiguous sequence. Formula records that define the cells in the data table (1) MUST have the cell field that is within the **range** specified in the

ref field of this record and MUST have their formula begin with [PtgTbl](#). Also, each cell specified in the **ref** field MUST have a Formula that is part of this table.

0	1	2	3	4	5	6	7	8	9	10	11	12	13	14	15	16	17	18	19	20	21	22	23	24	25	26	27	28	29	30	31						
ref																																					
...																A	B	C	D	E	F	reserved2															
rwInpRw																colInpRw																					
rwInpCol																colInpCol																					

ref (6 bytes): A [Ref](#) structure that specifies the range of the data table (1). The value of **ref.rwFirst.rw** MUST be greater than or equal to 1. The value of **ref.colFirst.col** MUST be greater than or equal to 1.

A - fAlwaysCalc (1 bit): A bit that specifies whether this data table (1) is recalculated as part of the next recalculation.

B - reserved1 (1 bit): MUST be zero, and MUST be ignored.

C - fRw (1 bit): A bit that specifies whether the **input cell** of a **one-variable data table** is a row input cell or a column input cell. If the value is 1, the input cell for a one-variable data table is a row input cell.

If the value of the **fTbl2** field is 1, the value of **fRw** is undefined and MUST be ignored.

D - fTbl2 (1 bit): A bit that specifies whether the data table (1) is a **two-variable data table** or a one-variable data table. If the value is 1, the data table (1) is a two-variable data table.

E - fDeleted1 (1 bit): A bit that specifies whether the cell referenced in the input cell specified by the **rwInpRw** and **colInpRw** fields is deleted.

F - fDeleted2 (1 bit): A bit that specifies whether the cell referenced in the input cell specified by the **rwInpCol** and **colInpCol** fields is deleted.

reserved2 (10 bits): MUST be zero, and MUST be ignored.

rwInpRw (2 bytes): A [RwU](#) structure that specifies either the row of a row input cell or the row of a column input cell. If the value of the **fTbl2** field is 0 and the value of the **fRw** field is 0, the value of **rwInpRw** specifies the row of a column input cell; for any other combination of the **fTbl2** and **fRw** fields, **rwInpRw** specifies the row of a row input cell. If the value of **fDeleted** field is 1, the value of **rwInpRw** MUST be 65535.

If **fTbl2** is 1, the following statement (1) holds.

If **fTbl2** is 0, exactly one of these statements holds:

- **rwInpRw** and **colInpRw** MUST specify a cell outside the bounds specified by **ref.rwFirst** - 1, **ref.rwLast**, **ref.colFirst** - 1, and **ref.colLast**.
- **rwInpRw** and **colInpRw** MUST be equal to **ref.rwFirst** - 1 and **ref.colFirst** - 1, respectively.

colInpRw (2 bytes): A [Col NegativeOne](#) structure that specifies either the column of a row input cell or the column of a column input cell. If the value of the **fTbl2** field is 0 and the value of **fRw** field is 0, the value of **colInpRw** specifies the column of the column input cell; for any other combination of the **fTbl2** and **fRw** fields, **colInpRw** specifies the column of a row input cell. If the

value of the **fDeleted** field is 1, the value of **colInpRw** MUST be -1. If the value of the **fDeleted** field is 0, the value of **colInpRw** MUST be greater than or equal to 0.

rwInpCol (2 bytes): A RwU structure that specifies the row of the column input cell. The restrictions on the value of **rwInpCol** are dictated by the value of the **fTbl2** field and the value of the **fDeleted2** field, as specified in the following table:

fTbl2	fDeleted2	rwInpCol
1	1	The value MUST be 65535.
1	0	If the colInpCol is a value between ref.colFirst - 1 and ref.colLast inclusive, rwInpCol MUST NOT be a value between ref.rwFirst - 1 and ref.rwLast inclusive.
0	1 or 0	Undefined and MUST be ignored.

colInpCol (2 bytes): A Col_NegativeOne structure that specifies the column of the column input cell. The restrictions on the value of **colInpCol** are dictated by the value of the **fTbl2** field and the value of the **fDeleted2** field, as specified in the following table:

fTbl2	fDeleted2	colInpCol
1	1	The value MUST be -1.
1	0	The value MUST be greater than or equal to 0. If the rwInpCol is a value between ref.rwFirst - 1 and ref.rwLast inclusive, colInpCol MUST NOT be a value between ref.colFirst - 1 and ref.colLast , inclusive.
0	1 or 0	Undefined and MUST be ignored.

2.4.320 TableStyle

The **TableStyle** record specifies a user-defined [table style](#) and the beginning of a collection of [TableStyleElement](#) records as specified by the [Globals Substream ABNF](#). The collection of [TableStyleElement](#) records specifies the properties of the table style.

0	1	2	3	4	5	6	7	8	9	10	11	12	13	14	15	16	17	18	19	20	21	22	23	24	25	26	27	28	29	30	31
frtHeader																															
...																															
...																															
A	B	C	reserved2															ctse													
...															cchName																
rgchName (variable)																															

...

frtHeader (12 bytes): An [FrtHeader](#) structure. The **frtHeader.rt** field MUST be 0x088F.

A - reserved1 (1 bit): MUST be zero, and MUST be ignored.

B - fIsPivot (1 bit): A bit that specifies whether the **style** can be applied to [PivotTable views](#).

C - fIsTable (1 bit): A bit that specifies whether the style can be applied to **tables**.

reserved2 (13 bits): MUST be zero, and MUST be ignored.

ctse (4 bytes): An unsigned integer that specifies the count of TableStyleElement records to follow this record. MUST be less than or equal to 28.

cchName (2 bytes): An unsigned integer that specifies the count of characters in the **rgchName** field. This value MUST be less than or equal to 255 and greater than or equal to 1.

rgchName (variable): An array of **Unicode** characters whose length is specified by **cchName** that specifies the style name.

2.4.321 TableStyleElement

The **TableStyleElement** record specifies formatting for one element of a [table style](#). Each table style element specifies the formatting to apply to a particular area of a **table** or [PivotTable view](#) when the table style is applied.

0	1	2	3	4	5	6	7	8	9	10	11	12	13	14	15	16	17	18	19	20	21	22	23	24	25	26	27	28	29	30	31
frtHeader																															
...																															
...																															
tseType																															
size																															
index																															

frtHeader (12 bytes): An [FrtHeader](#) structure. The **frtHeader.rt** field MUST be 0x0890.

tseType (4 bytes): An unsigned integer that specifies the area of the table or PivotTable view to which the formatting is applied. MUST be a value from the following table:

Value	Meaning
0x00000000	Whole table. If this table style is applied to a PivotTable view, this formatting type also applies to page field captions and page item captions.
0x00000001	Header row. If this table style is applied to a PivotTable view, this formatting type applies to the collection of rows above the data region . See <i>S</i> in the PivotTable Style Diagram.
0x00000002	Total row. If this table style is applied to a PivotTable view, this formatting type applies to the grand total row. See <i>N</i> in the PivotTable Style Diagram.

Value	Meaning
0x00000003	First column. If this table style is applied to a PivotTable view, this formatting type applies to the row label area, which can span multiple columns. See <i>R</i> in the PivotTable Style Diagram.
0x00000004	Last column. If this table style is applied to a PivotTable view, this formatting type applies to the grand total column. See <i>A</i> in the PivotTable Style Diagram.
0x00000005	Row stripe band 1
0x00000006	Row stripe band 2
0x00000007	Column stripe band 1
0x00000008	Column stripe band 2
0x00000009	First cell of Header row. If this table style is applied to a PivotTable view, this formatting type applies to cells contained in area intersected by the header row and first column.
0x0000000A	Last cell of header row. MUST be ignored if this table style is applied to a PivotTable view.
0x0000000B	First cell of Total row. MUST be ignored if this table style is applied to a PivotTable view.
0x0000000C	Last cell of Total row. MUST be ignored if this table style is applied to a PivotTable view.
0x0000000D	Outermost subtotal columns in a PivotTable view, specified by the columns displaying subtotals for the first <i>Sxvd</i> record in the <i>PIVOTVD</i> collection where the sxaxis field of the <i>Sxvd</i> record specifies the column axis . See <i>B</i> in the PivotTable Style Diagram. Used only for PivotTables.
0x0000000E	Alternating even subtotal columns in a PivotTable view, specified by the columns displaying subtotals for <i>Sxvd</i> records for which the zero-based index in the <i>PIVOTVD</i> collection is an odd number, omitting <i>Sxvd</i> records where the sxaxis field of the <i>Sxvd</i> record does not specify the column axis. See <i>C</i> in the PivotTable Style Diagram. Used only for PivotTables.
0x0000000F	Alternating odd subtotal columns in a PivotTable view, specified by the columns displaying subtotals for <i>Sxvd</i> records for which the zero-based index in the <i>PIVOTVD</i> collection is an even number greater than zero, omitting <i>Sxvd</i> records where the sxaxis field of the <i>Sxvd</i> record does not specify the column axis. See <i>D</i> in the PivotTable Style Diagram. Used only for PivotTables.
0x00000010	Outermost subtotal rows in a PivotTable view, specified by the rows displaying subtotals for the first <i>Sxvd</i> record in the <i>PIVOTVD</i> collection where the sxaxis field of the <i>Sxvd</i> record specifies the row axis . See <i>M</i> in the PivotTable Style Diagram. Used only for PivotTables.
0x00000011	Alternating even subtotal rows in a PivotTable view, specified by the rows displaying subtotals for <i>Sxvd</i> records for which the zero-based index in the <i>PIVOTVD</i> collection is an odd number, omitting <i>Sxvd</i> records where the sxaxis field of the <i>Sxvd</i> record does not specify the row axis. See <i>K</i> in the PivotTable Style Diagram. Used only for PivotTables.
0x00000012	Alternating odd subtotal rows in a PivotTable view, specified by the rows displaying subtotals for <i>Sxvd</i> records for which the zero-based index in the <i>PIVOTVD</i> collection is an even number greater than zero, omitting <i>Sxvd</i> records where the sxaxis field of the <i>Sxvd</i> record does not specify the row axis. See <i>J</i> in the PivotTable Style Diagram. Used only for PivotTables.
0x00000013	Empty rows after each subtotal row. See <i>L</i> in the PivotTable Style Diagram. Used only for PivotTables.
0x00000014	Outermost column subheadings in a PivotTable view, specified by the columns displaying pivot field captions for the first <i>Sxvd</i> record in the <i>PIVOTVD</i> collection where the sxaxis field of the <i>Sxvd</i> record specifies the column axis. See <i>O</i> in the PivotTable Style Diagram. Used only for PivotTables.
0x00000015	Alternating even column subheadings in a PivotTable view, specified by the column columns displaying pivot field captions for <i>Sxvd</i> records for which the zero-based index in the <i>PIVOTVD</i> collection is an odd number, omitting <i>Sxvd</i> records where the sxaxis field of the <i>Sxvd</i> record does not specify the column axis. See <i>P</i> in the

Value	Meaning
	PivotTable Style Diagram. Used only for PivotTables.
0x00000016	Alternating odd column subheadings in a PivotTable view, specified by the columns displaying pivot field captions for Sxvd records for which the zero-based index in the PIVOTVD collection is an even number greater than zero, omitting Sxvd records where the sxaxis field of the Sxvd record does not specify the column axis. See <i>Q</i> in the PivotTable Style Diagram. Used only for PivotTables.
0x00000017	Outermost row subheadings in a PivotTable view, specified by the rows displaying pivot field captions for the first Sxvd record in the PIVOTVD collection where the sxaxis field of the Sxvd record specifies the row axis. See <i>G</i> in the PivotTable Style Diagram. Used only for PivotTables.
0x00000018	Alternating even row subheadings in a PivotTable view, specified by the rows displaying pivot field captions for Sxvd records for which the zero-based index in the PIVOTVD collection is an odd number, omitting Sxvd records where the sxaxis field of the Sxvd record does not specify the row axis. See <i>H</i> in the PivotTable Style Diagram. Used only for PivotTables.
0x00000019	Alternating odd row subheadings in a PivotTable view, specified by the rows displaying pivot field captions for Sxvd records for which the zero-based index in the PIVOTVD collection is an even number greater than zero, omitting Sxvd records where the sxaxis field of the Sxvd record does not specify the row axis. See <i>I</i> in the PivotTable Style Diagram. Used only for PivotTables.
0x0000001A	Page field captions in a PivotTable view, specified by the cells displaying pivot field captions for the Sxvd records in the PIVOTVD collection where the sxaxis field of the Sxvd record specifies the page axis . See <i>F</i> in the PivotTable Style Diagram. Used only for PivotTables.
0x0000001B	Page item captions in a PivotTable view, specified by the cells displaying pivot item captions for the Sxvd records in the PIVOTVD collection where the sxaxis field of the Sxvd record specifies the page axis. See <i>E</i> in the PivotTable Style Diagram. Used only for PivotTables.

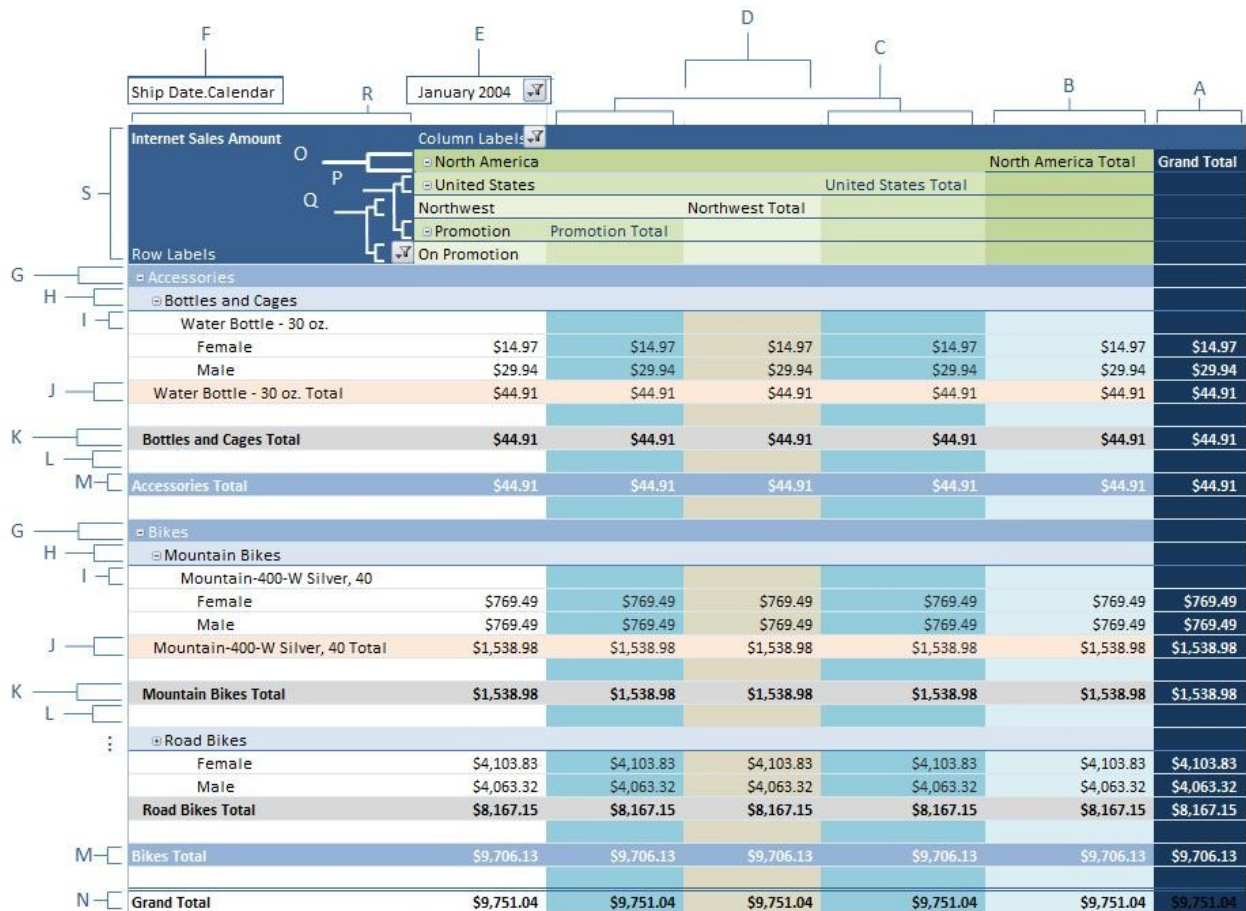

Figure 18: PivotTable-style diagram

size (4 bytes): An unsigned integer that specifies the number of rows or columns to include in a single stripe band. MUST be ignored when the value of **tseType** does not equal 0x00000005, 0x00000006, 0x00000007, or 0x00000008. MUST be greater than or equal to 1 and less than or equal to 9.

index (4 bytes): A [DXFid](#) structure that specifies the [DXF](#) record that contains the [differential formatting](#) properties for this element.

2.4.322 TableStyles

The **TableStyles** record specifies the default **table** and [PivotTable table styles](#) and specifies the beginning of a collection of [TableStyle](#) records as defined by the [Globals Substream ABNF](#). The collection of [TableStyle](#) records specifies user-defined table styles.

0	1	2	3	4	5	6	7	8	9	10	1	2	3	4	5	6	7	8	9	20	1	2	3	4	5	6	7	8	9	30	1		
frtHeader																																	
...																																	
...																																	

cts	
cchDefTableStyle	cchDefPivotStyle
rgchDefTableStyle (variable)	
...	
rgchDefPivotStyle (variable)	
...	

frtHeader (12 bytes): An [FrtHeader](#) structure. The **frtHeader.rt** field MUST be 0x088E.

cts (4 bytes): An unsigned integer that specifies the total number of table styles in this document. This is the sum of the standard built-in table styles and all of the custom table styles. This value MUST be greater than or equal to 144 (the number of built-in table styles).

cchDefTableStyle (2 bytes): An unsigned integer that specifies the count of characters in the **rgchDefTableStyle** field. This value MUST be less than or equal to 255.

cchDefPivotStyle (2 bytes): An unsigned integer that specifies the count of characters in the **rgchDefPivotStyle** field. This value MUST be less than or equal to 255.

rgchDefTableStyle (variable): An array of **Unicode** characters whose length is specified by **cchDefTableStyle** that specifies the name of the default table style.

rgchDefPivotStyle (variable): An array of Unicode characters whose length is specified by **cchDefPivotStyle** that specifies the name of the default PivotTable **style**.

2.4.323 Template

The **Template** record is an empty record that specifies whether the **workbook** is a **template**. If this record is present, the workbook is a template.

2.4.324 Text

The **Text** record specifies the properties of an [attached label](#) and specifies the beginning of a collection of records as defined by the [chart sheet](#) substream **ABNF**. This collection of records specifies an attached label.

The **fShowKey**, **fShowValue**, **fShowLabelAndPerc**, **fShowPercent**, **fShowBubbleSizes**, and **fShowLabel** fields MUST equal 0 and MUST be ignored if the current attached label does not contain an [ObjectLink](#) record that satisfies the following conditions:

- The **wLinkObj** field of the ObjectLink record equals 0x0004.
- The **wLinkVar1** field of the ObjectLink record references a [series](#).

0	1	2	3	4	5	6	7	8	9	10	11	12	13	14	15	16	17	18	19	20	21	22	23	24	25	26	27	28	29	30	31
at										vat										wBkgMode											
rgbText																															

x														
y														
dx														
dy														
A	B	C	D	E	F	G	H	I	J	K	L	M	N	icvText
dlp		unused3						O	trot					

at (1 byte): An unsigned integer that specifies the **horizontal alignment** of the text. MUST be a value from the following table:

Value	Alignment
0x01	Left-alignment if iReadingOrder specifies left-to-right reading order ; otherwise, right-alignment
0x02	Center-alignment
0x03	Right-alignment if iReadingOrder specifies left-to-right reading order; otherwise, left-alignment
0x04	Justify-alignment
0x07	Distributed alignment

vat (1 byte): An unsigned integer that specifies the **vertical alignment** of the text. MUST be a value from the following table:

Value	Alignment
0x01	Top-alignment
0x02	Center-alignment
0x03	Bottom-alignment
0x04	Justify-alignment
0x07	Distributed alignment

wBkgMode (2 bytes): An unsigned integer that specifies the display mode of the background of the text. MUST be a value from the following table:

Value	Background Mode
0x0001	Transparent background
0x0002	Opaque background

rgbText (4 bytes): A [LongRGB](#) structure that specifies the color of the text.

x (4 bytes): A signed integer that specifies the horizontal position of the text, relative to the upper-left of the **chart area** (section 2.2.3.17) in **SPRC**. This value **MUST** be ignored when this record is preceded by a **DefaultText** record or when it is followed by a **Pos** record; otherwise **MUST** be greater than or equal to 0 and less than or equal to 32767. **SHOULD** <132> be less than or equal to 4000.

y (4 bytes): A signed integer that specifies the vertical position of the text, relative to the upper-left of the chart area (section 2.2.3.17) in **SPRC**. This value **MUST** be ignored when this record is preceded by a **DefaultText** record or when it is followed by a **Pos** record; otherwise **MUST** be greater than or equal to 0 and less than or equal to 32767. **SHOULD** <133> be less than or equal to 4000.

dx (4 bytes): A signed integer that specifies the horizontal size of the text, relative to the chart area (section 2.2.3.17) in **SPRC**. This value **MUST** be ignored when this record is followed by a **Pos** record; otherwise **MUST** be greater than or equal to 0 and less than or equal to 32767. **SHOULD** <134> be less than or equal to 4000.

dy (4 bytes): A signed integer that specifies the vertical size of the text, relative to the chart area (section 2.2.3.17) in **SPRC**. This value **MUST** be ignored when this record is followed by a **Pos** record; otherwise **MUST** be greater than or equal to 0 and less than or equal to 32767. **SHOULD** <135> be less than or equal to 4000.

A - fAutoColor (1 bit): A bit that specifies whether the foreground text color is determined automatically.

B - fShowKey (1 bit): A bit that specifies whether the text is attached to a **legend key**.

C - fShowValue (1 bit): A bit that specifies whether the value, or the vertical value on bubble or scatter **chart groups**, is displayed in the **data label**.

If the current attached label contains a **DataLabExtContents** record and the **fPercent** field of the **DataLabExtContents** record equals 0, this field **MUST** equal the **fValue** field of the **DataLabExtContents** record.

If the current attached label does not contain a **DataLabExtContents** record and **fShowLabelAndPerc** equals 1, this field **MUST** equal 0.

This field **MUST** equal 0 if the current attached label does not contain a **DataLabExtContents** record and one or more of the following conditions are satisfied:

- The **fShowLabelAndPerc** field equals 1.
- The **fShowPercent** field equals 1.

D - unused1 (1 bit): Undefined and **MUST** be ignored.

E - fAutoText (1 bit): A bit that specifies whether the text value of this text field is automatically generated and unchanged.

F - fGenerated (1 bit): A bit that specifies whether the properties of this text field are automatically generated and unchanged.

G - fDeleted (1 bit): A bit that specifies whether this data label was deleted by the user.

H - fAutoMode (1 bit): A bit that specifies whether the **background color** is determined automatically.

I - unused2 (3 bits): Undefined and **MUST** be ignored.

J - fShowLabelAndPerc (1 bit): A bit that specifies whether the **category (2)** name and the value, represented as a percentage of the sum of the values of the series the data label is associated with, are displayed in the data label.

MUST equal 0 if the chart group type of the corresponding chart group, series, or [data point](#), is not a bar of pie, doughnut, pie, or pie of pie chart group.

This field MUST equal 1 if the current attached label contains a DataLabExtContents record and both of the following conditions are satisfied:

- The **fCatName** and **fPercent** fields of the DataLabExtContents record equal 1.
- The **fSerName**, **fValue**, and **fBubSizes** fields of the DataLabExtContents record equal 0.

This field MUST equal 0 if the current attached label contains a DataLabExtContents record and one or more of the following conditions is satisfied:

- The **fCatName** or **fPercent** fields of the DataLabExtContents record equal 0.
- The **fSerName**, **fValue**, or **fBubSizes** fields of the DataLabExtContents record equal 1.

MUST be ignored if **fAutoText** equals 0.

K - fShowPercent (1 bit): A bit that specifies whether the value, represented as a percentage of the sum of the values of the series the data label is associated with, is displayed in the data label.

MUST equal 0 if the chart group type of the corresponding chart group, series, or data point is not a bar of pie, doughnut, pie, or pie of pie chart group.

If the current attached label contains a DataLabExtContents record, this field MUST equal the value of the **fPercent** field of the DataLabExtContents record.

If the current attached label does not contain a DataLabExtContents record and **fShowLabelAndPerc** equals 1, this field MUST equal 1.

MUST be ignored if **fAutoText** equals 0.

L - fShowBubbleSizes (1 bit): A bit that specifies whether the **bubble size** is displayed in the data label.

MUST equal 0 if the chart group type of the corresponding chart group, series, or data point is not a bubble chart group.

If the current attached label contains a DataLabExtContents record and the **fPercent**, **fValue**, and **fCatName** fields of the DataLabExtContents record equal 0, this field MUST equal the **fBubSizes** field of the DataLabExtContents record.

If the current attached label contains a DataLabExtContents record and the **fPercent**, **fValue**, or **fCatName** fields of the DataLabExtContents record equal 1, this field MUST equal 0.

If the current attached label does not contain a DataLabExtContents record and **fShowPercent**, **fShowValue**, or **fShowLabel** equal 1, this field MUST equal 0.

MUST be ignored if **fAutoText** equals 0.

M - fShowLabel (1 bit): A bit that specifies whether the category (2), or the horizontal value on bubble or scatter chart groups, is displayed in the data label on a non-area chart group, or the series name is displayed in the data label on an area chart group.

This field MUST equal the **fCatNameLabel** field of the DataLabExtContents record if the current attached label contains a DataLabExtContents record, the chart group is non-area, and both of the following conditions are satisfied:

- The **fValue** field of the DataLabExtContents record equals 0.
- The **fShowLabelAndPerc** field equals 1 or the **fPercent** field equals 0.

This field MUST equal the **fCatNameLabel** field of the DataLabExtContents record if the current attached label contains a DataLabExtContents record, the chart group is area or filled radar, and the following condition is satisfied:

- The **fValue** field of the DataLabExtContents record equals 0.

If the current attached label contains a DataLabExtContents record and the **fValue** field of the DataLabExtContents record equals 1, this field MUST equal 0.

This field MUST equal 0 if the current attached label does not contain a DataLabExtContents record and one of the following conditions is satisfied:

- The **fShowValue** field equals 1.
- The **fShowLabelAndPerc** field equals 0 and the **fShowPercent** field equals 1.

MUST be ignored if **fAutoText** equals 0.

N - reserved (1 bit): MUST be zero, and MUST be ignored.

icvText (2 bytes): An [Icv](#) structure that specifies the color of the text.

dlp (4 bits): An unsigned integer that specifies the data label positioning of the text, relative to the **graph object** item the text is attached to. For all data label text fields, MUST be a value from the following table:

Data label position	Value	Value for chart group type
Auto	0x0	Pie chart group
Right	0x0	Line, Bubble, or Scatter chart group
Outside	0x0	Bar or Column chart group with fStacked equal to 0
Center	0x0	Bar or Column chart group with fStacked equal to 1
Outside End	0x1	Bar, Column, or Pie chart group
Inside End	0x2	Bar, Column, or Pie chart group
Center	0x3	Bar, Column, Line, Bubble, Scatter, or Pie chart group
Inside Base	0x4	Bar or Column chart group
Above	0x5	Line, Bubble, or Scatter chart group
Below	0x6	Line, Bubble, or Scatter chart group
Left	0x7	Line, Bubble, or Scatter

Data label position	Value	Value for chart group type
		chart group
Right	0x8	Line, Bubble, or Scatter chart group
Auto	0x9	Pie chart group
Moved by user	0xA	All

For all non-data label text fields, it MUST be 0x0.

unused3 (10 bits): Undefined and MUST be ignored.

O - iReadingOrder (2 bits): An unsigned integer that specifies the reading order of the text. MUST be a value from the following table:

Value	Reading order
0x0	The reading order is equal to the iReadingOrder value of the Text record immediately following the closest preceding Chart , DataFormat , Legend , Series , or YMult record where iReadingOrder is not equal to 0x0. If no such preceding record exists, the DefaultText settings of the chart are used. If the DefaultText settings also specify 0x0, the reading order is determined by the application.
0x1	Left-to-right
0x2	Right-to-left

trot (2 bytes): An unsigned integer that specifies the text rotation. MUST be a value from the following table:

Value	Angle description
0 to 90	Text rotated 0 to 90 degrees counter-clockwise
91 to 180	Text rotated 1 to 90 degrees clockwise (angle is trot - 90)
255	Text top-to-bottom with letters upright

2.4.325 TextPropsStream

The **TextPropsStream** record specifies additional text properties for the text in the entire [chart](#), text in the current [legend](#), text in the current **legend entry**, text in the [attached label](#), or the [axis](#) labels of the current axis. These text properties are a superset of the properties stored in the associated [Text](#) and [Font](#) records based on the following table, as specified by [Chart Sheet substream ABNF](#). In each case, the associated Font record is specified by the associated [FontX](#) record. <136>

Rule containing the TextPropsStream record	Meaning
CHARTFORMATS	Specifies additional Rich Text Format properties for the text of the entire chart. The associated Text and FontX records are contained in the attached label that is contained in the first sequence of records that conforms to the DFTTEXT rule in the chart and that is not contained in the chart group .
LD	Specifies additional Rich Text Format properties for text in the current

Rule containing the TextPropsStream record	Meaning
	legend. The associated Text and FontX records are contained in the sequence of records that conforms to the ATTACHEDLABEL rule that is contained in the collection of records conforming to the LD rule.
SERIESFORMAT	Specifies additional Rich Text Format properties for the current legend entry. The associated Text and FontX records are contained in the sequence of records that conforms to the ATTACHEDLABEL rule that immediately precedes this record contained in the sequence of records that conforms to the SERIESFORMAT rule.
ATTACHEDLABEL	Specifies additional Rich Text Format properties for the text in the attached label. The associated Text and FontX records are contained in the sequence of records that conforms to the ATTACHEDLABEL rule.
AXS	Specifies additional Rich Text Format properties for the axis labels of the current axis. The associated Text and FontX records are contained in the sequence of records that conforms to the AXS rule.

These text properties are stored in the **XML stream** (section [2.1.7.22](#)), as specified in [\[ECMA-376\]](#) Part 4, section 5.7.2.217.

An application can choose to ignore this record without loss of functionality, except for the additional text properties. If an application chooses to implement this record, the application **MUST** implement the validation **checksum** specified by the **dwChecksum** field.

0	1	2	3	4	5	6	7	8	9	10	11	12	13	14	15	16	17	18	19	20	21	22	23	24	25	26	27	28	29	30	31
frtHeader																															
...																															
...																															
dwChecksum																															
cb																															
rgb (variable)																															
...																															

frtHeader (12 bytes): An [FrtHeader](#) structure. The **frtHeader.rt** field **MUST** be 0x08A5.

dwChecksum (4 bytes): An unsigned integer that specifies the checksum of the text properties attributes related to this record. The algorithm used to calculate the checksum is specified by [\[MS-OSHARED\]](#) section 2.4.3.2. The checksum **MUST** be calculated from every property of the **property stream**, taken as an array of bytes as specified by the [TextPropsStreamChecksumData](#) structure.

The information required to build the memory stream can be gathered from the Text and Font records associated with this record, as previously specified.

When reading this record, the checksum is calculated as previously specified and compared to the **dwChecksum** value stored in this record. If the calculated checksum does not match the

dwChecksum data, the application MUST assume that the **XML stream** (section 2.1.7.22) is out of date, and the data from the associated Text and Font records MUST be used instead of the data specified by the **XML stream** (section 2.1.7.22).

cb (4 bytes): An unsigned integer that specifies the size of the **rgb** field. This field MUST contain the exact length in bytes of the **rgb** field.

rgb (variable): An array of ANSI characters that contains the **XML** representation of the text formatting properties, as defined in [ECMA-376] Part 4, section 5.7.2.217. The length of this field is specified by the **cb** field.

2.4.326 Theme

The **Theme** record specifies the **theme** in use in the document.

0	1	2	3	4	5	6	7	8	9	10	11	12	13	14	15	16	17	18	19	20	21	22	23	24	25	26	27	28	29	30	31
frtHeader																															
...																															
...																															
dwThemeVersion																															
rgb (variable)																															
...																															

frtHeader (12 bytes): An [FrtHeader](#) structure. The value of the **frtHeader.rt** field MUST be 2198.

dwThemeVersion (4 bytes): An unsigned integer that specifies the theme type. SHOULD be a value from the following table<137>:

Value	Meaning
0	Custom theme
124226	Default theme

rgb (variable): An optional byte stream that specifies the theme contents (as defined in [ECMA-376](#) Part 1, Section 14.2.7). MUST exist if **dwThemeVersion** equals 0.

2.4.327 Tick

The **Tick** record specifies the attributes of the [axis](#) labels, **major tick marks**, and **minor tick marks** associated with an axis.

0	1	2	3	4	5	6	7	8	9	10	11	12	13	14	15	16	17	18	19	20	21	22	23	24	25	26	27	28	29	30	31
tktMajor								tktMinor								tlt								wBkgMode							

rgb						
reserved1						
reserved2						
reserved3						
reserved4						
A	B	rot	C	unused	D	icv
trot						

tktMajor (1 byte): An unsigned integer that specifies the location of major tick marks. MUST be a value from the following table:

Value	Tick mark location
0x0000	None. No major tick marks are drawn on the axis.
0x0001	Inside. Major tick marks are drawn toward the plot area .
0x0002	Outside. Major tick marks are drawn away from the plot area.
0x0003	Crossing. Major tick marks are drawn evenly on both sides of the axis.

tktMinor (1 byte): An unsigned integer that specifies the location of minor tick marks. MUST be a value from the following table:

Value	Tick mark location
0x0000	None. No minor tick marks are present on the axis.
0x0001	Inside. Minor tick marks are drawn toward the plot area.
0x0002	Outside. Minor tick marks are drawn away from the plot area.
0x0003	Crossing. Minor tick marks are drawn evenly on both sides of the axis.

tlb (1 byte): An unsigned integer that specifies the location of axis labels. MUST be a value from the following table:

Value	Tick mark label location
0x0000	None. No axis labels are present on the axis.
0x0001	Low. Axis labels are drawn to the left of the plot area for a vertical axis or below the plot area for a horizontal axis for all chart group types except radar. Axis labels for radar chart group types will be drawn as if the value was 0x0003.
0x0002	High. Axis labels are drawn to the right of the plot area for a vertical axis or above the plot area for a horizontal axis for all chart group types except radar. Axis labels for radar chart group types will be drawn as if the value was 0x0003.

Value	Tick mark label location
0x0003	Next to Axis. Axis labels are drawn next to the axis.

wBkgMode (1 byte): An unsigned integer that specifies the display mode of the background of the text of the axis labels. MUST be ignored if the value of **fAutoCo** is 1. MUST be a value from the following table:

Value	Background Mode
0x0001	Transparent background
0x0002	Opaque background. The background color will match the rgbBack field in the associated AreaFormat record as specified by the AXS rule in the Chart Sheet Substream ABNF .

rgb (4 bytes): A [LongRGB](#) structure that specifies the color of the text for the axis labels. MUST be ignored if **fAutoCo** is 1.

reserved1 (4 bytes): MUST be zero, and MUST be ignored.

reserved2 (4 bytes): MUST be zero, and MUST be ignored.

reserved3 (4 bytes): MUST be zero, and MUST be ignored.

reserved4 (4 bytes): MUST be zero, and MUST be ignored.

A - fAutoCo (1 bit): A bit that specifies if the foreground text color of the axis labels is determined automatically.

Value	Meaning
0	The text uses the color specified by rgb .
1	The text uses an automatically selected foreground color, based on the computer's display settings.

B - fAutoMode (1 bit): A bit that specifies if the background color of the axis label is determined automatically.

Value	Meaning
0	The background color is specified by wBkgMode .
1	The background color is set according to the DefaultText settings of the chart .

rot (3 bits): An unsigned integer that specifies text rotation of the axis labels. MUST be a value from the following table:

Value	Text Rotation
0x0	Text is drawn with the rotation specified by the value of trot .

Value	Text Rotation
0x1	Text is drawn stacked, top-to-bottom, with the letters upright.
0x2	Text is drawn rotated at 90 degrees counterclockwise.
0x3	Text is drawn rotated at 90 degrees clockwise.

C - fAutoRot (1 bit): A bit that specifies whether the text rotation of the axis label is determined automatically.

Value	Meaning
0	The axis labels do not rotate automatically, and follow the rotation specified by rot and trot .
1	The axis labels rotate as the location of the axis changes and the value of the rot and trot fields MUST be ignored.

unused (8 bits): Undefined, and MUST be ignored.

D - iReadingOrder (2 bits): An unsigned integer that specifies the **reading order** of the axis labels. MUST be a value from the following table:

Value	Meaning
0x0	The reading order is equal to the iReadingOrder value of the Text record immediately following the closest preceding Chart , DataFormat , Legend , Series or YMult record where iReadingOrder is not equal to 0x0. If no such preceding record exists, the DefaultText settings of the chart is used. If the DefaultText settings also specify 0x0, the reading order is determined by the Application.
0x1	Left-to-right
0x2	Right-to-left

icv (2 bytes): An [Icv](#) that specifies the color of the text. The color MUST be the same as **rgb**.

trot (2 bytes): An unsigned integer that specifies the axis label's text rotation. MUST be a value from the following table:

Value	Meaning
0 to 90	Text rotated 0 to 90 degrees counterclockwise
91 to 180	Text rotated 1 to 90 degrees clockwise (angle is trot - 90)
255	Text top-to-bottom with letters upright

2.4.328 TopMargin

The **TopMargin** record specifies the top margin of the current **sheet**.

0	1	2	3	4	5	6	7	8	9	10	11	12	13	14	15	16	17	18	19	20	21	22	23	24	25	26	27	28	29	30	31
num																															
...																															

num (8 bytes): An Xnum (section [2.5.342](#)) structure that specifies the top margin of the current sheet in inches. The value MUST be greater than or equal to 0 and less than or equal to 49.

2.4.329 TxO

The **TxO** record specifies the text in a text box or a **form** control. This record can be followed by a collection of [Continue](#) records that specifies additional feature data to complete this record, as follows:

- If the value of the **cchText** field is not zero, this record does not fully specify the text. The rest of the data that MUST be specified is the text string and the **formatting runs** information. That data is specified in two sets of following Continue records:
 - **Text String Specification:** The first set of Continue records specifies the text string. Each of these Continue records contains an [XLUnicodeStringNoCch](#) structure that specifies part of the string. The total number of characters in all XLUnicodeStringNoCch MUST be **cchText**.
 - **Formatting Run Specification:** The second set of Continue records specifies formatting runs. These Continue records contain a [TxORuns](#) structure. If the size of the TxORuns structure is longer than 8,224 bytes, it is split across multiple Continue records.

0	1	2	3	4	5	6	7	8	9	10	11	12	13	14	15	16	17	18	19	20	21	22	23	24	25	26	27	28	29	30	31
A	B	C	D	E	F	G	H	rot																							
reserved4 (optional)																reserved5 (optional)															
...																controlInfo (optional)															
...																															
cchText																cbRuns															
ifntEmpty																fmla (variable)															
...																															

A - reserved1 (1 bit): MUST be zero, and MUST be ignored.

B - hAlignment (3 bits): An unsigned integer that specifies the **horizontal alignment**. The value MUST be one of the values in the following table:

Value	Meaning
1	Specifies left alignment.

Value	Meaning
2< 138 >	Specifies centered alignment.
3	Specifies right alignment.
4	Specifies justify alignment.
7	Specifies justify distributed alignment.

C - vAlignment (3 bits): An unsigned integer that specifies the **vertical alignment**. The value MUST be one of the values in the following table:

Value	Meaning
1	Specifies top alignment.
2	Specifies middle alignment.
3	Specifies bottom alignment.
4	Specifies justify alignment< 139 >.
7	Specifies justify distributed alignment.

D - reserved2 (2 bits): MUST be zero, and MUST be ignored.

E - fLockText (1 bit): A bit that specifies whether the text is **locked**.

F - reserved3 (4 bits): MUST be zero, and MUST be ignored.

G - fJustLast (1 bit): A bit that specifies whether the justify alignment or justify distributed alignment is used on the last line of the text in specific versions of the application<[140](#)>.

H - fSecretEdit (1 bit): A bit that specifies whether this is a text box used for typing passwords and hiding the actual characters being typed by the user.

rot (2 bytes): An unsigned integer that specifies the orientation of the text within the object boundary. The value MUST be one of the values in the following table:

Value	Meaning
0	Specifies no rotation.
1	Specifies stacked or vertical orientation.
2	Specifies 90-degree counter-clockwise rotation.
3	Specifies 90-degree clockwise rotation.

reserved4 (2 bytes): MUST be zero and MUST be ignored. This field MUST exist if and only if the value of **cmo.ot** in the preceding [Obj](#) record is not 0, 5, 7, 11, 12 or 14.

reserved5 (4 bytes): MUST be zero and MUST be ignored. This field MUST exist if and only if the value of **cmo.ot** in the preceding Obj record is not 0, 5, 7, 11, 12 or 14.

controlInfo (6 bytes): An optional [ControlInfo](#) structure that specifies the properties for some form controls. The field MUST exist if and only if the value of **cmo.ot** in the preceding Obj record is 0, 5, 7, 11, 12, or 14.

cchText (2 bytes): An unsigned integer that specifies the number of characters in the text string contained in the Continue records immediately following this record.

cbRuns (2 bytes): An unsigned integer that specifies the number of bytes of formatting run information in the TxORuns structure contained in the Continue records following this record. If **cchText** is 0, this value MUST be 0. Otherwise, the value MUST be greater than or equal to 16 and MUST be a multiple of 8.

ifntEmpty (2 bytes): A [FontIndex](#) structure that specifies the **font** when the value of **cchText** is 0.

fmla (variable): An [ObjFmla](#) structure that specifies the [parsed expression](#) of the formula (section [2.2.2](#)) for the text.

2.4.330 TxtQry

The **TxtQry** record specifies information for a **text query** and that specifies the beginning of a collection of [ExtString](#) records, as defined by the [Worksheet substream ABNF](#). The collection of ExtString records specifies the **connection string** for a **query** that retrieves **external data**.

0	1	2	3	4	5	6	7	8	9	10	11	12	13	14	15	16	17	18	19	20	21	22	23	24	25	26	27	28	29	30	31					
rt																reserved																				
A	B	C	D	iCpidNew											E	unused1																				
rowStartAt																																				
F	G	H	I	J	K	L	chCustom															unused2														
itwf																																				
chDecimal								chThousSep								rgtxtwf (variable)																				
...																																				
rgchFile (variable)																																				
...																																				

rt (2 bytes): An unsigned integer that specifies the record type. MUST be 0x0805.

reserved (2 bytes): MUST be zero, and MUST be ignored.

A - fFile (1 bit): A bit that specifies that the query was generated from an import text file action. MUST be 1.

B - fDelimited (1 bit): A bit that specifies whether the data is delimited. MUST be a value from the following table:

Value	Meaning
0x0	The data fields are of fixed size.
0x1	The data is delimited.

C - iCpid (2 bits): An unsigned integer that specifies the **code page** used for the origin of the file. This value is unused when the value of the **fUseNewiCpid** field is equal to 1 and the value of the **iCpidNew** field is greater than 2. MUST be a value from the following table:

Value	Meaning
0x0	Macintosh
0x1	Windows (ANSI)
0x2	MS-DOS (PC-8)

D - fPromptForFile (1 bit): A bit that specifies whether a file name is prompted for on **refresh**. MUST be a value from the following table:

Value	Meaning
0x0	Saved file location is used during refresh
0x1	Prompt for file name on refresh

iCpidNew (10 bits): An unsigned integer that specifies application-specific code page information that can be used to optimize **text importation** and can be ignored.

E - fUseNewiCpid (1 bit): A bit that specifies whether the **iCpidNew** value is used for specifying the code page instead of the **iCpid** value.

unused1 (16 bits): Undefined and MUST be ignored.

rowStartAt (4 bytes): A signed integer that specifies the row in the source file where the query begins.

F - fTab (1 bit): A bit that specifies whether the tab character is treated as a column delimiter.

G - fSpace (1 bit): A bit that specifies whether the space character is treated as a column delimiter.

H - fComma (1 bit): A bit that specifies whether the comma character is treated as a field delimiter.

I - fSemiColon (1 bit): A bit that specifies whether the semi-colon character is treated as a column delimiter.

J - fCustom (1 bit): A bit that specifies whether the custom character defined in the **chCustom** field is treated as a column delimiter.

K - fConsecutive (1 bit): A bit that specifies whether consecutive delimiters are treated as one delimiter.

L - iTextDelm (2 bits): An unsigned integer that specifies a text delimiter. MUST be a value from the following table:

Value	Meaning
0x0	Quotation mark
0x1	Apostrophe

Value	Meaning
0x2	No text delimiter

chCustom (16 bits): An unsigned integer that specifies the custom delimiter **Unicode** character. This value is used if the **fCustom** value equals 1.

unused2 (8 bits): Undefined and MUST be ignored.

itwf (4 bytes): A signed integer that specifies the number of fields in each row of data. MUST be greater than 0 and less than or equal to 256.

chDecimal (1 byte): An unsigned integer that specifies the decimal separator. MUST be a character from the **ANSI character set**.

chThousSep (1 byte): An unsigned integer that specifies the thousands separator. MUST be a character from the ANSI character set.

rgtxtwf (variable): An array of **TxtWf** that specifies the text to column fields. The size of the array is determined by the **itwf** value. The array MUST NOT be empty.

rgchFile (variable): An **XLUncodeString** structure that specifies the name of the text file that is the source of the query.

2.4.331 Uncalcd

The **Uncalcd** record specifies that formulas (section [2.2.2](#)) were pending recalculation when the file was saved.

0	1	2	3	4	5	6	7	8	9	10	11	12	13	14	15	16	17	18	19	20	21	22	23	24	25	26	27	28	29	30	31
reserved1																															

reserved1 (2 bytes): MUST be zero, and MUST be ignored.

2.4.332 Units

The **Units** record MUST be zero, and MUST be ignored.

0	1	2	3	4	5	6	7	8	9	10	11	12	13	14	15	16	17	18	19	20	21	22	23	24	25	26	27	28	29	30	31
reserved																															

reserved (2 bytes): MUST be zero, and MUST be ignored.

2.4.333 UserBView

The **UserBView** record specifies the general **custom view** settings that apply to a whole **workbook**. There are accompanying **UserSViewBegin** records that specify individual custom view settings of each **sheet**. The set of this record and the accompanying **UserSViewBegin** records share the same **GUID**.

0	1	2	3	4	5	6	7	8	9	10	11	12	13	14	15	16	17	18	19	20	21	22	23	24	25	26	27	28	29	30	31									
unused1																																								
tabId																reserved1																								
guid (16 bytes)																																								
...																																								
...																																								
x																																								
y																																								
dx																																								
dy																																								
wTabRatio																A	B	C	D	E	F	G	H	I	J	K	L	M	N											
unused2																O	P	unused3																						
wMergeInterval																st (variable)																								
...																																								

unused1 (4 bytes): Undefined and MUST be ignored.

tabId (2 bytes): A [TabId](#) structure that specifies the **active sheet** in this custom view. If the value of the **fInvalidTabId** field is 1, the value of **tabId** is undefined and MUST be ignored.

reserved1 (2 bytes): MUST be zero, and MUST be ignored.

guid (16 bytes): A GUID as specified by [\[MS-DTYP\]](#) that specifies the identity of the custom view.

x (4 bytes): A signed integer that specifies the horizontal position of the workbook window, in **pixels**.

y (4 bytes): A signed integer that specifies the vertical position of the workbook window, in pixels.

dx (4 bytes): A signed integer that specifies the width of the workbook window, in pixels. MUST be greater than or equal to 0.

dy (4 bytes): A signed integer that specifies the height of the workbook window, in pixels. MUST be greater than or equal to 0.

wTabRatio (2 bytes): An unsigned integer that specifies the ratio of the window area used to display **sheet tabs** and the window area used to display the horizontal scroll bar. The value of **wTabRatio** MUST be greater than or equal to zero and less than or equal to 1000. A value of 0 specifies that only the horizontal scroll bar is displayed. A value of 1000 specifies that only sheet tabs are displayed.

A - fDspFmlaBar (1 bit): A bit that specifies whether a **formula bar** is displayed.

B - fDspStatus (1 bit): A bit that specifies whether a status bar is displayed.

C - mdNoteDisp (2 bits): An unsigned integer that specifies whether to show **cell comment** and visual cue on each cell that has a comment. MUST be a value from the following table:

Value	Meaning
0x0	Comment and visual cue are off for each cell with a comment.
0x1	A visual cue that indicates the cell has a comment.
0x2	Comment and visual cue are on for each cell with a comment.

D - fDspHScroll (1 bit): A bit that specifies whether a horizontal scroll bar is displayed.

E - fDspVScroll (1 bit): A bit that specifies whether a vertical scroll bar is displayed.

F - fBotAdornment (1 bit): A bit that specifies whether sheet tabs are displayed.

G - fZoom (1 bit): A bit that specifies whether the workbook window is maximized. The value of **fIconic** and the value of **fZoom** MUST NOT both be 1.

H - fHideObj (2 bits): A [HideObjEnum](#) structure that specifies how **ActiveX objects**, **OLE objects**, and **drawing objects** appear in the workbook Window.

I - fPrintIncl (1 bit): A bit that specifies whether the custom view includes the **print settings** of the workbook. MUST be a value from the following table:

Value	Meaning
0x0	The custom view does not include print settings of the workbook.
0x1	The custom view includes print settings of the workbook. UserSViewBegin records that have a guid field value equal to the guid of this record specify which print settings are included in the custom view. Additionally, print titles and print areas are specified by Lb records that have Name containing the guid of this record, using the following form, where <guid> matches the value of guid with the characters left brace "{", right brace "}", and dash "-" in guid replaced by an underscore "_" character: <ul style="list-style-type: none">Print titles: Z<guid>.wvu.PrintTitlesPrint area: Z<guid>.wvu.PrintArea

J - fRowColIncl (1 bit): A bit that specifies whether the custom view includes the **hidden rows**, **hidden columns**, and **filters** for the workbook. MUST be a value from the following table:

Value	Meaning
0x0	The custom view does not include Hidden rows, hidden columns, or filter settings.
0x1	The custom view includes Hidden rows, hidden columns, or filter settings of the workbook. UserSViewBegin records that have a guid field value equal to the guid of this record specify whether Hidden rows, hidden columns, or filter settings are included

Value	Meaning
	<p>in the custom view.</p> <p>Additionally, hidden rows and hidden columns are specified by Lbl records that have Name containing the guid of this record, using the following form, where <guid> matches the value of guid with the characters left brace "{", right brace "}", and dash "-" in guid replaced by an underscore "_" character:</p> <ul style="list-style-type: none"> ▪ Hidden rows: Z<guid>.wvu.Rows ▪ Hidden columns: Z<guid>.wvu.Cols <p>Filter settings are also specified by Lbl records that have Name containing the value of guid for this record, using the following form, where <guid> matches the value of guid with the characters left brace "{", right brace "}", and dash "-" in guid replaced by an underscore "_" character:</p> <ul style="list-style-type: none"> ▪ Range being filtered: Z<guid>.wvu.FilterData ▪ Range containing filter criteria: Z<guid>.wvu.FilterCriteria

K - fInvalidTabId (1 bit): A bit that specifies whether the **tabId** field is ignored.

L - fTimedUpdate (1 bit): A bit that specifies whether updates associated with linked or **external data** are coordinated. If the value of the **fPersonalView** field is 0, the value of **fTimedUpdate** MUST be 0.

M - fAllMemChanges (1 bit): A bit that specifies whether the changes being saved have priority in a **merge conflict**. If the value of the **fTimedUpdate** field is 0, the value of **fAllMemChanges** is undefined and MUST be ignored.

N - fOnlySync (1 bit): A bit that specifies whether the automatic update merges the current changes into a **shared workbook** or whether the automatic update merges and also saves the changes. If the value of the **fPersonalView** field is 0, the value of **fOnlySync** MUST be 0.

unused2 (2 bytes): Undefined and MUST be ignored.

O - fPersonalView (1 bit): A bit that specifies whether the custom view is the personal view of a shared workbook. MUST be 0 if this is not a shared workbook.

P - fIconic (1 bit): A bit that specifies whether the workbook window is minimized. The value of **fIconic** and the value of **fZoom** MUST NOT both be 1.

unused3 (14 bits): Undefined and MUST be ignored.

wMergeInterval (2 bytes): An unsigned integer that specifies the time interval, in minutes, between automatic merges of a shared workbook. The restrictions on the value of **wMergeInterval** are dictated by the value of the **fPersonalView** field and the value of the **fTimedUpdate** field, as specified in the following table:

fPersonalView	fTimedUpdate	wMergeInterval
1	1	MUST be greater than or equal to 5 and less than or equal to 1440.
1	0	Undefined and MUST be ignored.
0	0	MUST be 65535.

st (variable): An [XLUnicodeString](#) structure that specifies the name of the custom view.

2.4.334 UserSViewBegin

The **UserSViewBegin** record specifies **custom view** settings for the current **sheet** and specifies the beginning of a collection of records as defined by the [Chart Sheet substream ABNF](#), [Dialog Sheet substream](#) ABNF, [Macro Sheet substream](#) ABNF, and [Worksheet substream](#) ABNF. The collection of records specifies custom view settings for the current sheet. There is an associated [UserBView](#) record, specified by the **guid** field, that specifies custom view settings that apply to the whole **workbook**. If the current sheet is a **chart sheet**, the [UserSViewBegin Chart](#) version of this record **MUST** be used.

0	1	2	3	4	5	6	7	8	9	10	11	12	13	14	15	16	17	18	19	20	21	22	23	24	25	26	27	28	29	30	31
guid (16 bytes)																															
...																															
...																															
iTabid																reserved1															
wScale																															
icvHdr																reserved2															
pnnSel								reserved3																reserved4							
A	B	C	D	E	F	G	H	I	J	K	L	M	N	O	P	Q	R	S	T	U	V	W	X	Y	Z	a	b				
ref8TopLeft																															
...																															
operNumX																															
...																															
operNumY																															
...																															
colRPane																rwBPane															

guid (16 bytes): A **GUID**, as specified by [\[MS-DTYP\]](#), that specifies the association with a UserBView. **MUST** equal the value of the **guid** field of the UserBView.

iTabid (2 bytes): A [TabId](#) structure that specifies the sheet of this custom view.

reserved1 (2 bytes): **MUST** be zero, and **MUST** be ignored.

wScale (4 bytes): An unsigned integer that specifies the **zoom level** of the window used to display the sheet. MUST be greater than or equal to 10 and less than or equal to 400.

icvHdr (2 bytes): An **Icv** structure that specifies the color of the **gridlines** displayed in the view. MUST be less than or equal to 64.

reserved2 (2 bytes): MUST be zero, and MUST be ignored.

pnnSel (1 byte): A **PaneType** structure that specifies the **active pane**.

reserved3 (2 bytes): MUST be zero, and MUST be ignored.

reserved4 (1 byte): MUST be zero, and MUST be ignored.

A - fShowBrks (1 bit): A bit that specifies whether **page breaks** are displayed.

B - fDspFmlaSv (1 bit): A bit that specifies whether the window used to display the sheet displays formulas or values. MUST be 0 for **dialog sheets**. MUST be a value from the following table:

Value	Meaning
0x0	The window used to display the sheet displays values.
0x1	The window used to display the sheet displays formulas.

C - fDspGridSv (1 bit): A bit that specifies whether the window used to display the sheet displays gridlines.

D - fDspRwColSv (1 bit): A bit that specifies whether the window used to display the sheet displays row and column headings. MUST be 0 for dialog sheets.

E - fDspGutsSv (1 bit): A bit that specifies whether outline symbols are displayed. MUST be 0 for dialog sheets. MUST be 1 for **macro sheets**.

F - fDspZerosSv (1 bit): A bit that specifies whether the window used to display the sheet displays zero values or suppresses display of zero values. MUST be 0 for dialog sheets. MUST be a value from the following table:

Value	Meaning
0	The window used to display the sheet displays zero values.
1	The window used to display the sheet suppresses display of zero values.

G - fHorizontal (1 bit): A bit that specifies whether the sheet is centered between the horizontal margins when printed.

H - fVertical (1 bit): A bit that specifies whether the sheet is centered between the vertical margins when printed.

I - fPrintRwCol (1 bit): A bit that specifies whether to print the row and column headings. MUST be 0 for dialog sheets. MUST be 0 if the UserBView record with **guid** field value equal to the **guid** of this record has the **fPrintIncl** field value of 0.

J - fPrintGrid (1 bit): A bit that specifies whether to print the gridlines. MUST be 0 for dialog sheets. MUST be 0 if the UserBView record with **guid** field value equals to the **guid** of this record has the **fPrintIncl** field value of 0.

K - fFitToPage (1 bit): A bit that specifies whether the **fit to page** option is enabled. MUST be 0 if the UserBView record with **guid** field value equal to the **guid** of this record has the **fPrintIncl** field value of 0.

L - fPrintArea (1 bit): A bit that specifies whether there is at least one **print area** on the sheet. If the value of **fOnePrintArea** is 1, the value of **fPrintArea** MUST be 1. MUST be 0 for dialog sheets. MUST be 0 if the UserBView record with **guid** field value equal to the **guid** of this record has the **fPrintIncl** field value of 0.

Additionally, if **fPrintArea** is 1, there MUST exist an **Lbl** record for the print area as specified in the description for the **fPrintIncl** field in UserBView.

M - fOnePrintArea (1 bit): A bit that specifies whether there is only one print area on the sheet. MUST be 0 for dialog sheets. MUST be 0 if the UserBView record with **guid** field value equal to the **guid** of this record has the **fPrintIncl** field value of 0.

Additionally, if **fOnePrintArea** is 1, there MUST exist an **Lbl** record for the print area as specified in the description for the **fPrintIncl** field in UserBView.

N - fFilterMode (1 bit): A bit that specifies whether there are **hidden cells** because of filtering. MUST be 0 for dialog sheets. MUST be 0 if the UserBView record with **guid** field value equal to the **guid** of this record has the **fRowColIncl** field value of 0.

Additionally, if **fFilterMode** is 1, there MUST exist an **Lbl** record for the **range** being filtered as specified in the description for the **fRowColIncl** field in UserBView. There can exist an **Lbl** record for the range containing **filter** criteria as specified in the description for the **fRowColIncl** field in UserBView.

O - fEzFilter (1 bit): A bit that specifies whether the **AutoFilter** icon is shown on the sheet. MUST be 0 for dialog sheets. MUST be 0 if the UserBView record with **guid** field value equal to the **guid** of this record has the **fRowColIncl** field value of 0.

Additionally, if **fEzFilter** is 1, there MUST exist an **Lbl** record for the range being filtered as specified in the description for the **fRowColIncl** field in UserBView. There can exist an **Lbl** record for the range containing filter criteria as specified in the description for the **fRowColIncl** field in UserBView.

P - fFrozen (1 bit): A bit that specifies whether the **panes** in the window used to display the sheet are **frozen**. If the value of **fFrozenNoSplit** is 1, the value of **fFrozen** MUST be 1.

Q - fFrozenNoSplit (1 bit): A bit that specifies whether the panes in the window used to display the sheet are **frozen panes** but are not **split panes**.

R - fSplitV (1 bit): A bit that specifies whether the window used to display the sheet is split vertically.

S - fSplitH (1 bit): A bit that specifies whether the window used to display the sheet is split horizontally.

T - fHiddenRw (2 bits): An unsigned integer that specifies the state of **hidden** rows, excluding the filtered rows. MUST be a value from the following table:

Value	Meaning
0x0	Indicates a hidden row is present.
0x1	Indicates a hidden row is not present.

MUST be 0 for dialog sheets. MUST be 0 if the UserBView record with **guid** field value equal to the **guid** of this record has the **fRowColIncl** field value of 0.

Additionally, if **fHiddenRw** is 1, there MUST exist an Lbl record for the hidden rows as specified in the description for the **fRowColIncl** field in UserBView.

U - fHiddenCol (1 bit): A bit that specifies whether there is at least one **hidden column** in the sheet. MUST be 0 for dialog sheets. MUST be 0 if the UserBView record with **guid** field value equal to the **guid** of this record has the **fRowColIncl** field value of 0.

Additionally, if **fHiddenRw** is 1, there MUST exist an Lbl record for the hidden columns as specified in the description for the **fRowColIncl** field in UserBView.

V - unused1 (3 bits): Undefined and MUST be ignored.

W - fFilterUnique (1 bit): A bit that specifies whether the sheet has the **advanced filter** enabled and is displaying only unique rows. MUST be 0 for dialog sheets. MUST be 0 if the UserBView record with **guid** field value equal to the **guid** of this record has the **fRowColIncl** field value of 0.

Additionally, if **fFilterUnique** is 1, there MUST exist an Lbl record for the range being filtered as specified in the description for the **fRowColIncl** field in UserBView. There can exist an Lbl record for the range containing filter criteria as specified in the description for the **fRowColIncl** field in UserBView.

X - fSheetLayoutView (1 bit): A bit that specifies whether the sheet is in the **Page Break Preview view**. Only one of this value or the value of **fPageLayoutView** can be 1. If both values are 0, the custom view is in the **Normal view**. MUST be 0 for dialog sheets and macro sheets.

Y - fPageLayoutView (1 bit): A bit that specifies whether the sheet is in the **Page Layout view**. MUST be 0 for dialog sheets and macro sheets.

Z - unused2 (1 bit): Undefined and MUST be ignored.

a - fRuler (1 bit): A bit that specifies whether the **ruler** is displayed.

b - reserved5 (2 bits): MUST be zero, and MUST be ignored.

ref8TopLeft (8 bytes): A [Ref8U](#) structure that specifies the **visible** area of the **logical top-left** pane.

operNumX (8 bytes): A **floating-point number** that specifies the left-to-right position of the start of the split pane expressed as a column number. The value MUST be greater than or equal to 0. The sum of this value and the value of **ref8TopLeft.colFirst** MUST be less than or equal to 256.

operNumY (8 bytes): A floating-point number that specifies the top-to-bottom position of the start of the split pane expressed as a row number. The value MUST be greater than or equal to 0. The sum of this value and the value of **ref8TopLeft.rowFirst** MUST be less than or equal to 65536.

colRPane (2 bytes): An unsigned integer that specifies the first visible column of the **logical right** pane. MUST be 65535 or less than or equal to 255. If the value of the **fSplitV** field is 1, the value of **colRPane** MUST be 65535. If the value of the **fSplitV** field is 0, the value of **colRPane** MUST be less than or equal to 255.

rwBPane (2 bytes): An unsigned integer that specifies the first visible row of the bottom pane. If the value of the **fSplitH** field is 1, the value of **rwBPane** MUST be 65535.

2.4.335 UserSViewBegin_Chart

The **UserSViewBegin_Chart** record specifies **custom view** settings for the current **chart sheet** and that specifies the beginning of a collection of records as defined by the [Chart Sheet substream ABNF](#). The collection of records specifies custom view settings for the current chart sheet. There is an associated [UserBView](#) record, specified by the **guid** field, that specifies custom view settings that apply to the whole **workbook**.

0	1	2	3	4	5	6	7	8	9	10	11	12	13	14	15	16	17	18	19	20	21	22	23	24	25	26	27	28	29	30	31
guid (16 bytes)																															
...																															
...																															
iTabId																															
wScale																															
reserved1																															
unused1																															
reserved2																						A	reserved3			B	C				
unused2																															
...																															
unused3																															
...																															
unused4																															
...																															
unused5																unused6															

guid (16 bytes): A **GUID**, as specified by [\[MS-DTYP\]](#), that specifies the association with a UserBView. MUST equal the value of the **guid** field of the UserBView record.

iTabId (4 bytes): A [TabId](#) structure that specifies the **sheet** of this custom view.

wScale (4 bytes): An unsigned integer that specifies the **zoom level** of the window used to display the sheet. MUST be greater than or equal to 10 and less than or equal to 400.

reserved1 (4 bytes): MUST be zero, and MUST be ignored.

unused1 (4 bytes): Undefined and MUST be ignored.

reserved2 (22 bits): MUST be zero, and MUST be ignored.

A - hsState (2 bits): An unsigned integer that specifies the **hidden** state of the chart sheet. MUST be a value from the following table:

Value	Meaning
0x0	The chart sheet is visible .
0x1	The chart sheet is hidden.

Value	Meaning
0x2	Very Hidden; the sheet is hidden and cannot be displayed using the user interface.

reserved3 (6 bits): MUST be zero, and MUST be ignored.

B - fZoomToFit (1 bit): A bit that specifies whether the zoom level is set to "Zoom to Fit Selection". SHOULD [<141>](#) be 1 if the current zoom level specified by the **wScale** field fits the current **selection**.

C - reserved4 (1 bit): MUST be zero, and MUST be ignored.

unused2 (8 bytes): Undefined and MUST be ignored.

unused3 (8 bytes): Undefined and MUST be ignored.

unused4 (8 bytes): Undefined and MUST be ignored.

unused5 (2 bytes): Undefined and MUST be ignored.

unused6 (2 bytes): Undefined and MUST be ignored.

2.4.336 UserSViewEnd

The **UserSViewEnd** record specifies the end of a collection of records, as defined by the [common productions](#) substream **ABNF** and the [Dialog Sheet substream](#) ABNF. The collection of records specifies a collection of **custom view** records.

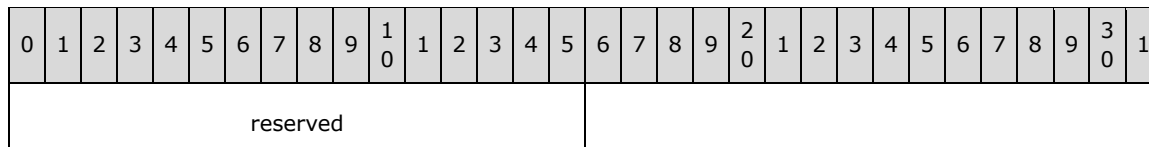

reserved (2 bytes): MUST be 1, and MUST be ignored.

2.4.337 UsesELFs

The **UsesELFs** record specifies whether the file supports **natural language formulas**.

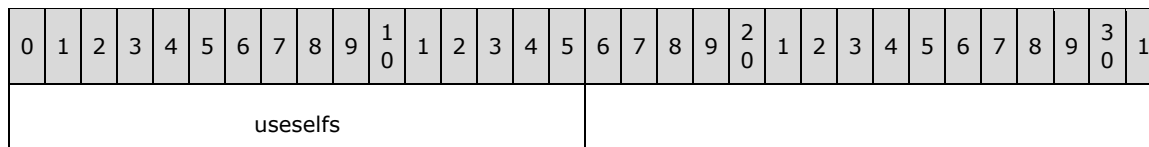

useselfs (2 bytes): A Boolean (section [2.5.14](#)) that specifies whether the file supports natural language formulas. The value SHOULD [<142>](#) be 0x0000.

2.4.338 UsrChk

The **UsrChk** record specifies the version information for the last user who opened the [shared workbook](#).

0	1	2	3	4	5	6	7	8	9	10	11	12	13	14	15	16	17	18	19	20	21	22	23	24	25	26	27	28	29	30	31
version																reserved															

version (2 bytes): An unsigned integer that specifies the **BIFF** version that was used by the last user to open the shared workbook. The value **MUST** be a value from the following table:

Value	Meaning
0x0200	BIFF2
0x0300	BIFF3
0x0400	BIFF4
0x0500	BIFF5
0x0600	BIFF8

reserved (2 bytes): **MUST** be zero, and **MUST** be ignored.

2.4.339 UsrExcl

The **UsrExcl** record specifies whether a user has acquired an exclusive lock on the [shared workbook](#) and that specifies the beginning of a collection of records as defined by the [revision](#) stream **ABNF**. The collection of records specifies properties for a shared workbook.

0	1	2	3	4	5	6	7	8	9	10	11	12	13	14	15	16	17	18	19	20	21	22	23	24	25	26	27	28	29	30	31
fExclusive																															
sdtr																															
...																															
cchUser																stUser (variable)															
...																															

fExclusive (4 bytes): A Boolean (section [2.5.14](#)) that specifies whether the user has an exclusive lock on the **workbook**. The value **MUST** be a value from the following table:

Value	Meaning
0x00000000	The user does not have an exclusive lock on the workbook.
0x00000001	The user has an exclusive lock on the workbook.

sdtr (8 bytes): A [ShortDTR](#) structure that specifies the date and time when **fExclusive** was set to 0x00000001.

cchUser (2 bytes): An unsigned integer that specifies the number of characters in **stUser** that are used to specify the name of the user who has **locked** the workbook. Characters in **stUser** that are to the right of these used characters are ignored. MUST be less than or equal to 0x0036.

stUser (variable): An [XLUnicodeStringNoCch](#) structure that specifies the name of the user who has locked the workbook. The count of characters MUST be 147.

2.4.340 UsrInfo

The **UsrInfo** record specifies information about a user who currently has the [shared workbook](#) open.

0	1	2	3	4	5	6	7	8	9	10	11	12	13	14	15	16	17	18	19	20	21	22	23	24	25	26	27	28	29	30	31
IUsrId																															
guid (16 bytes)																															
...																															
...																															
shortdtr																															
...																															
stUserName (variable)																															
...																															
unused																															

IUsrId (4 bytes): A signed integer that specifies a unique user identifier for this user.

guid (16 bytes): A **GUID**, as specified by [\[MS-DTYP\]](#), that specifies the last set of revisions synced to by this user.

shortdtr (8 bytes): A [ShortDTR](#) structure that specifies the date and time this user opened the shared workbook.

stUserName (variable): A [XLUnicodeString](#) structure that specifies the name of this user. The number of characters in this string MUST be greater than or equal to 1 and less than or equal to 54.

unused (1 byte): Undefined and MUST be ignored.

2.4.341 ValueRange

The **ValueRange** record specifies the properties of a value [axis](#).

0	1	2	3	4	5	6	7	8	9	10	11	12	13	14	15	16	17	18	19	20	21	22	23	24	25	26	27	28	29	30	31
numMin																															

...								
numMax								
...								
numMajor								
...								
numMinor								
...								
numCross								
...								
A	B	C	D	E	F	G	H	unused

numMin (8 bytes): An Xnum (section [2.5.342](#)) structure that specifies the minimum value of the value axis. MUST be less than the value of **numMax**. If the value of **fAutoMin** is 1, this field MUST be ignored.

numMax (8 bytes): An Xnum structure that specifies the maximum value of the value axis. MUST be greater than the value of **numMin**. If the value of **fAutoMax** is 1, this field MUST be ignored.

numMajor (8 bytes): An Xnum structure that specifies the interval at which **major tick marks** and **major gridlines** are displayed. MUST be greater than or equal to the value of **numMinor**. If the value of **fAutoMajor** is 1, this field MUST be ignored.

numMinor (8 bytes): An Xnum structure that specifies the interval at which **minor tick marks** and **minor gridlines** are displayed. MUST be greater than or equal to zero. If the value of **fAutoMinor** is 1, this field MUST be ignored.

numCross (8 bytes): An Xnum structure that specifies at which value the other axes in the [axis group](#) cross this value axis. If the value of **fAutoCross** is 1, this field MUST be ignored.

A - fAutoMin (1 bit): A bit that specifies whether **numMin** is calculated automatically. MUST be a value from the following table:

Value	Meaning
0	The value specified by numMin is used as the minimum value of the value axis.
1	numMin is calculated such that the data point with the minimum value can be displayed in the plot area .

B - fAutoMax (1 bit): A bit that specifies whether **numMax** is calculated automatically. MUST be a value from the following table:

Value	Meaning
0	The value specified by numMax is used as the maximum value of the value axis.

Value	Meaning
1	numMax is calculated such that the data point with the maximum value can be displayed in the plot area.

C - fAutoMajor (1 bit): A bit that specifies whether **numMajor** is calculated automatically. MUST be a value from the following table:

Value	Meaning
0	The value specified by numMajor is used as the interval at which major tick marks and major gridlines are displayed.
1	numMajor is calculated automatically.

D - fAutoMinor (1 bit): A bit that specifies whether **numMinor** is calculated automatically. MUST be a value from the following table:

Value	Meaning
0	The value specified by numMinor is used as the interval at which minor tick marks and minor gridlines are displayed.
1	numMinor is calculated automatically.

E - fAutoCross (1 bit): A bit that specifies whether **numCross** is calculated automatically. MUST be a value from the following table:

Value	Meaning
0	The value specified by numCross is used as the point at which the other axes in the axis group cross this value axis.
1	numCross is calculated so that the crossing point is displayed in the plot area.

F - fLog (1 bit): A bit that specifies whether the value axis has a logarithmic scale. MUST be a value from the following table:

Value	Meaning
0	The scale of the value axis is linear.
1	The scale of the value axis is logarithmic. The default base of the logarithmic scale is 10, unless a CrtMIFrt record follows this record, specifying the base in a XmlTkLogBaseFrt structure.

G - fReversed (1 bit): A bit that specifies whether the values on the value axis are displayed in reverse order. MUST be a value from the following table:

Value	Meaning
0	Values are displayed from smallest-to-largest, from left-to-right, or from bottom-to-top, respectively, depending on the orientation of the axis.
1	The values are displayed in reverse order, meaning largest-to-smallest, from left-to-right, or from bottom-to-top, respectively.

H - fMaxCross (1 bit): A bit that specifies whether the other axes in the axis group cross this value axis at the maximum value. MUST be a value from the following table:

Value	Meaning
0	The other axes in the axis group cross this value axis at the value specified by numCross .
1	The other axes in the axis group cross the value axis at the maximum value. If fMaxCross is 1, then both fAutoCross and numCross MUST be ignored.

unused (8 bits): Undefined and MUST be ignored.

2.4.342 VCenter

The **VCenter** record specifies whether the **sheet** is centered vertically when printed.

0	1	2	3	4	5	6	7	8	9	1	0	1	2	3	4	5	6	7	8	9	2	0	1	2	3	4	5	6	7	8	9	3	0	1
vcenter																																		

vcenter (2 bytes): A Boolean (section [2.5.14](#)) that specifies whether the sheet is centered between [TopMargin](#) and [BottomMargin](#) when printed.

2.4.343 VerticalPageBreaks

The **VerticalPageBreaks** record specifies a list of all explicit column **page breaks** in the **sheet**.

0	1	2	3	4	5	6	7	8	9	1	0	1	2	3	4	5	6	7	8	9	2	0	1	2	3	4	5	6	7	8	9	3	0	1
cbrk																rbrk (variable)																		
...																																		

cbrk (2 bytes): An unsigned integer that specifies the number of page breaks. The value MUST be less than or equal to 255.

rbrk (variable): An array of [VertBrk](#) that specifies all of the page breaks. The array MUST be sorted first by the **col** value and then by the **RowStart** value in each VertBrk. Two page breaks MUST NOT overlap. The number of VertBrk MUST equal the value of **cbrk**.

2.4.344 WebPub

The **WebPub** record specifies the information for a single **published** Web page.

0	1	2	3	4	5	6	7	8	9	1	0	1	2	3	4	5	6	7	8	9	2	0	1	2	3	4	5	6	7	8	9	3	0	1
frtRefHeaderU																																		
...																																		

...						
tws	twd	A	B	C	D	reserved2
reserved3			unused2			
nStyleId						
cb						
srcName (variable)						
...						
stFileDest (variable)						
...						
stDivId (variable)						
...						
stTitle (variable)						
...						
crtID (optional)						
frtRgb (variable)						
...						
unused3						

frtRefHeaderU (12 bytes): An [FrtRefHeaderU](#) structure. If the value of **tws** is 4, then **frtRefHeaderU.ref8** specifies the **range** of cells associated with this record and **frtRefHeaderU.grbitFrft.fFrftRef** MUST be 1. If the value of **tws** is not 4, then **frtRefHeaderU.grbitFrft.fFrftRef** MUST be zero.

tws (1 byte): An unsigned integer that specifies the type of Web source that was published. It MUST be a value from the following table:

Value	Meaning
0xFF	The source is undefined.
0x00	Workbook
0x01	Entire sheet
0x02	Print area
0x03	AutoFilter range
0x04	Range of cells
0x05	Chart

Value	Meaning
0x06	PivotTable report
0x07	Query table (external data range)
0x08	Named range

twd (1 byte): An unsigned integer that specifies the type of Web page created and whether the item is static or interactive. It MUST be a value from the following table:

Value	Meaning
0x00	Non-interactive page, only for viewing
0x01	Uses workbook functionality
0x02	Uses PivotTable functionality
0x03	Uses chart functionality

A - unused1 (1 bit): Undefined and MUST be ignored.

B - fAutoRepublish (1 bit): This bit specifies whether to republish the Web page when it is saved.

C - reserved1 (1 bit): MUST be zero and MUST be ignored.

D - fMhtml (1 bit): This bit specifies whether the file is published as a single Web page or as a Web page with references to other files.

reserved2 (12 bits): MUST be zero and MUST be ignored.

reserved3 (2 bytes): MUST be zero and MUST be ignored.

unused2 (2 bytes): Undefined and MUST be ignored.

nStyleId (4 bytes): An unsigned integer that specifies the unique identifier for this published content.

cb (4 bytes): An unsigned integer that specifies the size of the data that follows in this record according to the following formula:

size of **srcName** + size of **stFileDest** + size of **stDivId** + size of **stTitle** + size of **crtID** + size of **frtRGB** + size of **unused3**

The value MUST be greater than 0.

srcName (variable): A [WebPubString](#) structure that specifies the named range to be published. The field MUST exist if and only if the value of **tw**s is greater than 4. The character count in the string MUST be less than or equal to 255.

stFileDest (variable): A WebPubString structure that specifies the **URL** or the path to the location of the published page. The character count in the string MUST be less than or equal to 255.

stDivId (variable): A WebPubString structure that specifies the destination bookmark of the published page. The character count in the string MUST be less than or equal to 255.

stTitle (variable): A WebPubString structure that specifies the title of the **published item**.

crtID (4 bytes): An MSOSPID structure, as specified in [\[MS-ODRAW\]](#), that specifies the published chart object. This field MUST exist if and only if **tw**s equals 5.

frtRgb (variable): A binary stream that specifies the bytes reserved for future use. The size of this field in bytes is calculated according to the following formula:

$$\text{size of this record} - 30 - \text{size of srcName} - \text{size of stFileDest} - \text{size of stDivId} - \text{size of stTitle} - \text{size of crtID} <143>$$

unused3 (2 bytes): Undefined and MUST be ignored.

2.4.345 Window1

The **Window1** record specifies attributes of a window used to display a **sheet** (called "the window" within this record definition). For each Window1 record in the Globals Substream there MUST be an associated [Window2](#) record in each [chart sheet](#), [worksheet](#), [macro sheet](#), and [dialog sheet](#) substream that exists in the **workbook**. The Window2 record in a given substream associated with a given Window1 record is the Window2 record whose ordinal position in the collection of Window2 records in the containing substream is equal to the ordinal position of the given Window1 record in the collection of Window1 records in the [Globals Substream](#). Each Window2 record specifies extended properties of the associated Window1 record.

0	1	2	3	4	5	6	7	8	9	10	11	12	13	14	15	16	17	18	19	20	21	22	23	24	25	26	27	28	29	30	31					
xWn																yWn																				
dxWn																dyWn																				
A	B	C	D	E	F	G	reserved														itabCur															
itabFirst																ctabSel																				
wTabRatio																																				

xWn (2 bytes): A signed integer that specifies the horizontal position, in **twips**, of the window. The value is relative to the **logical left** edge of the **client area** of the window.

yWn (2 bytes): A signed integer that specifies the vertical position, in twips, of the window. The value is relative to the top edge of the client area of the window.

dxWn (2 bytes): A signed integer that specifies the width, in twips, of the window. MUST be greater than or equal to 1.

dyWn (2 bytes): A signed integer that specifies the height, in twips, of the window. MUST be greater than or equal to 1.

A - fHidden (1 bit): A bit that specifies whether the window is in the list of **hidden** windows.

B - fIconic (1 bit): A bit that specifies whether the window is minimized.

C - fVeryHidden (1 bit): A bit that specifies whether the window has the properties of **fHidden** and that also specifies that the user cannot see that the window is in the list of hidden windows.

D - fDspHScroll (1 bit): A bit that specifies whether a horizontal scroll bar is displayed.

E - fDspVScroll (1 bit): A bit that specifies whether a vertical scroll bar is displayed.

F - fBotAdornment (1 bit): A bit that specifies whether **sheet tabs** are displayed.

G - fNoAFDateGroup (1 bit): A bit that specifies whether dates are grouped hierarchically in the **AutoFilter** menu or listed chronologically in the AutoFilter menu.

Value	Meaning
0	Dates are grouped by year, month and day in the AutoFilter menu.
1	Dates are listed chronologically in the AutoFilter menu.

reserved (9 bits): MUST be zero, and MUST be ignored.

itabCur (2 bytes): A [TabIndex](#) structure that specifies the **selected** sheet tab.

itabFirst (2 bytes): A [TabIndex](#) structure that specifies the first displayed sheet tab.

ctabSel (2 bytes): An unsigned integer that specifies the number of sheet tabs that are selected. The value MUST be less than or equal to the number of sheets in the workbook. Each **sheet stream** in the [workbook stream](#) specifies a sheet.

wTabRatio (2 bytes): An unsigned integer that specifies the ratio of the width of the sheet tabs to the width of the horizontal scroll bar, multiplied by 1000. MUST be less than or equal to 1000.

2.4.346 Window2

The **Window2** record specifies attributes of the window used to display a **sheet** in a **workbook** and that specifies the beginning of a collection of records as defined by the [Chart Sheet substream ABNF](#), [Macro Sheet substream](#) ABNF, and [Worksheet substream](#) ABNF. The collection of records specifies the settings of a **Page Layout view** for a sheet, the zoom of the current view, the position of either **frozen panes** or **unfrozen panes**, and the **selected cells** within the sheet. When this record is contained in a macro sheet substream or a worksheet substream, it has a length of 18 bytes. When this record is contained in a chart sheet substream, it has a length of 10 bytes (which are the first 10 bytes of the original 18-byte record) and only the **fSelected** field is used. This record specifies extended properties of an associated [Window1](#) record, and that association is specified in [Window1](#).

0	1	2	3	4	5	6	7	8	9	10	11	12	13	14	15	16	17	18	19	20	21	22	23	24	25	26	27	28	29	30	31
A	B	C	D	E	F	G	H	I	J	K	L	M				rwTop															
colLeft												icvHdr																			
reserved2												wScaleSLV																			
wScaleNormal												unused																			
reserved3																															

A - fDspFmlaRt (1 bit): A bit that specifies whether the window displays formulas (section [2.2.2](#)) or values. If the value is 1, the window displays formulas (section [2.2.2](#)). This field is undefined and MUST be ignored if this record is contained in a chart sheet substream.

B - fDspGridRt (1 bit): A bit that specifies whether the window displays **gridlines**.

Value	Meaning
0	The window does not display gridlines.
1	The window displays gridlines.

This field is undefined and MUST be ignored if this record is contained in a chart sheet substream.

C - fDspRwColRt (1 bit): A bit that specifies whether the window displays row headings and column headings.

Value	Meaning
0	The window does not display row headings and column headings.
1	The window displays row headings and column headings.

This field is undefined and MUST be ignored if this record is contained in a chart sheet substream.

D - fFrozenRt (1 bit): A bit that specifies whether the panes in the window are **frozen**. The value MUST be 0 if either the value of **colLeft** is 255 or the value of **rwTop** is 65535. This field is undefined and MUST be ignored if this record is contained in a chart sheet substream.

E - fDspZerosRt (1 bit): A bit that specifies whether the window displays zero values.

Value	Meaning
0	The window displays cells that have a value of zero as blank.
1	The window displays cells that have a value of zero as a zero.

This field is undefined and MUST be ignored if this record is contained in a chart sheet substream.

F - fDefaultHdr (1 bit): A bit that specifies whether the gridlines of the window are drawn in the window's default **foreground color** or in the color specified by the value of **icvHdr**. This field is undefined and MUST be ignored if this record is contained in a chart sheet substream.

Value	Meaning
0	Gridlines of the window are drawn in the color specified by the value of icvHdr .
1	Gridlines of the window are drawn in the default foreground color of the window.

G - fRightToLeft (1 bit): A bit that specifies whether the text is displayed in **right-to-left** mode in the window.

Value	Meaning
0	The text is displayed in left-to-right mode.
1	The text is displayed in right-to-left mode.

This field is undefined and MUST be ignored if this record is contained in a chart sheet substream.

H - fDspGuts (1 bit): A bit that specifies whether the window displays the **outline state**. This field is undefined and MUST be ignored if this record is contained in a chart sheet substream.

I - fFrozenNoSplit (1 bit): A bit that specifies whether the panes in the window are frozen without **pane** splits or frozen with pane splits. If the value of **fFrozenRt** is 0, the value of **fFrozenNoSplit** MUST be 0.

Value	Meaning
0	The panes in the window are frozen with pane splits.
1	The panes in the window are frozen without pane splits.

This field is undefined and MUST be ignored if this record is contained in a chart sheet substream.

J - fSelected (1 bit): A bit that specifies whether the **sheet tab** is selected.

K - fPaged (1 bit): A bit that specifies whether the sheet is currently being displayed in the window. This field is undefined and MUST be ignored if this record is contained in a chart sheet substream.

L - fSLV (1 bit): A bit that specifies whether the sheet is in **Page Break Preview view**. This field is undefined and MUST be ignored if this record is contained in a chart sheet substream.

M - reserved1 (4 bits): MUST be zero, and MUST be ignored. This field is undefined and MUST be ignored if this record is contained in a chart sheet substream.

rwTop (2 bytes): A **RwU** structure that specifies a zero-based row index of the first **visible** row of the sheet. This field is undefined and MUST be ignored if this record is contained in a chart sheet substream.

colLeft (2 bytes): A **ColU** structure that specifies a zero-based column index of the **logical left-most** visible column. This field is undefined and MUST be ignored if this record is contained in a chart sheet substream.

icvHdr (2 bytes): An **Icv** structure that specifies the color of the gridlines. MUST be less than or equal to 64. MUST be 64 if and only if the value of **fDefaultHdr** is 1. This field is undefined and MUST be ignored if this record is contained in a chart sheet substream.

reserved2 (2 bytes): MUST be zero, and MUST be ignored. This field is undefined and MUST be ignored if this record is contained in a chart sheet substream.

wScaleSLV (2 bytes): An unsigned integer that specifies the **zoom level** in the Page Break Preview view. If the value of **fSLV** is 1 and this record has an associated **Scl** as specified in the ABNF in **Common Productions**, the value of **wScaleSLV** is undefined and MUST be ignored. MUST **<144>** be either 0 or greater than or equal to 10 and less than or equal to 400. A value of 0 specifies the default zoom level. This field MUST NOT exist if this record is contained in a chart sheet substream.

wScaleNormal (2 bytes): An unsigned integer that specifies the zoom level in the **Normal view**. If the value of **fSLV** is 0 and the value of the **fPageLayoutView** field of the **PLV**, as specified in the ABNF in Common Productions, is 0 and this record has an associated **Scl**, then the value of **wScaleNormal** is undefined and MUST be ignored. MUST **<145>** be either 0 or greater than or equal to 10 and less than or equal to 400. A value of 0 specifies the default zoom level. This field MUST NOT exist if this record is contained in a chart sheet substream.

unused (2 bytes): Undefined and MUST be ignored. This field MUST NOT exist if this record is contained in a chart sheet substream.

reserved3 (2 bytes): MUST be zero, and MUST be ignored. This field MUST NOT exist if this record is contained in a chart sheet substream.

2.4.347 WinProtect

The **WinProtect** record specifies whether the **workbook** windows can be resized or moved and whether the **window state** can be changed.

0	1	2	3	4	5	6	7	8	9	10	1	2	3	4	5	6	7	8	9	20	1	2	3	4	5	6	7	8	9	30	1
fLockWn																															

fLockWn (2 bytes): A Boolean (section [2.5.14](#)) that specifies whether the windows can be resized or moved and whether the window state can be changed. It MUST be a value from the following table:

Value	Meaning
0x0000	The workbook windows can be resized or moved and the window state can be changed.

Value	Meaning
0x0001	The workbook windows cannot be resized or moved and the window state cannot be changed.

2.4.348 WOpt

The **WOpt** record specifies options for saving as a Web page.

0	1	2	3	4	5	6	7	8	9	10	11	12	13	14	15	16	17	18	19	20	21	22	23	24	25	26	27	28	29	30	31
frtHeaderOld																															
A	B	C	D	E	F	reserved1										screenSize										reserved2					
dwPixelsPerInch																															
uiCodePage																															
rgbLocationOfComponents (variable)																															
...																															
rgbFuture (variable)																															
...																															

frtHeaderOld (4 bytes): An [FrtHeaderOld](#) structure. The value of the **frtHeaderOld.rt** field MUST be 0x080B.

A - fRelyOnCSS (1 bit): A bit that specifies whether **cascading style sheets (CSS)** is used for **font** formatting when viewing the saved file in a Web browser.

B - fOrganizeInFolder (1 bit): A bit that specifies whether all supporting files, such as background textures and graphics, are organized in a separate **folder** when saving this file as a Web page. MUST be a value from the following table:

Value	Meaning
0	All supporting files are saved in the same folder as the Web page.
1	All supporting files are organized in a separate folder.

C - fUseLongFileNames (1 bit): A bit that specifies whether **long file names** are used when saving this file as a Web page.

D - fDownloadComponents (1 bit): A bit that specifies whether the necessary **Microsoft Office Web Components** are downloaded if they are not installed when viewing the saved file in a Web browser.

E - fRelyOnVML (1 bit): A bit that specifies whether the application uses **VML** to display graphics in a Web browser.

F - fAllowPNG (1 bit): A bit that specifies whether Portable Network Graphics (PNG) format is allowed as an image format when saving this file as a Web page.

reserved1 (10 bits): MUST be zero, and MUST be ignored.

screenSize (1 byte): A **WebScreenSizeEnum**, as specified in [\[MS-OSHARED\]](#) section 2.2.1.4, that specifies the ideal minimum screen size of the target monitor used to view the saved file in a Web browser.

reserved2 (1 byte): MUST be zero, and MUST be ignored.

dwPixelsPerInch (4 bytes): An unsigned integer that specifies the density, in pixels per inch, of graphics images and **table** cells when saving this file as a Web page. The value MUST be greater than or equal to 19 and less than or equal to 480.

uiCodePage (4 bytes): An unsigned integer that specifies the **code page**. The value MUST be one of the code page values specified in [\[CODEPG\]](#), to be used by the Web browser when viewing the saved file.

rgbLocationOfComponents (variable): An [LPWideString](#) structure that specifies the **URL** or the file path to the location from which authorized users can download Microsoft Office Web Components when viewing the saved file as a Web page. The value of **rgbLocationOfComponents.cch** MUST be less than or equal to 2083.

rgbFuture (variable): A binary stream that specifies the bytes reserved for future use. The size of this field in bytes is calculated according to the following formula:

$$\text{size of this record} - 16 - \text{size of } \mathbf{rgbLocationOfComponents}$$

2.4.349 WriteAccess

The **WriteAccess** record specifies the name of the user who last created, opened, or modified the file.

0	1	2	3	4	5	6	7	8	9	10	11	12	13	14	15	16	17	18	19	20	21	22	23	24	25	26	27	28	29	30	31
userName (variable)																															
...																															
unused (variable)																															
...																															

userName (variable): An [XLUnicodeString](#) structure that specifies the **user name**. The value of **userName.cch** MUST be less than or equal to 54. If the value of **userName.rgb** is equal to "\0x20\0x20" no user name is specified.

unused (variable): Undefined and MUST be ignored. The size of this field in bytes

$$\text{MUST be equal to the value of the following formula: } (112 - \text{number of bytes of } \mathbf{userName}).$$

2.4.350 WriteProtect

The existence of the **WriteProtect** record specifies that the file is write-**protected**.

2.4.351 WsBool

The **WsBool** record specifies information about a **sheet**.

0	1	2	3	4	5	6	7	8	9	10	11	12	13	14	15	16	17	18	19	20	21	22	23	24	25	26	27	28	29	30	31
A	B		C	D	E	F	G	H	I	J	K	L	M																		

A - fShowAutoBreaks (1 bit): A bit that specifies whether **page breaks** inserted automatically are **visible** on the sheet.

B - reserved1 (3 bits): MUST be zero, and MUST be ignored.

C - fDialog (1 bit): A bit that specifies whether the sheet is a **dialog sheet**.

D - fApplyStyles (1 bit): A bit that specifies whether to apply styles in an **outline** when an outline is applied.

E - fRowSumsBelow (1 bit): A bit that specifies whether summary rows appear below an outline's detail rows.

F - fColSumsRight (1 bit): A bit that specifies whether summary columns appear to the right or left of an outline's detail columns. Valid values are specified in the following table:

Value	Meaning
0	The summary columns appear to the right, if the sheet is displayed left-to-right , or appear to the left, if the sheet is displayed right-to-left .
1	The summary columns appear to the left, if the sheet is displayed left-to-right, or appear to the right, if the sheet is displayed right-to-left.

G - fFitToPage (1 bit): A bit that specifies whether to fit the printable contents to a single page when printing this sheet.

H - reserved2 (1 bit): MUST be zero, and MUST be ignored.

I - unused (2 bits): Undefined and MUST be ignored.

J - fSyncHoriz (1 bit): A bit that specifies whether horizontal scrolling is synchronized across multiple windows displaying this sheet.

K - fSyncVert (1 bit): A bit that specifies whether vertical scrolling is synchronized across multiple windows displaying this sheet.

L - fAltExprEval (1 bit): A bit that specifies whether the sheet uses **transition formula evaluation**.

M - fAltFormulaEntry (1 bit): A bit that specifies whether the sheet uses **transition formula entry**.

2.4.352 XCT

The **XCT** record specifies the beginning of an [external cell cache](#) and that specifies the beginning of a collection of [CRN](#) records as defined in the [Globals Substream ABNF](#). The collection of CRN records specifies the values of **cells** in a **sheet** in the external cell cache.

0	1	2	3	4	5	6	7	8	9	10	11	12	13	14	15	16	17	18	19	20	21	22	23	24	25	26	27	28	29	30	31
ccrn																itab (optional)															

ccrn (2 bytes): A signed integer of which the absolute value specifies the number of CRN records immediately following this record. A value less than zero specifies that the most recent [SupBook](#) preceding this record contains a link that is not valid.

itab (2 bytes): An unsigned integer that specifies a zero-based index into the **rgst** array of the most recent instance of a SupBook preceding this record in the file. The element of the **rgst** array specified by this field contains the name of the sheet that contains the cached cells. The value of **itab** MUST be less than the value of the **ctab** field of the most recent instance of SupBook.

2.4.353 XF

The **XF** record specifies formatting properties for a **cell** or a [cell style](#).

0	1	2	3	4	5	6	7	8	9	10	11	12	13	14	15	16	17	18	19	20	21	22	23	24	25	26	27	28	29	30	31
ifnt												ifmt																			
A	B	C	D	ixfParent												Data (variable)															
...																															

ifnt (2 bytes): A [FontIndex](#) structure that specifies a [Font](#) record.

ifmt (2 bytes): An [IFmt](#) structure that specifies a **number format** identifier.

A - fLocked (1 bit): A bit that specifies whether the **locked protection** property is set to true.

B - fHidden (1 bit): A bit that specifies whether the **hidden protection** property is set to true.

C - fStyle (1 bit): A bit that specifies whether this record specifies a [cell XF](#) or a [cell style XF](#). If the value is 1, this record specifies a cell style XF.

D - f123Prefix (1 bit): A bit that specifies whether prefix characters are present in the cell. The possible prefix characters are single quote (0x27), double quote (0x22), caret (0x5E), and backslash (0x5C). [<146>](#) If **fStyle** equals 1, this field MUST equal 0.

ixfParent (12 bits): An unsigned integer that specifies the zero-based index of a cell style XF record in the collection of XF records in the [Globals Substream](#) that this cell format inherits properties from. Cell style XF records are the subset of XF records with an **fStyle** field equal to 1. See [XFIndex](#) for more information about the organization of XF records in the file.

If **fStyle** equals 1, this field SHOULD equal 0xFFFF, indicating there is no inheritance from a cell style XF. [<147>](#)

Data (variable): If the value of **fStyle** equals 0, this field contains a [CellXF](#) that specifies additional properties of the cell XF. If the value of **fStyle** equals 1, this field contains a [StyleXF](#) that specifies additional properties of the cell style XF.

2.4.354 XFCRC

The **XFCRC** record specifies the number of [XF](#) records contained in this file and that contains a **checksum** of the data in those records. This record **MUST** exist if and only if there are [XFExt](#) records in the file.

0	1	2	3	4	5	6	7	8	9	10	11	12	13	14	15	16	17	18	19	20	21	22	23	24	25	26	27	28	29	30	31
frtHeader																															
...																															
...																															
reserved																cxfs															
crc																															

frtHeader (12 bytes): An [FrtHeader](#) structure. The **frtHeader.rt** field **MUST** be 0x87C.

reserved (2 bytes): **MUST** be zero, and **MUST** be ignored.

cxfs (2 bytes): An unsigned integer that specifies the number of XF records in this file. **MUST** be greater than or equal to 16 and less than or equal to 4050.

crc (4 bytes): An unsigned integer that specifies a checksum, as specified by [\[MS-OSHARED\]](#) section 2.4.3, of the data portion of the XF records. This checksum is used to detect whether the XF records in the file were modified by an application that does not support the formatting feature extensions in XFExt records.

2.4.355 XFExt

The **XFExt** record specifies a set of formatting property extensions to an [XF](#) record in this file.

0	1	2	3	4	5	6	7	8	9	10	11	12	13	14	15	16	17	18	19	20	21	22	23	24	25	26	27	28	29	30	31
frtHeader																															
...																															
...																															
reserved1																ixfe															
reserved2																cexts															
rgExt (variable)																															

...

frtHeader (12 bytes): An [FrtHeader](#) structure. The **frtHeader.rt** field MUST be 0x087D.

reserved1 (2 bytes): MUST be zero and MUST be ignored.

ixfe (2 bytes): An [XFIndex](#) structure that specifies the XF record in the file that this record extends. MUST be less than or equal to 4050.

reserved2 (2 bytes): MUST be zero and MUST be ignored.

cexts (2 bytes): An unsigned integer that specifies the number of elements in **rgExt**.

rgExt (variable): An array of [ExtProp](#). Each array element specifies a formatting property extension.

2.4.356 YMult

The **YMult** record specifies properties of the value multiplier for a value [axis](#) and that specifies the beginning of a collection of records as defined by the [Chart Sheet substream ABNF](#). The collection of records specifies a **display units** label.

0	1	2	3	4	5	6	7	8	9	10	1	2	3	4	5	6	7	8	9	20	1	2	3	4	5	6	7	8	9	30	1			
frtHeaderOld																																		
axmid																numLabelMultiplier																		
...																																		
...																A	B	C	reserved2															

frtHeaderOld (4 bytes): An [FrtHeaderOld](#) structure. The **frtHeaderOld.rt** field MUST be 0x0857.

axmid (2 bytes): A signed integer that specifies the axis multiplier type. MUST be a value from the following table:

Value	Multiplier type
0xFFFF (-1)	Custom multiplier, multiplier value MUST be stored in numLabelMultiplier
0x0000	Values on axis are multiplied by 1.0
0x0001	Values on axis are multiplied by 100.0
0x0002	Values on axis are multiplied by 1000.0
0x0003	Values on axis are multiplied by 10,000.0
0x0004	Values on axis are multiplied by 100,000.0
0x0005	Values on axis are multiplied by 1,000,000.0
0x0006	Values on axis are multiplied by 10,000,000.0
0x0007	Values on axis are multiplied by 100,000,000.0
0x0008	Values on axis are multiplied by 1,000,000,000.0
0x0009	Values on axis are multiplied by 1,000,000,000,000.0

numLabelMultiplier (8 bytes): An Xnum (section [2.5.342](#)) structure that specifies a custom multiplier. The value on the axis are multiplied by the value of this field. MUST be greater than 0.0. If **axmid** is set to a value other than 0xFFFF, this field is ignored.

A - reserved1 (1 bit): MUST be 1, and MUST be ignored.

B - fAutoShowMultiplier (1 bit): A bit that specifies whether the display units label is displayed.

C - fBeingEdited (1 bit): A bit that specifies whether the display units label is currently being edited.

reserved2 (13 bits): MUST be zero, and MUST be ignored.

2.5 Structures

2.5.1 AddinUdf

The **AddinUdf** structure specifies the data for a **UDF** reference on an **XLL** or **COM add-in** in the [ExternName](#) record.

0	1	2	3	4	5	6	7	8	9	10	11	12	13	14	15	16	17	18	19	20	21	22	23	24	25	26	27	28	29	30	31
reserved																															
udfName (variable)																															
...																															
cb																unused (variable)															
...																															

reserved (4 bytes): MUST be zero, and MUST be ignored.

udfName (variable): A [ShortXLUnicodeString](#) that specifies the name of the referenced UDF. **udfName.cch** MUST be less than or equal to 255. For COM **add-in functions** only, it also specifies the **ProgID** of the COM object that implements the add-in function (XLL add-in functions do not have their implementing libraries uniquely specified).

cb (2 bytes): An unsigned integer that specifies the size of **unused** in bytes.

unused (variable): Undefined and MUST be ignored. The size of this field in bytes is specified by **cb**.

2.5.2 AF12CellIcon

The **AF12CellIcon** structure specifies the **icon** for an advanced **AutoFilter** comparison.

0	1	2	3	4	5	6	7	8	9	10	11	12	13	14	15	16	17	18	19	20	21	22	23	24	25	26	27	28	29	30	31
iIconSet																															
iIcon																															

iIconSet (4 bytes): An unsigned integer that specifies the **icon set** number. MUST be a value as specified in [KPISets](#).

iIcon (4 bytes): An unsigned integer that specifies the icon number within the icon set. MUST be a value as specified in the following table:

iIconSet value	Valid iIcon values
KPINIL (no icon)	0xFFFFFFFF
KPI3ARROWS	0x00000000, 0x00000001, or 0x00000002
KPI3ARROWSGRAY	0x00000000, 0x00000001, or 0x00000002
KPI3FLAGS	0x00000000, 0x00000001, or 0x00000002
KPI3TRAFFICLIGHTS1	0x00000000, 0x00000001, or 0x00000002
KPI3TRAFFICLIGHTS2	0x00000000, 0x00000001, or 0x00000002
KPI3SIGNS	0x00000000, 0x00000001, or 0x00000002
KPI3SYMBOLS	0x00000000, 0x00000001, or 0x00000002
KPI3SYMBOLS2	0x00000000, 0x00000001, or 0x00000002
KPI4ARROWS	0x00000000, 0x00000001, 0x00000002, or 0x00000003
KPI4ARROWSGRAY	0x00000000, 0x00000001, 0x00000002, or 0x00000003
KPI4REDTOBLACK	0x00000000, 0x00000001, 0x00000002, or 0x00000003
KPI4RATING	0x00000000, 0x00000001, 0x00000002, or 0x00000003
KPI4TRAFFICLIGHTS	0x00000000, 0x00000001, 0x00000002, or 0x00000003
KPI5ARROWS	0x00000000, 0x00000001, 0x00000002, 0x00000003, or 0x00000004
KPI5ARROWSGRAY	0x00000000, 0x00000001, 0x00000002, 0x00000003, or 0x00000004
KPI5RATING	0x00000000, 0x00000001, 0x00000002, 0x00000003, or 0x00000004
KPI5QUARTERS	0x00000000, 0x00000001, 0x00000002, 0x00000003, or 0x00000004

2.5.3 AF12Criteria

The **AF12Criteria** structure specifies the criteria for an advanced **AutoFilter** comparison.

0	1	2	3	4	5	6	7	8	9	10	11	12	13	14	15	16	17	18	19	20	21	22	23	24	25	26	27	28	29	30	31
doper																															
...																															
...																str (variable)															
...																															

doper (10 bytes): An [AFDOper](#) that specifies the comparison condition.

str (variable): An [XLUnicodeStringNoCch](#) that specifies the string value to use for the comparison. MUST exist if and only if **doper.vt** equals 0x06. The length MUST be equal to **doper.vtValue.cch**.

2.5.4 AF12DateInfo

The **AF12DateInfo** structure specifies the date and time for an advanced **AutoFilter** comparison.

0	1	2	3	4	5	6	7	8	9	10	11	12	13	14	15	16	17	18	19	20	21	22	23	24	25	26	27	28	29	30	31
year																month															
day																															
hour																minute															
second																unused1															
reserved1																															
nodeType																															

year (2 bytes): An unsigned integer that specifies the year.

month (2 bytes): An unsigned integer that specifies the month. MUST be greater than or equal to 1 and less than or equal to 12.

day (4 bytes): An unsigned integer that specifies the day of the month. MUST be greater than or equal to 1 [<148>](#) and less than or equal to 31.

hour (2 bytes): An unsigned integer that specifies the hour. MUST be greater than or equal to 0 and less than or equal to 23.

minute (2 bytes): An unsigned integer that specifies the minute. MUST be greater than or equal to 0 and less than or equal to 59.

second (2 bytes): An unsigned integer that specifies the second. MUST be greater than or equal to 0 and less than or equal to 59.

unused1 (2 bytes): Undefined and MUST be ignored.

reserved1 (4 bytes): MUST be zero, and MUST be ignored.

nodeType (4 bytes): An unsigned integer that specifies the date and time to filter on. MUST be one of the values from the table:

Value	Meaning
0x00000000	Filter on year field.
0x00000001	Filter on year and month fields.
0x00000002	Filter on year , month , and day fields.
0x00000003	Filter on year , month , day , and hour fields.
0x00000004	Filter on year , month , day , hour , and minute fields.
0x00000005	Filter on year , month , day , hour , minute , and second fields.

2.5.5 AFDOper

The **AFDOper** structure specifies an [AutoFilter](#) data operation.

0	1	2	3	4	5	6	7	8	9	10	11	12	13	14	15	16	17	18	19	20	21	22	23	24	25	26	27	28	29	30	31
vt										grbitSign										vtValue											
...																															
...																															

vt (1 byte): An unsigned integer that specifies the type of comparison. MUST be a value as specified in the table listed under **vtValue**. If this structure is part of an [AutoFilter12](#) record, the value of **vt** MUST NOT be 0x02.

grbitSign (1 byte): An unsigned integer that specifies the comparison operation between a **cell value** and **vtValue**. MUST be one of the following values:

Value	Meaning
0x01	Cell value is displayed if it is less than the value specified in vtValue .
0x02	Cell value is displayed if it is equal to the value specified in vtValue .
0x03	Cell value is displayed if it is less than or equal to the value specified in vtValue .
0x04	Cell value is displayed if it is greater than the value specified in vtValue .
0x05	Cell value is displayed if it is not equal to the value specified in vtValue .
0x06	Cell value is displayed if it is greater than or equal to the value specified in vtValue .

If **vt** is equal to 0x00, this field is undefined and MUST be ignored.

vtValue (8 bytes): A variable type field whose type and meaning is dictated by the value of **vt**, as specified in the following table:

Value of vt	Meaning of vtValue
0x00	vtValue is 8 bytes which are undefined and MUST be ignored.
0x02	vtValue is an AFDOperRk that specifies a numeric value. MUST exist if and only if this structure is part of an AutoFilter record.
0x04	vtValue is an Xnum (section 2.5.342) that specifies a numeric value.
0x06	vtValue is an AFDOperStr that specifies a string value.
0x08	vtValue is an AFDOperBoolErr that specifies a Boolean or error value.
0x0C	All blanks are matched. vtValue is 8 bytes which are reserved, MUST be 0, and MUST be ignored.
0x0E	All non-blanks are matched. vtValue is 8 bytes which are reserved, MUST be 0, and MUST be ignored.

2.5.6 AFDOperBoolErr

The **AFDOperBoolErr** structure specifies a Boolean or error value for an [AutoFilter](#) comparison.

0	1	2	3	4	5	6	7	8	9	10	11	12	13	14	15	16	17	18	19	20	21	22	23	24	25	26	27	28	29	30	31
bes																unused1															
unused2																															

bes (2 bytes): A [Bes](#) that specifies the Boolean or error value.

unused1 (2 bytes): Undefined and MUST be ignored.

unused2 (4 bytes): Undefined and MUST be ignored.

2.5.7 AFDOperRk

The **AFDOperRk** structure specifies a numeric value for an [AutoFilter](#) comparison.

0	1	2	3	4	5	6	7	8	9	10	11	12	13	14	15	16	17	18	19	20	21	22	23	24	25	26	27	28	29	30	31
rk																															
unused1																															

rk (4 bytes): An [RkNumber](#) that specifies a numeric value.

unused1 (4 bytes): Undefined and MUST be ignored.

2.5.8 AFDOperStr

The **AFDOperStr** structure specifies a string value for an [AutoFilter](#) comparison. The string location is specified by the record or structure that contains this structure.

A question mark character ('?') in the string specifies a matching condition on any single character. An asterisk character ('*') in the string specifies a matching condition on a sequence of zero or more characters.

0	1	2	3	4	5	6	7	8	9	10	11	12	13	14	15	16	17	18	19	20	21	22	23	24	25	26	27	28	29	30	31
unused1 (optional)																															
cch								fCompare								reserved1								unused2							
unused3 (optional)																															

unused1 (4 bytes): Undefined and MUST be ignored. MUST exist if and only if this structure is part of an [AutoFilter](#), a [Feature11](#) or a [Feature12](#) record.

cch (1 byte): An unsigned integer that specifies the number of characters in the string. MUST be greater than or equal to 1.

fCompare (1 byte): A Boolean (section [2.5.14](#)) that specifies whether the string comparison contains question mark or asterisk characters. MUST be a value from the following table:

Value	Meaning
0	String comparison contains question mark or asterisk characters.
1	String comparison does not contain question mark or asterisk characters.

reserved1 (1 byte): MUST be zero, and MUST be ignored.

unused2 (1 byte): Undefined and MUST be ignored.

unused3 (4 bytes): Undefined and MUST be ignored. MUST exist if and only if this structure is part of an [AutoFilter12](#).

2.5.9 AutoFmt8

The **AutoFmt8** enumeration specifies the following auto formatting styles<[149](#)>.

Name	Value	Meaning
XL8_ITBLSIMPLE	0x0000	Simple
XL8_ITBLCLASSIC1	0x0001	Classic 1
XL8_ITBLCLASSIC2	0x0002	Classic 2
XL8_ITBLCLASSIC3	0x0003	Classic 3
XL8_ITBLACCOUNTING1	0x0004	Accounting 1
XL8_ITBLACCOUNTING2	0x0005	Accounting 2
XL8_ITBLACCOUNTING3	0x0006	Accounting 3
XL8_ITBLACCOUNTING4	0x0007	Accounting 4
XL8_ITBLCOLORFUL1	0x0008	Colorful 1
XL8_ITBLCOLORFUL2	0x0009	Colorful 2
XL8_ITBLCOLORFUL3	0x000A	Colorful 3
XL8_ITBLLIST1	0x000B	List 1
XL8_ITBLLIST2	0x000C	List 2
XL8_ITBLLIST3	0x000D	List 3
XL8_ITBL3DEFFECTS1	0x000E	3Deffects 1
XL8_ITBL3DEFFECTS2	0x000F	3Deffects 2
XL8_ITBLNONE_GEN	0x0010	None
XL8_ITBLJAPAN2	0x0011	Japan 2
XL8_ITBLJAPAN3	0x0012	Japan 3
XL8_ITBLJAPAN4	0x0013	Japan 4
XL8_ITBLNONE_JPN	0x0014	Japan None
XL8_ITBLREPORT1	0x1000	Report 1
XL8_ITBLREPORT2	0x1001	Report 2
XL8_ITBLREPORT3	0x1002	Report 3
XL8_ITBLREPORT4	0x1003	Report 4
XL8_ITBLREPORT5	0x1004	Report 5
XL8_ITBLREPORT6	0x1005	Report 6

Name	Value	Meaning
XL8_ITBLREPORT7	0x1006	Report 7
XL8_ITBLREPORT8	0x1007	Report 8
XL8_ITBLREPORT9	0x1008	Report 9
XL8_ITBLREPORT10	0x1009	Report 10
XL8_ITBLTABLE1	0x100A	Table 1
XL8_ITBLTABLE2	0x100B	Table 2
XL8_ITBLTABLE3	0x100C	Table 3
XL8_ITBLTABLE4	0x100D	Table 4
XL8_ITBLTABLE5	0x100E	Table 5
XL8_ITBLTABLE6	0x100F	Table 6
XL8_ITBLTABLE7	0x1010	Table 7
XL8_ITBLTABLE8	0x1011	Table 8
XL8_ITBLTABLE9	0x1012	Table 9
XL8_ITBLTABLE10	0x1013	Table 10
XL8_ITBLPTCLASSIC	0x1014	Table PTClassic
XL8_ITBLPTNONE	0x1015	None

2.5.10 Bes

The **Bes** structure specifies either a Boolean (section [2.5.14](#)) value or an error value. **bBoolErr** specifies the value and **fError** specifies the value's type.

0	1	2	3	4	5	6	7	8	9	10	11	12	13	14	15	16	17	18	19	20	21	22	23	24	25	26	27	28	29	30	31
bBoolErr										fError																					

bBoolErr (1 byte): An unsigned integer that specifies either a Boolean value or an error value, depending on the value of **fError**.

A Boolean value MUST be a value from the following table:

Value	Meaning
0x00	False
0x01	True

An error value MUST be a value from the following table:

Value	Meaning
0x00	#NULL!
0x07	#DIV/0!
0x0F	#VALUE!

Value	Meaning
0x17	#REF!
0x1D	#NAME?
0x24	#NUM!
0x2A	#N/A
0x2B	#GETTING_DATA

fError (1 byte): A Boolean that specifies whether **bBoolErr** contains an error code or a Boolean value. MUST be a value from the following table:

Value	Meaning
0x00	bBoolErr SHOULD <150> contain a Boolean value.
0x01	bBoolErr contains an error value.

2.5.11 Bold

The **Bold** enumeration specifies the **font face weight**.

Name	Value	Meaning
BLSNORMAL	0x0190	Normal font weight
BLSBOLD	0x02BC	Bold font weight

2.5.12 BookExt_Conditional11

The **BookExt_Conditional11** structure specifies two properties of a **workbook**.

0	1	2	3	4	5	6	7	8	9	10	11	12	13	14	15	16	17	18	19	20	21	22	23	24	25	26	27	28	29	30	31
A	B	unused																													

A - fBuggedUserAboutSolution (1 bit): A bit that specifies whether a warning is requested before loading a **manifest** that is a **smart document**.

B - fShowInkAnnotation (1 bit): A bit that specifies whether **ink comments** are visible in this workbook.

unused (6 bits): Undefined and MUST be ignored.

2.5.13 BookExt_Conditional12

The **BookExt_Conditional12** structure specifies **workbook** related information.

0	1	2	3	4	5	6	7	8	9	10	11	12	13	14	15	16	17	18	19	20	21	22	23	24	25	26	27	28	29	30	31
A	B	C	reserved2																												

A - reserved1 (1 bit): MUST be zero, and MUST be ignored.

B - fPublishedBookItems (1 bit): A bit that specifies whether only specific **selected** items, including **defined names, tables, chart** object and [PivotTables](#), are shown when the workbook is published to a server.

Value	Meaning
0	All sheets or selected sheets are published. Each sheet is published, unless the SheetExt record for the sheet exists and the fNotPublished field of the SheetExtOptional structure of the SheetExt record is 1.
1	Only selected items are published. For each item, the fPublished field in the record or structure within the record that specifies the item determines whether the item is published. For each type of item, the records and structures that contain the fPublished flag are as follows: Chart object: FtCmo structure of the Obj record Table: TableFeatureType structure of the Feature11 record Defined name: Lbj record Defined name: NamePublish record PivotTable : SXAddl SXCView SXDVer12Info record

C - fShowPivotChartFilter (1 bit): A bit that specifies whether to show the **PivotChart filter pane**.

reserved2 (5 bits): MUST be zero, and MUST be ignored.

2.5.14 Boolean

An unsigned integer greater than 1 bit in size that specifies a Boolean value. MUST be a value from the following table. All other bits in the field MUST be 0.

Value	Meaning
0x0	Boolean value FALSE
0x1	Boolean value TRUE

2.5.15 BorderStyle

The **BorderStyle** enumeration specifies the border line **style**.

Name	Value	Meaning
NONE	0x0000	No border
THIN	0x0001	Thin line
MEDIUM	0x0002	Medium line
DASHED	0x0003	Dashed line
DOTTED	0x0004	Dotted line
THICK	0x0005	Thick line
DOUBLE	0x0006	Double line

Name	Value	Meaning
HAIR	0x0007	Hairline
MEDIUMDASHED	0x0008	Medium dashed line
DASHDOT	0x0009	Dash-dot line
MEDIUMDASHDOT	0x000A	Medium dash-dot line
DASHDOTDOT	0x000B	Dash-dot-dot line
MEDIUMDASHDOTDOT	0x000C	Medium dash-dot-dot line
SLANTDASHDOT	0x000D	Slanted dash-dot-dot line

2.5.16 BuiltInStyle

The **BuiltInStyle** structure specifies the type of a built-in [cell style](#). For **row outline** and **column outline** types this structure also specifies the **outline level** of the **style**.

0	1	2	3	4	5	6	7	8	9	10	11	12	13	14	15	16	17	18	19	20	21	22	23	24	25	26	27	28	29	30	31
istyBuiltIn										iLevel																					

istyBuiltIn (1 byte): An unsigned integer that specifies the type of the built-in cell style. SHOULD be a value from the list of built in cell styles specified in [\[ECMA-376\]](#) Part 4: Markup Language Reference, section 3.8.7. [<151>](#)

iLevel (1 byte): An unsigned integer that specifies the depth level of row/column automatic outlining. If **istyBuiltIn** equals 0x01 or 0x02, this value MUST be one of the following:

Value	Meaning
0x00	Outline level is 1
0x01	Outline level is 2
0x02	Outline level is 3
0x03	Outline level is 4
0x04	Outline level is 5
0x05	Outline level is 6
0x06	Outline level is 7

Otherwise, this value MUST be 0xFF and MUST be ignored.

2.5.17 CachedDiskHeader

The **CachedDiskHeader** structure specifies the formatting information of a **table** column heading.

0	1	2	3	4	5	6	7	8	9	10	11	12	13	14	15	16	17	18	19	20	21	22	23	24	25	26	27	28	29	30	31
cbdxHdrDisk																															
rgHdrDisk (variable)																															
...																															

strStyleName (variable)
...

cbdxHdrDisk (4 bytes): An unsigned integer that specifies the size, in bytes, of the **rgHdrDisk** field.

rgHdrDisk (variable): A [DXFN12List](#) structure that specifies the formatting of the column heading.

strStyleName (variable): An [XLUnicodeString](#) that specifies the name of the **style** to use for the column heading. The name of the style MUST equal the **user** field of a [Style](#) record in the [Globals Substream ABNF](#), or the name of a built-in style, as specified by the [BuiltInStyle](#) record. This field is present only if the **fSaveStyleName** field of the containing [Feat11FieldDataItem](#) structure is set to 0x1.

If present, the formatting as specified by **strStyleName** is applied first, before the formatting as specified by **rgHdrDisk** is applied.

2.5.18 Cch255

A 2 byte unsigned integer that specifies a string size in characters.

The value 0xFFFF specifies that the string is NULL.

The value MUST be 0xFFFF or less than or equal to 0x00FF.

2.5.19 Cell

The **Cell** structure specifies a **cell** in the current **sheet**.

0	1	2	3	4	5	6	7	8	9	10	11	12	13	14	15	16	17	18	19	20	1	2	3	4	5	6	7	8	9	30	1
rw																col															
ixfe																															

rw (2 bytes): An [Rw](#) that specifies the row.

col (2 bytes): A [Col](#) that specifies the column.

ixfe (2 bytes): An [IXFCell](#) that specifies the [XF](#) record.

2.5.20 CellXF

This structure specifies formatting properties for a **cell**.

0	1	2	3	4	5	6	7	8	9	10	11	12	13	14	15	16	17	18	19	20	1	2	3	4	5	6	7	8	9	30	1
alc		A	alcV		B	trot						cIndent		C	D	E	F	G	H	I	J	K	L								
dgLeft			dgRight			dgTop			M	icvLeft			icvRight			N															

icvTop	icvBottom	icvDiag		dgDiag	O	fls
icvFore	icvBack	P	Q			

alc (3 bits): A [HorizAlign](#) that specifies the **horizontal alignment**.

A - fWrap (1 bit): A bit that specifies whether the cell text is wrapped.

alcV (3 bits): A [VertAlign](#) that specifies the **vertical alignment**.

B - fJustLast (1 bit): A bit that specifies whether the justified or distributed alignment of the cell is used on the last line of text (setting this to 1 is typical for East Asian text but not typical in other contexts). If this field equals 1, then **alc** MUST equal 7.

trot (1 byte): An [XFPropTextRotation](#) that specifies the text rotation.

cIndent (4 bits): An unsigned integer that specifies the text **indentation level**. MUST be less than or equal to 15.

C - fShrinkToFit (1 bit): A bit that specifies whether the cell is **shrink to fit**.

D - reserved1 (1 bit): MUST be 0, and MUST be ignored.

E - iReadOrder (2 bits): A [ReadingOrder](#) that specifies the **reading order**.

F - reserved2 (2 bits): MUST be 0, and MUST be ignored.

G - fAtrNum (1 bit): A bit that specifies that if the **ifmt** field of the [XF](#) record specified by the **ixfParent** field of the containing XF record is updated, the corresponding field of the containing XF record will not be set to the same value. MUST be a value from the following table:

Value	Meaning
0x0	The ifmt field of the containing XF record is updated when the corresponding field of the XF record specified by the ixfParent field of the containing XF record is changed.
0x1	The ifmt field of the containing XF record is not updated when the corresponding field of the XF record specified by the ixfParent field of the containing XF record is changed.

H - fAtrFnt (1 bit): A bit that specifies that if the **ifnt** field of the XF record specified by the **ixfParent** field of the containing XF record is updated, the corresponding field of the containing XF record will not be set to the same value. MUST be a value from the following table:

Value	Meaning
0x0	The ifnt field of the containing XF record is updated when the corresponding field of the XF record specified by the ixfParent field of the containing XF record is changed.
0x1	The ifnt field of the containing XF record is not updated when the corresponding field of the XF record specified by the ixfParent field of the containing XF record is changed.

I - fAtrAlc (1 bit): A bit that specifies that if the **alc** field, or the **fWrap** field, or the **alcV** field, or the **fJustLast** field, or the **trot** field, or the **cIndent** field, or the **fShrinkToFit** field or the **iReadOrder** field of the XF record specified by the **ixfParent** field of the containing XF record is updated, the corresponding fields of this structure will not be set to the same values. MUST be a value from the following table:

Value	Meaning
0x0	The alc , fWrap , alcV , fJustLast , trot , cIndent , fShrinkToFit , iReadOrder fields are updated when the corresponding fields of the XF record specified by the ixfParent field of the containing XF record are changed.
0x1	The alc , fWrap , alcV , fJustLast , trot , cIndent , fShrinkToFit , iReadOrder fields are not updated when the corresponding fields of the XF record specified by the ixfParent field of the containing XF record are changed.

J - fAtrBdr (1 bit): A bit that specifies that if the **dgLeft** field, or the **dgRight** field, or the **dgTop** field, or the **dgBottom** field, or the **dgDiag** field, or the **icvLeft** field, or the **icvRight** field, or the **grbitDiag** field, or the **icvTop** field, or the **icvBottom** field, or the **icvDiag** field of the XF record specified by the **ixfParent** field of the containing XF record is updated, the corresponding fields of this structure will not be set to the same values. MUST be a value from the following table:

Value	Meaning
0x0	The dgLeft , dgRight , dgTop , dgBottom , dgDiag , icvLeft , icvRight , grbitDiag , icvTop , icvBottom , icvDiag fields are updated when the corresponding fields of the XF record specified by the ixfParent field of the containing XF record are changed.
0x1	The dgLeft , dgRight , dgTop , dgBottom , dgDiag , icvLeft , icvRight , grbitDiag , icvTop , icvBottom , icvDiag fields are not updated when the corresponding fields of the XF record specified by the ixfParent field of the containing XF record are changed.

K - fAtrPat (1 bit): A bit that specifies that if the **fls** field, the **icvFore** field, or the **icvBack** field of the XF record specified by the **ixfParent** field of the containing XF record is updated, the corresponding fields of this structure will not be set to the same values. MUST be a value from the following table:

Value	Meaning
0x0	The fls , icvFore , and icvBack fields are updated when the corresponding fields of the XF record specified by the ixfParent field of the containing XF record are changed.
0x1	The fls , icvFore , and icvBack fields are not updated when the corresponding fields of the XF record specified by the ixfParent field of the containing XF record are changed.

L - fAtrProt (1 bit): A bit that specifies that if the **fLocked** field or the **fHidden** field of the XF record specified by the **ixfParent** field of the containing XF record is updated, the corresponding fields of the containing XF record will not be set to the same values. MUST be a value from the following table:

Value	Meaning
0x0	The fLocked and fHidden fields of the containing XF record are updated when the corresponding fields of the XF record specified by the ixfParent field of the containing XF record are changed.
0x1	The fLocked and fHidden fields of the containing XF record are not updated when the corresponding fields of the XF record specified by the ixfParent field of the containing XF record are changed.

dgLeft (4 bits): A [BorderStyle](#) that specifies the **logical left border formatting**.

dgRight (4 bits): A [BorderStyle](#) that specifies the **logical right** border formatting.

dgTop (4 bits): A [BorderStyle](#) that specifies the top border formatting.

M - dgBottom (4 bits): A [BorderStyle](#) that specifies the bottom border formatting.

icvLeft (7 bits): An unsigned integer that specifies the color of the logical left **border**. The value MUST be one of the values specified in [IcvXF](#) or 0. A value of 0 means the logical left border color has not been specified. If this value is 0, then **dgLeft** MUST also be 0.

icvRight (7 bits): An unsigned integer that specifies the color of the logical right border. The value MUST be one of the values specified in [IcvXF](#) or 0. A value of 0 means the logical right border color has not been specified. If this value is 0, then **dgRight** MUST also be 0.

N - grbitDiag (2 bits): An unsigned integer that specifies which diagonal borders are present (if any). MUST be a value from the following table:

Value	Meaning
0x0	No diagonal border
0x1	Diagonal-down border
0x2	Diagonal-up border
0x3	Both diagonal-down and diagonal-up

icvTop (7 bits): An unsigned integer that specifies the color of the top border. The value MUST be one of the values specified in [IcvXF](#) or 0. A value of 0 means the top border color has not been specified. If this value is 0, then **dgTop** MUST also be 0.

icvBottom (7 bits): An unsigned integer that specifies the color of the bottom border. The value MUST be one of the values specified in [IcvXF](#) or 0. A value of 0 means the bottom border color has not been specified. If this value is 0 then **dgBottom** MUST also be 0.

icvDiag (7 bits): An unsigned integer that specifies the color of the diagonal border. The value MUST be one of the values specified in [IcvXF](#) or 0. A value of 0 means the diagonal border color has not been specified. If this value is 0 then **dgDiag** MUST also be 0.

dgDiag (4 bits): A [BorderStyle](#) that specifies the diagonal border formatting.

O - fHasXFExt (1 bit): A bit that specifies whether an [XFExt](#) will extend the information in this XF.

fls (6 bits): A [FillPattern](#) that specifies the **fill pattern**. If this value is 1, which specifies a solid fill pattern, then only **icvFore** is rendered.

icvFore (7 bits): An IcvXF that specifies the **foreground color** of the fill pattern.

icvBack (7 bits): An unsigned integer that specifies the **background color** of the fill pattern. The value SHOULD [<152>](#) be an IcvXF value.

P - fsxButton (1 bit): A bit that specifies whether the XF record is attached to a pivot field drop-down button.

Q - reserved3 (1 bit): MUST be 0 and MUST be ignored.

2.5.21 CFColor

The **CFColor** structure specifies a color in **conditional formatting** records or in a [SheetExt](#) record.

0	1	2	3	4	5	6	7	8	9	10	11	12	13	14	15	16	17	18	19	20	21	22	23	24	25	26	27	28	29	30	31
xclrType																															
xclrValue																															
numTint																															
...																															

xclrType (4 bytes): An [XColorType](#) that specifies the type of color reference. MUST be different from XCLRINCHED. MUST be different from XCLRAUTO unless it is contained in a SheetExt record.

xclrValue (4 bytes): A structure that specifies the color value. The type of structure depends on the color reference type specified by **xclrType** and MUST be a structure from the following table:

Value of xclrType	Type
XCLRAUTO	Ignored
XCLRINDEXED	ColorICV
XCLRRGB	LongRGBA<153>
XCLRTHEMED	ColorTheme

numTint (8 bytes): An Xnum (section [2.5.342](#)) that specifies the tint and **shade** value to be applied to the color. MUST be greater than or equal to -1.0 and less than or equal to 1.0

2.5.22 CFDatabar

The **CFDatabar** structure specifies the parameters of a **conditional formatting** rule that uses **data bar** formatting.

0	1	2	3	4	5	6	7	8	9	10	11	12	13	14	15	16	17	18	19	20	21	22	23	24	25	26	27	28	29	30	31
unused																reserved1						A	B	reserved2							

iPercentMin	iPercentMax	color (16 bytes)
...		
...		
...	cfvoDB1 (variable)	
...		
cfvoDB2 (variable)		
...		

unused (2 bytes): Undefined and MUST be ignored.

reserved1 (1 byte): MUST be zero and MUST be ignored.

A - fRightToLeft (1 bit): A bit that specifies whether the data bars are drawn starting from the right of the **cell**. MUST be a value from the following table:

Value	Meaning
0x0	Data bars are drawn starting from the left of the cell
0x1	Data bars are drawn starting from the right of the cell

B - fShowValue (1 bit): A bit that specifies whether the numerical value of the cell appears in the cell along with the data bar.

reserved2 (6 bits): MUST be zero and MUST be ignored.

iPercentMin (1 byte): An unsigned integer that specifies the length of a data bar, as a percentage of the cell width, that is applied to cells with values equal to the [CFVO](#) value specified by **cfvoDB1**. MUST be less than or equal to 100.

iPercentMax (1 byte): An unsigned integer that specifies the length of a data bar, as a percentage of the cell width, that is applied to cells with values equal to the CFVO value specified by **cfvoDB2**. MUST be greater than **iPercentMin** and less than or equal to 100.

color (16 bytes): A [CFCOLOR](#) structure that specifies the color of the data bar.

cfvoDB1 (variable): A CFVO that specifies the maximum **cell value** that will be represented with a minimum width data bar. All cell values that are less than or equal to the CFVO value specified by this field are represented with a data bar of **iPercentMin** percent of the cell width.

cfvoDB2 (variable): A CFVO that specifies the minimum cell value that will be represented with a maximum width data bar. All cell values that are greater than or equal to the CFVO value specified by this field are represented with a data bar of **iPercentMax** percent of the cell width.

2.5.23 CFExAveragesTemplateParams

This structure specifies the parameters for an above or below average **conditional formatting** rule in a containing [CF12](#) record or [CFExNonCF12](#) structure.

0	1	2	3	4	5	6	7	8	9	10	11	12	13	14	15	16	17	18	19	20	21	22	23	24	25	26	27	28	29	30	31
iParam											reserved (14 bytes)																				
...																															
...																															
...																															

iParam (2 bytes): An unsigned integer that specifies the number of standard deviations above or below the average for the rule. MUST be a value from the following table:

Value	Meaning
0x0000	The threshold is not offset by a multiple of the standard deviation.
0x0001	The threshold is offset by 1 standard deviation.
0x0002	The threshold is offset by 2 standard deviations.

reserved (14 bytes): MUST be zero and MUST be ignored.

2.5.24 CFExDateTemplateParams

The **CFExDateTemplateParams** structure specifies parameters for the date-related **conditional formatting** rules specified by a [CF12](#) record or [CFExNonCF12](#) structure.

0	1	2	3	4	5	6	7	8	9	10	11	12	13	14	15	16	17	18	19	20	21	22	23	24	25	26	27	28	29	30	31
dateOp											reserved (14 bytes)																				
...																															
...																															
...																															

dateOp (2 bytes): An unsigned integer that specifies the type of date comparison. The value of this field MUST be equal to the value that corresponds to the **icfTemplate** field in the containing CF12 record or CFExNonCF12 structure, according to the following table:

Value of icfTemplate	Value of this field
----------------------	---------------------

Value of icfTemplate	Value of this field
15	0
16	6
17	1
18	2
19	5
20	8
21	3
22	7
23	4
24	9

reserved (14 bytes): MUST be zero and MUST be ignored.

2.5.25 CFExDefaultTemplateParams

This structure specifies that there are no parameters for extensions to **conditional formatting** rules specified by [CFEx](#).

0	1	2	3	4	5	6	7	8	9	10	11	12	13	14	15	16	17	18	19	20	21	22	23	24	25	26	27	28	29	30	31
unused (16 bytes)																															
...																															
...																															

unused (16 bytes): Undefined and MUST be ignored.

2.5.26 CFExFilterParams

The **CFExFilterParams** structure specifies parameters for a **conditional formatting** rule of type **filter**.

0	1	2	3	4	5	6	7	8	9	10	11	12	13	14	15	16	17	18	19	20	21	22	23	24	25	26	27	28	29	30	31
A	B	reserved1						iParam														reserved2 (13 bytes)									
...																															
...																															
...																															

A - fTop (1 bit): A bit that specifies whether the top or bottom items are displayed with the conditional formatting. MUST be one of the following values:

Value	Meaning
-------	---------

Value	Meaning
0x0	Bottom items are displayed with the conditional formatting
0x1	Top items are displayed with the conditional formatting

B - fPercent (1 bit): A bit that specifies whether a percentage of the top or bottom items are displayed with the conditional formatting, or whether a set number of the top or bottom items are displayed with the conditional formatting. MUST be one of the following values:

Value	Meaning
0x0	A set number of top or bottom items, specified by iParam , are displayed with the conditional formatting.
0x1	A percentage of top or bottom items, specified by iParam , are displayed with the conditional formatting

reserved1 (6 bits): MUST be zero and MUST be ignored.

iParam (2 bytes): An unsigned integer that specifies how many values are displayed with the conditional formatting. If **fPercent** equals 1 then this field represents a percent and MUST be less than or equal to 100. Otherwise, this field represents a set number of **cells** and MUST be less than or equal to 1000.

reserved2 (13 bytes): MUST be zero and MUST be ignored.

2.5.27 CFExNonCF12

The **CFExNonCF12** structure specifies properties that extend a **conditional formatting** rule that is specified by a **CF** record.

0	1	2	3	4	5	6	7	8	9	10	11	12	13	14	15	16	17	18	19	20	21	22	23	24	25	26	27	28	29	30	31
icf												cp					icfTemplate														
ipriority												A	B	C	D	E					fHasDXF										
dxfl (variable)																															
...																															
cbTemplateParm										rgbTemplateParms (16 bytes)																					
...																															
...																															
...																															

icf (2 bytes): An unsigned integer that specifies a zero-based index of a CF record in the collection of CF records directly following the **CondFmt** record that is referenced by the parent **CFEx** record with the **nID** field. The referenced CF specifies the conditional formatting rule to be extended.

cp (1 byte): An unsigned integer that specifies the type of comparison operation to use when the **ct** field of the CF record referenced by the **icf** field of this structure is equal to 0x01. MUST be zero when the **ct** field of the CF record is not equal to 1. SHOULD [<154>](#) be equal to the **cp** field in the referenced CF record.

In the following table, *v* represents the **cell** value, and *v1* and *v2* represent the results of evaluating the formulas specified by **rgce1** and **rgce2** fields of the referenced CF record specified by **icf**. The value of this field MUST be a value from the following table:

Value	Comparison Operation
0x00	No comparison
0x01	<i>v2</i> is greater than or equal to <i>v1</i> , and <i>v</i> is greater than or equal to <i>v1</i> and less than or equal to <i>v2</i> -Or- <i>v1</i> is greater than <i>v2</i> , and <i>v</i> is greater than or equal to <i>v2</i> and less than or equal to <i>v1</i>
0x02	<i>v2</i> is greater than or equal to <i>v1</i> , and <i>v</i> is less than <i>v1</i> or greater than <i>v2</i> -Or- <i>v1</i> is greater than <i>v2</i> , and <i>v</i> is less than <i>v2</i> or greater than <i>v1</i>
0x03	<i>v</i> is equal to <i>v1</i>
0x04	<i>v</i> is not equal to <i>v1</i>
0x05	<i>v</i> is greater than <i>v1</i>
0x06	<i>v</i> is less than <i>v1</i>
0x07	<i>v</i> is greater than or equal to <i>v1</i>
0x08	<i>v</i> is less than or equal to <i>v1</i>

icfTemplate (1 byte): An unsigned integer that specifies the template from which the rule was created. MUST be the least significant byte of one of the valid values specified for the **icfTemplate** field in the [CF12](#) record.

ipriority (2 bytes): An unsigned integer that specifies the priority of the rule. Rules that apply to the same cell are evaluated in increasing order of **ipriority**. MUST be unique across all CF12 records and CFExNonCF12 structures in the [worksheet](#) substream.

A - fActive (1 bit): A bit that specifies whether the rule is active. If set to zero, the rule will be ignored.

B - fStopIfTrue (1 bit): A bit that specifies whether, when a cell fulfills the condition corresponding to this rule, the lower priority conditional formatting rules that apply to this cell are evaluated. MUST be one of the following values:

Value	Meaning
0x0	Evaluate lower priority conditional formatting rules that apply to this cell
0x1	If the cell fulfills the condition corresponding to this rule, do not evaluate lower priority conditional formatting rules that apply to this cell

C - reserved1 (1 bit): MUST be zero and MUST be ignored.

D - unused (1 bit): Undefined and MUST be ignored.

E - reserved2 (4 bits): MUST be zero and MUST be ignored.

fHasDXF (1 byte): A Boolean (section [2.5.14](#)) that specifies whether cell formatting data is part of this record extension. MUST be a value from the following table:

Value	Meaning
0x00	No formatting data in this record extension.
0x01	Formatting data is part of this record extension.

dxfl (variable): A [DXFN12](#) structure that specifies the format to use for cells that satisfy the condition. MUST NOT be present when **fHasDXF** is zero.

cbTemplateParm (1 byte): An unsigned integer that specifies the size of the **rgbTemplateParms** field in bytes. MUST be equal to 16.

rgbTemplateParms (16 bytes): A [CFExTemplateParams](#) that specifies parameters for the rule specified by this structure.

2.5.28 CFExTemplateParams

The **CFExTemplateParams** structure specifies parameters for **conditional formatting** rules of type [CF12](#) or [CFExNonCF12](#). The type of this structure depends on the **icfTemplate** field in the containing structure as specified in the following table:

Value of icfTemplate	Type of CFExTemplateParams
0x05	CFExFilterParams
0x08	CFExTextTemplateParams
0x0F	CFExDateTemplateParams
0x10	CFExDateTemplateParams
0x11	CFExDateTemplateParams
0x12	CFExDateTemplateParams
0x13	CFExDateTemplateParams
0x14	CFExDateTemplateParams
0x15	CFExDateTemplateParams
0x16	CFExDateTemplateParams
0x17	CFExDateTemplateParams
0x18	CFExDateTemplateParams
0x19	CFExAveragesTemplateParams
0x1A	CFExAveragesTemplateParams
0x1D	CFExAveragesTemplateParams

Value of icfTemplate	Type of CFExTemplateParams
0x1E	CFExAveragesTemplateParams
other	CFExDefaultTemplateParams

2.5.29 CFExTextTemplateParams

The **CFExTextTemplateParams** structure specifies parameters for text-related **conditional formatting** rules as specified by a [CF12](#) record or [CFExNonCF12](#) structure.

0	1	2	3	4	5	6	7	8	9	10	11	12	13	14	15	16	17	18	19	20	21	22	23	24	25	26	27	28	29	30	31
ctp																reserved (14 bytes)															
...																															
...																															
...																															

ctp (2 bytes): An unsigned integer that specifies the type of text rule. MUST be a value from the following table:

Value	Meaning
0x0000	Text contains
0x0001	Text does not contain
0x0002	Text begins with
0x0003	Text ends with

reserved (14 bytes): MUST be zero and MUST be ignored.

2.5.30 CFFilter

The **CFFilter** structure specifies the parameters of a **conditional formatting** rule of type **top N filter**.

0	1	2	3	4	5	6	7	8	9	10	11	12	13	14	15	16	17	18	19	20	21	22	23	24	25	26	27	28	29	30	31
cbFilter																reserved1						A	B	reserved2							
iParam																															

cbFilter (2 bytes): An unsigned integer that specifies the size of the structure in bytes, excluding the **cbFilter** field itself.

reserved1 (1 byte): MUST be zero and MUST be ignored.

A - fTop (1 bit): A bit that specifies whether the top or bottom items are displayed with the conditional formatting. MUST be one of the following values:

Value	Meaning
0x0	Bottom items are displayed with the conditional formatting
0x1	Top items are displayed with the conditional formatting

B - fPercent (1 bit): A bit that specifies whether a percentage of top or bottom items are displayed with the conditional formatting, or a set number of top or bottom items are displayed with the conditional formatting. MUST be one of the following values:

Value	Meaning
0x0	Top or bottom iParam items are displayed with the conditional formatting.
0x1	Top or bottom iParam percent of items are displayed with the conditional formatting

reserved2 (6 bits): MUST be zero and MUST be ignored.

iParam (2 bytes): An unsigned integer that specifies how many values are displayed with the conditional formatting. If **fPercent** is set to 1 then this field represents a percent and MUST be less than or equal to 100, otherwise this field is a number of **cells** and MUST be less than or equal to 1000.

2.5.31 CFFlag

The **CFFlag** structure specifies the conditional format flag information.

0	1	2	3	4	5	6	7	8	9	10	11	12	13	14	15	16	17	18	19	20	21	22	23	24	25	26	27	28	29	30	31
iIconSet																															
iIcon																															

iIconSet (4 bytes): A [kPISets](#) that identifies an **icon set**.

iIcon (4 bytes): A signed integer that specifies an **icon** in the set. The value of this field changes the **sort order** for custom sorts that are based on icon sets.

MUST be a value from the following table:

Value	Meaning
-1	No icon
0	First icon in the icon set
1	Second icon in the icon set
2	Third icon in the icon set
3	Fourth icon in the icon set
4	Fifth icon in the icon set

2.5.32 CFGradient

The **CFGradient** structure specifies the parameters of a **conditional formatting** rule that uses **color scale** formatting. Color scale formatting maps **cell** values to colors through the following process:

1. An interpolation curve maps cell values to values between 0 and 1. The first and last control points, as specified in **rgInterp**, specify the cell values that map to 0 and 1 respectively.
2. A gradient curve maps values between 0 and 1 to colors.

Both curves are determined by two or three control points, with linear interpolation between those points.

0	1	2	3	4	5	6	7	8	9	10	11	12	13	14	15	16	17	18	19	20	21	22	23	24	25	26	27	28	29	30	31
unused										reserved1										cInterpCurve											
cGradientCurve						A	B	reserved2						rgInterp (variable)																	
...																															
rgCurve (variable)																															
...																															

unused (2 bytes): Undefined and MUST be ignored.

reserved1 (1 byte): MUST be zero and MUST be ignored.

cInterpCurve (1 byte): An unsigned integer that specifies the number of control points in the interpolation curve. It MUST be 0x2 or 0x3.

cGradientCurve (1 byte): An unsigned integer that specifies the number of control points in the gradient curve. It MUST be equal to **cInterpCurve**.

A - fClamp (1 bit): A bit that specifies that the cell values are not used when they are out of the **range** of the interpolation curve. The minimum or the maximum of the interpolation curve is used instead of the cell value. The value SHOULD [<155>](#) be 1.

B - fBackground (1 bit): A bit that specifies that the color scale formatting applies to the background of the cells. It MUST be 1.

reserved2 (6 bits): MUST be zero and MUST be ignored.

rgInterp (variable): An array of [CFGradientInterpItem](#). Each element is a control point of the interpolation curve. Its element count MUST be **cInterpCurve**.

rgCurve (variable): An array of [CFGradientItem](#). Each element is a control point of the gradient curve. Its element count MUST be **cGradientCurve**.

2.5.33 CFGradientInterpItem

The **CFGradientInterpItem** structure specifies one control point in the interpolation curve. The interpolation curve maps **cell values** to colors for a **conditional formatting** rule using **color scale**

formatting. The color is specified as the numerical value associated with the color in the corresponding **CFGradient.rgbCurve** array of the containing [CFGradient](#) structure.

0	1	2	3	4	5	6	7	8	9	10	1	2	3	4	5	6	7	8	9	20	1	2	3	4	5	6	7	8	9	30	1
cfvoInterp (variable)																															
...																															
numDomain																															
...																															

cfvoInterp (variable): A [CFVO](#) structure that specifies the cell value associated with the numerical value specified in **numDomain**.

numDomain (8 bytes): An Xnum (section [2.5.342](#)) structure that specifies the numerical value of this control point. MUST be equal to 0.0 if the structure is the first item in the **rgbCT.rgbInterp** array of the containing [CF12](#) record. MUST be equal to 1.0 if this structure is the last item in the **rgbCT.rgbInterp** array of the containing CF12 record. MUST be equal to 0.5 if this structure is the second item in the **rgbCT.rgbInterp** array of the containing CF12 record and **rgbCT.cInterpCurve** field of the containing CF12 record is equal to 0x03.

2.5.34 CFGradientItem

The **CFGradientItem** structure specifies one control point in the gradient curve. The gradient curve specifies a **color scale** used in **conditional formatting** and maps numerical values to colors.

0	1	2	3	4	5	6	7	8	9	10	1	2	3	4	5	6	7	8	9	20	1	2	3	4	5	6	7	8	9	30	1
numGrange																															
...																															
color (16 bytes)																															
...																															
...																															

numGrange (8 bytes): An Xnum (section [2.5.342](#)) that specifies the numerical value of the control point. MUST be equal to 0.0 if this structure is the first element in the **rgbCT.rgbCurve** array of the containing [CF12](#) record. MUST be equal to 1.0 if this structure is the last element in the **rgbCT.rgbCurve** array of the containing CF12 record. MUST be equal to 0.5 if this structure is the second element in the **rgbCT.rgbCurve** array of the containing CF12 record and the **rgbCT.cInterpCurve** field of the containing CF12 record is equal to 0x03.

color (16 bytes): A [CFColor](#) that specifies the color associated with the numerical value specified in **numGrange**.

2.5.35 CFMStateItem

The **CFMStateItem** structure specifies the threshold value associated with an **icon** for a **CFMultistate conditional formatting** rule.

0	1	2	3	4	5	6	7	8	9	10	11	12	13	14	15	16	17	18	19	20	21	22	23	24	25	26	27	28	29	30	31
cfvo (variable)																															
...																															
fEqual																unused															
...																															

cfvo (variable): A **CFVO** that specifies the threshold value.

fEqual (1 byte): A Boolean (section [2.5.14](#)) that MUST be a value from the following table:

Value	Meaning
0x00	Cell values that are equal to the threshold value do not pass the threshold
0x01	Cell values that are equal to the threshold value pass the threshold.

unused (4 bytes): Undefined and MUST be ignored.

2.5.36 CFMultistate

The **CFMultistate** structure specifies the parameters for a **conditional formatting** rule that represents **cell** values with icons from an **icon set**.

0	1	2	3	4	5	6	7	8	9	10	11	12	13	14	15	16	17	18	19	20	21	22	23	24	25	26	27	28	29	30	31			
unused																reserved1								cStates										
iIconSet										A	B	C	reserved3						rgStates (variable)															
...																																		

unused (2 bytes): Undefined and MUST be ignored.

reserved1 (1 byte): MUST be zero and MUST be ignored.

cStates (1 byte): An unsigned integer that specifies the number of items in the icon set. MUST be the value from the following table:

Value of iIconSet	Value of cStates
Between 0x00 and 0x07 included	0x03
Between 0x08 and 0x0C included	0x04
Between 0x0D and 0x10 included	0x05

iIconSet (1 byte): An unsigned integer that specifies the icon set that represents the cell values. MUST be the value from the following table:

Value	Meaning
0x00	
0x01	
0x02	
0x03	
0x04	
0x05	
0x06	
0x07	
0x08	
0x09	
0x0A	
0x0B	
0x0C	
0x0D	
0x0E	
0x0F	
0x10	

A - fIconOnly (1 bit): A bit that specifies whether only the **icon** will be displayed in the **sheet** and that the cell value will be **hidden**.

B - reserved2 (1 bit): MUST be zero and MUST be ignored.

C - fReverse (1 bit): A bit that specifies whether the order of the icons in the set is reversed.

reserved3 (5 bits): MUST be zero and MUST be ignored.

rgStates (variable): An array of [CFMStateItem](#). Each element specifies a threshold for the respective icon in the set, below which cell values are represented by the next icon in the set. The element count MUST be equal to **cStates**.

2.5.37 CFrtId

The **CFrtId** structure specifies a **range** of [Future Record Type](#) identifier values.

0	1	2	3	4	5	6	7	8	9	10	11	12	13	14	15	16	17	18	19	20	21	22	23	24	25	26	27	28	29	30	31
rtFirst																rtLast															

rtFirst (2 bytes): An unsigned integer that specifies the first Future Record Type in the range. The value **MUST** be less than or equal to **rtLast**.

rtLast (2 bytes): An unsigned integer that specifies the last Future Record Type in the range.

2.5.38 CFT

The **CFT** enumeration specifies **custom filter** types.

Name	Value	Meaning
CFTNIL	0x00000000	None
CFTTOP10	0x00000003	Top N filter
CFTEQUALDATE	0x00000004	Equal to date
CFTBEFORE	0x00000005	Before
CFTAFTER	0x00000006	After
CFTBETWEENDATE	0x00000007	Between dates
CFTTOMORROW	0x00000008	Tomorrow
CFTTODAY	0x00000009	Today
CFTYESTERDAY	0x0000000A	Yesterday
CFTNEXTWEEK	0x0000000B	Next week
CFTTHISWEEK	0x0000000C	This week
CFTLASTWEEK	0x0000000D	Last week
CFTNEXTMONTH	0x0000000E	Next month
CFTTHISMONTH	0x0000000F	This month
CFTLASTMONTH	0x00000010	Last month
CFTNEXTQUARTER	0x00000011	Next quarter
CFTTHISQUARTER	0x00000012	This quarter
CFTLASTQUARTER	0x00000013	Last quarter
CFTNEXTYEAR	0x00000014	Next year
CFTTHISYEAR	0x00000015	This year
CFTLASTYEAR	0x00000016	Last year
CFTYEARTODATE	0x00000017	Year to date
CFTQ1	0x00000018	First quarter
CFTQ2	0x00000019	Second quarter
CFTQ3	0x0000001A	Third quarter
CFTQ4	0x0000001B	Fourth quarter
CFTM1	0x0000001C	January

Name	Value	Meaning
CFTM2	0x0000001D	February
CFTM3	0x0000001E	March
CFTM4	0x0000001F	April
CFTM5	0x00000020	May
CFTM6	0x00000021	June
CFTM7	0x00000022	July
CFTM8	0x00000023	August
CFTM9	0x00000024	September
CFTM10	0x00000025	October
CFTM11	0x00000026	November
CFTM12	0x00000027	December
CFTNOTEQUALDATE	0x00000028	Does not equal date
CFTBEFOREOREQUAL	0x00000029	Equal or earlier date
CFTAFTEROREQUAL	0x0000002A	Equal or later date
CFTNOTBETWEENDATE	0x0000002B	Not between two dates

2.5.39 CFVO

The **CFVO** structure specifies a Conditional Formatting Value Object (CFVO) that specifies how to calculate a value from the **range** of cells that a **conditional formatting** rule applies to.

The value this structure specifies how to calculate is referred to as a CFVO value in other records.

0	1	2	3	4	5	6	7	8	9	10	11	12	13	14	15	16	17	18	19	20	21	22	23	24	25	26	27	28	29	30	31					
cfvoType										fmla (variable)																										
...																																				
numValue (optional)																																				
...																																				

cfvoType (1 byte): An unsigned integer that specifies how the CFVO value is determined. In the following table, X represents a parameter value. If **fmla.cce** is greater than zero, then X is the result of evaluating **fmla**, otherwise, X is **numValue**. **cfvoType** MUST be one of the following values:

Value	Meaning of CFVO Value
0x01	X
0x02	The minimum value from the range of cells that the conditional formatting rule applies to.

Value	Meaning of CFVO Value
0x03	The maximum value from the range of cells that the conditional formatting rule applies to.
0x04	The minimum value in the range of cells that the conditional formatting rule applies to plus X percent of the difference between the maximum and minimum values in the range of cells that the conditional formatting rule applies to. For example, if the min and max values in the range are 1 and 10 respectively, and X is 10, then the CFVO value is 1.9.
0x05	The minimum value of the cell that is in X percentile of the range of cells that the conditional formatting rule applies to.
0x07	The result of evaluating fmla .

fmla (variable): A [CFVOParsedFormula](#) that specifies the formula used to calculate the CFVO value. If **cfvoType** is 0x07, then **fmla.cce** MUST be greater than zero.

numValue (8 bytes): An Xnum (section [2.5.342](#)) that specifies a static value used to calculate the CFVO value. MUST be omitted if **fmla.cce** is greater than zero, or if **cfvoType** is equal to 0x02 or 0x03. MUST be greater than 0.0 and less than 100.0 if **cfvoType** is either 0x04 or 0x05

2.5.40 ChartNumNillable

ChartNumNillable is an 8-byte union that specifies a floating-point value, or a non-numeric value defined by the containing record. The type and meaning of the union contents are determined by the most significant 2 bytes, and is defined in the following table:

Value of most significant 2 bytes	Type and meaning of union contents
0xFFFF	A NilChartNum that specifies a non-numeric value, as defined by the containing record.
Any other value.	An Xnum (section 2.5.342) that specifies a floating-point value.

2.5.41 Col

The **Col** structure specifies the zero-based column index of a column in a **sheet**.

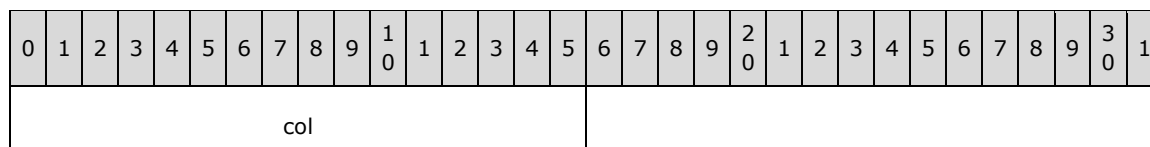

col (2 bytes): An unsigned integer that specifies the zero-based column index of the column in the sheet that contains this structure. MUST be greater than or equal to the **colMic** field of the [Dimensions](#) record of the sheet that contains this structure and MUST be less than the **colMac** field of the Dimensions record of the sheet that contains this structure. MUST be less than or equal to 0x00FF.

2.5.42 Col_NegativeOne

The **Col_NegativeOne** structure specifies the zero-based index of a column in a **sheet**.

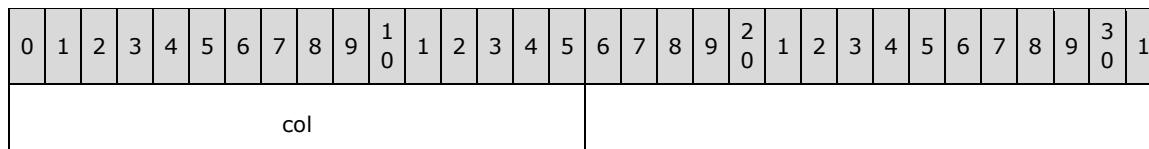

col (2 bytes): A signed integer that specifies the zero-based index of a column in the sheet that contains this structure. The value 0xFFFF specifies a null column index. MUST be greater than or equal to 0xFFFF and less than or equal to 0x00FF.

2.5.43 Col12

The **Col12** structure specifies the zero-based index of a column in a **sheet**.

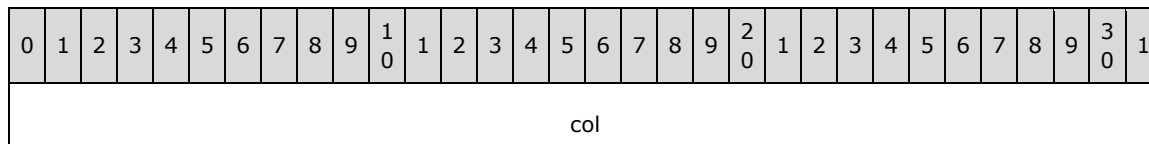

col (4 bytes): A signed integer that specifies a zero-based index of the sheet. MUST be greater than or equal to zero, and MUST be less than or equal to 0x3FFF.

2.5.44 Col256U

The **Col256U** structure specifies the zero-based index of a column in a **sheet**.

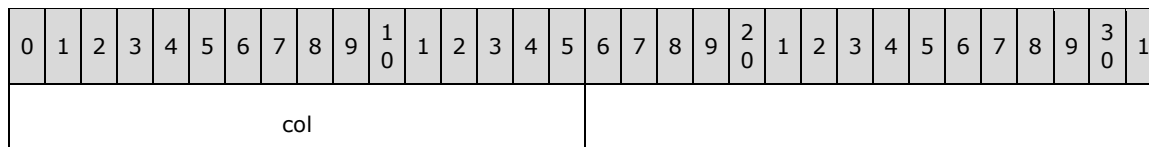

col (2 bytes): An unsigned integer that specifies the zero-based index of a column in the sheet that contains this structure. MUST be less than or equal to 0x0100. The value 0x0100 specifies that the formatting in the containing record also specifies the default column formatting. If additional columns become **visible** at the extreme right of the column **range** because of column deletion, those columns have this default formatting applied.

2.5.45 ColByte

The **ColByte** structure specifies the zero-based index of a column in a **sheet**.

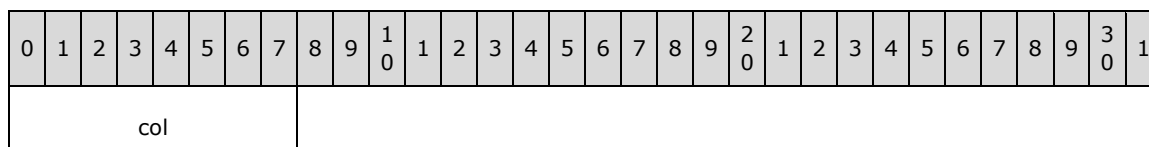

col (1 byte): An unsigned integer that specifies the zero-based index of the column in the sheet that contains this structure. MUST be greater than or equal to the **colMic** field of the [Dimensions](#) record of the sheet that contains this structure and MUST be less than the **colMac** field of the Dimensions record of the sheet that contains this structure.

2.5.46 ColByteU

The **ColByteU** structure specifies the zero-based index of a column in a **sheet**.

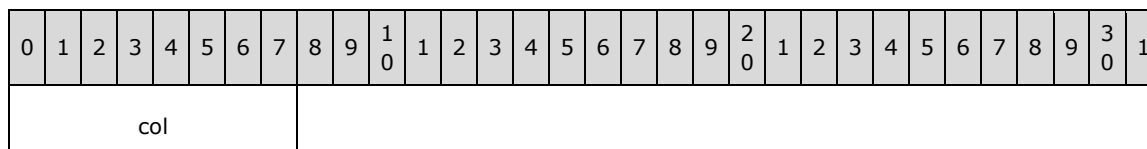

col (1 byte): An unsigned integer that specifies the zero-based index of a column in the sheet that contains this structure.

2.5.47 ColEIfU

The **ColEIfU** structure specifies the zero-based index of a column in a **sheet** and **relative reference** information for this column index and a corresponding row index.

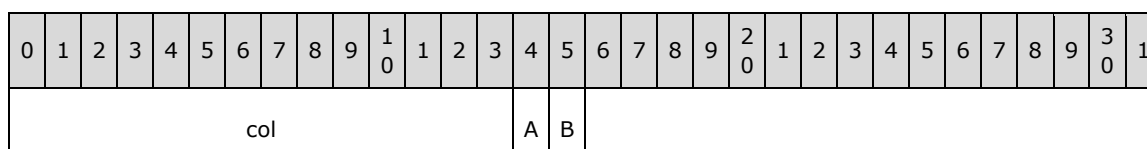

col (14 bits): An unsigned integer that specifies the zero-based index of a column in the sheet that contains this structure. MUST be less than or equal to 0x00FF.

A - fQuoted (1 bit): A bit that specifies if the label occurrences in the **natural language formula** are surrounded by single quote characters.

B - fRelative (1 bit): A bit that specifies whether a corresponding row index from the containing structure and **column** are relative or absolute. MUST be a value from the following table:

Value	Meaning
0x0	A corresponding row index from the containing structure and column are absolute coordinates and are specified by a fixed position in a sheet.
0x1	A corresponding row index from the containing structure and column are relative coordinates and are specified by their position in relation to the current row or current column.

2.5.48 ColorICV

The **ColorICV** structure specifies a color in the color table.

This structure differs from the [IcvXF](#) structure in size (4 bytes versus 7 bits), and the validity of the values 0x40 and 0x41.

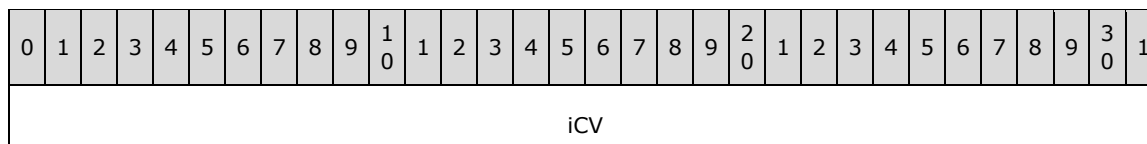

iCV (4 bytes): An unsigned integer that specifies a color in the color table. The value MUST be an IcvXF value. The value MUST NOT be 0x00000040 or 0x00000041.

2.5.49 ColorTheme

The **ColorTheme** structure specifies a color from the document's **theme**.

0	1	2	3	4	5	6	7	8	9	10	11	12	13	14	15	16	17	18	19	20	21	22	23	24	25	26	27	28	29	30	31
iCV																															

iCV (4 bytes): An unsigned integer that specifies one of the colors defined in the **color scheme** of the document's **Theme** record. MUST be one of the following values:

Value	Color from the color scheme
0x00000000	Dark 1
0x00000001	Light 1
0x00000002	Dark 2
0x00000003	Light 2
0x00000004	Accent 1
0x00000005	Accent 2
0x00000006	Accent 3
0x00000007	Accent 4
0x00000008	Accent 5
0x00000009	Accent 6
0x0000000A	Hyperlink
0x0000000B	Followed hyperlink

If this structure is contained in a **CF12** record, the value MUST be different from 0x0000000B.

2.5.50 ColRelNegU

The **ColRelNegU** structure specifies the zero-based column index of a column in a **sheet** offset information for this column index and a corresponding row index.

0	1	2	3	4	5	6	7	8	9	1	0	1	2	3	4	5	6	7	8	9	2	0	1	2	3	4	5	6	7	8	9	3	0	1
col														A	B																			

col (14 bits): A signed integer that specifies the zero-based column index or offset of a column in the sheet that contains this structure. MUST be greater than or equal to -255 be less than or equal to 255.

A - colRelative (1 bit): A bit that specifies whether **col** is an offset.

B - rowRelative (1 bit): bit that specifies whether a row index corresponding to **col** in the structure containing this structure is an offset.

2.5.51 ColRelU

The **ColRelU** structure specifies the zero-based index of a column in a **sheet** and **relative reference** information for this column index and a corresponding row index.

0	1	2	3	4	5	6	7	8	9	1	0	1	2	3	4	5	6	7	8	9	2	0	1	2	3	4	5	6	7	8	9	3	0	1
col														A	B																			

col (14 bits): An unsigned integer that specifies the zero-based index of a column in the sheet that contains this structure. MUST be less than or equal to 0x00FF.

A - colRelative (1 bit): A bit that specifies whether **col** is a relative reference.

B - rowRelative (1 bit): A bit that specifies whether a row index corresponding to **col** in the structure containing this structure is a relative reference.

2.5.52 ColSlco8U

The **ColSlco8U** structure specifies the zero-based index of a column in a **sheet** and information about whether a **cell** has been deleted.

0	1	2	3	4	5	6	7	8	9	1	0	1	2	3	4	5	6	7	8	9	2	0	1	2	3	4	5	6	7	8	9	3	0	1
col														A	B																			

col (14 bits): An unsigned integer that specifies the zero-based index of a column in the sheet that contains this structure. MUST be less than or equal to 0x00FF.

A - fDeleted (1 bit): A bit that specifies whether the cell that is referenced by the containing structure, has been deleted. When set to 1, the **cell reference** of the containing structure MUST be ignored.

B - unused (1 bit): Undefined and MUST be ignored.

2.5.53 ColU

The **ColU** structure specifies the zero-based index of a column in a **sheet**.

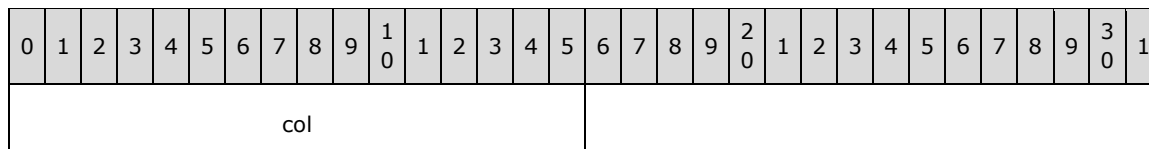

col (2 bytes): An unsigned integer that specifies the zero-based index of a column in the sheet that contains this structure. MUST be less than or equal to 0x00FF.

2.5.54 Colx

The **Colx** structure specifies the zero-based column index of a column in a **sheet**.

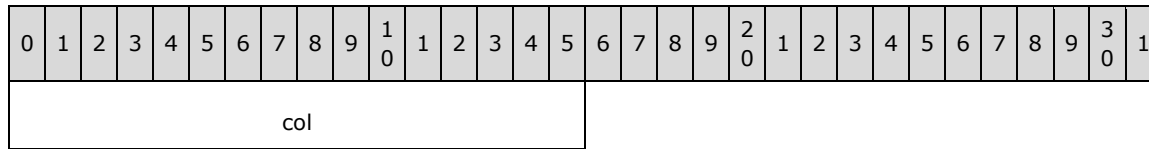

col (2 bytes): An unsigned integer that specifies the zero-based column index of a column in the sheet. The value MUST be 0, 0xFF or be greater than or equal to the **colMic** field of the [Dimensions](#) record of the sheet that contains this structure and less than the **colMac** field of the Dimensions record of the sheet that contains this structure.

2.5.55 CondDataValue

The **CondDataValue** structure specifies the conditional data information.

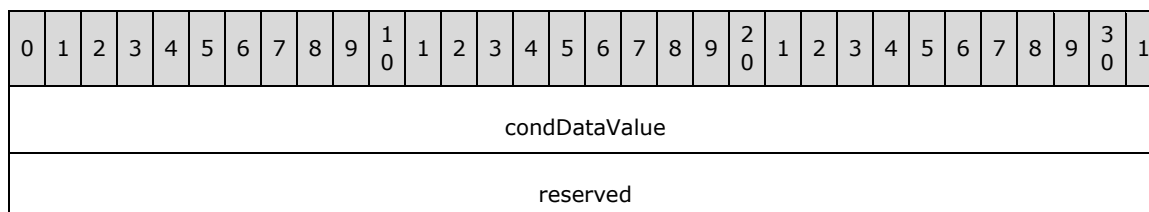

condDataValue (4 bytes): An unsigned integer that specifies a conditional data value. If [SortCond12.sortOn](#) is 0x1 or 0x2, it specifies the zero-based index of a [DXF](#) record in the collection of DXF records in the [Globals Substream](#). The referenced DXF specifies the formatting. If [SortCond12.sortOn](#) is 0x0, this MUST be zero, and MUST be ignored.

reserved (4 bytes): MUST be zero, and MUST be ignored.

2.5.56 CondFmtStructure

The **CondFmtStructure** structure specifies **conditional formatting** rules that are associated with a set of cells in a containing [CondFmt12](#) record.

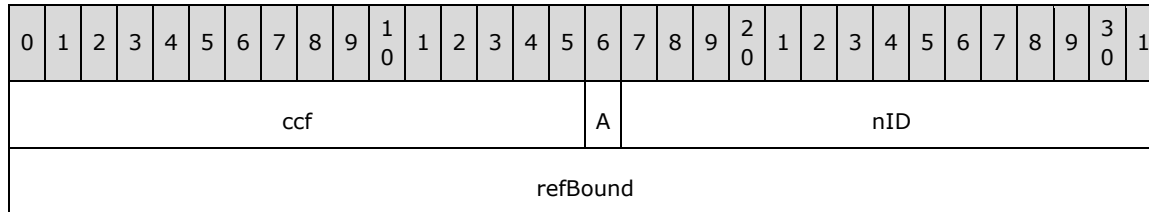

...
sqref (variable)
...

ccf (2 bytes): An unsigned integer that specifies the count of [CF12](#) records that follow the containing record. MUST be greater than or equal to 0x0001.

A - fToughRecalc (1 bit): A bit that specifies that the appearance of the **cell** requires significant processing. This information can be used to optimize the redraw of conditional formatting when data values change.

For example, an application could determine that a conditional formatting rule that contains certain functions or a conditional formatting rule that takes more than a predetermined amount of time to calculate designates that the conditional formatting requires significant processing, and could set this bit to 1.

nID (15 bits): An unsigned integer that identifies this record.

refBound (8 bytes): A [Ref8U](#) structure that specifies bounds of the set of cells to which the rules are applied. The set of cells that it represents MUST include all of the cells represented by field **sqref**.

sqref (variable): A [SqRefU](#) structure that specifies the cells to which the conditional formatting rules apply. **sqref.cref** MUST be greater than zero and less than or equal to 1026.

2.5.57 ConnGrbitDbt

The **ConnGrbitDbt** structure is a 2 byte variable-type structure that specifies [external connection](#) properties for the containing record. Its meaning depends on the value of the **dbt** field of the containing record.

Value	Meaning
4	A ConnGrbitDbtWeb that specifies the query flags for a Web data connection.
5	A ConnGrbitDbtOledb that specifies the query flags for an OLE DB data connection.
7	A ConnGrbitDbtAdo that specifies the query flags for an ADO data connection.
Any other value	A 2 byte unsigned integer. Unused and MUST be 0.

2.5.58 ConnGrbitDbtAdo

The **ConnGrbitDbtAdo** structure specifies the **query** flags for an **ADO** data connection.

0	1	2	3	4	5	6	7	8	9	10	11	12	13	14	15	16	17	18	19	20	21	22	23	24	25	26	27	28	29	30	31
reserved1								A	reserved2																						

reserved1 (8 bits): MUST be zero and MUST be ignored.

A - fAdoRefreshable (1 bit): A bit that specifies if the ADO query can be refreshed.

reserved2 (7 bits): MUST be zero and MUST be ignored.

2.5.59 ConnGrbitDbtOledb

The **ConnGrbitDbtOledb** structure specifies the [external connection](#) properties for an **OLE DB** data connection.

0	1	2	3	4	5	6	7	8	9	10	11	12	13	14	15	16	17	18	19	20	21	22	23	24	25	26	27	28	29	30	31				
dbost										A	B	C	D	E	F	G	H	I	J																

dbost (3 bits): An unsigned integer that specifies the OLE DB command type. This field applies to the database command strings that are saved with the parent records. MUST be a value from the following table:

Name	Value	Meaning
CMDNULL	0x0	The string is not specified.
CMDCUBE	0x1	The string specifies the name of a cube within an OLAP database, see also OLAP Connections .
CMDSQL	0x2	The string specifies an SQL statement.
CMDTABLE	0x3	The string specifies a database table name.
CMDDEFAULT	0x4	The string specifies a statement in the default language of the database.
CMDSPLIST	0x5	The string specifies a list from a Web-based data provider.

A - fLocalConn (1 bit): A bit that specifies which connection string to use for this external connection. MUST be a value from the following table:

Value	Meaning
0x0	Uses the main connection string, as specified by a value of 0 in the fLocal field in OleDbConn , or by a value of 0 or 1 in the rgIOleDbValid of a DConnConnectionOleDb .
0x1	Uses the alternate connection string, as specified by a value of 1 in the fLocal field in OleDbConn , or by a value of 2 or 3 in the rgIOleDbValid of a DConnConnectionOleDb .

B - fNoRefreshCube (1 bit): A bit that specifies whether any local cache of data from the OLAP **data source** is to be flushed when the a refresh is done. The value zero specifies any local cache of data from the OLAP data source is to be flushed when the a refresh is done. MUST be zero and MUST be ignored if the **dbost** field does not equal 0x1.

C - fUseOfficeLcid (1 bit): A bit that specifies whether the user's **locale** information is provided to the OLAP data source for retrieval of translated data and errors. MUST be zero and MUST be ignored if the **dbost** field does not equal 0x1.

D - fSrvFmtNum (1 bit): A bit that specifies whether to apply OLAP data source number formatting to the [PivotTable](#). MUST be zero and MUST be ignored if the **dbost** field does not equal 0x1.

E - fSrvFmtBack (1 bit): A bit that specifies whether to apply OLAP data source **fill** colors to the [PivotTable](#). MUST be zero and MUST be ignored if the **dbost** field does not equal 0x1.

F - fSrvFmtFore (1 bit): A bit that specifies whether to apply OLAP data source **font** colors to the [PivotTable](#). MUST be zero and MUST be ignored if the **dbost** field does not equal 0x1.

G - fSrvFmtFlags (1 bit): A bit that specifies whether to apply OLAP data source font formatting to the [PivotTable](#). MUST be zero and MUST be ignored if the **dbost** field does not equal 0x1.

H - fSupportsLangCellProp (1 bit): A bit that specifies whether the user's locale information is provided to the OLAP data source to support **member (2) localization**. MUST be zero and MUST be ignored if the **dbost** field does not equal 0x1.

I - fSrvSupportsClientCube (1 bit): A bit that specifies that the server supports local embedded data storage.

J - reserved (4 bits): MUST be zero and MUST be ignored.

2.5.60 ConnGrbitDbtWeb

The **ConnGrbitDbtWeb** structure specifies the **query** flags for a Web data connection.

0	1	2	3	4	5	6	7	8	9	10	11	12	13	14	15	16	17	18	19	20	21	22	23	24	25	26	27	28	29	30	31
A	B	C	D	E	F	reserved																									

A - fParsePreFormatted (1 bit): A bit that specifies how text enclosed in <PRE> tags is handled.

Value	Meaning
0x0	Each row of text enclosed in <PRE> tags will be imported as a single cell .
0x1	The text is parsed as tables.

B - fConsecDelim (1 bit): A bit that specifies how consecutive delimiters are treated.

Value	Meaning
0x0	Each consecutive delimiter is treated as a separate delimiter.
0x1	Consecutive delimiters is treated as a single delimiter.

C - fSameSettings (1 bit): A bit that specifies how tables inside <PRE> blocks are parsed.

Value	Meaning
0x0	Each table is parsed separately.
0x1	All tables are parsed with the same width settings as the first row of the first table.

D - fXL97Format (1 bit): A bit that specifies whether the query was created by a specific version of the application [<156>](#).

Value	Meaning
0x0	The query was created by specific versions of the application <157> .
0x1	The query was created by a specific version of the application <158> .

E - fNoDateRecog (1 bit): A bit that specifies how dates are imported.

Value	Meaning
0x0	Dates are imported as values of type date.
0x1	Dates are imported as text.

F - fRefreshedInXI9 (1 bit): A bit that specifies whether the query was refreshed in a specific version of the application <159>.

reserved (10 bits): MUST be zero and MUST be ignored.

2.5.61 ControlInfo

The **ControlInfo** structure specifies the properties of some **form** control in a [Dialog Sheet](#). The control MUST be a group, radio button, label, button or checkbox.

0	1	2	3	4	5	6	7	8	9	10	11	12	13	14	15	16	17	18	19	20	1	2	3	4	5	6	7	8	9	30	1
A	B	C	D	reserved1												accel1															
reserved2																															

A - fDefault (1 bit): A bit that specifies whether this control dismisses the Dialog Sheet and performs the default behavior. If the control is not a button, the value MUST be 0.

B - fHelp (1 bit): A bit that specifies whether this control is intended to load context-sensitive help for the Dialog Sheet. If the control is not a button, the value MUST be 0.

C - fCancel (1 bit): A bit that specifies whether this control dismisses the Dialog Sheet and take no action. If the control is not a button, the value MUST be 0.

D - fDismiss (1 bit): A bit that specifies whether this control dismisses the Dialog Sheet. If the control is not a button, the value MUST be 0.

reserved1 (12 bits): MUST be zero and MUST be ignored.

accel1 (2 bytes): A signed integer that specifies the **Unicode** character of the control's **accelerator key**. The value MUST be greater than or equal to 0x0000. A value of 0x0000 specifies there is no accelerator associated with this control.

reserved2 (2 bytes): Reserved. MUST be 0x0000.

2.5.62 CrtLayout12Mode

The **CrtLayout12Mode** record specifies a layout mode. Each layout mode specifies a different meaning of the **x**, **y**, **dx**, and **dy** fields of [CrtLayout12](#) and [CrtLayout12A](#).

Name	Value	Meaning
L12MAUTO	0x0000	Position and dimension (2) are determined by the application. x , y , dx and dy MUST be ignored.
L12MFACTOR	0x0001	x and y specify the offset of the top left corner, relative to its default position, as a fraction of the chart area (section 2.2.3.17). MUST be greater than or equal to -1.0 and MUST be less than or equal to 1.0. dx and dy specify the width and height, as a fraction of the chart area, MUST be greater than or equal to 0.0, and MUST be less than or equal to 1.0.
L12MEDGE	0x0002	x and y specify the offset of the upper-left corner; dx and dy specify the offset of the bottom-right corner. x , y , dx and dy are specified relative to the upper-left corner of the chart area (section 2.2.3.17) as a fraction of the chart area. x , y , dx and dy MUST be greater than or equal to 0.0, and MUST be less than or equal to 1.0.

2.5.63 DataFunctionalityLevel

The **DataFunctionalityLevel** is a 1 byte unsigned integer that specifies a [data functionality level<160>](#). SHOULD [<161>](#) be 0, 1, or 3. MUST be greater than or equal to 0 and less than or equal to 254.

2.5.64 DataSourceType

The **DataSourceType** enumeration specifies the **data source** types.

Name	Value	Meaning
DBT_ODBC	0x0001	ODBC -based source
DBT_DAO	0x0002	DAO -based source
DBT_WEB	0x0004	Web query
DBT_OLEDB	0x0005	OLE DB -based source
DBT_TXT	0x0006	Text-based source created via text query
DBT_ADO	0x0007	ADO record set

2.5.65 DateAsNum

The **DateAsNum** structure specifies a date and time value stored as an Xnum (section [2.5.342](#)).

0	1	2	3	4	5	6	7	8	9	10	11	12	13	14	15	16	17	18	19	20	21	22	23	24	25	26	27	28	29	30	31
dateNum																															
...																															

dateNum (8 bytes): An Xnum that specifies a date and time value. The value uses the double-precision floating point number in the Xnum structure as follows: The integer part of the number specifies the date as a number of days from a base date [<162>](#), and the fractional part specifies the time of day as a fraction of a 24-hour day. The base date for the number of days is determined by the **date system** used in the **workbook**, as specified by the [Date1904](#) record in the [Globals Substream](#), according to the following table:

Date system	Meaning
1900	A value of 1 to dateNum specifies 00:00:00 on January 1, 1900.
1904	A value of 0 to dateNum specifies 00:00:00 on January 1, 1904.

2.5.66 DateUnit

The **DateUnit** enumeration specifies the unit of measurement of a date value.

Name	Value	Meaning
DUDAYS	0x0000	Time value is measured in days.
DUMONTHS	0x0001	Time value is measured in months.
DUYEARS	0x0002	Time value is measured in years.

2.5.67 DCol

The **DCol** structure specifies a count of column indexes in a **sheet**.

0	1	2	3	4	5	6	7	8	9	10	11	12	13	14	15	16	17	18	19	20	1	2	3	4	5	6	7	8	9	30	1
dcol																															

dcol (2 bytes): An unsigned integer that specifies the count of column indexes in a sheet.

2.5.68 DColByteU

The **DColByteU** structure specifies a count or difference of column indexes in a **sheet**.

0	1	2	3	4	5	6	7	8	9	10	11	12	13	14	15	16	17	18	19	20	1	2	3	4	5	6	7	8	9	30	1
dcol																															

dcol (1 byte): An unsigned integer that specifies the count of column indexes in a sheet.

2.5.69 DConFile

The **DConFile** structure specifies the **workbook** file or workbook file and **sheet** that contain a **data source range**. This structure is used by the [DConBin](#), [DConRef](#) and [DConName](#) records.

0	1	2	3	4	5	6	7	8	9	10	11	12	13	14	15	16	17	18	19	20	1	2	3	4	5	6	7	8	9	30	1
stFile (variable)																															
...																															

stFile (variable): An [XLUnicodeStringNoCch](#) that specifies the workbook file or workbook file and sheet that contain the range specified in the DConBin, DConRef or DConName record.

MUST be a string that conforms to the following ABNF grammar:

```
dcon-file = external-virt-path / self-reference
```

```
external-virt-path = volume / unc-volume / rel-volume / transfer-protocol / startup / alt-  
startup / library / simple-file-path-dcon
```

```
simple-file-path-dcon = %x0001 file-path
```

self-reference = %x0002 sheet-name

See [VirtualPath](#) for the definition of the volume, unc-volume, rel-volume, transfer-protocol, startup, alt-startup, library, file-path and sheet-name rules used in the **ABNF** grammar. Note that the volume, unc-volume, rel-volume, transfer-protocol, startup, alt-startup, library, and file-path rules specify that an optional sheet name can be included.

If this structure is contained in a DConName or DConBin record and the **defined name** has a workbook scope, then this string MUST satisfy the external-virt-path rule and MUST NOT specify a sheet name. Otherwise a sheet name MUST be specified.

2.5.70 DConnConnectionOleDb

The **DConnConnectionOleDb** structure specifies data connection properties of an **OLE DB** data connection.

0	1	2	3	4	5	6	7	8	9	10	11	12	13	14	15	16	17	18	19	20	21	22	23	24	25	26	27	28	29	30	31
nDrillthroughRows																															
cOleDb																rgIOleDbValid (variable)															
...																															
rgIOleDbInvalid (variable)																															
...																															
unused																rgConn (variable)															
...																															

nDrillthroughRows (4 bytes): An unsigned integer that specifies the maximum number of rows that the application will retrieve during a **drillthrough** operation on a [PivotTable](#) based on this data connection.

cOleDb (2 bytes): An unsigned integer that specifies the number of **connection strings** associated with the OLE DB connection specified in **rgConn**. MUST be less than or equal to 4. MUST be equal to 0 if the **fStandAlone** field of the associated [DConn](#) of structure is 0.

rgIOleDbValid (variable): An array of 2-byte unsigned integers that specify the type of connection strings in **rgConn**. The size of the array MUST be equal to **cOleDb**. Each element of the array MUST be unique within **rgIOleDbValid**. Each element of the array MUST be from the following table:

Value	Meaning of string in rgConn
0	The main connection string of the connection. This element MUST exist.
1	The variant of the main connection string that has the password removed.
2	The connection string to the local cube file.
3	The variant of the connection string to the local cube file that has the password removed.

rgIOleDbInvalid (variable): Undefined and MUST be ignored. The size of the field, in bytes, MUST equal the value specified by the following formula:

$$2 * (4 - cOleDb)$$

unused (2 bytes): Undefined and MUST be ignored.

rgConn (variable): An array of [DConnUnicodeStringSegmented](#). The array specifies the connection strings associated with the OLE DB connection that correspond to the elements in **rgIOleDbValid**. The number of elements in the array MUST be equal to **cOleDb**. This field MUST NOT exist if **cOleDb** equals 0. The meaning of each item in **rgConn** is defined by the item with a matching index in **rgIOleDbValid** as defined in the table under **rgIOleDbValid**.

2.5.71 DConnConnectionWeb

The **DConnConnectionWeb** structure specifies data connection properties of **Web query** data connections.

0	1	2	3	4	5	6	7	8	9	10	11	12	13	14	15	16	17	18	19	20	21	22	23	24	25	26	27	28	29	30	31
rgbURL (variable)																															
...																															
rgbWebPost (variable)																															
...																															

rgbURL (variable): A [DConnStringSequence](#) that specifies the URL for a Web query.

rgbWebPost (variable): A [DConnStringSequence](#) that specifies the **post method** for a Web query.

2.5.72 DConnId

The **DConnId** structure specifies the identifier of the object that a connection is associated with.

0	1	2	3	4	5	6	7	8	9	10	11	12	13	14	15	16	17	18	19	20	21	22	23	24	25	26	27	28	29	30	31					
bType										data (variable)																										
...																																				

bType (1 byte): An unsigned integer that specifies the identifier type. MUST be a value as specified in the table listed under field **data**.

data (variable): A variable field that specifies the identifier of the object whose type and meaning are dictated by the value of field **bType**, as specified in the following table:

bType Value	Meaning
0	This field does not exist. There is no associated object.
1	A DConnUnicodeStringSegmented that specifies the name of a query table .
2	An SXStreamID that specifies the stream in the PivotCache storage .

2.5.73 DConnParamBinding

The **DConnParamBinding** structure that specifies a parameter's binding value based on field **pbt** of structure [DConnParameter](#).

Value	Meaning
0	A DConnUnicodeStringSegmented that specifies the parameter prompt.
1	A DConnParamBindingValType structure that specifies the parameter value as defined in the query .

2.5.74 DConnParamBindingValByte

The **DConnParamBindingValByte** structure specifies the parameter binding.

0	1	2	3	4	5	6	7	8	9	10	11	12	13	14	15	16	17	18	19	20	21	22	23	24	25	26	27	28	29	30	31
fVal										reserved1																					
reserved2																															

fVal (8 bits): An unsigned integer that specifies the binding Boolean value.

reserved1 (24 bits): MUST be zero and MUST be ignored.

reserved2 (4 bytes): MUST be zero and MUST be ignored.

2.5.75 DConnParamBindingValInt

The **DConnParamBindingValInt** structure specifies the parameter binding.

0	1	2	3	4	5	6	7	8	9	10	11	12	13	14	15	16	17	18	19	20	21	22	23	24	25	26	27	28	29	30	31
val																															
reserved																															

val (4 bytes): An unsigned integer that specifies the binding value.

reserved (4 bytes): MUST be zero and MUST be ignored.

2.5.76 DConnParamBindingValString

The **DConnParamBindingValString** structure specifies properties for a data connection parameter that has a string data type.

0	1	2	3	4	5	6	7	8	9	10	11	12	13	14	15	16	17	18	19	20	21	22	23	24	25	26	27	28	29	30	31
reserved																															

...
rgchBindingValueStr (variable)
...

reserved (8 bytes): MUST be zero and MUST be ignored.

rgchBindingValueStr (variable): A [DConnUnicodeStringSegmented](#) that specifies the value for a data connection parameter.

2.5.77 DConnParamBindingValType

The **DConnParamBindingValType** structure specifies properties for a data connection parameter.

0	1	2	3	4	5	6	7	8	9	10	11	12	13	14	15	16	17	18	19	20	21	22	23	24	25	26	27	28	29	30	31
wBindingValueGrbt																rgbBindingValue (variable)															
...																															

wBindingValueGrbt (2 bytes): An unsigned integer that specifies the data type of the parameter. MUST be a value from the table as specified in the **rgbBindingValue** field.

rgbBindingValue (variable): A variable type field whose type and meaning are specified by the value of **wBindingValueGrbt** as specified in the following table:

wBindingValueGrbt Value	Meaning
0x0001	An Xnum (section 2.5.342) that specifies the value for a parameter that has a numeric data type.
0x0002	A DConnParamBindingValString that specifies the value for a parameter that has a string data type.
0x0004	A DConnParamBindingValByte that specifies the value for a parameter that has a Boolean data type.
0x0800	A DConnParamBindingValInt that specifies the value for a parameter that has an integer data type.

2.5.78 DConnParameter

The **DConnParameter** structure specifies a parameter of a **parameterized query**.

0	1	2	3	4	5	6	7	8	9	10	11	12	13	14	15	16	17	18	19	20	21	22	23	24	25	26	27	28	29	30	31
rgchName (variable)																															
...																															
pbt				reserved																wTypeSql											

A	unused	paramBinding (variable)
...		

rgchName (variable): A [DConnUnicodeStringSegmented](#) that specifies the name of the parameter.

pbt (3 bits): An unsigned integer that specifies the parameter type. MUST be a value from the following table:

Value	Meaning
0x0	Prompt. User is prompted for the value of the parameter.
0x1	Value. The parameter value is specified in the query .

reserved (13 bits): MUST be zero and MUST be ignored.

wTypeSql (2 bytes): An [ODBCType](#) structure that specifies the **ODBC** data type as returned by the ODBC provider of the data. This signed integer specifies the **SQL** data type.

A - fDefaultName (1 bit): A bit that specifies whether a default name has been assigned by the application to the parameter. MUST be a value from the following table:

Value	Meaning
0x0	The user specified a name for the parameter.
0x1	The application specified a name for the parameter.

unused (15 bits): Undefined and MUST be ignored.

paramBinding (variable): A [DConnParamBinding](#) structure that specifies the parameter's bindings.

2.5.79 DConnStringSequence

The **DConnStringSequence** structure specifies a sequence of strings.

0	1	2	3	4	5	6	7	8	9	10	11	12	13	14	15	16	17	18	19	20	21	22	23	24	25	26	27	28	29	30	31
cst																rgString (variable)															
...																															

cst (2 bytes): An unsigned integer that specifies the number of strings in the **rgString** array.

rgString (variable): An array of [DConnUnicodeStringSegmented](#) that specifies a segmented **Unicode** string.

2.5.80 DConnUnicodeStringSegmented

The **DConnUnicodeStringSegmented** structure specifies a segmented Unicode string.

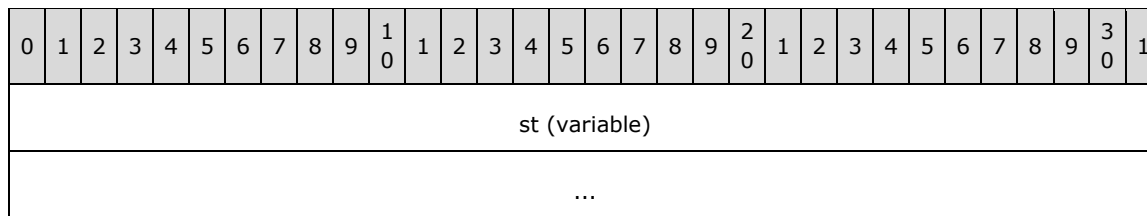

st (variable): An [XLUnicodeStringSegmented](#) that specifies a segmented Unicode string.

2.5.81 DJoin

The **DJoin** enumeration specifies the join type for two data operations.

Name	Value	Meaning
DJOINNULL	0x00000000	None
DJOINAND	0x00000001	And
DJOINOR	0x00000002	Or

2.5.82 DRw

The **DRw** structure specifies a count of row indexes in a **sheet**.

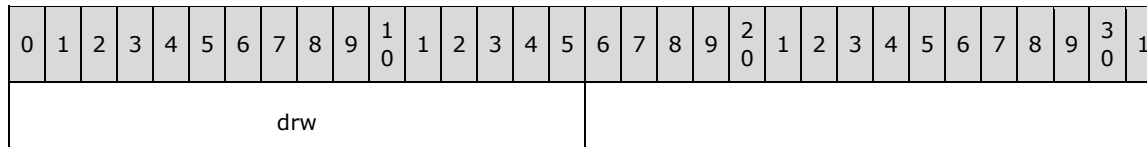

drw (2 bytes): An unsigned integer that specifies the count or difference of row indexes in a sheet.

2.5.83 DRwByteU

The **DRwByteU** structure specifies a count of row indexes in a **sheet**.

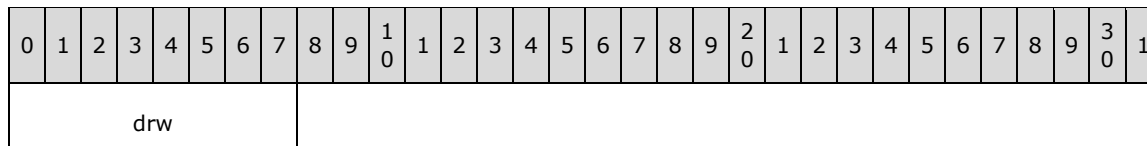

drw (1 byte): An unsigned integer that specifies the count or difference of row indexes in a sheet.

2.5.84 Duce

The **Duce** structure specifies additional undo data that is applied to an **expression** that uses a **natural language formula** if the **revision** is rejected.

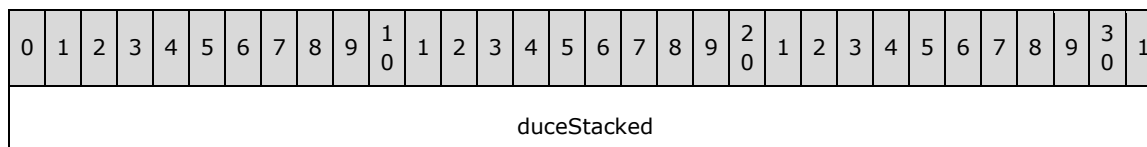

duceRadical		
...		
...	eptg	rgloc (variable)
...		

duceStacked (4 bytes): A [DuceStacked](#) that specifies additional undo data used for the natural language formula.

duceRadical (9 bytes): A [DuceRadical](#) that specifies additional undo data used for the natural language formula. If **eptg** does not specify that this natural language formula is an ElfRadical, then this field is undefined and MUST be ignored.

eptg (1 byte): An unsigned integer that specifies the type of natural language formula. **eptg** MUST equal the second byte of the [Ptg](#) specified by the **ptg** field of the [Ducr](#) that contains this structure. The type of the natural language formula is either ElfStacked or ElfRadical, neither or both.

eptg MUST be a value from the following table.

Value	ElfStacked	ElfRadical
0x02	No	No
0x03	No	No
0x06	No	No
0x07	No	No
0x0A	No	Yes
0x0B	Yes	Yes
0x0D	Yes	No
0x0F	Yes	No

ElfStacked: A natural language formula is considered to be stacked if more than one **cell** is used for the label. ElfRadical: A natural language formula is considered to be radical if the formula (section [2.2.2](#)) refers to more than one cell.

rgloc (variable): An array of [RRLoc](#) structures. The number of elements is specified by the **cLoc** field of **duceStacked**. MUST exist if and only if the type of the natural language formula as specified by **eptg** is ElfStacked. The **fNoDollarOnLabel** field of each RRLoc structure in the array is undefined and MUST be ignored.

2.5.85 DuceRadical

The **DuceRadical** structure specifies additional undo data associated with a **natural language formula**.

0	1	2	3	4	5	6	7	8	9	10	1	2	3	4	5	6	7	8	9	20	1	2	3	4	5	6	7	8	9	30	1	
refRadical (optional)																																
...																																

unused (optional)	
...	
ptgRadical	

refRadical (8 bytes): A [Ref8U](#) that specifies the **cells** referenced by the natural language formula. MUST exist if and only if **ptgRadical** is a [PtgArea](#).

unused (8 bytes): An array of 1-byte signed integers. Undefined and MUST be ignored. MUST exist if and only if **ptgRadical** is equal to [PtgAreaErr](#).

ptgRadical (1 byte): An unsigned integer that specifies the next [Ptg](#) in the formula (section [2.2.2](#)) associated with this natural language formula. MUST either be a [PtgArea](#) or a [PtgAreaErr](#).

2.5.86 DuceStacked

The type and meaning of the **DuceStacked** structure are specified by the type of the **eptg** field of the [Duce](#) structure that contains this structure, as specified in the following table:

Value	Meaning
1	This structure specifies an SQElfFlags that specifies additional undo data associated with the natural language formula .
0	This structure specifies an RRLoc that specifies the location affected by the natural language formula.

2.5.87 Ducr

The **Ducr** structure specifies undo data that is applied to an **expression** that was affected by an [insertion / deletion of rows / columns revision](#) or a [move cells revision](#) if the **revision** is rejected.

0	1	2	3	4	5	6	7	8	9	1	0	1	2	3	4	5	6	7	8	9	2	0	1	2	3	4	5	6	7	8	9	3	0	1
reserved1																																		
iptg											ptg											A	B	reserved2										
duce (variable)																																		
...																																		
duceRadical (optional)																																		
...																																		
ducr_cond_1 (variable)																																		
...																																		
ducr_cond_2 (optional)																																		

...

reserved1 (4 bytes): MUST be zero, and MUST be ignored.

iptg (2 bytes): An unsigned integer that specifies a zero-based index of a [Ptg](#) structure in the array specified by the [Rgce](#) structure associated with the affected expression. The referenced Ptg specifies which Ptg is affected by the revision.

ptg (1 byte): The Ptg before the revision action occurred.

A - fLbl (1 bit): A bit that specifies whether the affected expression is contained in a **defined name**.

B - fUseSh2 (1 bit): A bit that specifies whether the affected expression is on a different **sheet**. MUST be zero for [RRDInsDel](#).

reserved2 (6 bits): MUST be zero, and MUST be ignored.

duce (variable): A [Duce](#) that specifies additional undo data that is used for a **natural language formula**. MUST exist if and only if **ptg** is equal to 0x18.

duceRadical (8 bytes): A variable type field with the type and meaning determined by the value of **ptg**, as specified in the following table. MUST exist if and only if **ptg** is not equal to 0x18.

ptg Value	Type
PtgRef	A RgceLoc8 that specifies the cell reference originally contained by the expression.
PtgRef3d	A RgceLoc8 that specifies the cell reference originally contained by the expression.
PtgArea	A RgceArea that specifies a reference to a rectangular range of cells originally contained by the expression.
PtgArea3d	A RgceArea that specifies a reference to a rectangular range of cells originally contained by the expression.
All other values	MUST be zero, and MUST be ignored.

ducr_cond_1 (variable): A [DucrConditionalLbl](#) that specifies defined name information associated with the affected expression. MUST exist if and only if **fLbl** equals 1.

ducr_cond_2 (6 bytes): A [DucrConditionalNoLbl](#) that specifies location information associated with the affected expression. MUST exist if and only if **fLbl** equals 0.

2.5.88 DucrConditionalLbl

The **DucrConditionalLbl** structure specifies information associated with the **defined name** in the [Ducr](#) structure.

0	1	2	3	4	5	6	7	8	9	10	11	12	13	14	15	16	17	18	19	20	21	22	23	24	25	26	27	28	29	30	31
tabid															builtinIndex						unused (optional)										
...															stDefName (variable)																
...																															

tabid (2 bytes): A [TabId](#) that specifies the **sheet** containing the defined name. A value of 0xFFFF specifies that the defined name is not associated with the sheet.

builtinIndex (1 byte): An unsigned integer that specifies the identifier of a **built-in name**. MUST be a value from the following table:

Value	Meaning
0x00	Not a built-in name
0x01	The built-in name is "Consolidate_Area"
0x02	The built-in name is "Auto_Open"
0x03	The built-in name is "Auto_Close"
0x04	The built-in name is "Extract"
0x05	The built-in name is "Database"
0x06	The built-in name is "Criteria"
0x07	The built-in name is "Print_Area"
0x08	The built-in name is "Print_Titles"
0x09	The built-in name is "Recorder"
0x0A	The built-in name is "Data_Form"
0x0B	The built-in name is "Auto_Activate"
0x0C	The built-in name is "Auto_Deactivate"
0x0D	The built-in name is "Sheet_Title"
0x0E	The built-in name is "_FilterDatabase"

unused (3 bytes): Undefined and MUST be ignored. MUST exist if and only if **builtinIndex** is not equal to zero.

stDefName (variable): An [XLUnicodeString](#) that specifies the defined name. MUST exist if and only if **builtinIndex** is equal to zero.

2.5.89 DucrConditionalNoLbl

The **DucrConditionalNoLbl** structure specifies location information associated with the [Ducr](#) structure.

0	1	2	3	4	5	6	7	8	9	10	11	12	13	14	15	16	17	18	19	20	21	22	23	24	25	26	27	28	29	30	31
tabid																loc															
...																															

tabid (2 bytes): A [TabId](#) that specifies the **sheet** containing the affected **expression**.

loc (4 bytes): An [RRLoc](#) that specifies the location of the **cell** containing the affected expression. The **fQuotesOnLabel** and **fNoDollarOnLabel** fields in the RRLoc structure are undefined and MUST be ignored.

2.5.90 DwQsiFuture

The **DwQsiFuture** structure specifies option flags for a **query table**.

0	1	2	3	4	5	6	7	8	9	10	11	12	13	14	15	16	17	18	19	20	21	22	23	24	25	26	27	28	29	30	31
A	B	C	D	E	F	G	H	I	reserved5							reserved6															

A - fPreserveFmt (1 bit): A bit that specifies whether the user applied formatting is preserved.

B - fAutoFit (1 bit): A bit that specifies whether columns be auto fit after a data **refresh**.

C - reserved1 (1 bit): MUST be zero, and MUST be ignored.

D - reserved2 (1 bit): MUST be zero, and MUST be ignored.

E - fExtDataList (1 bit): A bit that specifies whether an **external data** list is the **data source** for the query table.

F - reserved3 (1 bit): MUST be zero, and MUST be ignored.

G - fCreateQTLList (1 bit): A bit that specifies whether a query table list is to be created.

H - fDummyList (1 bit): A bit that specifies whether a dummy query table list is created.

I - reserved4 (1 bit): MUST be zero, and MUST be ignored.

reserved5 (7 bits): MUST be zero, and MUST be ignored.

reserved6 (16 bits): MUST be zero, and MUST be ignored.

2.5.91 DXFALC

The **DXFALC** structure specifies the text alignment properties within a containing [DXFN](#) structure.

0	1	2	3	4	5	6	7	8	9	10	11	12	13	14	15	16	17	18	19	20	21	22	23	24	25	26	27	28	29	30	31
alc			A	alcv			B	trot							cIndent				C	D	E	unused									
iIndent																															

alc (3 bits): A [HorizAlign](#) that specifies the **horizontal alignment** of the text.

A - fWrap (1 bit): A bit that specifies the text display when the text is wider than the **cell**.

Value	Meaning
0	The text is truncated.
1	The text is wrapped into more than one line.

alcv (3 bits): A [VertAlign](#) that specifies the **vertical alignment** of the text.

B - fJustLast (1 bit): A bit that specifies whether cell text is **justify distributed**. If **fJustLast** is 1 the text is justify distributed and **alc** MUST be 0x7.

trot (8 bits): An [XFPropTextRotation](#) that specifies the text rotation.

cIndent (4 bits): An unsigned integer that specifies the absolute level of indentation. The absolute level of indentation will replace any previous indentation. MUST be ignored when **iIndent** is not 255. MUST be less than or equal to 15.

C - fShrinkToFit (1 bit): A bit that specifies whether the character sizes in the text MUST be reduced so that the text fits in the cell.

D - fMergeCell (1 bit): A bit that specifies that the cell MUST be merged.

E - iReadingOrder (2 bits): A [ReadingOrder](#) that specifies the **reading order**. If **fZeroInited** in the parent structure is zero, then it is undefined and MUST be ignored.

unused (8 bits): Undefined and MUST be ignored.

iIndent (4 bytes): A signed integer that specifies the relative level of indentation. The relative level of indentation will be added to any previous indentation. The value MUST be greater than or equal to -15 and less than or equal to 255. The value SHOULD [<163>](#) be greater than or equal to -15 and less than or equal to 15, or be equal to 255. The values -250 through 250 specify a relative indentation level, and the value 255 specifies the absence of a relative indentation level.

2.5.92 DXFBdr

The **DXFBdr** structure specifies the **style** of **cell** borders in a containing [DXFN](#) structure.

0	1	2	3	4	5	6	7	8	9	10	11	12	13	14	15	16	17	18	19	20	21	22	23	24	25	26	27	28	29	30	31
dgLeft				dgRight				dgTop				A				icvLeft				icvRight				B		C					
icvTop							icvBottom							icvDiag							dgDiag		unused								

dgLeft (4 bits): A [BorderStyle](#) that specifies the grid **line style** for the left **border** of the cell.

dgRight (4 bits): A [BorderStyle](#) that specifies the grid line style for the right border of the cell.

dgTop (4 bits): A [BorderStyle](#) that specifies the grid line style for the top border of the cell.

A - dgBottom (4 bits): A [BorderStyle](#) that specifies the grid line style for the bottom border of the cell.

icvLeft (7 bits): An [IcvXF](#) that specifies the color of the left border of the cell or unused. This value is unused and MUST be ignored if **dgLeft** is 0 or if the **gLeftNinch** field in the containing DXFN structure is 1.

icvRight (7 bits): An [IcvXF](#) that specifies the color of the right border of the cell or unused. This value is unused and MUST be ignored if **dgRight** is 0 or if the **gRightNinch** field in the containing DXFN structure is 1.

B - bitDiagDown (1 bit): A bit that specifies if the cell has a downward diagonal drawn.

C - bitDiagUp (1 bit): A bit that specifies if the cell has an upward diagonal drawn.

icvTop (7 bits): An [IcvXF](#) that specifies the color of the top border of the cell or unused. This value is unused and MUST be ignored if **dgTop** is 0 or if the **gTopNinch** field in the containing DXFN structure is 1.

icvBottom (7 bits): An [IcvXF](#) that specifies the color of the bottom border of the cell or unused. This value is unused and MUST be ignored if **dgBottom** is 0 or if the **gBottomNinch** field in the containing DXFN structure is 1.

icvDiag (7 bits): An IcvXF that specifies the color of the diagonals of the cell or unused. This value is unused and MUST be ignored if **dgDiag** is 0 or if the **gIDiagDownNinch** and the **gIDiagUpNinch** fields in the containing DXFN are both 1.

dgDiag (4 bits): A BorderStyle that specifies the grid line style for the diagonals of the cell..

unused (7 bits): Undefined and MUST be ignored.

2.5.93 DXFFntD

The **DXFFntD** structure specifies a **font** and its format attributes.

0	1	2	3	4	5	6	7	8	9	10	11	12	13	14	15	16	17	18	19	20	21	22	23	24	25	26	27	28	29	30	31					
cchFont										stFontName (variable)																										
...																																				
unused1 (variable)																																				
...																																				
stxp (16 bytes)																																				
...																																				
...																																				
icvFore																																				
reserved																																				
tsNinch																																				
fSssNinch																																				
fUlsNinch																																				
fBlsNinch																																				
unused2																																				
ich																																				
cch																																				
iFnt																																				

cchFont (1 byte): An unsigned integer that specifies the number of characters of the font name string.

stFontName (variable): An [XLUnicodeStringNoCch](#) that specifies the font name. MUST exist if and only if **cchFont** is greater than zero. The number of characters in the string is specified in **cchFont**. If **stFontName.fHighByte** equals 0x0, **cchFont** MUST be less than or equal to 62. If **stFontName.fHighByte** equals 0x1, **cchFont** MUST be less than or equal to 31.

unused1 (variable): Undefined and MUST be ignored. The size of this field is 63 minus the size of the **stFontName** field. If the **stFontName** field doesn't exist, the size of this field is 63.

stxp (16 bytes): A [Stxp](#) that specifies the font attributes.

icvFore (4 bytes): An integer that specifies the color of the font. The value MUST be -1, 32767 or any of the valid values of the [IcvFont](#) structure. A value of -1 specifies that this value is ignored. A value of 32767 specifies that the color of the font is the default foreground text color. Any other value specifies the color of the font as specified in the [IcvFont](#) structure.

reserved (4 bytes): MUST be zero, and MUST be ignored.

tsNinch (4 bytes): A [Ts](#) structure that specifies how the value of **stxp.ts** is to be interpreted. If **tsNinch.ftsItalic** is set to 1 then the value of **stxp.ts.ftsItalic** MUST be ignored. If **tsNinch.ftsStrikeout** is set to 1 then the value of the **stxp.ts.ftsStrikeout** MUST be ignored.

fSssNinch (4 bytes): A Boolean (section [2.5.14](#)) that specifies whether the value of **stxp.sss** MUST be ignored.

fUlsNinch (4 bytes): A Boolean that specifies whether the value of **stxp.uls** MUST be ignored.

fBlisNinch (4 bytes): A Boolean that specifies whether the value of **stxp.blis** MUST be ignored.

unused2 (4 bytes): Undefined and MUST be ignored.

ich (4 bytes): A signed integer that specifies the zero based index of the first character to which this font applies. MUST be greater than or equal to 0xFFFFFFFF. MUST be set to 0xFFFFFFFF when the font is to be updated.

cch (4 bytes): A signed integer that specifies the number of characters to which this font applies. MUST be greater than or equal to **ich** field. MUST be set to 0xFFFFFFFF if the **ich** field is set to 0xFFFFFFFF.

iFnt (2 bytes): An unsigned integer that specifies the font. If the value is 0 then the default font is used. If the value is greater than 0 then the font to be applied is determined by the font name specified in **stFontName**.

2.5.94 DXFId

The **DXFId** structure specifies a [DXF](#) structure.

0	1	2	3	4	5	6	7	8	9	10	11	12	13	14	15	16	17	18	19	20	21	22	23	24	25	26	27	28	29	30	31
index																															

index (4 bytes): An unsigned integer that specifies a zero-based index of a DXF record in the collection of DXF records in the [Globals Substream](#).

2.5.95 DXFN

The **DXFN** structure specifies [differential formatting](#).

0	1	2	3	4	5	6	7	8	9	10	11	12	13	14	15	16	17	18	19	20	1	2	3	4	5	6	7	8	9	30	1	
A	B	C	D	E	F	G	H	I	J	K	L	M	N	O	P	Q	R	S	T	U	V	W				X	Y	Z	a	b	c	d
e	f	g	reserved2												h	dxfnun (variable)																
...																																
dxffntd (variable)																																
...																																
dxfalcn (optional)																																
...																																
dxfbdr (optional)																																
...																																
dxfpnt (optional)																																
dxfpnt (optional)																																

- A - alchNinchn (1 bit):** A bit that specifies whether the value of **dxfalcn.alc** MUST be ignored.
- B - alcvninchn (1 bit):** A bit that specifies whether the value of **dxfalcn.alcv** MUST be ignored.
- C - wrapNinchn (1 bit):** A bit that specifies whether the value of **dxfalcn.fWrap** MUST be ignored.
- D - trotNinchn (1 bit):** A bit that specifies whether the value of **dxfalcn.trot** MUST be ignored.
- E - kintoNinchn (1 bit):** A bit that specifies whether the value of **dxfalcn.fJustLast** MUST be ignored .
- F - cIndentNinchn (1 bit):** A bit that specifies whether the values of **dxfalcn.cIndent** and **dxfalcn.iIndent** MUST be ignored.
- G - fShrinkNinchn (1 bit):** A bit that specifies whether the value of **dxfalcn.fShrinkToFit** MUST be ignored.
- H - fMergeCellNinchn (1 bit):** A bit that specifies whether the value of **dxfalcn.fMergeCell** MUST be ignored.
- I - lockedNinchn (1 bit):** A bit that specifies whether the value of **dxfpnt.fLocked** MUST be ignored.
- J - hiddenNinchn (1 bit):** A bit that specifies whether the value of **dxfpnt.fHidden** MUST be ignored.
- K - glLeftNinchn (1 bit):** A bit that specifies whether the values of **dxfbdr.dgLeft** and **dxfbdr.icvLeft** MUST be ignored .
- L - glRightNinchn (1 bit):** A bit that specifies whether the values of **dxfbdr.dgRight** and **dxfbdr.icvRight** MUST be ignored.

- M - glTopNinch (1 bit):** A bit that specifies whether the values of **dxfbdr.dgTop** and **dxfbdr.icvTop** MUST be ignored.
- N - glBottomNinch (1 bit):** A bit that specifies whether the values of **dxfbdr.dgBottom** and **dxfbdr.icvBottom** MUST be ignored.
- O - glDiagDownNinch (1 bit):** A bit that specifies whether the value of **dxfbdr.bitDiagDown** MUST be ignored. When both **glDiagDownNinch** and **glDiagUpNinch** are set to 1, the values of **dxfbdr.dgDiag** and **dxfbdr.icvDiag** MUST be ignored.
- P - glDiagUpNinch (1 bit):** A bit that specifies whether the value of **dxfbdr.bitDiagUp** MUST be ignored. When both **glDiagDownNinch** and **glDiagUpNinch** are set to 1, the values of **dxfbdr.dgDiag** and **dxfbdr.icvDiag** MUST be ignored.
- Q - flsNinch (1 bit):** A bit that specifies whether the value of **dxfpat.flS** MUST be ignored.
- R - icvFNinch (1 bit):** A bit that specifies whether the value of **dxfpat.icvForeground** MUST be ignored.
- S - icvBNinch (1 bit):** A bit that specifies whether the value of **dxfpat.icvBackground** MUST be ignored.
- T - ifmtNinch (1 bit):** A bit that specifies whether the value of **dxffnum.ifmt** MUST be ignored.
- U - flfntNinch (1 bit):** A bit that specifies whether the value of **dxffntd.ifnt** MUST be ignored.
- V - unused1 (1 bit):** Undefined and MUST be ignored.
- W - reserved1 (3 bits):** MUST be zero and MUST be ignored.
- X - ibitAtrNum (1 bit):** A bit that specifies whether number formatting information is part of this structure.
- Y - ibitAtrFnt (1 bit):** A bit that specifies whether **font** information is part of this structure.
- Z - ibitAtrAlc (1 bit):** A bit that specifies whether alignment information is part of this structure.
- a - ibitAtrBdr (1 bit):** A bit that specifies whether **border formatting** information is part of this structure.
- b - ibitAtrPat (1 bit):** A bit that specifies whether pattern information is part of this structure.
- c - ibitAtrProt (1 bit):** A bit that specifies whether rotation information is part of this structure.
- d - iReadingOrderNinch (1 bit):** A bit that specifies whether the value of **dxfalC.iReadingOrder** MUST be ignored.
- e - flfntUser (1 bit):** A bit that specifies that the **number format** used is a user-defined **format string**. When set to 1, **dxffnum** contains a format string.
- f - unused2 (1 bit):** Undefined and MUST be ignored.
- g - fNewBorder (1 bit):** A bit that specifies how the **border** formats apply to a **range** of **cells**.

Value	Description
0	Border formats apply to all cells in the range.
1	Border formats only apply to the outline of the range.

For example, if the bit is set to 1 and there is a left border format, that left border format will only apply to the cells on the left edge of the range of cells.

reserved2 (12 bits): MUST be zero and MUST be ignored.

h - fZeroInited (1 bit): A bit that specifies whether the value of **dxfac.iReadingOrder** MUST be taken into account.

dxnum (variable): A [DXFNum](#) that specifies the number formatting. MUST exist if and only if **ibitAtrNum** is nonzero.

dxffntd (variable): A [DXFFntD](#) that specifies the font. MUST exist if and only if **ibitAtrFnt** is nonzero.

dxfac (8 bytes): A [DXFALC](#) that specifies the text alignment properties. MUST exist if and only if **ibitAtrAlc** is nonzero.

dxfbdr (8 bytes): A [DXFBdr](#) that specifies the border properties. MUST exist if and only if **ibitAtrBdr** is nonzero.

dxfpat (4 bytes): A [DXFPat](#) that specifies the pattern and colors. MUST exist if and only if **ibitAtrPat** is nonzero.

dxfprot (2 bytes): A [DXFProt](#) that specifies the **protection** attributes. MUST exist if and only if **ibitAtrProt** is nonzero.

2.5.96 DXFN12

The **DXFN12** structure specifies [differential formatting](#) and is an extension to [DXFN](#).

0	1	2	3	4	5	6	7	8	9	10	11	12	13	14	15	16	17	18	19	20	21	22	23	24	25	26	27	28	29	30	31
cbDxf																															
reserved (optional)																dxfn (variable)															
...																															
xfext (variable)																															
...																															

cbDxf (4 bytes): An unsigned integer that specifies the size of the structure in bytes. If greater than zero, it MUST be the total byte count of **dxfn** and **xfext**. Otherwise it MUST be zero.

reserved (2 bytes): MUST be zero and MUST be ignored. MUST be omitted when **cbDxf** is greater than zero.

dxfn (variable): A DXFN that specifies part of the differential formatting. MUST be omitted if **cbDxf** is 0x00000000.

xfext (variable): An [XFExtNoFRT](#) that specifies extensions for the differential formatting. MUST be omitted if **cbDxf** is equal to the byte count of **dxfn**.

2.5.97 DXFN12List

The **DXFN12List** structure specifies [differential formatting](#) used by [table block-level formatting](#). This structure also specifies extensions to the [DXFN](#) formatting properties.

0	1	2	3	4	5	6	7	8	9	10	11	12	13	14	15	16	17	18	19	20	21	22	23	24	25	26	27	28	29	30	31
dxfn (variable)																															
...																															
xfext (variable)																															
...																															

dxfn (variable): A DXFN structure that specifies differential formatting used by table block-level formatting.

xfext (variable): An [XFExtNoFRT](#) structure that specifies the set of extensions to the differential formatting properties specified in **dxfn**. MUST exist if and only if the size of this structure is greater than the size of the **dxfn** field.

2.5.98 DXFN12NoCB

The **DXFN12NoCB** structure specifies [differential formatting](#) and is an extension to [DXFN](#).

0	1	2	3	4	5	6	7	8	9	10	11	12	13	14	15	16	17	18	19	20	21	22	23	24	25	26	27	28	29	30	31
dxfn (variable)																															
...																															
xfext (variable)																															
...																															

dxfn (variable): A DXFN that specifies part of the differential formatting.

xfext (variable): An optional [XFExtNoFRT](#) that specifies extensions for the differential formatting.

2.5.99 DXFNum

The **DXFNum** structure specifies the **number format** in a containing [DXFN](#) structure. Its type depends on the **fFmtUser** field of DXFN

Value	Meaning
0	DXFNumIFmt
1	DXFNumUsr

2.5.100 DXFNumIFmt

The **DXFNumIFmt** structure specifies the number format in a containing [DXFN](#) structure when a format identifier is used.

0	1	2	3	4	5	6	7	8	9	10	11	12	13	14	15	16	17	18	19	20	21	22	23	24	25	26	27	28	29	30	31
unused										ifmt																					

unused (8 bits): Undefined and MUST be ignored.

ifmt (8 bits): An unsigned integer that specifies the identifier of the **number format** to use as specified in [IFmt](#).

2.5.101 DXFNumUsr

The **DXFNumUsr** structure specifies the **number format** in a containing [DXFN](#) structure when a **format string** is used.

0	1	2	3	4	5	6	7	8	9	10	11	12	13	14	15	16	17	18	19	20	21	22	23	24	25	26	27	28	29	30	31
cb																fmt (variable)															
...																															

cb (2 bytes): An unsigned integer that specifies the size of this structure, in bytes.

fmt (variable): An [XLUnicodeString](#) that specifies the number format to use as specified in the **stFormat** field of [Format](#).

2.5.102 DXFPat

The **DXFPat** structure specifies the **fill pattern** and color within a containing [DXFN](#) structure.

0	1	2	3	4	5	6	7	8	9	10	11	12	13	14	15	16	17	18	19	20	21	22	23	24	25	26	27	28	29	30	31
unused1										fls						icvForeground							icvBackground							A	

unused1 (10 bits): Undefined and MUST be ignored.

fls (6 bits): A [FillPattern](#) that specifies the fill pattern.

icvForeground (7 bits): An unsigned integer that specifies the color of the foreground of the cell. The value MUST be an [IcvXF](#) value. This value is unused and MUST be ignored if the **icvFNinch** field in the containing DXFN structure is 1.

icvBackground (7 bits): An unsigned integer that specifies the color of the background of the cell. The value MUST be an IcvXF value. This value is unused and MUST be ignored if the **icvBNinch** field in the containing DXFN structure is 1.

A - unused2 (2 bits): Undefined and MUST be ignored.

2.5.103 DXFProt

The **DXFProt** structure specifies the protection attributes inside a containing [DXFN](#) structure.

0	1	2	3	4	5	6	7	8	9	10	11	12	13	14	15	16	17	18	19	20	21	22	23	24	25	26	27	28	29	30	31
A	B	reserved																													

A - fLocked (1 bit): A bit that specifies if the **cell** content is locked when the **workbook** is protected.

B - fHidden (1 bit): A bit that specifies if the cell content is hidden when the workbook is protected.

reserved (14 bits): MUST be zero and MUST be ignored.

2.5.104 EnhancedProtection

The **EnhancedProtection** structure specifies protection settings for [Shared Features](#) of the Enhanced Protection type as specified by [SharedFeatureType.ISFPROTECTION](#). These settings apply to a protected **sheet**.

0	1	2	3	4	5	6	7	8	9	10	11	12	13	14	15	16	17	18	19	20	21	22	23	24	25	26	27	28	29	30	31
A	B	C	D	E	F	G	H	I	J	K	L	M	N	O	reserved																

A - iprotObjects (1 bit): A bit that specifies whether **linked objects** or **embedded objects** can be edited.

B - iprotScenarios (1 bit): A bit that specifies whether **scenarios** can be edited.

C - iprotFormatCells (1 bit): A bit that specifies whether **cells** can be formatted.

D - iprotFormatColumns (1 bit): A bit that specifies whether columns can be formatted.

E - iprotFormatRows (1 bit): A bit that specifies whether rows can be formatted.

F - iprotInsertColumns (1 bit): A bit that specifies whether columns can be inserted.

G - iprotInsertRows (1 bit): A bit that specifies whether rows can be inserted.

H - iprotInsertHyperlinks (1 bit): A bit that specifies whether **hyperlinks** can be inserted.

I - iprotDeleteColumns (1 bit): A bit that specifies whether columns can be deleted.

J - iprotDeleteRows (1 bit): A bit that specifies whether rows can be deleted.

K - iprotSelLockedCells (1 bit): A bit that specifies whether locked cells can be selected.

L - iprotSort (1 bit): A bit that specifies whether cells can be sorted.

M - iprotAutoFilter (1 bit): A bit that specifies whether cells can be filtered.

N - iprotPivotTables (1 bit): A bit that specifies whether [PivotTable](#) reports can be created or modified.

O - iprotSelUnlockedCells (1 bit): A bit that specifies whether unlocked cells can be selected.

reserved (17 bits): MUST be zero, and MUST be ignored.

2.5.105 ExternDdeLinkNoOper

The **ExternDdeLinkNoOper** structure specifies the data for a [DDE data item](#) in the [ExternName](#) record.

0	1	2	3	4	5	6	7	8	9	10	11	12	13	14	15	16	17	18	19	20	21	22	23	24	25	26	27	28	29	30	31
reserved																															
linkName (variable)																															
...																															

reserved (4 bytes): MUST be 0 and MUST be ignored.

linkName (variable): A [ShortXLUnicodeString](#) that specifies the DDE data item name. The value MUST be "StdDocumentName".

2.5.106 ExternDocName

The **ExternDocName** structure specifies the data for an [external defined name](#) in the [ExternName](#) record.

0	1	2	3	4	5	6	7	8	9	10	11	12	13	14	15	16	17	18	19	20	21	22	23	24	25	26	27	28	29	30	31
ixals																reserved															
extName (variable)																															
...																															
nameDefinition (variable)																															
...																															

ixals (2 bytes): If the external defined name specified by **extName** is a **local name**, this unsigned integer specifies a one-based index of an [XLUnicodestring](#) in the **rgst** field of the preceding [SupBook](#) record. The [XLUnicodestring](#) specifies the name of the sheet where the external defined name specified by **extName** is scoped. Otherwise this MUST be 0. The value MUST be less than or equal to the value of the **ctab** field in the preceding [SupBook](#) record.

reserved (2 bytes): MUST be zero, and MUST be ignored.

extName (variable): A [ShortXLUnicodeString](#) that specifies the name of the external defined name. **extName.cch** MUST be less than or equal to 255.

nameDefinition (variable): An [ExtNameParsedFormula](#) that specifies the formula (section [2.2.2](#)) of the external defined name.

2.5.107 ExternOleDdeLink

The **ExternOleDdeLink** structure specifies the data for an [OLE data item](#) or a [DDE data item](#) in the [ExternName](#) record. If the **fOleLink** field in the owned [ExternName](#) record is 1, the referenced item MUST be an OLE data item.

0	1	2	3	4	5	6	7	8	9	10	11	12	13	14	15	16	17	18	19	20	21	22	23	24	25	26	27	28	29	30	31
IStgName																															
linkName (variable)																															
...																															
moper (variable)																															
...																															

IStgName (4 bytes): An unsigned integer that specifies a [link storage](#) that specifies the linked **OLE** object. This name of the link storage MUST be the concatenation of "LNK" and the eight byte hexadecimal representation of this value. The value MUST be 0 for a DDE data item.

linkName (variable): A [ShortXLUnicodeString](#) that specifies the name of OLE data item or DDE data item. **linkName.cch** MUST be less than or equal to 255.

moper (variable): An optional [MOper](#) that specifies current **cell** values for the linked data. This field MUST exist if and only if

(byte size of owning [ExternName](#) record – 6 – byte size of **linkName** > 0).

2.5.108 ExtProp

The **ExtProp** structure specifies an extension to a formatting property.

0	1	2	3	4	5	6	7	8	9	10	11	12	13	14	15	16	17	18	19	20	21	22	23	24	25	26	27	28	29	30	31
extType																cb															
extPropData (variable)																															
...																															

extType (2 bytes): An unsigned integer that specifies the type of the extension. MUST be a value from the table as specified in the **extPropData** field.

cb (2 bytes): An unsigned integer that specifies the size of this ExtProp structure.

extPropData (variable): This field specifies the extension data. The size and data type of this field varies based on the property type as specified in **extType** as follows:

extType value	extPropData field Data and Meaning
0x0004	A FullColorExt that specifies the cell interior foreground color .
0x0005	A FullColorExt that specifies the cell interior background color .

extType value	extPropData field Data and Meaning
0x0006	An XFExtGradient that specifies a cell interior gradient fill .
0x0007	A FullColorExt that specifies the top cell border color.
0x0008	A FullColorExt that specifies the bottom cell border color.
0x0009	A FullColorExt that specifies the left cell border color.
0x000A	A FullColorExt that specifies the right cell border color.
0x000B	A FullColorExt that specifies the diagonal cell border color.
0x000D	A FullColorExt that specifies the cell text color.
0x000E	A 2-byte unsigned integer that specifies a FontScheme .
0x000F	A 2-byte unsigned integer that specifies the text indentation level . MUST be less than or equal to 250.

2.5.109 ExtRst

The **ExtRst** structure specifies **phonetic string** data.

0	1	2	3	4	5	6	7	8	9	10	1	2	3	4	5	6	7	8	9	20	1	2	3	4	5	6	7	8	9	30	1		
reserved										cb																							
phs																																	
rphssub (variable)																																	
...																																	
rgphruns (variable)																																	
...																																	

reserved (2 bytes): MUST be 1, and MUST be ignored.

cb (2 bytes): An unsigned integer that specifies the size, in bytes, of the phonetic string data.

phs (4 bytes): A [Phs](#) that specifies the formatting information for the phonetic string.

rphssub (variable): An [RPHSSub](#) that specifies the phonetic string.

rgphruns (variable): An array of [PhRuns](#). This specifies the **phonetic text runs**. Each PhRuns specifies a phonetic text run within **rphssub.st** that is displayed above a **text run** in the **rgb** field of the [XLUnicodeRichExtendedString](#) that contains this structure. The first character of the phonetic text run is the character specified by the **ichFirst** field of PhRuns. The first character in the **rgb** field of the XLUnicodeRichExtendedString that contains this structure that the phonetic text run appears earlier is specified by the **ichMom** field of PhRuns. Each **ichMom** field of a PhRuns in the array MUST be less than the **ichMom** field of the subsequent PhRuns in the array. Each **ichFirst** field of a PhRuns in the array MUST be less than the **ichFirst** of the subsequent PhRuns in the array. The sum of the **cchMom** fields of all PhRuns in the array MUST be less than or equal to the number of characters in **rgb** field of the XLUnicodeRichExtendedString that contains this structure. The number of elements in this array is **rphssub.crun**.

2.5.110 FactoidData

The **FactoidData** structure specifies information about a **smart tag**.

0	1	2	3	4	5	6	7	8	9	10	11	12	13	14	15	16	17	18	19	20	21	22	23	24	25	26	27	28	29	30	31
A	B	reserved						propertyBag (variable)																							
...																															

A - fDelete (1 bit): A bit that specifies whether the smart tag is deleted.

B - fXMLBased (1 bit): A bit that specifies whether the smart tag is **XML**-based. For more information about XML-based smart tags, see [\[MSDN-OSTD\]](#).

reserved (6 bits): MUST be 0, and MUST be ignored.

propertyBag (variable): A PropertyBag as defined in [\[MS-OSHARED\]](#) section 2.3.4.3 that specifies smart tag properties. Each entry in the PropertyBag is a pair of indexes into the **stringTable** field of the PropertyBagStore as defined in [\[MS-OSHARED\]](#) section 2.3.4.1 that specify the key/value pair representing a property of the smart tag.

2.5.111 Feat11CellStruct

The **Feat11CellStruct** structure specifies a **cell**.

0	1	2	3	4	5	6	7	8	9	10	11	12	13	14	15	16	17	18	19	20	21	22	23	24	25	26	27	28	29	30	31
idxRow																															
idxField																															

idxRow (4 bytes): An unsigned integer that specifies the row identifier of the row in the table. The row identifiers are stored in a table column with the **strName** of [Feat11FieldDataItem](#) equal to "ID". The row identifier specified in this field MUST match a row identifier stored in the **LISTDATA** element of the [List Data](#) stream. It MUST also match a row identifier stored in the **LISTSCHEMA** element of the List Data stream, under the Field node, where the "name" attribute of the Field node is equal to "ID".

idxField (4 bytes): An unsigned integer that specifies a column identifier. MUST be equal to the **idField** field of an item in the fielddata array of the containing [TableFeatureType](#) structure.

2.5.112 Feat11FdaAutoFilter

The **Feat11FdaAutoFilter** structure specifies the definition of an automatically generated **filter**, or **AutoFilter**.

0	1	2	3	4	5	6	7	8	9	10	11	12	13	14	15	16	17	18	19	20	21	22	23	24	25	26	27	28	29	30	31
cbAutoFilter																															
unused																recAutoFilter (variable)															
...																															

cbAutoFilter (4 bytes): An unsigned integer that specifies the size, in bytes, of the **recAutoFilter** field. MUST be less than or equal to 2080 bytes.

unused (2 bytes): Undefined and MUST be ignored.

recAutoFilter (variable): An [AutoFilter](#) structure that specifies the filter that is applied to the **table** column.

2.5.113 Feat11FieldDataItem

The **Feat11FieldDataItem** structure specifies a column of a **table**.

0	1	2	3	4	5	6	7	8	9	10	11	12	13	14	15	16	17	18	19	20	21	22	23	24	25	26	27	28	29	30	31
idField																															
Ifdt																															
Ifxidt																															
ilta																															
cbFmtAgg																															
istnAgg																															
A	B	C	D	E	F	G	H	I	J	K	unused2																				
cbFmtInsertRow																															
istnInsertRow																															
strFieldName (variable)																															
...																															
strCaption (variable)																															
...																															

dxFmtAgg (variable)
...
dxFmtInsertRow (variable)
...
AutoFilter (variable)
...
rgXmap (variable)
...
fmla (variable)
...
totalFmla (variable)
...
strTotal (variable)
...
wssInfo (variable)
...
qsif (optional)
dskHdrCache (variable)
...

idField (4 bytes): An unsigned integer that specifies the identifier of the column. MUST be nonzero and MUST be unique within the **FieldData** array in the containing [TableFeatureType](#) structure.

lfdt (4 bytes): An unsigned integer that specifies the column's Web based data provider data type. If the **It** field of the containing [TableFeatureType](#) structure is not set to 0x00000001, this field MUST be 0x00000000; otherwise it MUST be a value from the following table. For more information about the data types, see [\[MS-WSSTS\]](#) section 2.3.

Value	Web Based Data Provider Data Type
0x00000001	Text
0x00000002	Number

Value	Web Based Data Provider Data Type
0x00000003	Boolean
0x00000004	Date Time
0x00000005	Note
0x00000006	Currency
0x00000007	Lookup
0x00000008	Choice
0x00000009	URL
0x0000000A	Counter
0x0000000B	Multiple Choices

lfxidft (4 bytes): An unsigned integer that specifies the column's **XML** data type. If the **It** field of the containing TableFeatureType structure is not set to 0x00000002, this field **MUST** be 0x00000000; otherwise it **MUST** be a value from the following table. For more information about the data types, see [\[MSDN-SOM\]](#).

Value	MS-XML Data Type
0x00001000	SOMITEM_SCHEMA
0x00001001	SOMITEM_ATTRIBUTE
0x00001002	SOMITEM_ATTRIBUTEGROUP
0x00001003	SOMITEM_NOTATION
0x00001100	SOMITEM_IDENTITYCONSTRAINT
0x00001101	SOMITEM_KEY
0x00001102	SOMITEM_KEYREF
0x00001103	SOMITEM_UNIQUE
0x00002000	SOMITEM_ANYTYPE
0x00002100	SOMITEM_DATATYPE
0x00002101	SOMITEM_DATATYPE_ANYTYPE
0x00002102	SOMITEM_DATATYPE_ANYURI
0x00002103	SOMITEM_DATATYPE_BASE64BINARY
0x00002104	SOMITEM_DATATYPE_BOOLEAN
0x00002105	SOMITEM_DATATYPE_BYTE
0x00002106	SOMITEM_DATATYPE_DATE
0x00002107	SOMITEM_DATATYPE_DATETIME

Value	MS-XML Data Type
0x00002108	SOMITEM_DATATYPE_DAY
0x00002109	SOMITEM_DATATYPE_DECIMAL
0x0000210A	SOMITEM_DATATYPE_DOUBLE
0x0000210B	SOMITEM_DATATYPE_DURATION
0x0000210C	SOMITEM_DATATYPE_ENTITIES
0x0000210D	SOMITEM_DATATYPE_ENTITY
0x0000210E	SOMITEM_DATATYPE_FLOAT
0x0000210F	SOMITEM_DATATYPE_HEXBINARY
0x00002110	SOMITEM_DATATYPE_ID
0x00002111	SOMITEM_DATATYPE_IDREF
0x00002112	SOMITEM_DATATYPE_IDREFS
0x00002113	SOMITEM_DATATYPE_INT
0x00002114	SOMITEM_DATATYPE_INTEGER
0x00002115	SOMITEM_DATATYPE_LANGUAGE
0x00002116	SOMITEM_DATATYPE_LONG
0x00002117	SOMITEM_DATATYPE_MONTH
0x00002118	SOMITEM_DATATYPE_MONTHDAY
0x00002119	SOMITEM_DATATYPE_NAME
0x0000211A	SOMITEM_DATATYPE_NCNAME
0x0000211B	SOMITEM_DATATYPE_NEGATIVEINTEGER
0x0000211C	SOMITEM_DATATYPE_NMTOKEN
0x0000211D	SOMITEM_DATATYPE_NMTOKENS
0x0000211E	SOMITEM_DATATYPE_NONNEGATIVEINTEGER
0x0000211F	SOMITEM_DATATYPE_NONPOSITIVEINTEGER
0x00002120	SOMITEM_DATATYPE_NORMALIZEDSTRING
0x00002121	SOMITEM_DATATYPE_NOTATION
0x00002122	SOMITEM_DATATYPE_POSITIVEINTEGER
0x00002123	SOMITEM_DATATYPE_QNAME
0x00002124	SOMITEM_DATATYPE_SHORT
0x00002125	SOMITEM_DATATYPE_STRING
0x00002126	SOMITEM_DATATYPE_TIME
0x00002127	SOMITEM_DATATYPE_TOKEN

Value	MS-XML Data Type
0x00002128	SOMITEM_DATATYPE_UNSIGNEDBYTE
0x00002129	SOMITEM_DATATYPE_UNSIGNEDINT
0x0000212A	SOMITEM_DATATYPE_UNSIGNEDLONG
0x0000212B	SOMITEM_DATATYPE_UNSIGNEDSHORT
0x0000212C	SOMITEM_DATATYPE_YEAR
0x0000212D	SOMITEM_DATATYPE_YEARMONTH
0x000021FF	SOMITEM_DATATYPE_ANYSIMPLETYPE
0x00002200	SOMITEM_SIMPLETYPE
0x00002400	SOMITEM_COMPLEXTYPE
0x00004000	SOMITEM_PARTICLE
0x00004001	SOMITEM_ANY
0x00004002	SOMITEM_ANYATTRIBUTE
0x00004003	SOMITEM_ELEMENT
0x00004100	SOMITEM_GROUP
0x00004101	SOMITEM_ALL
0x00004102	SOMITEM_CHOICE
0x00004103	SOMITEM_SEQUENCE
0x00004104	SOMITEM_EMPTYPARTICLE
0x00000800	SOMITEM_NULL
0x00002800	SOMITEM_NULL_TYPE
0x00004801	SOMITEM_NULL_ANY
0x00004802	SOMITEM_NULL_ANYATTRIBUTE
0x00004803	SOMITEM_NULL_ELEMENT

ilta (4 bytes): An unsigned integer that specifies the **aggregation function** to use for the **total row** of the column. MUST be a value from the following table:

Value	Aggregation Formula
0x00000000	No formula (section 2.2.2)
0x00000001	Average
0x00000002	Count
0x00000003	Count Numbers
0x00000004	Max

Value	Aggregation Formula
0x00000005	Min
0x00000006	Sum
0x00000007	Standard Deviation
0x00000008	Variance
0x00000009	Custom formula<164>

cbFmtAgg (4 bytes): An unsigned integer that specifies the size, in bytes, of the **dxFmtAgg** field.

istnAgg (4 bytes): An unsigned integer that specifies the zero-based index of the **Style** record in the **Globals Substream ABNF** that is used for the total row of the column. If this value equals 0xFFFFFFFF, the total row of the column uses built-in **table styles**.

A - fAutoFilter (1 bit): A bit that specifies whether the column has an **AutoFilter**.

B - fAutoFilterHidden (1 bit): A bit that specifies whether the column has an AutoFilters that is not displayed. When this field is set to 1, **fAutoFilter** MUST be set to 1.

C - fLoadXmap (1 bit): A bit that specifies whether the **rgXmap** field is present. MUST be 0 if the **It** field of the containing TableFeatureType structure is not equal to 0x00000002.

D - fLoadFmla (1 bit): A bit that specifies whether the **fmla** field is present for a table whose **data source** is a Web based data provider list. MUST be 0 if the **It** field of the containing TableFeatureType structure is not equal to 0x00000001.

E - unused1 (2 bits): Undefined, and MUST be ignored.

F - reserved2 (1 bit): MUST be zero, and MUST be ignored.

G - fLoadTotalFmla (1 bit): A bit that specifies whether the **totalFmla** field is present. SHOULD<165> be 1 if **ilta** is 0x00000009, MUST be 0 otherwise.

H - fLoadTotalArray (1 bit): A bit that specifies whether the formula specified by **totalFmla** is an array formula. MUST be 0 when **fLoadTotalFmla** is 0.

I - fSaveStyleName (1 bit): A bit that specifies whether the **dskHdrCache.strStyleName** field is present.

J - fLoadTotalStr (1 bit): A bit that specifies whether the **strTotal** field is present. MUST be 0 when **ilta** is not 0x00000000.

K - fAutoCreateCalcCol (1 bit): A bit that specifies whether the column has a calculated column formula. MUST be 0 if the **It** field of the containing TableFeatureType structure is set to 0x00000001.

unused2 (20 bits): Undefined, and MUST be ignored.

cbFmtInsertRow (4 bytes): An unsigned integer that specifies the size, in bytes, of the **dxFmtInsertRow** field.

istnInsertRow (4 bytes): An unsigned integer that specifies the zero-based index of the **Style** record in the **Globals Substream ABNF** that is used for the **insert row** of the column. If this value equals 0xFFFFFFFF, the insert row of the column uses built-in table styles.

strFieldName (variable): An [XLUnicodeString](#) that specifies the name of the column, as provided by the data source. MUST contain at least one character and less than or equal to 255 characters. MUST be unique within the **FieldData** array in the containing TableFeatureType structure if the **It** field of the containing TableFeatureType structure is set to 0x00000001 or 0x00000003.

strCaption (variable): An XLUnicodeString that specifies the caption of the column. MUST contain at least one character and less than or equal to 255 characters. MUST be unique within the **FieldData** array in the containing TableFeatureType structure. MUST be equal to the value within the header **cell** at the location of the column title if the **crwHeader** field of the containing TableFeatureType structure is greater than 0. This field is present if and only if the **fSingleCell** field of the containing TableFeatureType structure is set to 0. MUST NOT contain the characters from the following table:

Invalid Characters	Unicode range
Lower control characters	0x0000-0x0031
Invalid Unicode surrogate pairs	High surrogate with a value of 0xD800 to 0xDBFF followed by a low surrogate with a value of 0xDC00 to 0xDFFF.
Reserved characters	0xFFFE, 0xFFFF, 0xF00B

dxFmtAgg (variable): A [DXFN12List](#) that specifies the formatting of the total row of the column, if different from the **style** specified by **istnAgg** or built-in table styles. This field is present if and only if the **cbFmtAgg** field is greater than 0x00000000.

dxFmtInsertRow (variable): A [DXFN12List](#) that specifies the formatting of the insert row of the column, if different from the style specified by **istnInsertRow** or built-in table styles. This field is present if and only if the **cbFmtInsertRow** field is more than 0x00000000.

AutoFilter (variable): A [Feat11FdaAutoFilter](#) that specifies the characteristics of the AutoFilter for the column. This field is present if and only if the **fAutoFilter** field of the containing TableFeatureType structure is set to 1.

rgXmap (variable): A [Feat11XMap](#) structure that specifies the mapping to the column data within an XML data source. This field is present if and only if the **fLoadXmapi** bit is set to 1.

fmla (variable): A [Feat11Fmla](#) structure that specifies the **column formula** whose data source is a Web based data provider list. The specified formula applies to every row of the column, except the total row and the **header row**. This field is present if and only if the **fLoadFmla** bit is set to 1.

totalFmla (variable): A [Feat11TotalFmla](#) structure that specifies the formula to use for the total row of the column. This field is present if and only if the **fLoadTotalFmla** bit is set to 1.

strTotal (variable): An XLUnicodeString structure that specifies the text to use for the total row of the column. MUST contain less than or equal to 32767 characters. This field is present if and only if the **fLoadTotalStr** bit is set to 1.

wssInfo (variable): A [Feat11WSSListInfo](#) that specifies the relationship between the column and a Web based data provider list. This field is present if and only if the **It** field of the containing TableFeatureType structure is set to 0x00000001.

qsif (4 bytes): An unsigned integer that specifies the relationship between the column and its Microsoft Query data source. MUST be equal to the **idField** field of a [Qsif](#) record within the [Worksheet Substream](#). This field is present if and only if the **It** field of the containing TableFeatureType structure is set to 0x00000003 (External data source). MUST be greater than zero and MUST be unique within the **FieldData** array in the containing TableFeatureType structure.

dskHdrCache (variable): A [CachedDiskHeader](#) that specifies the column header formatting information. This field is present if and only if the **crwHeader** field of the containing TableFeatureType structure is set to 0x0000 and the **fSingleCell** field of the containing TableFeatureType structure is set to 0.

2.5.114 Feat11Fmla

The **Feat11Fmla** structure specifies a formula (section [2.2.2](#)) that is used as a **column formula**.

0	1	2	3	4	5	6	7	8	9	10	11	12	13	14	15	16	17	18	19	20	21	22	23	24	25	26	27	28	29	30	31
cbFmla																rgbFmla (variable)															
...																															

cbFmla (2 bytes): An unsigned integer that specifies the size, in bytes, of the **rgbFmla** field.

rgbFmla (variable): A [ListParsedFormula](#) that specifies the [parsed expression](#) of the column formula.

2.5.115 Feat11RgInvalidCells

The **Feat11RgInvalidCells** structure specifies the **cells** in a **table** linked to a Web-based **data provider data source** which could not be synchronized.

0	1	2	3	4	5	6	7	8	9	10	11	12	13	14	15	16	17	18	19	20	21	22	23	24	25	26	27	28	29	30	31
cCellInvalid																rgCellInvalid (variable)															
...																															

cCellInvalid (2 bytes): An unsigned integer that specifies the number of items in the **rgCellInvalid** field.

rgCellInvalid (variable): An array of [Feat11CellStruct](#) that specifies the cells that could not be synchronized with a Web-based data provider data source.

2.5.116 Feat11RgSharepointIdChange

The **Feat11RgSharepointIdChange** structure specifies the identifier of modified rows in a **table** linked to a Web-based **data provider**. This information is used when synchronizing between the local copy of the table, and the Web-based data provider.

0	1	2	3	4	5	6	7	8	9	10	11	12	13	14	15	16	17	18	19	20	21	22	23	24	25	26	27	28	29	30	31
cId																rgId (variable)															
...																															

cId (2 bytes): An unsigned integer that specifies the number of elements in **rgId**.

rgId (variable): An array of 4-byte unsigned integers that specifies identifiers of rows that were modified. The length of the array is specified by the **cId** field, and each entry of the array specifies the identifier of one row. The row identifier specified in this field MUST match a row identifier stored in the **LISTDATA** element of the [List Data](#) stream, as well as the row identifier stored in the column with a title "ID" in the table.

2.5.117 Feat11RgSharepointIdDel

The **Feat11RgSharepointIdDel** structure specifies the identifier of deleted rows in a **table** linked to a Web-based **data provider**. This information is used when synchronizing between the local copy of the table, and the Web-based data provider.

0	1	2	3	4	5	6	7	8	9	10	1	2	3	4	5	6	7	8	9	20	1	2	3	4	5	6	7	8	9	30	1		
cId											rgId (variable)																						
...																																	

cId (2 bytes): An unsigned integer that specifies the number of elements in **rgId**.

rgId (variable): An array of 4-byte unsigned integers that specifies identifiers of rows that were deleted. The length of the array is specified by the **cId** field, and each entry of the array specifies the identifier of one row. The row identifier specified in this field MUST match a row identifier stored in the **LISTDATA** element of the [List Data](#) stream.

2.5.118 Feat11TotalFmla

The **Feat11TotalFmla** structure specifies a formula (section [2.2.2](#)) that can be used as a **total row** formula [<166>](#).

0	1	2	3	4	5	6	7	8	9	10	1	2	3	4	5	6	7	8	9	20	1	2	3	4	5	6	7	8	9	30	1		
rgbFmlaTotal (variable)																																	
...																																	

rgbFmlaTotal (variable): A [ListParsedFormula](#) or [ListParsedArrayFormula](#) that specifies the [parsed expression](#) of the total row formula. When the **fLoadTotalArray** field of the containing [Feat11FieldDataItem](#) structure is set to 1, this field is a [ListParsedArrayFormula](#); otherwise, it is a [ListParsedFormula](#).

2.5.119 Feat11WSSListInfo

The **Feat11WSSListInfo** structure specifies the relationship between a table column and a Web-based **data provider** list.

0	1	2	3	4	5	6	7	8	9	10	11	12	13	14	15	16	17	18	19	20	21	22	23	24	25	26	27	28	29	30	31
LCID																															
cDec																															
A	B	C	D	E	F	G	unused1																								
H	I	J	K	L	M	N	O	bDefaultType												unused2											
rgbDV (variable)																															
...																															
strFormula (variable)																															
...																															
reserved																															

LCID (4 bytes): An unsigned integer that specifies the **language code identifier (LCID)** of the source data.

cDec (4 bytes): An unsigned integer that specifies the number of decimal places for a numeric column.

A - fPercent (1 bit): A bit that specifies whether the numeric values in the column are displayed as percentages.

B - fDecSet (1 bit): A bit that specifies whether the numeric values in the column are displayed with a fixed decimal point. The position of the decimal point is specified by the **cDec** field.

C - fDateOnly (1 bit): A bit that specifies whether only the date part of date/time values is displayed.

D - fReadingOrder (2 bits): An unsigned integer that specifies the **reading order**. MUST be a value from the following table:

Value	Meaning
0x0	Reading order is determined by the application based on the reading order of the cells surrounding the table.
0x1	Reading order is left-to-right .
0x2	Reading order is right-to-left .

E - fRichText (1 bit): A bit that specifies whether the column contains rich text.

F - fUnkRTFormatting (1 bit): A bit that specifies whether the column contains unrecognized rich text formatting.

G - fAlertUnkRTFormatting (1 bit): A bit that specifies whether the column contains unrecognized rich text formatting that requires notifying the user.

unused1 (24 bits): Undefined and MUST be ignored.

H - fReadOnly (1 bit): A bit that specifies whether the column is read only.

I - fRequired (1 bit): A bit that specifies whether every item in this column has to contain data.

J - fMinSet (1 bit): A bit that specifies whether a minimum numeric value for the column exists. The minimum value is stored in the [List Data](#) stream within the LISTSCHEMA element, under the Field node's Min attribute.

K - fMaxSet (1 bit): A bit that specifies whether a maximum numeric value for the column exists. The maximum value is stored in the List Data stream within the LISTSCHEMA element, under the Field node's Max attribute.

L - fDefaultSet (1 bit): A bit that specifies whether there is a default value for the column.

M - fDefaultDateToday (1 bit): A bit that specifies whether the default value for the column is the current date.

N - fLoadFormula (1 bit): A bit that specifies whether a validation formula exists for this column. The formula is specified by the **strFormula** field.

O - fAllowFillIn (1 bit): A bit that specifies whether a choice field allows custom user entries.

bDefaultValue (8 bits): An unsigned integer that specifies the type of the **rgbDV** default value. This field MUST be ignored if **fDefaultSet** is not 0x1; otherwise, it MUST be a value from the following table:

Value	Meaning
0x00	There is no default value specified.
0x01	rgbDV is a string.
0x02	rgbDV is a Boolean.
0x03	rgbDV is a number.

unused2 (16 bits): Undefined, MUST be ignored.

rgbDV (variable): A field of variable data type that specifies the default value for the column. The data type is specified in the **lfdt** field of the containing [Feat11FieldDataItem](#) structure. MUST be one of the data types specified in the following table:

lfdt of the containing Feat11FieldDataItem	Data Type	rgbDV data type and meaning
0x00000001	Short Text	An XLUnicodeString with a maximum length of 255 Unicode characters.
0x00000002	Number	An Xnum (section 2.5.342).
0x00000003	Yes/No	A 32-bit Boolean (section 2.5.14).
0x00000004	Date time	A DateAsNum .
0x00000005	Invalid	rgbDV does not exist.
0x00000006	Currency	An Xnum.
0x00000007	Invalid	rgbDV does not exist.
0x00000008	Choice	An XLUnicodeString with a maximum length of 255 Unicode characters.

fldt of the containing Feat11FieldDataItem	Data Type	rgbDV data type and meaning
0x00000009	Invalid	rgbDV does not exist.
0x0000000A	Invalid	rgbDV does not exist.
0x0000000B	Multi-choice	An XLUnicodeString with a maximum length of 255 Unicode characters.

strFormula (variable): An XLUnicodeString that specifies the validation formula as defined by the Web based data provider. This field exists if and only if **fLoadFormula** is set to 0x1.

reserved (4 bytes): MUST be 0x00000000, and MUST be ignored.

2.5.120 Feat11XMap

The **Feat11XMap** structure specifies the mapping between a table column's data and an XML **data source**.

0	1	2	3	4	5	6	7	8	9	10	1	2	3	4	5	6	7	8	9	20	1	2	3	4	5	6	7	8	9	30	1
iXmapMac										rgXmap (variable)																					
...																															

iXmapMac (2 bytes): An unsigned integer that specifies the number of items in the **rgXmap** array. MUST be less than or equal to 0x0001.

rgXmap (variable): An array of [Feat11XMapEntry](#) that specifies the mapping between the current table column and an XML data source. The number of items in **rgXmap** MUST be equal to **iXmapMac**.

2.5.121 Feat11XMapEntry

The **Feat11XMapEntry** structure specifies a mapping to an XML **data source**.

0	1	2	3	4	5	6	7	8	9	10	1	2	3	4	5	6	7	8	9	20	1	2	3	4	5	6	7	8	9	30	1
A	B	C	D	reserved3																											
details (variable)																															
...																															

A - reserved1 (1 bit): MUST be zero, and MUST be ignored.

B - fLoadXMap (1 bit): MUST be 1, and MUST be ignored.

C - fCanBeSingle (1 bit): A bit that specifies whether **details.rgbXPath** resolves to a single **XML node** or a collection of XML nodes. This field MUST be a value from the following table:

Value	Meaning
0	Specifies that details.rgbXPath resolves to a collection of XML nodes.
1	Specifies that details.rgbXPath resolves to a single XML node.

D - reserved2 (1 bit): MUST be zero, and MUST be ignored.

reserved3 (28 bits): MUST be zero, and MUST be ignored.

details (variable): A [Feat11XMapEntry2](#) that specifies the mapping between the data and the XML data source.

2.5.122 Feat11XMapEntry2

The **Feat11XMapEntry2** structure specifies the mapping to an **XML data source**.

0	1	2	3	4	5	6	7	8	9	10	11	12	13	14	15	16	17	18	19	20	21	22	23	24	25	26	27	28	29	30	31
dwMapId																															
rgbXPath (variable)																															
...																															

dwMapId (4 bytes): An unsigned integer that specifies the **XML schema** associated with this **table** column. The value MUST equal the value of the **ID** attribute of a **Map** element contained within the **XML stream** (section [2.1.7.22](#)).

rgbXPath (variable): An [XLUnicodeString](#) that contains the **XPath expression** that specifies the mapped element in the XML schema specified by **dwMapId**. The length of this string MUST be less than 32000.

2.5.123 FeatFormulaErr2

The **FeatFormulaErr2** structure specifies formula evaluation information for a [Shared Feature](#) of type ISFFEC2 as specified in [SharedFeatureType](#).

0	1	2	3	4	5	6	7	8	9	10	11	12	13	14	15	16	17	18	19	20	21	22	23	24	25	26	27	28	29	30	31
grffecIgnore																															

grffecIgnore (4 bytes): A [FFErrorCheck](#) that specifies the type of errors that will be ignored.

2.5.124 FeatProtection

The **FeatProtection** structure specifies data for a [shared feature](#).

0	1	2	3	4	5	6	7	8	9	10	11	12	13	14	15	16	17	18	19	20	21	22	23	24	25	26	27	28	29	30	31
A	reserved																														
wPassword																															
stTitle (variable)																															
...																															
sdContainer (variable)																															
...																															

A - fSD (1 bit): A bit that specifies whether this structure contains self-relative **security descriptor** data. For more information about self-relative security descriptors see [\[MSDN-ASRSD\]](#).

reserved (31 bits): MUST be zero, and MUST be ignored.

wPassword (4 bytes): An unsigned integer that specifies the verifier for the password required to edit the referenced **ranges** of a **protected sheet**. A value of zero indicates that the password is empty. The algorithm to generate the password verifier is documented in the [password verifier algorithm](#).

stTitle (variable): An [XLUnicodeString](#) that specifies the title for this **protection** feature.

sdContainer (variable): An [SDContainer](#) that specifies security information that identifies who can edit the referenced ranges of a protected sheet without needing a password.

2.5.125 FeatSmartTag

The **FeatSmartTag** structure specifies data for a [Shared Feature](#) of type ISFFACTOID as described in [SharedFeatureType](#).

0	1	2	3	4	5	6	7	8	9	10	11	12	13	14	15	16	17	18	19	20	21	22	23	24	25	26	27	28	29	30	31
hashValue																															
cSmartTags										rgFactoid (variable)																					
...																															

hashValue (4 bytes): An unsigned integer that specifies a **hash** value for the string representation of the content of a **cell**. This hash value is used to detect cell changes with the purpose of validating, updating or removing the **smart tags** associated with the cell. If the string representation of the cell content is the empty string, **hashValue** MUST be 0; otherwise, **hashValue** MUST be computed using the following algorithm:

```

SET hashValue to zero
FOR each byteValue (1-byte unsigned integer) in the input string
  Bitwise shift hashValue to the left by 4 and add byteValue
  SET overflow (4-byte unsigned integer) to the bitwise AND of hashValue and 0xF0000000
  IF overflow is not zero THEN

```

```

        SET the most significant 4 bits of hashValue to zero
        Bitwise shift overflow to the right by 24
        SET hashValue to XOR of hashValue and overflow
    END IF
END FOR
IF hashValue is zero
    SET hashValue to 1
END IF

```

cSmartTags (1 byte): An unsigned integer that specifies the number of items in the **rgFactoid** array.

rgFactoid (variable): An array of [FactoidData](#). Each element specifies data for a smart tag.

2.5.126 FFErorCheck

The **FFErrorCheck** structure specifies the types of error conditions that can be checked in a formula evaluation for a [Shared Feature](#).

0	1	2	3	4	5	6	7	8	9	10	11	12	13	14	15	16	17	18	19	20	21	22	23	24	25	26	27	28	29	30	31
A	B	C	D	E	F	G	H	reserved																							

A - ffecCalcError (1 bit): A bit that specifies whether to check for calculation errors.

B - ffecEmptyCellRef (1 bit): A bit that specifies whether to check for references to empty cells.

C - ffecNumStoredAsText (1 bit): A bit that specifies whether to check the format of numeric values.

D - ffecInconsistRange (1 bit): A bit that specifies whether to check formulas in the **range** of the shared feature with references to less than the entirety of a range containing continuous data.

E - ffecInconsistFmla (1 bit): A bit that specifies whether to check formulas in the range of the shared feature that are inconsistent with formulas in neighboring cells.

F - ffecTextDateInsuff (1 bit): A bit that specifies whether to check the format of date/time values.

G - ffecUnprotFmla (1 bit): A bit that specifies whether to check for unprotected formulas.

H - ffecDataValidation (1 bit): A bit that specifies whether to perform data validation.

reserved (24 bits): MUST be zero, and MUST be ignored.

2.5.127 FillPattern

The **FillPattern** enumeration specifies the **fill pattern**.[<167>](#)

Name	Value	Meaning
FLSNUL	0x00	No fill pattern
FLSSOLID	0x01	Solid
FLSMEDGRAY	0x02	50% gray
FLSDKGRAY	0x03	75% gray

Name	Value	Meaning
FLSLTGRAY	0x04	25% gray
FLSDKHOR	0x05	Horizontal stripe
FLSDKVER	0x06	Vertical stripe
FLSDKDOWN	0x07	Reverse diagonal stripe
FLSDKUP	0x08	Diagonal stripe
FLSDKGRID	0x09	Diagonal crosshatch
FLSDKTRELLIS	0x0A	Thick Diagonal crosshatch
FLSLTHOR	0x0B	Thin horizontal stripe
FLSLTVER	0x0C	Thin vertical stripe
FLSLTDOWN	0x0D	Thin reverse diagonal stripe
FLSLTUP	0x0E	Thin diagonal stripe
FLSLTGRID	0x0F	Thin horizontal crosshatch
FLSLTTRELLIS	0x10	Thin diagonal crosshatch
FLSGRAY125	0x11	12.5% gray
FLSGRAY0625	0x12	6.25% gray

2.5.128 FillStylePropertiesForShapePropsStreamChecksum

The **FillStylePropertiesForShapePropsStreamChecksum** structure specifies the fill-style data used to compute the **checksum** of the [ShapePropsStream](#) record.

The related [GelFrame](#) record referenced in the following field specifications is the GelFrame record that exists along with the ShapePropsStream record in one of the following sets of records.

- A sequence of records that conforms to the [FRAME](#) rule.
- A sequence of records that conforms to the DROPBAR rule.
- A sequence of records that conforms to the AXS rule if the **wObjContext** field in the ShapePropsStream record is equal to 0x0003.
- A sequence of records that conforms to the SS rule. If multiple ShapePropsStream records exist in the set, then the ShapePropsStream record related to the GelFrame record **MUST** contain a **wObjContext** field value equal to 0x0001. If a single ShapePropsStream record exists in the set, it is related to the GelFrame record.

0	1	2	3	4	5	6	7	8	9	10	11	12	13	14	15	16	17	18	19	20	21	22	23	24	25	26	27	28	29	30	31
fillTypeOpid																															
fillType																															
fillColorOpid																															

fillColor
fillOpacityOpid
fillOpacity
fillBackColorOpid
fillBackColor
fillBackOpacityOpid
fillBackOpacity
fillCrModOpid
fillCrMod
fillBlipOpid
fillBlip
fillBlip_complex_md4uid (16 bytes)
...
...
fillBlipNameOpid
fillBlipName
fillBlipName_complex (variable)
...
fillBlipFlagsOpid
fillBlipFlags
fillWidthOpid
fillWidth
fillHeightOpid
fillHeight
fillAngleOpid

fillAngle
fillFocusOpid
fillFocus
fillToLeftOpid
fillToLeft
fillToTopOpid
fillToTop
fillToRightOpid
fillToRight
fillToBottomOpid
fillToBottom
fillRectLeftOpid
fillRectLeft
fillRectTopOpid
fillRectTop
fillRectRightOpid
fillRectRight
fillRectBottomOpid
fillRectBottom
fillDztypeOpid
fillDztype
fillShadePresetOpid
fillShadePreset
fillShadeColorsOpid
fillShadeColors

fillShadeColors_complex (variable)
...
fillOriginXOpid
fillOriginX
fillOriginYOpid
fillOriginY
fillShapeOriginXOpid
fillShapeOriginX
fillShapeOriginYOpid
fillShapeOriginY
fillShadeTypeOpid
fillShadeType
fillColorExtOpid
fillColorExt
reserved415Opid
reserved1
fillColorExtModOpid
fillColorExtMod
reserved417Opid
reserved2
fillBackColorExtOpid
fillBackColorExt
reserved419Opid
reserved3
fillBackColorExtModOpid

fillBackColorExtMod
reserved421Opid
reserved4
reserved422Opid
reserved5
reserved423Opid
reserved6
fillstyle_fFilledOpid
fillstyle_fFilled
fillstyle_ffillShapeOpid
fillstyle_ffillShape
fillstyle_ffillUseRectOpid
fillstyle_ffillUseRect

fillTypeOpid (4 bytes): An unsigned integer that specifies the identifier of the fillType property. MUST be 0x0180, which is the same value as the **opid.opid** field of the fillType property as specified in [\[MS-ODRAW\]](#) section 2.3.7.1.

fillType (4 bytes): An unsigned integer that specifies the fillType property. MUST equal the value specified by the **fillType** field of the related GelFrame record or the default value if the field is not present in the GelFrame record.

fillColorOpid (4 bytes): An unsigned integer that specifies the identifier of the fillColor property. MUST be 0x0181, which is the same value as the **opid.opid** field of the fillColor property as specified in [\[MS-ODRAW\]](#) section 2.3.7.2.

fillColor (4 bytes): An unsigned integer that specifies the fillColor property. MUST equal the value specified by the **fillColor** field of the related GelFrame record or the default value if the field is not present in the GelFrame record.

fillOpacityOpid (4 bytes): An unsigned integer that specifies the identifier of the fillOpacity property. MUST be 0x0182, which is the same value as the **opid.opid** field of the fillOpacity property as specified in [\[MS-ODRAW\]](#) section 2.3.7.3.

fillOpacity (4 bytes): An unsigned integer that specifies the fillOpacity property. MUST equal the value specified by the **fillOpacity** field of the related GelFrame record or the default value if the field is not present in the GelFrame record.

fillBackColorOpid (4 bytes): An unsigned integer that specifies the identifier of the fillBackColor property. MUST be 0x0183, which is the same value as the **opid.opid** field of the fillBackColor property as specified in [\[MS-ODRAW\]](#) section 2.3.7.4.

fillBackColor (4 bytes): An unsigned integer that specifies the fillBackColor property. MUST equal the value specified by the **fillBackColor** field of the related GelFrame record or the default value if the field is not present in the GelFrame record.

fillBackOpacityOpid (4 bytes): An unsigned integer that specifies the identifier of the fillBackOpacity property. MUST be 0x0184, which is the same value as the **opid.opid** field of the fillBackOpacity property as specified in [MS-ODRAW] section 2.3.7.5.

fillBackOpacity (4 bytes): An unsigned integer that specifies the fillBackOpacity property. MUST equal the value specified by the **fillBackOpacity** field of the related GelFrame record or the default value if the field is not present in the GelFrame record.

fillCrModOpid (4 bytes): An unsigned integer that specifies the identifier of the fillCrMod property. MUST be 0x0185, which is the same value as the **opid.opid** field of the fillCrMod property as specified in [MS-ODRAW] section 2.3.7.6.

fillCrMod (4 bytes): An unsigned integer that specifies the fillCrMod property. MUST equal the value specified by the **fillCrMod** field of the related GelFrame record or the default value if the field is not present in the GelFrame record.

fillBlipOpid (4 bytes): An unsigned integer that specifies the identifier of the fillBlip property. MUST be 0x0186, which is the same value as the **opid.opid** field of the fillBlip property as specified in [MS-ODRAW] section 2.3.7.7.

fillBlip (4 bytes): An unsigned integer that specifies the fillBlip property. MUST equal the value specified by the **fillBlip** field of the related GelFrame record or the default value if the field is not present in the GelFrame record.

fillBlip_complex_md4uid (16 bytes): An MD4 digest, as specified in [\[RFC1320\]](#), that MUST equal the value specified by the **fillBlip_complex.rgbUid1** field of the related GelFrame record. This field MUST be present when **fillBlip** is greater than zero. MUST NOT be present when **fillBlip** is zero.

fillBlipNameOpid (4 bytes): An unsigned integer that specifies the identifier of the fillBlipName property. MUST be 0x0187, which is the same value as the **opid.opid** field of the fillBlipName property as specified in [MS-ODRAW] section 2.3.7.9.

fillBlipName (4 bytes): An unsigned integer that specifies the fillBlipName property. MUST equal the value specified by the **fillBlipName** field of the related GelFrame record or the default value if the field is not present in the GelFrame record.

fillBlipName_complex (variable): A Unicode null-terminated string that MUST equal the value specified by the **fillBlipName_complex** field of the related GelFrame record. This field MUST be present when **fillBlipName** is greater than zero. MUST NOT be present when **fillBlipName** is zero.

fillBlipFlagsOpid (4 bytes): An unsigned integer that specifies the identifier of the fillBlipFlags property. MUST be 0x0188, which is the same value as the **opid.opid** field of the fillBlipFlags property as specified in [MS-ODRAW] section 2.3.7.11.

fillBlipFlags (4 bytes): An unsigned integer that specifies the fillBlipFlags property. MUST equal the value specified by the **fillBlipFlags** field of the related GelFrame record or the default value if the field is not present in the GelFrame record.

fillWidthOpid (4 bytes): An unsigned integer that specifies the identifier of the fillWidth property. MUST be 0x0189, which is the same value as the **opid.opid** field of the fillWidth property as specified in [MS-ODRAW] section 2.3.7.12.

fillWidth (4 bytes): An unsigned integer that specifies the fillWidth property. MUST equal the value specified by the **fillWidth** field of the related GelFrame record or the default value if the field is not present in the GelFrame record.

fillHeightOpid (4 bytes): An unsigned integer that specifies the identifier of the fillHeight property. MUST be 0x018A, which is the same value as the **opid.opid** field of the fillHeight property as specified in [MS-ODRAW] section 2.3.7.13.

fillHeight (4 bytes): An unsigned integer that specifies the fillHeight property. MUST equal the value specified by the **fillHeight** field of the related GelFrame record or the default value if the field is not present in the GelFrame record.

fillAngleOpid (4 bytes): An unsigned integer that specifies the identifier of the fillAngle property. MUST be 0x018B, which is the same value as the **opid.opid** field of the fillAngle property as specified in [MS-ODRAW] section 2.3.7.14.

fillAngle (4 bytes): An unsigned integer that specifies the fillAngle property. MUST equal the value specified by the **fillAngle** field of the related GelFrame record or the default value if the field is not present in the GelFrame record.

fillFocusOpid (4 bytes): An unsigned integer that specifies the identifier of the fillFocus property. MUST be 0x018C, which is the same value as the **opid.opid** field of the fillFocus property as specified in [MS-ODRAW] section 2.3.7.15.

fillFocus (4 bytes): An unsigned integer that specifies the fillFocus property. MUST equal the value specified by the **fillFocus** field of the related GelFrame record or the default value if the field is not present in the GelFrame record.

fillToLeftOpid (4 bytes): An unsigned integer that specifies the identifier of the fillToLeft property. MUST be 0x018D, which is the same value as the **opid.opid** field of the fillToLeft property as specified in [MS-ODRAW] section 2.3.7.16.

fillToLeft (4 bytes): An unsigned integer that specifies the fillToLeft property. MUST equal the value specified by the **fillToLeft** field of the related GelFrame record or the default value if the field is not present in the GelFrame record.

fillToTopOpid (4 bytes): An unsigned integer that specifies the identifier of the fillToTop property. MUST be 0x018E, which is the same value as the **opid.opid** field of the fillToTop property as specified in [MS-ODRAW] section 2.3.7.17.

fillToTop (4 bytes): An unsigned integer that specifies the fillToTop property. MUST equal the value specified by the **fillToTop** field of the related GelFrame record or the default value if the field is not present in the GelFrame record.

fillToRightOpid (4 bytes): An unsigned integer that specifies the identifier of the fillToRight property. MUST be 0x018F, which is the same value as the **opid.opid** field of the fillToRight property as specified in [MS-ODRAW] section 2.3.7.18.

fillToRight (4 bytes): An unsigned integer that specifies the fillToRight property. MUST equal the value specified by the **fillToRight** field of the related GelFrame record or the default value if the field is not present in the GelFrame record.

fillToBottomOpid (4 bytes): An unsigned integer that specifies the identifier of the fillToBottom property. MUST be 0x0190, which is the same value as the **opid.opid** field of the fillToBottom property as specified in [MS-ODRAW] section 2.3.7.19.

fillToBottom (4 bytes): An unsigned integer that specifies the fillToBottom property. MUST equal the value specified by the **fillToBottom** field of the related GelFrame record or the default value if the field is not present in the GelFrame record.

fillRectLeftOpid (4 bytes): An unsigned integer that specifies the identifier of the fillRectLeft property. MUST be 0x0191, which is the same value as the **opid.opid** field of the fillRectLeft property as specified in [MS-ODRAW] section 2.3.7.20.

fillRectLeft (4 bytes): An unsigned integer that specifies the fillRectLeft property. MUST equal the value specified by the **fillRectLeft** field of the related GelFrame record or the default value if the field is not present in the GelFrame record.

fillRectTopOpid (4 bytes): An unsigned integer that specifies the identifier of the fillRectTop property. MUST be 0x0192, which is the same value as the **opid.opid** field of the fillRectTop property as specified in [MS-ODRAW] section 2.3.7.21.

fillRectTop (4 bytes): An unsigned integer that specifies the fillRectTop property. MUST equal the value specified by the **fillRectTop** field of the related GelFrame record or the default value if the field is not present in the GelFrame record.

fillRectRightOpid (4 bytes): An unsigned integer that specifies the identifier of the fillRectRight property. MUST be 0x0193, which is the same value as the **opid.opid** field of the fillRectRight property as specified in [MS-ODRAW] section 2.3.7.22.

fillRectRight (4 bytes): An unsigned integer that specifies the fillRectRight property. MUST equal the value specified by the **fillRectRight** field of the related GelFrame record or the default value if the field is not present in the GelFrame record.

fillRectBottomOpid (4 bytes): An unsigned integer that specifies the identifier of the fillRectBottom property. MUST be 0x0194, which is the same value as the **opid.opid** field of the fillRectBottom property as specified in [MS-ODRAW] section 2.3.7.23.

fillRectBottom (4 bytes): An unsigned integer that specifies the fillRectBottom property. MUST equal the value specified by the **fillRectbottom** field of the related GelFrame record or the default value if the field is not present in the GelFrame record.

fillDztypeOpid (4 bytes): An unsigned integer that specifies the identifier of the fillDztype property. MUST be 0x0195, which is the same value as the **opid.opid** field of the fillDztype property as specified in [MS-ODRAW] section 2.3.7.24.

fillDztype (4 bytes): An unsigned integer that specifies the fillDztype property. MUST equal the value specified by the **fillDztype** field of the related GelFrame record or the default value if the field is not present in the GelFrame record.

fillShadePresetOpid (4 bytes): An unsigned integer that specifies the identifier of the fillShadePreset property. MUST be 0x0196, which is the same value as the **opid.opid** field of the fillShadePreset property as specified in [MS-ODRAW] section 2.3.7.25.

fillShadePreset (4 bytes): An unsigned integer that specifies the fillShadePreset property. MUST equal the value specified by the **fillShadePreset** field of the related GelFrame record or the default value if the field is not present in the GelFrame record.

fillShadeColorsOpid (4 bytes): An unsigned integer that specifies the identifier of the fillShadeColors property. MUST be 0x0197, which is the same value as the **opid.opid** field of the fillShadeColors property as specified in [MS-ODRAW] section 2.3.7.26.

fillShadeColors (4 bytes): An unsigned integer that specifies the number of bytes of data in the following **fillShadeColors_complex** field.

fillShadeColors_complex (variable): An IMsoArray as specified in [MS-ODRAW] section 2.2.51 that specifies the fillShadeColors_complex property. This field MUST be present when **fillShadeColors** is greater than zero. MUST equal the value specified by the **fillShadeColors_complex** field of the related GelFrame record. MUST NOT be present when **fillShadeColors** is zero.

fillOriginXOpid (4 bytes): An unsigned integer that specifies the identifier of the fillOriginX property. MUST be 0x0198, which is the same value as the **opid.opid** field of the fillOriginX property as specified in [MS-ODRAW] section 2.3.7.28.

fillOriginX (4 bytes): An unsigned integer that specifies the fillOriginX property. MUST equal the value specified by the **fillOriginX** field of the related GelFrame record or the default value if the field is not present in the GelFrame record.

fillOriginYOpid (4 bytes): An unsigned integer that specifies the identifier of the fillOriginY property. MUST be 0x0199, which is the same value as the **opid.opid** field of the fillOriginY property as specified in [MS-ODRAW] section 2.3.7.29.

fillOriginY (4 bytes): An unsigned integer that specifies the fillOriginY property. MUST equal the value specified by the **fillOriginY** field of the related GelFrame record or the default value if the field is not present in the GelFrame record.

fillShapeOriginXOpid (4 bytes): An unsigned integer that specifies the identifier of the fillShapeOriginX property. MUST be 0x019A, which is the same value as the **opid.opid** field of the fillShapeOriginX property as specified in [MS-ODRAW] section 2.3.7.30.

fillShapeOriginX (4 bytes): An unsigned integer that specifies the fillShapeOriginX property. MUST equal the value specified by the **fillShapeOriginX** field of the related GelFrame record or the default value if the field is not present in the GelFrame record.

fillShapeOriginYOpid (4 bytes): An unsigned integer that specifies the identifier of the fillShapeOriginY property. MUST be 0x019B, which is the same value as the **opid.opid** field of the fillShapeOriginY property as specified in [MS-ODRAW] section 2.3.7.31.

fillShapeOriginY (4 bytes): An unsigned integer that specifies the fillShapeOriginY property. MUST equal the value specified by the **fillShapeOriginY** field of the related GelFrame record or the default value if the field is not present in the GelFrame record.

fillShadeTypeOpid (4 bytes): An unsigned integer that specifies the identifier of the fillShadeType property. MUST be 0x019C, which is the same value as the **opid.opid** field of the fillShadeType property as specified in [MS-ODRAW] section 2.3.7.32.

fillShadeType (4 bytes): An unsigned integer that specifies the fillShadeType property. MUST equal the value specified by the **fillShadeType** field of the related GelFrame record or the default value if the field is not present in the GelFrame record.

fillColorExtOpid (4 bytes): An unsigned integer that specifies the identifier of the fillColorExt property. MUST be 0x019E, which is the same value as the **opid.opid** field of the fillColorExt property as specified in [MS-ODRAW] section 2.3.7.33.

fillColorExt (4 bytes): An unsigned integer that specifies the fillColorExt property. MUST equal the value specified by the **fillColorExt** field of the related GelFrame record or the default value if the field is not present in the GelFrame record.

reserved415Opid (4 bytes): An unsigned integer that specifies the identifier of the reserved415 property. MUST be 0x019F, which is the same value as the **opid.opid** field of the reserved415 property as specified in [MS-ODRAW] section 2.3.7.34.

reserved1 (4 bytes): MUST be 0xFFFFFFFF.

fillColorExtModOpid (4 bytes): An unsigned integer that specifies the identifier of fillColorExtMod property. MUST be 0x01A0, which is the same value as the **opid.opid** field of the fillColorExtMod property as specified in [MS-ODRAW] section 2.3.7.35.

fillColorExtMod (4 bytes): An unsigned integer that specifies the fillColorExtMod property. MUST equal the value specified by the **fillColorExtMod** field of the related GelFrame record or the default value if the field is not present in the GelFrame record.

reserved417Opid (4 bytes): An unsigned integer that specifies the identifier of the reserved417 property. MUST be 0x01A1, which is the same value as the **opid.opid** field of the reserved417 property as specified in [MS-ODRAW] section 2.3.7.36.

reserved2 (4 bytes): MUST be 0x00000000.

fillBackColorExtOpid (4 bytes): An unsigned integer that specifies the identifier of fillBackColorExt property. MUST be 0x01A2, which is the same value as the **opid.opid** field of the fillBackColorExt property as specified in [MS-ODRAW] section 2.3.7.37.

fillBackColorExt (4 bytes): An unsigned integer that specifies the fillBackColorExt property. MUST equal the value specified by the **fillBackColorExt** field of the related GelFrame record or the default value if the field is not present in the GelFrame record.

reserved419Opid (4 bytes): An unsigned integer that specifies the identifier of the reserved419 property. MUST be 0x01A3, which is the same value as the **opid.opid** field of the reserved419 property as specified in [MS-ODRAW] section 2.3.7.38.

reserved3 (4 bytes): MUST be 0xFFFFFFFF.

fillBackColorExtModOpid (4 bytes): An unsigned integer that specifies the identifier of fillBackColorExtMod property. MUST be 0x01A4, which is the same value as the **opid.opid** field of the fillBackColorExtMod property as specified in [MS-ODRAW] section 2.3.7.39.

fillBackColorExtMod (4 bytes): An unsigned integer that specifies the fillBackColorExtMod property. MUST equal the value specified by the **fillBackColorExtMod** field of the related GelFrame record or the default value if the field is not present in the GelFrame record.

reserved421Opid (4 bytes): An unsigned integer that specifies the identifier of the reserved421 property. MUST be 0x01A5, which is the same value as the **opid.opid** field of the reserved421 property as specified in [MS-ODRAW] section 2.3.7.40.

reserved4 (4 bytes): MUST be 0x00000000.

reserved422Opid (4 bytes): An unsigned integer that specifies the identifier of the reserved422 property. MUST be 0x01A6, which is the same value as the **opid.opid** field of the reserved422 property as specified in [MS-ODRAW] section 2.3.7.41.

reserved5 (4 bytes): MUST be 0xFFFFFFFF.

reserved423Opid (4 bytes): An unsigned integer that specifies the identifier of the reserved423 property. MUST be 0x01A7, which is the same value as the **opid.opid** field of the reserved423 property as specified in [MS-ODRAW] section 2.3.7.42.

reserved6 (4 bytes): MUST be 0xFFFFFFFF.

fillstyle_fFilledOpid (4 bytes): An unsigned integer that specifies the identifier of the fFilled property. MUST be 0x01BB.

fillstyle_fFilled (4 bytes): An unsigned integer that specifies the fFilled property. MUST equal the value specified by the **fFilled** field of the related GelFrame record or the default value if the field is not present in the GelFrame record.

fillstyle_ffillShapeOpid (4 bytes): An unsigned integer that specifies the identifier of the ffillShape property. MUST be 0x01BD.

fillstyle_ffillShape (4 bytes): An unsigned integer that specifies the ffillShape property. MUST equal the value specified by the **ffillShape** field of the related GelFrame record or the default value if the field is not present in the GelFrame record.

fillstyle_ffillUseRectOpid (4 bytes): An unsigned integer that specifies the identifier of the ffillUseRect property. MUST be 0x01BE.

fillstyle_ffillUseRect (4 bytes): An unsigned integer that specifies the ffillUseRect property. MUST equal the value specified by the **ffillUseRect** field of the related GelFrame record or the default value if the field is not present in the GelFrame record.

2.5.129 FontIndex

The **FontIndex** structure specifies a [Font](#) record in the file.

0	1	2	3	4	5	6	7	8	9	10	1	2	3	4	5	6	7	8	9	20	1	2	3	4	5	6	7	8	9	30	1
ifnt																															

ifnt (2 bytes): An unsigned integer. If this value is less than 4, then it specifies a zero-based index of a Font record in the collection of Font records in the [Globals Substream](#). If this value is greater than 4, then it specifies a one-based index of a Font record in the collection of Font records in the Globals Substream. MUST NOT equal 4, and MUST be less than or equal to 1022. SHOULD [<168>](#) be less than or equal to 510.

The Font records in the Globals Substream are organized into two sections. The first section contains four Font records which MUST be present and MUST be ordered as follows [<169>](#):

Ifnt value	Meaning
0	Default font
1	Default font, bold
2	Default font, italic
3	Default font, bold and italic

The second section, which is optional, contains Font records for any additional font formatting properties present in the file. For example, the 5th Font record in the file is referred to by **ifnt** value 5.

2.5.130 FontInfo

The **FontInfo** structure specifies a **font** entry used by the [FrtFontList](#) record.

0	1	2	3	4	5	6	7	8	9	10	1	2	3	4	5	6	7	8	9	20	1	2	3	4	5	6	7	8	9	30	1
A	reserved																	ifnt													

A - fScaled (1 bit): A bit that specifies whether the fonts are scaled. MUST be a value from the following table [<170>](#):

Value	Meaning
0x0	Font has fixed size
0x1	Font scales with chart area (section 2.2.3.17) in a chart , or plot area

reserved (15 bits): MUST be zero, and MUST be ignored.

ifnt (2 bytes): A [FontIndex](#) that specifies the font used by the FrtFontList record.

2.5.131 FontScheme

The **FontScheme** enumeration specifies the **font scheme** to which this **font** belongs. When a font is part of a theme as specified in [ECMA-376](#) part 1, section 14.2.7, the font is categorized as a **major scheme** or a **minor scheme**.

Name	Value	Meaning
XFSNONE	0x00	No font scheme
XFSMAJOR	0x01	Major scheme
XFSMINOR	0x02	Minor scheme
XFSNIL	0xFF	Ninched state

2.5.132 FormatRun

The **FormatRun** structure specifies formatting information for a **text run**.

0	1	2	3	4	5	6	7	8	9	10	1	2	3	4	5	6	7	8	9	20	1	2	3	4	5	6	7	8	9	30	1
ich																ifnt															

ich (2 bytes): An unsigned integer that specifies the zero-based index of the first character of the text that contains the text run. When this record is used in an array, this value MUST be in strictly increasing order.

ifnt (2 bytes): A [FontIndex](#) structure that specifies the **font**. If **ich** is equal to the length of the text, this record is undefined and MUST be ignored.

2.5.133 FormulaValue

The **FormulaValue** structure specifies the current value of a formula. It can be a numeric value, a Boolean value, an error value, a string value, or a blank string value. If **fExprO** is not 0xFFFF, the 8 bytes of this structure specify an Xnum (section [2.5.342](#)). If **fExprO** is 0xFFFF, this structure specifies a Boolean value, an error value, a string value, or a blank string value.

0	1	2	3	4	5	6	7	8	9	10	1	2	3	4	5	6	7	8	9	20	1	2	3	4	5	6	7	8	9	30	1
byte1								byte2								byte3								byte4							
byte5								byte6								fExprO															

byte1 (1 byte): If **fExprO** is 0xFFFF, **byte1** is an unsigned integer that specifies the formula value type and MUST be a value from the following table:

Value	Meaning
0x00	String value. The string value is stored in a String record that immediately follows this record.
0x01	Boolean value.
0x02	Error value.
0x03	Blank string value.

If **fExprO** is not 0xFFFF, **byte1** specifies the first byte of the Xnum.

byte2 (1 byte): If **fExprO** is 0xFFFF, **byte2** is undefined and MUST be ignored. If **fExprO** is not 0xFFFF, **byte2** specifies the second byte of the Xnum (section 2.5.342).

byte3 (1 byte): The meaning of byte3 is specified in the following table:

Value	Meaning
fExprO is 0xFFFF and byte1 is 0x00	byte3 is undefined and MUST be ignored.
fExprO is 0xFFFF and byte1 is 0x01	byte3 specifies a Boolean value.
fExprO is 0xFFFF and byte1 is 0x02	byte3 specifies a BErr .
fExprO is 0xFFFF and byte1 is 0x03	byte3 is undefined and MUST be ignored.
fExprO is not 0xFFFF	byte3 specifies the third byte of the Xnum.

byte4 (1 byte): If **fExprO** is 0xFFFF, **byte4** is undefined and MUST be ignored. If **fExprO** is not 0xFFFF, **byte4** specifies the fourth byte of the Xnum.

byte5 (1 byte): If **fExprO** is 0xFFFF, **byte5** is undefined and MUST be ignored. If **fExprO** is not 0xFFFF, **byte5** specifies the fifth byte of the Xnum.

byte6 (1 byte): If **fExprO** is 0xFFFF, **byte6** is undefined and MUST be ignored. If **fExprO** is not 0xFFFF, **byte6** specifies the sixth byte of the Xnum.

fExprO (2 bytes): If **fExprO** is 0xFFFF, this structure specifies a Boolean value, an error value, a string value, or a blank string value. If **fExprO** is not 0xFFFF, **fExprO** specifies the last two bytes of the Xnum.

2.5.134 FrtFlags

The **FrtFlags** structure specifies flags used in [future record](#) headers.

0	1	2	3	4	5	6	7	8	9	10	11	12	13	14	15	16	17	18	19	20	21	22	23	24	25	26	27	28	29	30	31
A	B	reserved																													

A - fFrtRef (1 bit): A bit that specifies whether the containing record specifies a **range of cells**. MUST be a value from the following table:

Value	Meaning
0	The containing record does not specify a range of cells. The containing record's ref8.rwFirst, ref8.rwLast, ref8.colFirst, and ref8.colLast fields SHOULD <171> all be zero.
1	The containing record specifies a range of cells.

B - fFrtAlert (1 bit): A bit that specifies whether to alert the user of possible problems when saving the file without having recognized this record.

reserved (14 bits): MUST be zero, and MUST be ignored.

2.5.135 FrtHeader

The **FrtHeader** structure specifies a [future record](#) type header.

0	1	2	3	4	5	6	7	8	9	10	11	12	13	14	15	16	17	18	19	20	21	22	23	24	25	26	27	28	29	30	31
rt																grbitFrt															
reserved																															
...																															

rt (2 bytes): An unsigned integer that specifies the record type identifier. MUST be identical to the record type identifier of the containing record.

grbitFrt (2 bytes): An [FrtFlags](#) that specifies attributes for this record. The value of **grbitFrt.fFrtRef** MUST be zero. The value of **grbitFrt.fFrtAlert** MUST be zero.

reserved (8 bytes): MUST be zero, and MUST be ignored.

2.5.136 FrtHeaderOld

The **FrtHeaderOld** structure specifies a [future record](#) type header.

0	1	2	3	4	5	6	7	8	9	10	11	12	13	14	15	16	17	18	19	20	21	22	23	24	25	26	27	28	29	30	31
rt																grbitFrt															

rt (2 bytes): An unsigned integer that specifies the record type identifier. MUST be identical to the record type identifier of the containing record.

grbitFrt (2 bytes): An [FrtFlags](#) that specifies attributes for this record. The value of **grbitFrt.fFrtRef** MUST be zero. The value of **grbitFrt.fFrtAlert** MUST be zero.

2.5.137 FrtRefHeader

The **FrtRefHeader** structure specifies a [future record](#) type header.

0	1	2	3	4	5	6	7	8	9	10	11	12	13	14	15	16	17	18	19	20	21	22	23	24	25	26	27	28	29	30	31
rt																grbitFrt															
ref8																															

...

rt (2 bytes): An unsigned integer that specifies the record type identifier. MUST be identical to the record type identifier of the containing record.

grbitFrt (2 bytes): A [FrtFlags](#) that specifies attributes for this record. The value of **grbitFrt.fFrtAlert** MUST be zero.

ref8 (8 bytes): A [Ref8](#) that references the **range** of **cells** associated with the containing record. If **grbitFrt.fFrtRef** is zero then **ref8.rwFirst** MUST be zero, **ref8.rwLast** MUST be zero, **ref8.colFirst** MUST be zero, and **ref8.colLast** MUST be zero.

2.5.138 FrtRefHeaderNoGrbit

The **FrtRefHeaderNoGrbit** structure specifies a [future record](#) type header.

0	1	2	3	4	5	6	7	8	9	10	11	12	13	14	15	16	17	18	19	20	21	22	23	24	25	26	27	28	29	30	31
rt																ref8															
...																															
...																															

rt (2 bytes): An unsigned integer that specifies the record type identifier. MUST be identical to the record type identifier of the containing record.

ref8 (8 bytes): A [Ref8U](#) that references the **range** of **cells** associated with the containing record.

2.5.139 FrtRefHeaderU

The **FrtRefHeaderU** structure specifies a [future record](#) type header.

0	1	2	3	4	5	6	7	8	9	10	11	12	13	14	15	16	17	18	19	20	21	22	23	24	25	26	27	28	29	30	31
rt																grbitFrt															
ref8																															
...																															

rt (2 bytes): An unsigned integer that specifies the record type identifier. MUST be identical to the record type identifier of the containing record.

grbitFrt (2 bytes): A [FrtFlags](#) that specifies attributes for this record. The value of **grbitFrt.fFrtAlert** MUST be zero.

ref8 (8 bytes): A [Ref8U](#) that references the **range** of **cells** associated with the containing record. If **rt** is [Feature11](#) (0x0872) or [Feature12](#) (0x0878), this field MUST be ignored.

2.5.140 FtCbIs

The **FtCbIs** structure appears as part of an [Obj](#) record that represents a checkbox or radio button.

0	1	2	3	4	5	6	7	8	9	10	11	12	13	14	15	16	17	18	19	20	21	22	23	24	25	26	27	28	29	30	31
ft																cb															
unused1																															
unused2																															
unused3																															

ft (2 bytes): Reserved. MUST be 0x000A.

cb (2 bytes): Reserved. MUST be 0x000C.

unused1 (4 bytes): Undefined and MUST be ignored.

unused2 (4 bytes): Undefined and MUST be ignored.

unused3 (4 bytes): Undefined and MUST be ignored.

2.5.141 FtCbIsData

The **FtCbIsData** structure specifies the properties of the checkbox or radio button [Obj](#) that contains this FtCbIsData.

0	1	2	3	4	5	6	7	8	9	10	11	12	13	14	15	16	17	18	19	20	21	22	23	24	25	26	27	28	29	30	31
ft																cb															
fChecked																accel															
reserved																A	unused														

ft (2 bytes): Reserved. MUST be 0x0012.

cb (2 bytes): Reserved. MUST be 0x0008.

fChecked (2 bytes): An unsigned integer that specifies the state of the checkbox or radio button control. MUST be a value from the following table:

Value	Meaning
0x0000	The control is in an unchecked state.
0x0001	The control is in a checked state.

Value	Meaning
0x0002	The control is in a mixed state. The fChecked field MUST NOT have this value if the cmo.ot field of the Obj record that contains this FtPioGrbit is not equal to 0x0B.

accel (2 bytes): An unsigned integer that specifies the **Unicode** character of the control's **accelerator key**. A value of 0x0000 specifies there is no accelerator associated with this control. This field MUST be ignored unless this structure is used in the [Dialog Sheet Substream](#).

reserved (2 bytes): Reserved. MUST be 0x0000.

A - fNo3d (1 bit): A bit that specifies whether the control is expected to be displayed without three-dimensional effects.

unused (15 bits): Undefined and MUST be ignored.

2.5.142 FtCf

The **FtCf** structure specifies the clipboard format of the picture-type [Obj](#) record containing this FtCf.

0	1	2	3	4	5	6	7	8	9	10	11	12	13	14	15	16	17	18	19	20	21	22	23	24	25	26	27	28	29	30	31
ft																cb															
cf																															

ft (2 bytes): Reserved. MUST be 0x0007.

cb (2 bytes): Reserved. MUST be 0x0002.

cf (2 bytes): An unsigned integer that specifies the Windows clipboard format of the data associated with the picture. This field's value MUST be in the following table:

Value	Format
0x0002	Specifies the format of the picture is an enhanced metafile .
0x0009	Specifies the format of the picture is a bitmap.
0xFFFF	Specifies the picture is in an unspecified format that is neither an enhanced metafile nor a bitmap.

2.5.143 FtCmo

The **FtCmo** structure specifies the common properties of the [Obj](#) record that contains this FtCmo.

0	1	2	3	4	5	6	7	8	9	10	11	12	13	14	15	16	17	18	19	20	21	22	23	24	25	26	27	28	29	30	31
ft																cb															
ot																id															
A	B	C	D	E	F	G	H	I	J	K	L	M	N	O	P	unused8															
...																unused9															
...																unused10															
...																															

ft (2 bytes): Reserved. MUST be 0x15.

cb (2 bytes): Reserved. MUST be 0x12.

ot (2 bytes): An unsigned integer that specifies the type of object represented by the Obj record that contains this FtCmo. MUST be a value from the following table:

Value	Type of Object
0x0000	Group
0x0001	Line
0x0002	Rectangle
0x0003	Oval
0x0004	Arc
0x0005	Chart
0x0006	Text
0x0007	Button
0x0008	Picture
0x0009	Polygon
0x000B	Checkbox
0x000C	Radio button
0x000D	Edit box
0x000E	Label
0x000F	Dialog box
0x0010	Spin control
0x0011	Scrollbar
0x0012	List

Value	Type of Object
0x0013	Group box
0x0014	Dropdown list
0x0019	Note
0x001E	OfficeArt object

id (2 bytes): An unsigned integer that specifies the identifier of this object. This object identifier is used by other types to refer to this object. The value of **id** MUST be unique among all Obj records within the [Chart Sheet Substream ABNF](#), [Macro Sheet Substream ABNF](#) and [Worksheet Substream ABNF](#).

A - fLocked (1 bit): A bit that specifies whether this object is **locked**.

B - reserved (1 bit): Reserved. MUST be 0.

C - fDefaultSize (1 bit): A bit that specifies whether the application is expected to choose the object's size.

D - fPublished (1 bit): A bit that specifies whether this is a [chart](#) object that is expected to be **published** the next time the **sheet** containing it is published [<172>](#). This bit is ignored if the **fPublishedBookItems** field of the [BookExt_Conditional12](#) structure is zero.

E - fPrint (1 bit): A bit that specifies whether the image of this object is intended to be included when printed.

F - unused1 (1 bit): Undefined and MUST be ignored.

G - unused2 (1 bit): Undefined and MUST be ignored

H - fDisabled (1 bit): A bit that specifies whether this object has been disabled.

I - fUIObj (1 bit): A bit that specifies whether this is an auxiliary object that can only be automatically inserted by the application (as opposed to an object that can be inserted by a user).

J - fRecalcObj (1 bit): A bit that specifies whether this object is expected to be updated on load to reflect the values in the **range** associated with the object. This field MUST be ignored unless the **pictFmla.key** field of the containing Obj exists and **pictFmla.key.fmlaListFillRange.cbFmla** of the containing Obj is not equal to 0.

K - unused3 (1 bit): Undefined and MUST be ignored.

L - unused4 (1 bit): Undefined and MUST be ignored.

M - fRecalcObjAlways (1 bit): A bit that specifies whether this object is expected to be updated whenever the value of a **cell** in the range associated with the object changes. This field MUST be ignored unless the **pictFmla.key** field of the containing Obj exists and **pictFmla.key.fmlaListFillRange.cbFmla** of the containing Obj is not equal to 0.

N - unused5 (1 bit): Undefined and MUST be ignored.

O - unused6 (1 bit): Undefined and MUST be ignored.

P - unused7 (1 bit): Undefined and MUST be ignored.

unused8 (4 bytes): Undefined and MUST be ignored.

unused9 (4 bytes): Undefined and MUST be ignored.

unused10 (4 bytes): Undefined and MUST be ignored.

2.5.144 FtEdoData

This structure specifies the properties of the edit box [Obj](#) record that contains this FtEdoData.

0	1	2	3	4	5	6	7	8	9	10	11	12	13	14	15	16	17	18	19	20	21	22	23	24	25	26	27	28	29	30	31
ft																cb															
ivtEdit																fMultiLine															
fvScroll																id															

ft (2 bytes): Reserved. MUST be 0x0010.

cb (2 bytes): Reserved. MUST be 0x0008.

ivtEdit (2 bytes): An unsigned integer that specifies what input **data validation** is expected to be performed by this edit box. MUST be a value from the following table:

Value	Strings accepted by validation
0x0000	Any string; no validation is expected.
0x0001	An integer.
0x0002	A number.
0x0003	A range reference.
0x0004	A formula (section 2.2.2).

fMultiLine (2 bytes): A Boolean (section [2.5.14](#)) that specifies whether this edit box supports multiple lines of text. MUST be a value from the following table:

Value	Meaning
0x0000	Only one line is supported.
0x0001	Multiple lines are supported.

fvScroll (2 bytes): A Boolean that specifies whether this edit box contains a vertical scrollbar. MUST be a value from the following table:

Value	Meaning
0x0000	Scrollbar is expected not to be displayed.

Value	Meaning
0x0001	Scrollbar is expected to be displayed.

id (2 bytes): An [ObjId](#) that specifies the associated list control. The associated list control is the control specified by the Obj record whose **cmo.id** field is equal to **id.id**. A value of **id.id** equal to 0 specifies that there is no list control associated with this edit box.

2.5.145 FtGboData

The **FtGboData** structure specifies the properties of the group box [Obj](#) record that contains this FtGboData.

0	1	2	3	4	5	6	7	8	9	10	11	12	13	14	15	16	17	18	19	20	21	22	23	24	25	26	27	28	29	30	31
ft																cb															
accel																reserved															
A	unused2																														

ft (2 bytes): Reserved. MUST be 0x000F.

cb (2 bytes): Reserved. MUST be 0x0006.

accel (2 bytes): An unsigned integer that specifies the **Unicode** character of the object's **accelerator key**. A value of 0x0000 specifies there is no accelerator key associated with this object. This field MUST be ignored unless this object is in a **dialog sheet**.

reserved (2 bytes): Reserved. MUST be 0x0000.

A - fNo3d (1 bit): A bit that specifies whether this control is expected to be displayed without three-dimensional effects.

unused2 (15 bits): Undefined and MUST be ignored.

2.5.146 FtGmo

The **FtGmo** structure appears in a group-type [Obj](#) record.

0	1	2	3	4	5	6	7	8	9	10	11	12	13	14	15	16	17	18	19	20	21	22	23	24	25	26	27	28	29	30	31
ft																cb															
unused																															

ft (2 bytes): Reserved. MUST be 0x0006.

cb (2 bytes): Reserved. MUST be 0x0002

unused (2 bytes): Undefined and MUST be ignored.

2.5.147 FtLbsData

The **FtLbsData** structure specifies the properties of a list or drop-down list **embedded object** in a **sheet**.

0	1	2	3	4	5	6	7	8	9	10	11	12	13	14	15	16	17	18	19	20	21	22	23	24	25	26	27	28	29	30	31				
ft																cbFContinued																			
fmla (variable)																																			
...																																			
cLines																iSel																			
A	B	C	D	E	F	G	lct														idEdit														
dropData (variable)																																			
...																																			
rgLines (variable)																																			
...																																			
bsels (variable)																																			
...																																			

ft (2 bytes): Reserved. MUST be 0x0013.

cbFContinued (2 bytes): An unsigned integer that indirectly specifies whether some of the data in this structure appear in a subsequent [Continue](#) record. If **cbFContinued** is 0x0000, all of the fields in this structure except **ft** and **cbFContinued** MUST NOT exist. If this entire structure is contained within the same record, then **cbFContinued** MUST be greater than or equal to the size, in bytes, of this structure, not including the four bytes for the **ft** and **cbFContinued** fields. If part of this structure is in one or more subsequent Continue records, then the **cbFContinued** field MUST hold the value calculated according to the following formula:

$$\mathbf{cbFContinued} = \text{size of the fields of this structure in the current record} - 1.$$

fmla (variable): An [ObjFmla](#) that specifies the **range** of **cell** values that are the items in this list.

cLines (2 bytes): An unsigned integer that specifies the number of items in the list. MUST be less than or equal to 0x7FFF.

iSel (2 bytes): An unsigned integer that specifies the one-based index of the first selected item in this list. A value of 0x0000 specifies there is no currently **selected** item. MUST be less than or equal to **cLines**.

A - fUseCB (1 bit): A bit that specifies whether the **lct** field MUST be ignored. MUST be a value from the following table:

Value	Meaning
0	The lct field MUST be ignored.
1	The lct field MUST NOT be ignored.

B - fValidPlex (1 bit): A bit that specifies whether the **rgLines** field exists.

C - fValidIds (1 bit): A bit that specifies whether the **idEdit** field MUST be ignored. MUST be a value from the following table:

Value	Meaning
0	The idEdit field MUST be ignored.
1	The idEdit field MUST NOT be ignored.

D - fNo3d (1 bit): A bit that specifies whether this control is displayed without 3-dimensional effects. MUST be a value from the following table:

Value	Meaning
0	The control is displayed with 3-dimensional effects.
1	The control is not displayed with 3-dimensional effects.

E - wListSelType (2 bits): An unsigned integer that specifies the type of **selection** behavior this list control is expected to support. MUST be a value from the following table:

Value	Meaning
0	The list control is only allowed to have one selected item.
1	The list control is allowed to have multiple items selected by clicking on each item.
2	The list control is allowed to have multiple items selected by holding the CTRL key and clicking on each item.

F - unused (1 bit): Undefined and MUST be ignored.

G - reserved (1 bit): MUST be zero, and MUST be ignored.

lct (8 bits): An unsigned integer that specifies the behavior class of this list. MUST be ignored if the **fUseCB** field is 0. Otherwise, MUST be a value from the following table:

Value	Expected behavior of the control
0x00	Regular sheet dropdown control (like a list box object).

Value	Expected behavior of the control
0x01	PivotTable page field dropdown.
0x03	AutoFilter dropdown. The lct field MUST NOT have this value unless this object is in a worksheet or macro sheet .
0x05	AutoComplete dropdown.
0x06	Data validation list dropdown. The lct field MUST NOT have this value unless this object is in a worksheet or macro sheet.
0x07	PivotTable row or column field dropdown.
0x09	Dropdown for the Total Row of a table.

idEdit (2 bytes): An [ObjId](#) that specifies the edit box associated with this list. A value of **idEdit.id** equal to 0x0000 or a value of **fValidIds** equal to 0 specifies that there is no edit box associated with this list.

dropData (variable): An optional [LbsDropData](#) that specifies properties for this dropdown control. This field MUST exist if and only if the containing [Obj's cmo.ot](#) is equal to 0x0014.

rgLines (variable): An optional array of [XLUnicodeString](#). Each string in this array specifies an item in the list. This array MUST exist if and only if the **fValidPlex** field is equal to 1. The number of elements in this array, if it exists, MUST be **cLines**. The **cch** field of each string in this array MUST be less than or equal to 0x00FF. If this array does not fit in the owning Obj record, Continue records are used. Each string in this array MUST be entirely contained within the same record.

bsels (variable): An optional array of one-byte Booleans (section [2.5.14](#)) that specifies which items in the list are part of a multiple selection. This array MUST exist if and only if the **wListSelType** field is not equal to 0. The number of elements in this array, if it exists, MUST be **cLines**. The nth byte in this array specifies whether the nth list item is part of the multiple selection. The value of each element MUST be taken from the following table:

Value	Meaning
0x00	List item is not part of the multiple selection.
0x01	List item is part of the multiple selection.

If this array does not fit in the current record, or would come within eight bytes of the end of the maximum allowable size of that record, Continue records are used.

2.5.148 FtMacro

The **FtMacro** structure specifies an action associated with this control.

0	1	2	3	4	5	6	7	8	9	10	1	2	3	4	5	6	7	8	9	20	1	2	3	4	5	6	7	8	9	30	1		
ft																fmla (variable)																	
...																																	

ft (2 bytes): Reserved. MUST be 0x0004.

fmla (variable): An [ObjFmla](#) that specifies the name of a macro. The **fmla** field MUST refer to a name defined through an [Lbl](#) whose **fProc** field is 1.

2.5.149 FtNts

The **FtNts** structure specifies the properties of the note-type [Obj](#) record containing this FtNts.

0	1	2	3	4	5	6	7	8	9	10	11	12	13	14	15	16	17	18	19	20	21	22	23	24	25	26	27	28	29	30	31
ft																cb															
guid (16 bytes)																															
...																															
...																															
fSharedNote																unused															
...																															

ft (2 bytes): Reserved. MUST be 0x000D.

cb (2 bytes): Reserved. MUST be 0x0016.

guid (16 bytes): A GUID as specified by [\[MS-DTYP\]](#) that specifies the Globally Unique identifier of this **comment**.

fSharedNote (2 bytes): A Boolean (section [2.5.14](#)) that specifies whether the comment is shared. MUST be a value from the following table:

Value of fSharedNote	Meaning
0x0000	Not shared
0x0001	Shared

unused (4 bytes): Undefined and MUST be ignored.

2.5.150 FtPictFmla

The **FtPictFmla** structure specifies the location of the data associated with the picture [Obj](#) that contains this FtPictFmla.

0	1	2	3	4	5	6	7	8	9	10	11	12	13	14	15	16	17	18	19	20	21	22	23	24	25	26	27	28	29	30	31
ft																cb															

fmla (variable)
...
IPosInCtlStm (optional)
cbBufInCtlStm (optional)
key (variable)
...

ft (2 bytes): Reserved. MUST be 0x0009.

cb (2 bytes): An unsigned integer that specifies the length, in bytes of this FtPictFmla, not including **ft** and **cb** fields.

fmla (variable): An [ObjFmla](#) that specifies the location of the data for the object associated with the Obj record that contains this FtPictFmla. If the **pictFlags.fDde** field of the Obj record that contains this FtPictFmla is 1, **fmla** MUST refer to a name which is defined in an [ExternName](#) record whose **fole** field is 1. If the **pictFlags.fCamera** field of the Obj record that contains this FtPictFmla is 1, **fmla** MUST refer to a **range**. Otherwise, the **fmla.cce** field of this **fmla** MUST be 0x5 and the **fmla.rgce** field of this **fmla** MUST contain a [PtgTbl](#) followed by four bytes that are undefined and MUST be ignored.

IPosInCtlStm (4 bytes): An optional unsigned integer whose meaning depends on the value of the **cmo.fPrstm** field of the Obj record that contains this FtPictFmla. This field MUST exist if and only if this structure's **fmla.fmla.rgce** field starts with a [PtgTbl](#). The following table explains the two possible meanings of **IPosInCtlStm**:

Value of cmo.fPrstm	Meaning of IPosInCtlStm
0	The object's data MUST reside in an embedding storage whose name is the concatenation of "MBD" and the eight byte hexadecimal representation of IPosInCtlStm's value.
1	IPosInCtlStm specifies the zero-based offset of this object's data within the control stream (Ctls) .

cbBufInCtlStm (4 bytes): An optional unsigned integer that specifies the size of this object's data within the control stream. This field MUST exist if and only if the **pictFlags.fPrstm** field of the Obj record that contains this FtPictFmla equals 1.

key (variable): An optional [PictFmlaKey](#). MUST exist if and only if the **pictFlags.fCtl** field of the Obj record that contains this FtPictFmla equals 1.

2.5.151 FtPioGrbit

The **FtPioGrbit** structure specifies Boolean properties of the picture [Obj](#) containing this FtPioGrbit.

0	1	2	3	4	5	6	7	8	9	10	11	12	13	14	15	16	17	18	19	20	21	22	23	24	25	26	27	28	29	30	31
ft															cb																
A	B	C	D	E	F	G	H	I	J	unused2																					

ft (2 bytes): Reserved. MUST be 0x0008.

cb (2 bytes): Reserved. MUST be 0x0002.

A - fAutoPict (1 bit): A bit that specifies whether the picture's aspect ratio is preserved when rendered in different views (**Normal view**, **Page Break Preview view**, **Page Layout view** and printing).

B - fDde (1 bit): A bit that specifies whether the **pictFmla** field of the Obj record that contains this FtPioGrbit specifies a **DDE** reference.

C - fPrintCalc (1 bit): A bit that specifies whether this object is expected to be updated on print to reflect the values in the **cell** associated with the object.

D - fIcon (1 bit): A bit that specifies whether the picture is displayed as an icon.

E - fCtl (1 bit): A bit that specifies whether this object is an **ActiveX control**. It MUST NOT be the case that both **fCtl** and **fDde** are equal to 1.

F - fPrstm (1 bit): A bit that specifies whether the object data are stored in an [embedding storage](#) or in the [controls stream \(ctls\)](#). See [FtPictFmla](#)'s **IPosInCtlStm** and **cbBufInCtlStm** fields for more detail.

Value of fPrstm	Location of object data
0	An embedding storage.
1	The controls stream (ctls).

G - unused1 (1 bit): Undefined and MUST be ignored.

H - fCamera (1 bit): A bit that specifies whether this is a **camera picture**.

I - fDefaultSize (1 bit): A bit that specifies whether this picture's size has been explicitly set. The value of **fDefaultSize** MUST be taken from the following table:

Value	Meaning
0	This picture's size has been explicitly set.
1	This picture's size has not been explicitly set.

J - fAutoLoad (1 bit): A bit that specifies whether the **OLE server** for the object is called to load the object's data automatically when the parent **workbook** is opened.

unused2 (6 bits): Undefined and MUST be ignored.

2.5.152 FtRbo

The **FtRbo** structure appears as part of an [Obj](#) record that represents a radio button.

0	1	2	3	4	5	6	7	8	9	10	11	12	13	14	15	16	17	18	19	20	21	22	23	24	25	26	27	28	29	30	31
ft																cb															
unused1																															
unused2																															

ft (2 bytes): Reserved. MUST be 0x000B.

cb (2 bytes): Reserved. MUST be 0x0006.

unused1 (4 bytes): Undefined and MUST be ignored.

unused2 (2 bytes): Undefined and MUST be ignored.

2.5.153 FtRboData

The **FtRboData** structure specifies the properties of the radio button [Obj](#) containing this FtRboData.

0	1	2	3	4	5	6	7	8	9	10	11	12	13	14	15	16	17	18	19	20	21	22	23	24	25	26	27	28	29	30	31
ft																cb															
idRadNext																fFirstBtn															

ft (2 bytes): Reserved. MUST be 0x0011.

cb (2 bytes): Reserved. MUST be 0x0004.

idRadNext (2 bytes): An [ObjId](#) that specifies the next radio button in a group of radio buttons. A value of **idRadNext.id** equal to 0 or equal to the containing Obj's **cmo.id** specifies there is no next radio button.

fFirstBtn (2 bytes): A Boolean (section [2.5.14](#)) that specifies whether this is the first radio button in its group. MUST be a value from the following table:

Value	Meaning
0x0000	This is not the first radio button.
0x0001	This is the first radio button in the group.

2.5.154 FtSbs

The **FtSbs** structure specifies the properties of the scrollable control represented by the [Obj](#) record that contains this FtSbs.

0	1	2	3	4	5	6	7	8	9	10	11	12	13	14	15	16	17	18	19	20	21	22	23	24	25	26	27	28	29	30	31					
ft																cb																				
unused1																																				
iVal																iMin																				
iMax																dInc																				
dPage																fHoriz																				
dxScroll																A	B	C	D	unused2																

ft (2 bytes): Reserved. MUST be 0x000C.

cb (2 bytes): Reserved. MUST be 0x0014.

unused1 (4 bytes): Undefined and MUST be ignored.

iVal (2 bytes): A signed integer that specifies the current value of the control. This value MUST be greater than or equal to **iMin**. This value MUST be less than or equal to **iMax**.

iMin (2 bytes): A signed integer that specifies the minimum allowable value of the control.

iMax (2 bytes): A signed integer that specifies the maximum allowable value of the control. This value MUST be greater than or equal to **iMin**.

dInc (2 bytes): A signed integer that specifies the amount by which the control's value is changed when the user clicks on one of the control's minor increment regions. MUST be greater than or equal to 0x0000.

dPage (2 bytes): A signed integer that specifies the amount by which the control's value is changed when the user clicks on the scrollbar's page up or page down region. MUST be greater than or equal to 0x0000.

fHoriz (2 bytes): A Boolean (section [2.5.14](#)) that specifies whether this control scrolls horizontally or vertically. MUST be a value from the following table:

0x0000	Vertical scrolling
0x0001	Horizontal scrolling

dxScroll (2 bytes): A signed integer that specifies the width in pixels of the scrollbar. MUST be greater than or equal to 0x0000.

A - fDraw (1 bit): A bit that specifies whether this control is expected to be displayed.

B - fDrawSliderOnly (1 bit): A bit that specifies whether only the slider portion of this control is expected to be displayed.

C - fTrackElevator (1 bit): A bit that specifies whether the control is expected to interactively track a mouse drag of the control's scroll thumb (aka elevator).

D - fNo3d (1 bit): A bit that specifies whether the control is expected to be displayed without three-dimensional effects.

unused2 (12 bits): Undefined and MUST be ignored.

2.5.155 FullColorExt

The **FullColorExt** structure specifies a color.

0	1	2	3	4	5	6	7	8	9	10	11	12	13	14	15	16	17	18	19	20	21	22	23	24	25	26	27	28	29	30	31
xclrType																nTintShade															
xclrValue																															
unused																															
...																															

xclrType (2 bytes): An [XColorType](#) that specifies how the color information is stored.

nTintShade (2 bytes): A signed integer that specifies the tint of the color. Positive values lighten the color, and negative values darken the color.

xclrValue (4 bytes): An unsigned integer that specifies the color data. If **xclrType** equals 0x00 or 0x04, this value MUST be 0. If **xclrType** equals 0x01, this field contains an [IcvXF](#) that specifies a color in the color table. If **xclrType** equals 0x02, this field contains a [LongRGBA](#) that specifies an **red-green-blue-alpha (RGBA)** value. If **xclrType** equals 0x03, this field contains a [ColorTheme](#) that specifies a theme color.

unused (8 bytes): Undefined and MUST be ignored.

2.5.156 GradStop

The **GradStop** structure specifies a **gradient stop** for a **gradient fill**.

0	1	2	3	4	5	6	7	8	9	10	11	12	13	14	15	16	17	18	19	20	21	22	23	24	25	26	27	28	29	30	31
xclrType																xclrValue															
...																numPosition															
...																															
...																numTint															

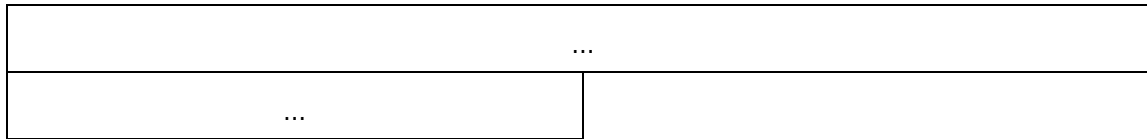

xclrType (2 bytes): An [XColorType](#) that specifies how the color information is stored.

xclrValue (4 bytes): An unsigned integer that specifies the color data. If **xclrType** equals 0x00 or 0x04, this value MUST be 0. If **xclrType** equals 0x01, this field contains an [IcvXF](#) that specifies color in the color table. If **xclrType** equals 0x02, this field contains a [LongRGBA](#) that specifies an **RGBA** value. If **xclrType** equals 0x03, this field contains a [ColorTheme](#) that specifies a theme color

numPosition (8 bytes): An Xnum (section [2.5.342](#)) that specifies the gradient stop position as the percentage of the gradient range. The gradient stop position is the position within the gradient range where this gradient stop's color begins. MUST be greater than or equal to 0.0 and less than or equal to 1.0.

numTint (8 bytes): An Xnum that specifies the tint of the color. MUST be greater than or equal to -1.0 and less than or equal to 1.0. Positive values lighten the color, and negative values darken the color.

2.5.157 HiddenMemberSet

The **HiddenMemberSet** structure specifies **OLAP members hidden** from a [PivotTable view](#) that are in the same level in an **OLAP hierarchy**.

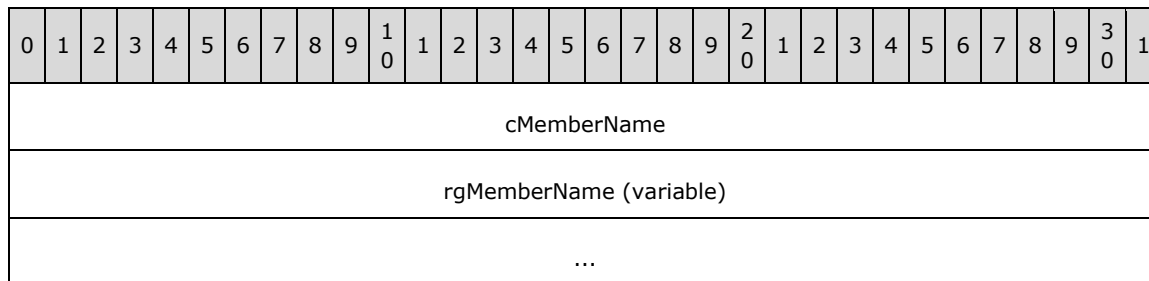

cMemberName (4 bytes): An unsigned integer that specifies the number of elements in **rgMemberName**.

rgMemberName (variable): An array of [XLUnicodeString](#) structures. Each element specifies the name of a hidden OLAP member. MUST exist if and only if the value of **cMemberName** is greater than 0.

2.5.158 HideObjEnum

The **HideObjEnum** enumeration specifies how **ActiveX objects**, **OLE objects**, and **drawing objects** appear in a window that contains the **workbook**.

Name	Value	Meaning
SHOWALL	0x0000	ActiveX objects, OLE objects, and drawing objects are displayed in the window that contains the workbook.
SHOWPLACEHOLDER	0x0001	Placeholders are displayed in place of ActiveX objects, OLE objects, and drawing objects in the window that contains the workbook.

Name	Value	Meaning
HIDEALL	0x0002	ActiveX objects, OLE objects, and drawing objects are not displayed in the window that contains the workbook.

2.5.159 HorizAlign

The **HorizAlign** enumeration specifies the horizontal alignment.

Name	Value	Meaning
ALCNIL	0xFF	Alignment not specified
ALCGEN	0x00	General alignment
ALCLEFT	0x01	Left alignment
ALCCTR	0x02	Centered alignment
ALCRIGHT	0x03	Right alignment
ALCFILL	0x04	Fill alignment
ALCJUST	0x05	Justify alignment
ALCCONTCTR	0x06	Center-across-selection alignment
ALCDIST	0x07	Distributed alignment

2.5.160 HorzBrk

The **HorzBrk** structure specifies one horizontal **page break**.

0	1	2	3	4	5	6	7	8	9	10	11	12	13	14	15	16	17	18	19	20	21	22	23	24	25	26	27	28	29	30	31
row																colStart															
colEnd																															

row (2 bytes): A [RwU](#) that specifies the zero-based index of the first row below the page break.

colStart (2 bytes): An unsigned integer that specifies the zero-based index of the first column on the page. MUST be less than or equal to 16383.

colEnd (2 bytes): An unsigned integer that specifies the zero-based index of the last column on the page. The value MUST be greater than **colStart** and less than or equal to 16383.

2.5.161 Icv

The **Icv** structure specifies a color in the color table.

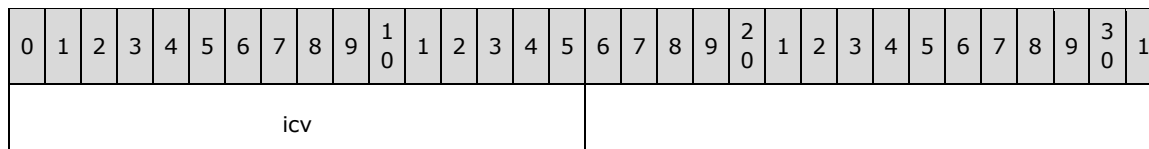

icv (2 bytes): An unsigned integer that specifies a color from the color table. The value MUST be one of the following values: a value greater than or equal to 0x0000 and less than or equal to 0x0041, a value greater than or equal to 0x004D and less than or equal to 0x004F, 0x0051, or 0x7FFF.

The values that are greater than or equal to 0x0000 and less than or equal to 0x0007 specify built-in color constants. This part of the color table is:

icv value	Color description	Red value	Green value	Blue value
0x0000	Black	0	0	0
0x0001	White	255	255	255
0x0002	Red	255	0	0
0x0003	Green	0	255	0
0x0004	Blue	0	0	255
0x0005	Yellow	255	255	0
0x0006	Magenta	255	0	255
0x0007	Cyan	0	255	255

The next 56 values in the table, the **icv** values greater than or equal to 0x0008 and less than or equal to 0x003F, specify the palette colors in the table. If a [Palette](#) record exists in this file, these **icv** values specify colors from the **rgColor** array in the Palette record. If no Palette record exists, these values specify colors in the default palette. The next 56 values in this part of the color table specify the following:

Value	If a palette record exists in this file:	Default red value (if no palette record in file)	Default green value (if no palette record in file)	Default blue value (if no palette record in file)
0x0008	Field rgColor [0] of Palette	0	0	0
0x0009	Field rgColor [1] of Palette	255	255	255
0x000A	Field rgColor [2] of Palette	255	0	0
0x000B	Field rgColor [3] of Palette	0	255	0
0x000C	Field rgColor [4] of Palette	0	0	255

Value	If a palette record exists in this file:	Default red value (if no palette record in file)	Default green value (if no palette record in file)	Default blue value (if no palette record in file)
0x000D	Field rgColor [5] of Palette	255	255	0
0x000E	Field rgColor [6] of Palette	255	0	255
0x000F	Field rgColor [7] of Palette	0	255	255
0x0010	Field rgColor [8] of Palette	128	0	0
0x0011	Field rgColor [9] of Palette	0	128	0
0x0012	Field rgColor [10] of Palette	0	0	128
0x0013	Field rgColor [11] of Palette	128	128	0
0x0014	Field rgColor [12] of Palette	128	0	128
0x0015	Field rgColor [13] of Palette	0	128	128
0x0016	Field rgColor [14] of Palette	192	192	192
0x0017	Field rgColor [15] of Palette	128	128	128
0x0018	Field rgColor [16] of Palette	153	153	255
0x0019	Field rgColor [17] of Palette	153	51	102
0x001A	Field rgColor [18] of Palette	255	255	204
0x001B	Field rgColor [19] of Palette	204	255	255
0x001C	Field rgColor [20] of Palette	102	0	102
0x001D	Field rgColor [21] of Palette	255	128	128
0x001E	Field rgColor [22] of Palette	0	102	204
0x001F	Field rgColor [23] of Palette	204	204	255
0x0020	Field rgColor [24] of Palette	0	0	128
0x0021	Field rgColor [25] of Palette	255	0	255
0x0022	Field rgColor [26] of Palette	255	255	0
0x0023	Field rgColor [27] of Palette	0	255	255
0x0024	Field rgColor [28] of Palette	128	0	128
0x0025	Field rgColor [29] of Palette	128	0	0
0x0026	Field rgColor [30] of Palette	0	128	128
0x0027	Field rgColor [31] of Palette	0	0	255
0x0028	Field rgColor [32] of Palette	0	204	255
0x0029	Field rgColor [33] of Palette	204	255	255
0x002A	Field rgColor [34] of Palette	204	255	204
0x002B	Field rgColor [35] of Palette	255	255	153

Value	If a palette record exists in this file:	Default red value (if no palette record in file)	Default green value (if no palette record in file)	Default blue value (if no palette record in file)
0x002C	Field rgColor [36] of Palette	153	204	255
0x002D	Field rgColor [37] of Palette	255	153	204
0x002E	Field rgColor [38] of Palette	204	153	255
0x002F	Field rgColor [39] of Palette	255	204	153
0x0030	Field rgColor [40] of Palette	51	102	255
0x0031	Field rgColor [41] of Palette	51	204	204
0x0032	Field rgColor [42] of Palette	153	204	0
0x0033	Field rgColor [43] of Palette	255	204	0
0x0034	Field rgColor [44] of Palette	255	153	0
0x0035	Field rgColor [45] of Palette	255	102	0
0x0036	Field rgColor [46] of Palette	102	102	153
0x0037	Field rgColor [47] of Palette	150	150	150
0x0038	Field rgColor [48] of Palette	0	51	102
0x0039	Field rgColor [49] of Palette	51	153	102
0x003A	Field rgColor [50] of Palette	0	51	0
0x003B	Field rgColor [51] of Palette	51	51	0
0x003C	Field rgColor [52] of Palette	153	51	0
0x003D	Field rgColor [53] of Palette	153	51	102
0x003E	Field rgColor [54] of Palette	51	51	153
0x003F	Field rgColor [55] of Palette	51	51	51

The remaining values in the color table specify colors associated with application display settings as follows:

Value	Meaning
0x0040	Default foreground color. This is the window text color in the sheet display.
0x0041	Default background color. This is the window background color in the sheet display and is the default background color for a cell .
0x004D	Default chart foreground color. This is the window text color in the chart display.
0x004E	Default chart background color. This is the window background color in the chart display.
0x004F	Chart neutral color which is black, an RGB value of (0,0,0).
0x0051	ToolTip text color. This is the automatic font color for

Value	Meaning
	comments.
0x7FFF	Font automatic color. This is the window text color.

2.5.162 IcvChart

The **IcvChart** structure specifies a color in the [Chart](#) color table. The Chart color table is a subset of the full color table. See [Icv](#) for more information about the colors in the Chart color table.

0	1	2	3	4	5	6	7	8	9	10	11	12	13	14	15	16	17	18	19	20	21	22	23	24	25	26	27	28	29	30	31
icv																															

icv (2 bytes): An [Icv](#) that specifies a color from the chart color table. This value MUST be greater than or equal to 0x0000 and less than or equal to 0x0041, or greater than or equal to 0x004D and less than or equal to 0x00004F. This value SHOULD NOT [<173>](#) be less than 0x0008.

2.5.163 IcvFont

The **IcvFont** structure specifies a color that is used by **fonts**. The font colors are a subset of the full color table.

0	1	2	3	4	5	6	7	8	9	10	11	12	13	14	15	16	17	18	19	20	21	22	23	24	25	26	27	28	29	30	31
icv																															

icv (2 bytes): An [Icv](#) that specifies a font color. MUST be greater than or equal to 0x0008 and less than or equal to 0x003F or 0x0051 or 0x7FFF.

2.5.164 IcvXF

The **IcvXF** structure specifies a color in the color table used by **cell** and **style** formatting properties.

0	1	2	3	4	5	6	7	8	9	10	11	12	13	14	15	16	17	18	19	20	21	22	23	24	25	26	27	28	29	30	31					
icv																																				

icv (7 bits): An unsigned integer that specifies a formatting property color. The value MUST be 0x48, or an [Icv](#) with a value greater than or equal to 0x01 and less than or equal to 0x3F, the default foreground color (0x40), or the default background color (0x41). This value SHOULD NOT [<174>](#) be 0x48, or less than or equal to 0x07.

2.5.165 IFmt

The **IFmt** structure specifies the identifier of a **number format**.

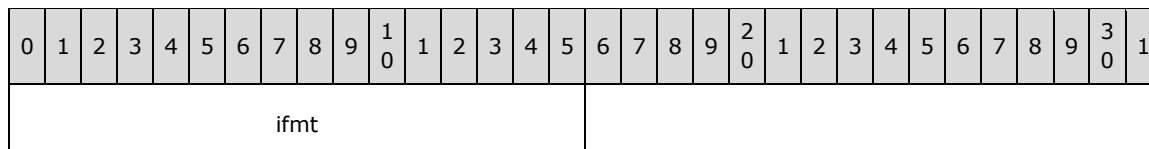

ifmt (2 bytes): An unsigned integer that specifies the identifier of a number format. The identifier specified by this field MUST be a valid built-in number format identifier or the identifier of a custom number format as specified using a [Format](#) record. Custom number format identifiers MUST be greater than or equal to 0x00A4 and less than or equal to 0x0188, and SHOULD <175> be less than or equal to 0x017E. The built-in number formats are listed in [\[ECMA-376\]](#) Part 4: Markup Language Reference, section 3.8.30.

2.5.166 InteriorColorPropertiesForShapePropsStreamChecksum

The **InteriorColorPropertiesForShapePropsStreamChecksum** structure specifies the interior color data used to compute the **checksum** of the [ShapePropsStream](#) record.

The related [AreaFormat](#) record referenced in the following field specifications is the AreaFormat record that exists along with the ShapePropsStream record in one of the following sets of records.

- A sequence of records that conforms to the [FRAME](#) rule.
- A sequence of records that conforms to the DROPBAR rule.
- A sequence of records that conforms to the AXS rule if the field **wObjContext** in the ShapePropsStream record is equal to 0x0003.
- A sequence of records that conforms to the SS rule.
- If the field **wObjContext** in the ShapePropsStream record is equal to 0x0001, then the **foregroundColor** and **backgroundColor** properties are obtained from the [MarkerFormat](#) record in the sequence of records that conforms to the SS rule instead.

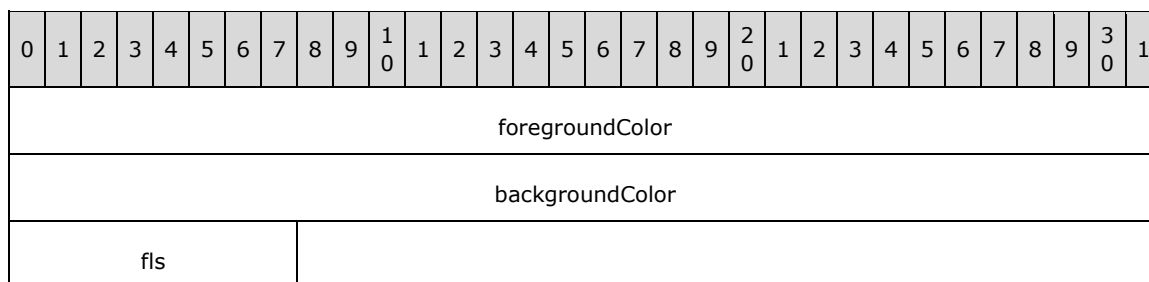

foregroundColor (4 bytes): A [LongRGB](#) that specifies the **foreground color** of the **fill pattern**. MUST equal the value specified by the **rgbFore** field of the related AreaFormat or MarkerFormat records.

backgroundColor (4 bytes): A LongRGB that specifies the **background color** of the fill pattern. MUST equal the value specified by the **rgbBack** field of the related AreaFormat or MarkerFormat records.

fls (1 byte): An unsigned integer that specifies the type of the fill pattern. MUST equal the value specified by the **fls** field of the related AreaFormat record.

2.5.167 ISSTInf

The **ISSTInf** structure is the array element used in the **rgISSTInf** field of the **ExtSST** record. **ib** and **cbOffset** provide a way to access the first string in the set of strings specified by this structure.

0	1	2	3	4	5	6	7	8	9	10	11	12	13	14	15	16	17	18	19	20	21	22	23	24	25	26	27	28	29	30	31
ib																															
cbOffset																reserved															

ib (4 bytes): A FilePointer as specified in [\[MS-OSHARED\]](#) section 2.2.1.5 that specifies the zero-based offset into the [workbook stream](#) where the first string in the set of strings starts.

cbOffset (2 bytes): An unsigned integer that specifies the zero-based offset into the [SST](#) or [Continue](#) record, in which the first string in the set of strings starts. MUST be less than **ib**. The size of the SST or Continue record is determined by reading the record header at the location specified by the following formula:

$$\mathbf{ib} - \mathbf{cbOffset}$$

reserved (2 bytes): MUST be zero, and MUST be ignored.

2.5.168 IXFCeIl

The **IXFCeIl** structure specifies the index of a [cell XF](#).

0	1	2	3	4	5	6	7	8	9	10	11	12	13	14	15	16	17	18	19	20	21	22	23	24	25	26	27	28	29	30	31
ixfe																															

ixfe (2 bytes): An unsigned integer that specifies a zero-based index of a cell XF record in the collection of [XF](#) records in the [Globals Substream](#). Cell XF records are the subset of XF records with an **fStyle** field equal to 0. This value MUST be greater than or equal to 15, or equal to 0. The value 0 indicates that this value MUST be ignored. See [XFIndex](#) for more information about the organization of XF records in the file.

2.5.169 KPIProp

The **KPIProp** enumeration specifies the types of [MDX KPI properties](#).

Name	Value	Meaning
KPIPROPVALUE	0x01	Value.
KPIPROPGOAL	0x02	Goal.
KPIPROPSTATUS	0x03	Status.
KPIPROPTREND	0x04	Trend.
KPIPROPWEIGHT	0x05	Weight.

Name	Value	Meaning
KPIPROPCURRENTTIMEMEMBER	0x06	Current time member (2) .

2.5.170 KPISets

The **KPISets** structure specifies icon sets.

Name	Value	Meaning
KPINIL	0xFFFFFFFF	Sort by no-icon
KPI3ARROWS	0x00000000	Kpi3 Arrows set
KPI3ARROWSGRAY	0x00000001	Kpi3 Arrows Gray set
KPI3FLAGS	0x00000002	Kpi3 Flags set
KPI3TRAFFICLIGHTS1	0x00000003	Kpi3 Traffic Lights 1 set
KPI3TRAFFICLIGHTS2	0x00000004	Kpi3 Traffic Lights 2 set
KPI3SIGNS	0x00000005	Kpi3 Signs set
KPI3SYMBOLS	0x00000006	Kpi3 Symbols set
KPI3SYMBOLS2	0x00000007	Kpi3 Symbols 2 set
KPI4ARROWS	0x00000008	Kpi4 Arrows set
KPI4ARROWSGRAY	0x00000009	Kpi4 Arrows Gray set
KPI4REDTOBLACK	0x0000000A	Kpi4 Red To Black set
KPI4RATING	0x0000000B	Kpi4 Rating set
KPI4TRAFFICLIGHTS	0x0000000C	Kpi4 Traffic Lights set
KPI5ARROWS	0x0000000D	Kpi5 Arrows set
KPI5ARROWSGRAY	0x0000000E	Kpi5 Arrows Gray set
KPI5RATING	0x0000000F	Kpi5 Rating set
KPI5QUARTERS	0x00000010	Kpi5 Quarters set

2.5.171 LbsDropData

The **LbsDropData** structure specifies properties of the dropdown [Obj](#) that contains this LbsDropData.

0	1	2	3	4	5	6	7	8	9	10	11	12	13	14	15	16	17	18	19	20	21	22	23	24	25	26	27	28	29	30	31
A	B	C	unused2													cLine															
dxMin																str (variable)															

...
unused3 (optional)

A - wStyle (2 bits): An unsigned integer that specifies the style of this dropdown. MUST be a value from the following table:

Value	Meaning
0	Combo dropdown control
1	Combo Edit dropdown control
2	Simple dropdown control (just the dropdown button)

B - unused1 (1 bit): Undefined and MUST be ignored.

C - fFiltered (1 bit): A bit that specifies whether the data displayed by the dropdown has been filtered in some way.

unused2 (12 bits): Undefined and MUST be ignored.

cLine (2 bytes): An unsigned integer that specifies the number of lines to be displayed in the dropdown. If there are more lines than that in the list, a scrollbar can appear. MUST be less than or equal to 0x7FFF.

dxMin (2 bytes): An unsigned integer that specifies the smallest width in pixels allowed for the dropdown window. MUST be less than or equal to 0x7FFF.

str (variable): An [XLUnicodeString](#) that specifies the current string value in the dropdown.

unused3 (1 byte): Optional, undefined and MUST be ignored. This field MUST exist if and only if the size of **str** in bytes is an odd number.

2.5.172 LEMMode

The **LEMMode** enumeration specifies the different edit modes for a **table**.

Name	Value	Meaning
LEMNORMAL	0x00000000	The table can be directly edited inline.
LEMREFRESHCOPY	0x00000001	The table is refreshed before editing is allowed because is it a copy of a table whose source is a Web based data provider list.
LEMREFRESHCACHE	0x00000002	The table is refreshed before editing is allowed because caching a user change failed.
LEMREFRESHCACHEUNDO	0x00000003	The table is refreshed before editing is allowed because undoing a cached user change failed.
LEMREFRESHLOADED	0x00000004	The table is refreshed before editing is allowed because on load the table source could not be re-connected.

Name	Value	Meaning
LEMREFRESHTEMPLATE	0x00000005	The table is refreshed before editing is allowed because it was saved without having its data cached.
LEMREFRESHREFRESH	0x00000006	The table is refreshed before editing is allowed because a previous refresh failed.
LEMNOINSROWSSPREQUIRED	0x00000007	Rows cannot be inserted into this web based data provider list because there are hidden required columns.
LEMNOINSROWSSPDOCLIB	0x00000008	Rows cannot be inserted into this Web based data provider list because it is a document library .
LEMREFRESHLOADDISCARDED	0x00000009	The table is refreshed before editing is allowed because the user selected to discard cached changes upon loading.
LEMREFRESHLOADHASHVALIDATION	0x0000000A	The table is refreshed before editing is allowed because the validation of the table's data area failed upon loading.
LEMNOEDITSPMODVIEW	0x0000000B	Cannot allow the user to edit this table because of the type of moderated Web based data provider list it is.

2.5.173 LinePropertiesForShapePropsStreamChecksum

The **LinePropertiesForShapePropsStreamChecksum** record specifies the line properties data used to compute the **checksum** of the [ShapePropsStream](#) record.

The related [LineFormat](#) record referenced in the following field specifications is the LineFormat record that exists along with the ShapePropsStream record in one of the following sets of records.

- A set of records in a [chart group](#) but not in the sequence of records that conforms to the [LD](#) rule or the sequence of records that conforms to the DROPBAR rule.
- If more than one LineFormat and ShapePropsStream records exist in the set, then a pair of LineFormat and ShapePropsStream records are related when the chart element identified by the **ID** field of the [CrtLine](#) record preceding the LineFormat record is the same chart element as the one identified by the **wObjContext** field of the ShapePropsStream record.
- A sequence of records that conforms to the FRAME rule.
- A sequence of records that conforms to the DROPBAR rule.
- A sequence of records that conforms to the AXS rule.
- If more than one LineFormat and ShapePropsStream records exist in the sequence of records, then a pair of LineFormat and ShapePropsStream records are related when the chart element identified by the **ID** field of the [AxisLine](#) record preceding the LineFormat record is be the same chart element as the one identified by the **wObjContext** field of the ShapePropsStream record.
- A sequence of records that conforms to the SS rule when the **wObjContext** field of the ShapePropsStream record is 0x0000.

0	1	2	3	4	5	6	7	8	9	10	11	12	13	14	15	16	17	18	19	20	21	22	23	24	25	26	27	28	29	30	31
icv										pattern						thickness					A	unused									
color																															

icv (1 byte): An [IcvChart](#) that specifies the **palette color** value for the line. The color MUST match the color specified by **color** field. MUST equal the value specified by the **icv** field of the related LineFormat record.

pattern (1 byte): An unsigned integer that specifies the pattern of the line. MUST equal the value specified by the **Ins** field of the related LineFormat record.

thickness (1 byte): A signed integer that specifies the thickness of the line. MUST equal the value specified by the **we** field of the related LineFormat record plus one.

A - fIsLineStyleAutomatic (1 bit): A bit that specifies whether the line has default formatting. MUST contain the value specified by the **fAuto** field of the related LineFormat record.

unused (7 bits): Unused and MUST be zero.

color (4 bytes): A [LongRGB](#) that specifies the color of the line. The color MUST match the color specified by **icv**. MUST equal the value specified by the **rgb** field of the related LineFormat record.

2.5.174 List12BlockLevel

The **List12BlockLevel** structure specifies default **block-level formatting** information for a **table**, to be applied when the table expands. [Style](#) gets applied before [DXFN12List](#) for each table region.

0	1	2	3	4	5	6	7	8	9	10	11	12	13	14	15	16	17	18	19	20	21	22	23	24	25	26	27	28	29	30	31
cbdxHeader																															
istnHeader																															
cbdxData																															
istnData																															
cbdxAgg																															
istnAgg																															
cbdxBorder																															
cbdxHeaderBorder																															
cbdxAggBorder																															
dxHeader (variable)																															

...
dxpData (variable)
...
dxpAgg (variable)
...
dxpBorder (variable)
...
dxpHeaderBorder (variable)
...
dxpAggBorder (variable)
...
stHeader (variable)
...
stData (variable)
...
stAgg (variable)
...

cbdxpHeader (4 bytes): A signed integer that specifies the byte count for **dxpHeader** field. MUST be greater than or equal to zero.

istnHeader (4 bytes): A signed integer that specifies a zero-based index to a Style record in the collection of Style records in the [Globals Substream](#). The referenced Style specifies the [cell style XF](#) used for the table's **header row cells**. If the value is -1, no style is specified for the table's header row cells.

cbdxpData (4 bytes): A signed integer that specifies the byte count for **dxpData** field. MUST be greater than or equal to zero.

istnData (4 bytes): A signed integer that specifies a zero-based index to a Style record in the collection of Style records in the Globals Substream. The referenced Style specifies the [cell style](#) used for the table's data cells. If the value is -1, no style is specified for the table's data cells.

cbdxpAgg (4 bytes): A signed integer that specifies the byte count for **dxpAgg** field. MUST be greater than or equal to zero.

istnAgg (4 bytes): A signed integer that specifies a zero-based index to a Style record in the collection of Style records in the Globals Substream. The referenced Style specifies the cell style used for the table's **total row**. If the value is -1, no style is specified for the table's total row.

cbdxfbBorder (4 bytes): A signed integer that specifies the byte count for **dxfbBorder** field. MUST be greater than or equal to zero.

cbdxfbHeaderBorder (4 bytes): A signed integer that specifies the byte count for **dxfbHeaderBorder** field. MUST be greater than or equal to zero.

cbdxfbAggBorder (4 bytes): A signed integer that specifies the byte count for **dxfbAggBorder** field. MUST be greater than or equal to zero.

dxfbHeader (variable): An optional DXFN12List that specifies the formatting for the table's header row cells. MUST exist if and only if **cbdxfbHeader** is nonzero.

dxfbData (variable): An optional DXFN12List that specifies the formatting for the table's data cells. MUST exist if and only if **cbdxfbData** is nonzero.

dxfbAgg (variable): An optional DXFN12List that specifies the formatting for the table's total row. MUST exist if and only if **cbdxfbAgg** is nonzero.

dxfbBorder (variable): An optional DXFN12 that specifies the formatting for the **border** of the table's data cells. MUST exist if and only if **cbdxfbBorder** is nonzero.

dxfbHeaderBorder (variable): An optional DXFN12List that specifies the formatting for the border of the table's header row cells. MUST exist if and only if **cbdxfbHeaderBorder** is nonzero.

dxfbAggBorder (variable): An optional DXFN12List that specifies the formatting for the border of the table's total row. MUST exist if and only if **cbdxfbAggBorder** is nonzero.

stHeader (variable): An optional [XLUnicodeString](#) that specifies the name of the **style** for the table's header row cells. MUST exist if and only if **istnHeader** is not equal to -1. MUST be equal to the name of the Style record specified by **istnHeader**. If the style is a user-defined style, **stHeader** MUST be equal to the **user** field of the Style record.

stData (variable): An optional XLUnicodeString that specifies the name of the style for the table's data cells. MUST exist if and only if **istnData** is not equal to -1. MUST be equal to the name of the Style record specified by **istnData**. If the style is a user-defined style, **stData** MUST be equal to the **user** field of the Style record.

stAgg (variable): An optional XLUnicodeString that specifies the name of the style for the table's total row. MUST exist if and only if **istnAgg** is not equal to -1. MUST be equal to the name of the Style record specified by **istnAgg**. If the style is a user-defined style, **stAgg** MUST be equal to the **user** field of the Style record.

2.5.175 List12DisplayName

The **List12DisplayName** structure specifies the name and comment strings for the **table**.

0	1	2	3	4	5	6	7	8	9	10	11	12	13	14	15	16	17	18	19	20	21	22	23	24	25	26	27	28	29	30	31
stListName (variable)																															
...																															
stListComment (variable)																															

...

stListName (variable): An [XLNameUnicodeString](#) that specifies the table name. MUST be an empty string if the **rgbName** field of the [TableFeatureType](#) structure embedded in the [Feature11](#) or [Feature12](#) record that specifies the table is not empty. If the table name is not the same as the **rgbName** field of the [TableFeatureType](#) structure for this table, the table name is specified in **stListName** which is a case-insensitive unique name among all table names and **defined names** in the **workbook**.

stListComment (variable): An [XLUnicodeString](#) that specifies a comment about the table.

2.5.176 List12TableStyleClientInfo

The **List12TableStyleClientInfo** record specifies information about the style applied to a **table**.

0	1	2	3	4	5	6	7	8	9	10	11	12	13	14	15	16	17	18	19	20	21	22	23	24	25	26	27	28	29	30	31
A	B	C	D	E	F	unused2									stListStyleName (variable)																
...																															

A - fFirstColumn (1 bit): A bit that specifies whether any [table style elements](#) (as specified by [TableStyleElement](#)) with a **tseType** field equal to 0x00000003 will be applied.

B - fLastColumn (1 bit): A bit that specifies whether any table style elements (as specified by [TableStyleElement](#)) with a **tseType** field equal to 0x00000004 will be applied.

C - fRowStripes (1 bit): A bit that specifies whether any table style elements (as specified by [TableStyleElement](#)) with a **tseType** field equal to 0x00000005 or 0x00000006 will be applied.

D - fColumnStripes (1 bit): A bit that specifies whether any table style elements (as specified by [TableStyleElement](#)) with a **tseType** field equal to 0x00000007 or 0x00000008 will be applied.

E - unused1 (2 bits): Undefined and MUST be ignored.

F - fDefaultStyle (1 bit): A bit that specifies whether the style whose name is specified by **stListStyleName** is the default [table style](#).

unused2 (9 bits): Undefined and MUST be ignored.

stListStyleName (variable): An [XLUnicodeString](#) that specifies the name of the table style for the table. Length MUST be greater than zero and less than or equal to 255 characters. If the table style is a custom style, it is defined in a [TableStyle](#) record that has **rgchName** equal to this value.

2.5.177 LongRGB

The **LongRGB** structure specifies a color as a combination of red, green, and blue.

0	1	2	3	4	5	6	7	8	9	10	11	12	13	14	15	16	17	18	19	20	21	22	23	24	25	26	27	28	29	30	31
red								green								blue								reserved							

red (1 byte): An unsigned integer that specifies the relative intensity of red.

green (1 byte): An unsigned integer that specifies the relative intensity of green.

blue (1 byte): An unsigned integer that specifies the relative intensity of blue.

reserved (1 byte): MUST be zero, and MUST be ignored.

2.5.178 LongRGBA

The **LongRGBA** structure specifies a color as a combination of red, green, blue and alpha values.

0	1	2	3	4	5	6	7	8	9	10	11	12	13	14	15	16	17	18	19	20	21	22	23	24	25	26	27	28	29	30	31								
red										green										blue										alpha									

red (1 byte): An unsigned integer that specifies the relative intensity of red.

green (1 byte): An unsigned integer that specifies the relative intensity of green.

blue (1 byte): An unsigned integer that specifies the relative intensity of blue.

alpha (1 byte): An unsigned integer that specifies the alpha value.

2.5.179 LPWideString

The **LPWideString** type specifies a **Unicode** string which is prefixed by a length.

0	1	2	3	4	5	6	7	8	9	10	11	12	13	14	15	16	17	18	19	20	21	22	23	24	25	26	27	28	29	30	31					
cchCharacters																	rgchData (variable)																			
...																																				

cchCharacters (2 bytes): An unsigned integer that specifies the number of characters.

rgchData (variable): An array of Unicode characters that specifies the characters of the string. The size of this array in bytes MUST equal the following formula:

cchCharacters * 2

2.5.180 MDir

The **MDir** structure specifies the [MDTInfoIndex](#) and the index of a specific [MDX metadata](#) record.

0	1	2	3	4	5	6	7	8	9	10	11	12	13	14	15	16	17	18	19	20	21	22	23	24	25	26	27	28	29	30	31
imdt																															
mdd																															

imdt (4 bytes): An MDTInfoIndex that identifies the [MDTInfo](#) record.

mdd (4 bytes): An unsigned integer that specifies the zero-based index of an MDX metadata record in the collection of MDX metadata records in the [Globals Substream](#). The referenced record specifies a MDX metadata record corresponding to the record type specified by **imdt**. The MDX metadata records include [MDXTuple](#), [MDXSet](#), [MDXProp](#) and [MDXKPI](#) records.

2.5.181 MDTInfoIndex

The **MDTInfoIndex** structure specifies an index which identifies an [MDTInfo](#) record.

0	1	2	3	4	5	6	7	8	9	10	1	2	3	4	5	6	7	8	9	20	1	2	3	4	5	6	7	8	9	30	1
index																															

index (4 bytes): A signed integer that specifies the one-based index of an MDTInfo record in the collection of MDTInfo records in the [Globals Substream](#). The value MUST be greater than 0 and less than or equal to the total number of the MDTInfo records in the file.

2.5.182 MDXStrIndex

The **MDXStrIndex** structure specifies the index of an [MDXStr](#) record.

0	1	2	3	4	5	6	7	8	9	10	1	2	3	4	5	6	7	8	9	20	1	2	3	4	5	6	7	8	9	30	1
index																															

index (4 bytes): A signed integer that specifies the zero-based index of an MDXStr record in the collection of MDXStr records in the [Globals Substream](#). The value MUST be greater than or equal to 0 and less than the total number of the MDXStr records that have been read so far.

2.5.183 MOper

The **MOper** structure specifies multiple operands of an **OLE link** or a **DDE link** for the [ExternOleDdeLink](#) structure.

0	1	2	3	4	5	6	7	8	9	10	1	2	3	4	5	6	7	8	9	20	1	2	3	4	5	6	7	8	9	30	1
colLast										rowLast										extOper (variable)											
...																															

colLast (1 byte): A [ColByteU](#) that specifies the zero-based index of last column associated with the link.

rowLast (2 bytes): A [RwU](#) that specifies the zero-based index of last row associated with the link.

extOper (variable): This array specifies current values for the linked data. Each [SerAr](#) specifies a cell value. The number of elements in the array is

$$(\text{colLast} + 1) * (\text{rowLast} + 1).$$

If this array does not fit in the owning [ExternName](#) record, [Continue](#) records are used. Each SerAr MUST stay in the same record.

2.5.184 NilChartNum

The **NilChartNum** structure specifies a non-numeric value (also known as "NaN" or "Not a Number") that is used in place of a numeric value.

0	1	2	3	4	5	6	7	8	9	10	11	12	13	14	15	16	17	18	19	20	21	22	23	24	25	26	27	28	29	30	31
unused																															
type																reserved															

unused (4 bytes): Undefined and MUST be ignored.

type (2 bytes): An unsigned integer that specifies the interpretation of this value. This field is undefined and MUST be ignored, unless otherwise defined by the containing record.

reserved (2 bytes): MUST be 0xFFFF and MUST be ignored.

2.5.185 NoteRR

The **NoteRR** structure specifies a [revision record](#) for a **comment** associated with a **cell**.

0	1	2	3	4	5	6	7	8	9	10	11	12	13	14	15	16	17	18	19	20	21	22	23	24	25	26	27	28	29	30	31
rrd (14 bytes)																															
...																															
...																															
...																A	B	reserved1													
row																col															
C	D	reserved3				E	F	G	H	I				guid (16 bytes)																	
...																															
...																															
...																ichEnd															
...																cchNote															
...																stAuthor (variable)															
...																															
unused2																															

rrd (14 bytes): An [RRD](#) that specifies the [revision record](#) information used to track changes in a [shared workbook](#). The **rrd.rev** MUST be equal to 0x000D. The **rrd.tabid** MUST NOT be 0xFFFF.

A - bitfDelNote (1 bit): A bit that specifies whether the revision record deletes the comment.

B - bitfAddNote (1 bit): A bit that specifies whether the revision record adds text to the comment.

Value	Meaning
0	Text has not been added to the comment.
1	A new comment is being added or additional text is being appended to an existing comment.

reserved1 (14 bits): MUST be 0 and MUST be ignored.

row (2 bytes): A [RwU](#) that specifies the row of the cell associated with the comment.

col (2 bytes): A [ColU](#) that specifies the column of the cell associated with the comment.

C - reserved2 (1 bit): MUST be 0 and MUST be ignored.

D - fShow (1 bit): A bit that specifies whether the comment is shown.

reserved3 (5 bits): MUST be 0 and MUST be ignored.

E - fRwHidden (1 bit): A bit that specifies whether the row specified by **row** is **hidden**.

F - fColHidden (1 bit): A bit that specifies whether the column specified by **col** is hidden.

G - reserved4 (2 bits): MUST be 0 and MUST be ignored.

H - unused1 (1 bit): Unused and MUST be ignored.

I - reserved5 (4 bits): MUST be 0 and MUST be ignored.

guid (16 bytes): A **GUID** as specified by [\[MS-DTYP\]](#) that identifies the comment, specified by a [NoteSh](#) structure, which is modified by this revision record. The GUID for a comment is specified in the [Obj](#) record specified by the **idObj** field in the NoteSh structure. In the Obj record, the GUID is stored in the **nts.guid** field. If **bitfDelNote** is 1, this field MUST be zero.

ichEnd (4 bytes): An unsigned integer that specified the length of the comment before the revision is made.

cchNote (4 bytes): An unsigned integer that specifies the length of the string that was added to the comment in the revision record. The sum of **ichEnd** and **cchNote** MUST be less than or equal to 32767.

stAuthor (variable): An [XLUnicodeString](#) that specifies the original author of the comment. The length MUST be greater than or equal to 1 and less than or equal to 54.

unused2 (2 bytes): Undefined and MUST be ignored.

2.5.186 NoteSh

The **NoteSh** structure specifies a **comment** associated with a **cell**.

0	1	2	3	4	5	6	7	8	9	10	11	12	13	14	15	16	17	18	19	20	21	22	23	24	25	26	27	28	29	30	31
row														col																	
A	B	C	D	E			F	G	reserved4							idObj															
stAuthor (variable)																															
...																															
unused2																															

row (2 bytes): A [RW](#) that specifies the row of the cell to which this comment is associated.

col (2 bytes): A [Col](#) that specifies the column of the cell to which this comment is associated.

A - reserved1 (1 bit): MUST be zero and MUST be ignored.

B - fShow (1 bit): A bit that specifies whether the comment is shown at all times.

C - reserved2 (1 bit): MUST be zero and MUST be ignored.

D - unused1 (1 bit): Undefined and MUST be ignored.

E - reserved3 (3 bits): MUST be zero and MUST be ignored.

F - fRwHidden (1 bit): A bit that specifies whether the row specified by **row** is **hidden**.

G - fColHidden (1 bit): A bit that specifies whether the column specified by **col** is hidden.

reserved4 (7 bits): MUST be zero and MUST be ignored.

idObj (2 bytes): An [ObjId](#) that specifies the [Obj](#) record that specifies the comment text.

stAuthor (variable): An [XLUnicodeString](#) that specifies the name of the comment author. String length MUST be greater than or equal to 1 and less than or equal to 54.

unused2 (1 byte): Undefined and MUST be ignored.

2.5.187 ObjFmla

The **ObjFmla** structure specifies a formula (section [2.2.2](#)) in an [Obj](#) record.

0	1	2	3	4	5	6	7	8	9	10	11	12	13	14	15	16	17	18	19	20	21	22	23	24	25	26	27	28	29	30	31
cbFmla																fmla (variable)															
...																															
embedInfo (variable)																															
...																															

padding (variable)
...

cbFmla (2 bytes): An unsigned integer that specifies the number of bytes in this ObjFmla, not counting the two bytes of the **cbFmla** field itself. This number MUST be even.

fmla (variable): An optional [ObjectParsedFormula](#) that specifies the formula. This field MUST exist if and only if **cbFmla** is greater than 0x0000.

embedInfo (variable): An optional [PictFmlaEmbedInfo](#). This field MUST exist if and only if the structure containing this ObjFmla is an [FtPictFmla](#), the **fmla** field exists, and the **fmla.rgce** field starts with a [PtqTbl](#).

padding (variable): An array of bytes whose size is given by: **cbFmla** minus size of **fmla** minus size of **embedInfo**.

It is possible for this array to be empty. The value of the elements in this array are undefined and MUST be ignored.

2.5.188 ObjId

The **ObjId** structure specifies a reference to an [Obj](#).

0	1	2	3	4	5	6	7	8	9	10	11	12	13	14	15	16	17	18	19	20	21	22	23	24	25	26	27	28	29	30	31
id																															

id (2 bytes): An unsigned integer that specifies the value of the **cmo.id** field of an Obj in the same [drawing](#). A value of 0 specifies that this ObjId does not reference an Obj.

2.5.189 ObjLinkFmla

The **ObjLinkFmla** structure specifies the formula (section [2.2.2](#)) that specifies a **range** which contains a value that is linked to the control represented by the [Obj](#) record containing this ObjLinkFmla.

0	1	2	3	4	5	6	7	8	9	10	11	12	13	14	15	16	17	18	19	20	21	22	23	24	25	26	27	28	29	30	31
ft																fmla (variable)															
...																															

ft (2 bytes): Reserved. MUST be 0x0014 if the **cmo.ot** of the containing Obj is equal to 0x0B or 0x0C. MUST be 0x000E if the **cmo.ot** field of the containing Obj is equal to 0x10, 0x11, 0x12, or 0x14. Note that this ObjLinkFmla MUST NOT exist if **cmo.ot** is any other value.

fmla (variable): An [ObjFmla](#) that specifies the formula which specifies a range which contains a value that is linked to the state of the control.

2.5.190 ODBCType

The **ODBCType** structure specifies an **ODBC** data type identifier.

0	1	2	3	4	5	6	7	8	9	10	11	12	13	14	15	16	17	18	19	20	21	22	23	24	25	26	27	28	29	30	31
wTypeSql																															

wTypeSql (2 bytes): A signed integer that specifies an ODBC data type. The following are example data types supported by ODBC. For more information about ODBC, see [\[MSDN-OpenDBConnectivity\]](#).

Value	SQL Type	Data Type
0x0000	SQL_TYPE_NULL	Undetermined type, data source does not support typed data. Data type determined based on data content: date and time, decimal or text.
0x0001	SQL_CHAR	Fixed-length string of ANSI characters
0x0003	SQL_DECIMAL	Fixed-precision, Fixed-scale numbers
0x0004	SQL_INTEGER	32-bit signed integer
0x0005	SQL_SMALLINT	16-bit signed integer
0x0006	SQL_FLOAT	User-specified precision floating-point
0x0007	SQL_REAL	7-digits precision floating-point
0x0008	SQL_DOUBLE	15-digits precision floating-point
0x000B	SQL_TIMESTAMP	Date and Time
0x000C	SQL_VARCHAR	Variable-length string of ANSI characters
0xFFFF9	SQL_BIT	Bit (1 or 0)
0xFFFE	SQL_BINARY	Fixed-length binary data

2.5.191 OfficeArtClientAnchorChart

The **OfficeArtClientAnchorChart** structure specifies the anchor position of a **drawing object** embedded in a [chart](#).

0	1	2	3	4	5	6	7	8	9	10	11	12	13	14	15	16	17	18	19	20	21	22	23	24	25	26	27	28	29	30	31
rh																															
...																															
A	B	C	D	E	unused											lx1															

...	ly1
...	lx2
...	ly2
...	

rh (8 bytes): An OfficeArtRecordHeader as specified in [\[MS-ODRAW\]](#) section 2.2.1 that specifies the header for this structure. **rh.recVer** MUST be 0x0. **rh.recInstance** MUST be 0x0. **rh.recType** MUST be 0xF010. **rh.recLen** MUST be 0x0012.

A - fMove (1 bit): MUST be 0 and MUST be ignored.

B - fSize (1 bit): A bit that specifies whether the drawing object resizes with the **chart area** (section [2.2.3.17](#)). MUST be a value from the following table:

Value	Meaning
0x0	The drawing object resizes with the chart area (section 2.2.3.17).
0x1	The drawing object does not resize with the chart area (section 2.2.3.17).

C - reserved1 (1 bit): MUST be 0 and MUST be ignored.

D - reserved2 (1 bit): Undefined and MUST be ignored.

E - reserved3 (1 bit): MUST be 0 and MUST be ignored.

unused (11 bits): Undefined and MUST be ignored.

lx1 (4 bytes): A signed integer that specifies the horizontal offset of the logical upper-left corner of the **bounding rectangle** of the drawing object, relative to the upper-left corner of the chart area (section 2.2.3.17) in [SPRC](#).

ly1 (4 bytes): A signed integer that specifies the vertical offset of the logical upper-left corner of the bounding rectangle of the drawing object, relative to the upper-left corner of the chart area (section 2.2.3.17) in [SPRC](#).

lx2 (4 bytes): A signed integer that specifies the horizontal offset of the logical bottom-right corner of the bounding rectangle of the drawing object, relative to the upper-left corner of the chart area (section 2.2.3.17) in [SPRC](#).

ly2 (4 bytes): A signed integer that specifies the vertical offset of the logical bottom-right corner of the bounding rectangle of the drawing object, relative to the upper-left corner of the chart area (section 2.2.3.17) in [SPRC](#).

2.5.192 OfficeArtClientAnchorHF

The **OfficeArtClientAnchorHF** structure specifies the dimension information of a picture specified in a [HFPicture](#) record.

0	1	2	3	4	5	6	7	8	9	10	11	12	13	14	15	16	17	18	19	20	21	22	23	24	25	26	27	28	29	30	31
rh																															
...																															
width																															
height																															

rh (8 bytes): An OfficeArtRecordHeader as specified in [\[MS-ODRAW\]](#) that specifies the header for this structure. The sub-fields of OfficeArtRecordHeader are further specified in the following table:

Field	Meaning
rh.recVer	MUST be 0x0.
rh.recInstance	MUST be 0x0.
rh.recType	MUST be 0xF010.
rh.recLen	MUST be 8.

width (4 bytes): A signed integer that specifies the width of the picture in pixels. This value MUST be greater than 0.

height (4 bytes): A signed integer that specifies the height of the picture in pixels. This value MUST be greater than 0.

2.5.193 OfficeArtClientAnchorSheet

The **OfficeArtClientAnchorSheet** structure specifies the anchor position of a **drawing object** embedded in a **sheet**.

0	1	2	3	4	5	6	7	8	9	10	11	12	13	14	15	16	17	18	19	20	21	22	23	24	25	26	27	28	29	30	31
rh																															
...																															
A	B	C	D	E	unused																colL										
dxL																rwT															
dyT																colR															
dxR																rwB															
dyB																															

rh (8 bytes): An OfficeArtRecordHeader as defined in [\[MS-ODRAW\]](#) that specifies the header for this structure. The sub-fields of OfficeArtRecordHeader are further specified in the following table:

Field	Meaning
rh.recVer	MUST be 0x0.
rh.recInstance	MUST be 0x0.
rh.recType	MUST be 0xF010.
rh.recLen	An unsigned integer that specifies the number of bytes following the header. The value MUST be equal to 18.

A - fMove (1 bit): A bit that specifies whether the **shape** will be kept intact when the **cells** are moved.

B - fSize (1 bit): A bit that specifies whether the shape will be kept intact when the cells are resized. If **fMove** is 1, the value MUST be 1.

C - reserved1 (1 bit): MUST be 0 and MUST be ignored.

D - reserved2 (1 bit): MUST be 0 and MUST be ignored

E - reserved3 (1 bit): MUST be 0 and MUST be ignored.

unused (11 bits): Undefined and MUST be ignored.

colL (2 bytes): A [Col256U](#) that specifies the column of the cell under the top left corner of the **bounding rectangle** of the shape.

dxL (2 bytes): A signed integer that specifies the x coordinate of the top left corner of the bounding rectangle relative to the corner of the underlying cell. The value is expressed as 1024th's of that cell's width.

rwT (2 bytes): A [RwU](#) that specifies the row of the cell under the top left corner of the bounding rectangle of the shape.

dyT (2 bytes): A signed integer that specifies the y coordinate of the top left corner of the bounding rectangle relative to the corner of the underlying cell. The value is expressed as 256th's of that cell's height.

colR (2 bytes): A [Col256U](#) that specifies the column of the cell under the bottom right corner of the bounding rectangle of the shape.

dxR (2 bytes): A signed integer that specifies the x coordinate of the bottom right corner of the bounding rectangle relative to the corner of the underlying cell. The value is expressed as 1024th's of that cell's width.

rwB (2 bytes): A [RwU](#) that specifies the row of the cell under the bottom right corner of the bounding rectangle of the shape.

dyB (2 bytes): A signed integer that specifies the y coordinate of the bottom right corner of the bounding rectangle relative to the corner of the underlying cell. The value is expressed as 256th's of that cell's height.

2.5.194 OfficeArtClientData

The **OfficeArtClientData** structure specifies the client data of an **drawing object**. MUST be the last structure of the **rgChildRec** field of the current [MsoDrawing](#) record. And the next record MUST be [Obj](#), which contains the detailed data information about this drawing object.

0	1	2	3	4	5	6	7	8	9	1	0	1	2	3	4	5	6	7	8	9	2	0	1	2	3	4	5	6	7	8	9	3	0	1
rh																																		
...																																		

rh (8 bytes): An OfficeArtRecordHeader as specified in [\[MS-ODRAW\]](#) section 2.2.1 that specifies the header for this structure. The subfields of OfficeArtRecordHeader are further specified in the following table:

Field	Meaning
rh.recVer	MUST be 0x0.
rh.recInstance	MUST be 0x0.
rh.recType	MUST be 0xF011.
rh.recLen	An unsigned integer that specifies the number of bytes following the header. The value MUST be equal to 0.

2.5.195 OfficeArtClientTextbox

The **OfficeArtClientTextbox** structure specifies the client textbox of an **drawing object**. MUST be the last structure of the **rgChildRec** field of the **MsoDrawing** record. And the next record MUST be **TxO**, which contains the detailed textbox information about this drawing object.

0	1	2	3	4	5	6	7	8	9	1	0	1	2	3	4	5	6	7	8	9	2	0	1	2	3	4	5	6	7	8	9	3	0	1
rh																																		
...																																		

rh (8 bytes): An OfficeArtRecordHeader as specified in [\[MS-ODRAW\]](#) section 2.2.1 that specifies the header for this structure. The subfields of OfficeArtRecordHeader are further specified in the following table:

Field	Meaning
rh.recVer	MUST be 0x0.
rh.recInstance	MUST be 0x0.
rh.recType	MUST be 0xF00D.
rh.recLen	An unsigned integer that specifies the number of bytes following the header. The value MUST be equal to 0.

2.5.196 PaneType

The **PaneType** enumeration specifies the different types of **panes**.

Name	Value	Meaning
REVPNNBOTRIGHT	0x00	logical bottom-right pane
REVPNNTOPRIGHT	0x01	logical top-right pane
REVPNNBOTLEFT	0x02	logical bottom-left pane
REVPNNTOPLEFT	0x03	logical top-left pane

2.5.197 PARAMQRY_Fixed

PARAMQRY_Fixed structure contains information about **SQL** query parameters.

0	1	2	3	4	5	6	7	8	9	10	11	12	13	14	15	16	17	18	19	20	21	22	23	24	25	26	27	28	29	30	31
wTypeSql																pbt		A	B	unused2											
grbit																fVal															

wTypeSql (2 bytes): An [ODBCType](#) structure that specifies the SQL data type.

pbt (2 bits): An unsigned integer that specifies the parameter type. MUST be a value from the following table:

Value	Meaning
0	Prompt. User is prompted for the value of the parameter.
1	Value. The parameter value is specified in the query.
2	Reference. The parameter value is specified in a cell.

A - unused1 (1 bit): Undefined and MUST be ignored.

B - fNonDefaultName (1 bit): A bit that specifies whether to use the default prompt if **pbt** is equal to 0. MUST be a value from the following table:

Value	Meaning
0	User entered prompt is used
1	Application's default prompt is used

unused2 (12 bits): Undefined and MUST be ignored.

grbit (2 bytes): An unsigned integer that specifies the type of data that follows this structure as specified in the following table or the presence of a Boolean value in **fVal** if **pbt** equals 1. MUST be a value from the following table if **pbt** equals 1:

Value	Meaning
0x001	Xnum (section 2.5.342)
0x002	SXString

Value	Meaning
0x004	Boolean (section 2.5.14) value in fVal .
0x800	4 byte unsigned integer

fVal (2 bytes): A Boolean that specifies value such that if **pbt** equals 1 and **grbit** equals 4. MUST be equal to 0 or 1 if **pbt** equals 1 and **grbit** equals 4. MUST be ignored if **pbt** is not equal to 1 or **grbit** is not equal to 4.

2.5.198 Parsed Expressions

2.5.198.1 ArrayParsedFormula

The **ArrayParsedFormula** structure specifies an array formula (section [2.2.2](#)).

0	1	2	3	4	5	6	7	8	9	10	11	12	13	14	15	16	17	18	19	20	21	22	23	24	25	26	27	28	29	30	31
cce																rgce (variable)															
...																															
rgcb (variable)																															
...																															

cce (2 bytes): An unsigned integer that specifies the length of **rgce** in bytes. MUST be greater than 0.

rgce (variable): An [Rgce](#) that specifies the sequence of Ptgs for the formula (section [2.2.2](#)). MUST NOT contain [PtgExp](#), [PtgTbl](#), [PtgRefN](#), [PtgAreaN](#), or [PtgSxName](#).

rgcb (variable): An [RgbExtra](#) that specifies ancillary data for the formula.

2.5.198.2 BErr

The **BErr** structure is a 1 byte unsigned integer that specifies an error. MUST be a value from the following table:

Value	Meaning
0x00	#NULL!
0x07	#DIV/0!
0x0F	#VALUE!
0x17	#REF!
0x1D	#NAME?
0x24	#NUM!
0x2A	#N/A

2.5.198.3 CellParsedFormula

The **CellParsedFormula** structure specifies a formula (section 2.2.2) stored in a **cell**.

0	1	2	3	4	5	6	7	8	9	10	11	12	13	14	15	16	17	18	19	20	21	22	23	24	25	26	27	28	29	30	31
cce																rgce (variable)															
...																															
rgcb (variable)																															
...																															

cce (2 bytes): An unsigned integer that specifies the length of **rgce** in bytes. MUST be greater than 0.

rgce (variable): An [Rgce](#) that specifies the sequence of Ptgs for the formula. MUST NOT contain [PtgRefN](#), [PtgAreaN](#), or [PtgSxName](#).

The root node of the parse tree of this field MUST be a VALUE_TYPE, as described in Rgce.

rgcb (variable): An [RgbExtra](#) that specifies ancillary data for the formula.

2.5.198.4 Cetab

The **Cetab** structure specifies a function that can be called from a formula (section 2.2.2). The definition of each function specifies the function name and the valid sequence of arguments.

0	1	2	3	4	5	6	7	8	9	10	11	12	13	14	15	16	17	18	19	20	21	22	23	24	25	26	27	28	29	30	31
cetab																															

cetab (2 bytes): An unsigned integer that specifies the function to be called. MUST be a value from the following table:

The elements [ref](#) and [val](#) are specified in Rgce.

Value	Meaning
0x0000	BEEP
	beep-params = [val]
0x0001	OPEN
	open-params = *17(val)
0x0002	OPEN.LINKS
	open-links-params = *15(val)
0x0003	CLOSE.ALL

Value	Meaning
	This function takes no parameters
0x0004	SAVE
	This function takes no parameters
0x0005	SAVE.AS
	save-as-params = *7(val)
0x0006	FILE.DELETE
	file-delete-params = [val]
0x0007	PAGE.SETUP
	page-setup-params = *30(val)
0x0008	PRINT
	print-params = *17(val)
0x0009	PRINTER.SETUP
	printer-setup-params = [val]
0x000A	QUIT
	This function takes no parameters
0x000B	NEW.WINDOW
	This function takes no parameters
0x000C	ARRANGE.ALL
	arrange-All-params = *4(val)
0x000D	WINDOW.SIZE
	window-size-params = *3(val)
0x000E	WINDOW.MOVE
	window-move-params = *3(val)
0x000F	FULL
	full-params = [val]
0x0010	CLOSE
	close-params = *2(val)
0x0011	RUN
	run-params = [(ref / val), [val]]
0x0016	SET.PRINT.AREA
	set-print-area-params = [ref / val]
0x0017	SET.PRINT.TITLES

Value	Meaning
	set-print-titles-params = *2(ref / val)
0x0018	SET.PAGE.BREAK
	This function takes no parameters
0x0019	REMOVE.PAGE.BREAK
	remove-page-break-params = *2(val)
0x001A	FONT
	font-params = *2(val)
0x001B	DISPLAY
	display-params = *9(val)
0x001C	PROTECT.DOCUMENT
	protect-document-params = *7(val)
0x001D	PRECISION
	precision-params = [val]
0x001E	A1.R1C1
	a1-r1c1-params = [val]
0x001F	CALCULATE.NOW
	This function takes no parameters
0x0020	CALCULATION
	calculation-params = *11(val)
0x0022	DATA.FIND
	data-find-params = [val]
0x0023	EXTRACT
	extract-params = [val]
0x0024	DATA.DELETE
	This function takes no parameters
0x0025	SET.DATABASE
	This function takes no parameters
0x0026	SET.CRITERIA
	This function takes no parameters
0x0027	SORT
	sort-params = [val, [(ref / val), [(ref / val), [(ref / val), [(ref / val), [(ref / val), [(ref / val), [(ref / val), [(ref / val), *10(val)]]]]]]]]]]]
0x0028	DATA.SERIES

Value	Meaning
	data-series-params = *6(val)
0x0029	TABLE
	table-params = *2(ref / val)
0x002A	FORMAT.NUMBER
	format-number-params = [val]
0x002B	ALIGNMENT
	alignment-params = *10(val)
0x002C	STYLE
	style-params = *2(val)
0x002D	BORDER
	border-params = *27(val)
0x002E	CELL.PROTECTION
	cell-protection-params = *2(val)
0x002F	COLUMN.WIDTH
	column-width-params = [val, *4(ref / val)]
0x0030	UNDO
	This function takes no parameters
0x0031	CUT
	cut-params = *2(ref / val)
0x0032	COPY
	copy-params = *2(ref / val)
0x0033	PASTE
	paste-params = [ref / val]
0x0034	CLEAR
	clear-params = [val]
0x0035	PASTE.SPECIAL
	paste-special-params = *7(val)
0x0036	EDIT.DELETE
	edit-delete-params = [val]
0x0037	INSERT
	insert-params = *2(val)
0x0038	FILL.RIGHT

Value	Meaning
	This function takes no parameters
0x0039	FILL.DOWN
	This function takes no parameters
0x003D	DEFINE.NAME
	define-name-params = [val, [(ref / val), [(ref / val), [(ref / val), [(ref / val), [(ref / val), [(ref / val), [val]]]]]]]]
0x003E	CREATE.NAMES
	create-names-params = *4(val)
0x003F	FORMULA.GOTO
	formula-goto-params = [(ref / val), [val]]
0x0040	FORMULA.FIND
	formula-find-params = *12(val)
0x0041	SELECT.LAST.CELL
	This function takes no parameters
0x0042	SHOW.ACTIVE.CELL
	This function takes no parameters
0x0043	GALLERY.AREA
	gallery-area-params = *2(val)
0x0044	GALLERY.BAR
	gallery-bar-params = *2(val)
0x0045	GALLERY.COLUMN
	gallery-column-params = *2(val)
0x0046	GALLERY.LINE
	gallery-line-params = *2(val)
0x0047	GALLERY.PIE
	gallery-pie-params = *2(val)
0x0048	GALLERY.SCATTER
	gallery-scatter-params = *2(val)
0x0049	COMBINATION
	combination-params = [val]
0x004A	PREFERRED
	This function takes no parameters
0x004B	ADD.OVERLAY

Value	Meaning
	This function takes no parameters
0x004C	GRIDLINES
	gridlines-params = *7(val)
0x004D	SET.PREFERRED
	set-preferred-params = [val]
0x004E	AXES
	axes-params = *6(val)
0x004F	LEGEND
	legend-params = [val]
0x0050	ATTACH.TEXT
	attach-text-params = *3(val)
0x0051	ADD.ARROW
	This function takes no parameters
0x0052	SELECT.CHART
	This function takes no parameters
0x0053	SELECT.PLOT.AREA
	This function takes no parameters
0x0054	PATTERNS
	patterns-params = *13(val)
0x0055	MAIN.CHART
	main-chart-params = *10(val)
0x0056	OVERLAY
	overlay-params = *12(val)
0x0057	SCALE
	scale-params = *10(val)
0x0058	FORMAT.LEGEND
	format-legend-params = [val]
0x0059	FORMAT.TEXT
	format-text-params = *11(val)
0x005A	EDIT.REPEAT
	This function takes no parameters
0x005B	PARSE

Value	Meaning
	parse-params = [val, [ref / val]]
0x005C	JUSTIFY
	This function takes no parameters
0x005D	HIDE
	This function takes no parameters
0x005E	UNHIDE
	unhide-params = [val]
0x005F	WORKSPACE
	workspace-params = *16(val)
0x0060	FORMULA
	formula-params = [val, [ref / val]]
0x0061	FORMULA.FILL
	formula-fill-params = [val, [ref / val]]
0x0062	FORMULA.ARRAY
	formula-array-params = [val, [ref / val]]
0x0063	DATA.FIND.NEXT
	This function takes no parameters
0x0064	DATA.FIND.PREV
	This function takes no parameters
0x0065	FORMULA.FIND.NEXT
	This function takes no parameters
0x0066	FORMULA.FIND.PREV
	This function takes no parameters
0x0067	ACTIVATE
	activate-params = *2(val)
0x0068	ACTIVATE.NEXT
	activate-next-params = [val]
0x0069	ACTIVATE.PREV
	activate-prev-params = [val]
0x006A	UNLOCKED.NEXT
	This function takes no parameters
0x006B	UNLOCKED.PREV

Value	Meaning
	This function takes no parameters
0x006C	COPY.PICTURE
	copy-picture-params = *3(val)
0x006D	SELECT
	select-params = *2(ref / val)
0x006E	DELETE.NAME
	delete-name-params = [val]
0x006F	DELETE.FORMAT
	delete-format-params = [val]
0x0070	VLIN
	vline-params = [val]
0x0071	HLIN
	hline-params = [val]
0x0072	VPAGE
	vpage-params = [val]
0x0073	HPAGE
	hpage-params = [val]
0x0074	VSCROLL
	vscroll-params = *2(val)
0x0075	HSCROLL
	hscroll-params = *2(val)
0x0076	ALERT
	alert-params = *3(val)
0x0077	NEW
	new-params = *3(val)
0x0078	CANCEL.COPY
	cancel-copy-params = [val]
0x0079	SHOW.CLIPBOARD
	This function takes no parameters
0x007A	MESSAGE
	message-params = *2(val)
0x007C	PASTE.LINK

Value	Meaning
	This function takes no parameters
0x007D	APP.ACTIVATE
	app-activate-params = *2(val)
0x007E	DELETE.ARROW
	This function takes no parameters
0x007F	ROW.HEIGHT
	row-height-params = [val, *3(ref / val)]
0x0080	FORMAT.MOVE
	format-move-params = [val, *2(ref / val)]
0x0081	FORMAT.SIZE
	format-size-params = [val, *2(ref / val)]
0x0082	FORMULA.REPLACE
	formula-replace-params = *11(val)
0x0083	SEND.KEYS
	send-keys-params = *2(val)
0x0084	SELECT.SPECIAL
	select-special-params = *3(val)
0x0085	APPLY.NAMES
	apply-names-params = *7(val)
0x0086	REPLACE.FONT
	replace-font-params = *10(val)
0x0087	FREEZE.PANES
	freeze-panes-params = *3(val)
0x0088	SHOW.INFO
	show-info-params = [val]
0x0089	SPLIT
	split-params = *2(val)
0x008A	ON.WINDOW
	on-window-params = *2(val)
0x008B	ON.DATA
	on-data-params = *2(val)
0x008C	DISABLE.INPUT

Value	Meaning
	disable-input-params = [val]
0x008E	OUTLINE
	outline-params = *4(val)
0x008F	LIST.NAMES
	This function takes no parameters
0x0090	FILE.CLOSE
	file-close-params = *2(val)
0x0091	SAVE.WORKBOOK
	save- workbook -params = *6(val)
0x0092	DATA.FORM
	This function takes no parameters
0x0093	COPY.CHART
	copy-chart-params = [val]
0x0094	ON.TIME
	on-time-params = *4(val)
0x0095	WAIT
	wait-params = [val]
0x0096	FORMAT.FONT
	format-font-params = *15(val)
0x0097	FILL.UP
	This function takes no parameters
0x0098	FILL.LEFT
	This function takes no parameters
0x0099	DELETE.OVERLAY
	This function takes no parameters
0x009B	SHORT.MENUS
	short-menus-params = [val]
0x009F	SET.UPDATE.STATUS
	set-update-status-params = *3(val)
0x00A1	COLOR.PALETTE
	color-palette-params = [val]
0x00A2	DELETE.STYLE

Value	Meaning
	delete-style-params = [val]
0x00A3	WINDOW.RESTORE
	window-restore-params = [val]
0x00A4	WINDOW.MAXIMIZE
	window-maximize-params = [val]
0x00A6	CHANGE.LINK
	change-link-params = *3(val)
0x00A7	CALCULATE.DOCUMENT
	This function takes no parameters
0x00A8	ON.KEY
	on-key-params = *2(val)
0x00A9	APP.RESTORE
	This function takes no parameters
0x00AA	APP.MOVE
	app-move-params = *2(val)
0x00AB	APP.SIZE
	app-size-params = *2(val)
0x00AC	APP.MINIMIZE
	This function takes no parameters
0x00AD	APP.MAXIMIZE
	This function takes no parameters
0x00AE	BRING.TO.FRONT
	This function takes no parameters
0x00AF	SEND.TO.BACK
	This function takes no parameters
0x00B9	MAIN.CHART.TYPE
	main-chart-type-params = [val]
0x00BA	OVERLAY.CHART.TYPE
	overlay-chart-type-params = [val]
0x00BB	SELECT.END
	select-end-params = [val]
0x00BC	OPEN.MAIL

Value	Meaning
	open-mail-params = *2(val)
0x00BD	SEND.MAIL
	send-mail-params = [(ref / val), *2(val)]
0x00BE	STANDARD.FONT
	standard-font-params = *9(val)
0x00BF	CONSOLIDATE
	consolidate-params = *5(val)
0x00C0	SORT.SPECIAL
	sort-special-params = [val, [val, [(ref / val), [(ref / val), [(ref / val), [(ref / val), [(ref / val), [(ref / val), [(ref / val), [(ref / val), *6(val)]]]]]]]]]]]
0x00C1	GALLERY.3D.AREA
	gallery-3d-area-params = [val]
0x00C2	GALLERY.3D.COLUMN
	gallery-3d-column-params = [val]
0x00C3	GALLERY.3D.LINE
	gallery-3d-line-params = [val]
0x00C4	GALLERY.3D.PIE
	gallery-3d-pie-params = [val]
0x00C5	VIEW.3D
	view-3d-params = *6(val)
0x00C6	GOAL.SEEK
	goal-seeK-params = *3(ref / val)
0x00C7	WORKGROUP
	workgroup-params = [val]
0x00C8	FILL.GROUP
	fill-group-params = [val]
0x00C9	UPDATE.LINK
	update-link-params = *2(val)
0x00CA	PROMOTE
	promote-params = [val]
0x00CB	DEMOTE
	demote-params = [val]
0x00CC	SHOW.DETAIL

Value	Meaning
	show-detail-params = *4(val)
0x00CE	UNGROUP
	This function takes no parameters
0x00CF	OBJECT.PROPERTIES
	object-properties-params = *2(val)
0x00D0	SAVE.NEW.OBJECT
	save-new-object-params = [val]
0x00D1	SHARE
	This function takes no parameters
0x00D2	SHARE.NAME
	share-name-params = [val]
0x00D3	DUPLICATE
	This function takes no parameters
0x00D4	APPLY.STYLE
	apply-style-params = [val]
0x00D5	ASSIGN.TO.OBJECT
	assign-to-object-params = [ref / val]
0x00D6	OBJECT.PROTECTION
	object-protection-params = *2(val)
0x00D7	HIDE.OBJECT
	hide-object-params = *2(val)
0x00D8	SET.EXTRACT
	This function takes no parameters
0x00D9	CREATE.PUBLISHER
	create-publisher-params = *4(val)
0x00DA	SUBSCRIBE.TO
	subscribe-to-params = *2(val)
0x00DB	ATTRIBUTES
	attributes-params = *2(val)
0x00DC	SHOW.TOOLBAR
	show-toolbar-params = *10(val)
0x00DE	PRINT.PREVIEW

Value	Meaning
	print-preview-params = [val]
0x00DF	EDIT.COLOR
	edit-color-params = *4(val)
0x00E0	SHOW.LEVELS
	show-levels-params = *2(val)
0x00E1	FORMAT.MAIN
	format-main-params = *14(val)
0x00E2	FORMAT.OVERLAY
	format-overlay-params = *14(val)
0x00E3	ON.RECALC
	on-recalc-params = *2(val)
0x00E4	EDIT.SERIES
	edit-series-params = [val, *6(ref / val)]
0x00E5	DEFINE.STYLE
	define-style-params = *14(val)
0x00F0	LINE.PRINT
	line-print-params = *11(val)
0x00F3	ENTER.DATA
	enter-data-params = [ref / val]
0x00F9	GALLERY.RADAR
	gallery-radar-params = *2(val)
0x00FA	MERGE.STYLES
	merge-styles-params = [val]
0x00FB	EDITION.OPTIONS
	edition-options-params = [val, *6(ref / val)]
0x00FC	PASTE.PICTURE
	This function takes no parameters
0x00FD	PASTE.PICTURE.LINK
	This function takes no parameters
0x00FE	SPELLING
	spelling-params = *6(val)
0x0100	ZOOM

Value	Meaning
	workbook-add-params = *3(val)
0x011A	WORKBOOK.MOVE
	workbook-move-params = *3(val)
0x011B	WORKBOOK.COPY
	workbook-copy-params = *3(val)
0x011C	WORKBOOK.OPTIONS
	workbook-options-params = *3(val)
0x011D	SAVE.WORKSPACE
	save-workspace-params = [val]
0x0120	CHART.WIZARD
	chart-wizard-params = [val, [(ref / val), *12(val)]]
0x0121	DELETE.TOOL
	delete-tool-params = *2(val)
0x0122	MOVE.TOOL
	move-tool-params = *6(val)
0x0123	WORKBOOK.SELECT
	workbook-select-params = *3(val)
0x0124	WORKBOOK.ACTIVATE
	workbook-activate-params = *2(val)
0x0125	ASSIGN.TO.TOOL
	assign-to-tool-params = [val, [val, [ref / val]]]
0x0127	COPY.TOOL
	copy-tool-params = *2(val)
0x0128	RESET.TOOL
	reset-tool-params = *2(val)
0x0129	CONSTRAIN.NUMERIC
	constrain-numeric-params = [val]
0x012A	PASTE.TOOL
	paste-tool-params = *2(val)
0x012E	WORKBOOK.NEW
	workbook-new-params = *3(val)
0x0131	SCENARIO.CELLS

Value	Meaning
	scenario-cells-params = [ref / val]
0x0132	SCENARIO.DELETE
	scenario-delete-params = [val]
0x0133	SCENARIO.ADD
	scenario-add-params = [val, [val, [(ref / val), *3(val)]]]
0x0134	SCENARIO.EDIT
	scenario-edit-params = [val, [val, [val, [(ref / val), *3(val)]]]]
0x0135	SCENARIO.SHOW
	scenario-show-params = [val]
0x0136	SCENARIO.SHOW.NEXT
	This function takes no parameters
0x0137	SCENARIO.SUMMARY
	scenario-summary-params = [(ref / val), [val]]
0x0138	PIVOT.TABLE.WIZARD
	pivot-table-wizard-params = [val, [(ref / val), [(ref / val), *13(val)]]]
0x0139	PIVOT.FIELD.PROPERTIES
	pivot-field-properties-params = *7(val)
0x013A	PIVOT.FIELD
	pivot-field-params = *4(val)
0x013B	PIVOT.ITEM
	pivot-item-params = *4(val)
0x013C	PIVOT.ADD.FIELDS
	pivot-add-fields-params = *5(val)
0x013E	OPTIONS.CALCULATION
	options-calculation-params = *10(val)
0x013F	OPTIONS.EDIT
	options-edit-params = *11(val)
0x0140	OPTIONS.VIEW
	options-view-params = *18(val)
0x0141	ADDIN.MANAGER
	addin-manager-params = *3(val)
0x0142	MENU.EDITOR

Value	Meaning
	This function takes no parameters
0x0143	ATTACH.TOOLBARS
	This function takes no parameters
0x0144	VBAActivate
	vbaactivate-params = *2(val)
0x0145	OPTIONS.CHART
	options-chart-params = *3(val)
0x0148	VBA.INSERT.FILE
	vba-insert-file-params = [val]
0x014A	VBA.PROCEDURE.DEFINITION
	This function takes no parameters
0x0150	ROUTING.SLIP
	routing-slip-params = [(ref / val), *5(val)]
0x0152	ROUTE.DOCUMENT
	This function takes no parameters
0x0153	MAIL.LOGON
	mail-logon-params = [(ref / val), [(ref / val), [val]]]
0x0156	INSERT.PICTURE
	insert-picture-params = *2(val)
0x0157	EDIT.TOOL
	edit-tool-params = *2(val)
0x0158	GALLERY.DOUGHNUT
	gallery-doughnut-params = *2(val)
0x015E	CHART.TREND
	chart-trend-params = *8(val)
0x0160	PIVOT.ITEM.PROPERTIES
	pivot-item-properties-params = *7(val)
0x0162	WORKBOOK.INSERT
	workbook-insert-params = [val]
0x0163	OPTIONS.TRANSITION
	options-transition-params = *5(val)
0x0164	OPTIONS.GENERAL

Value	Meaning
	options-general-params = *14(val)
0x0172	FILTER.ADVANCED
	filter-advanced-params = [val, [(ref / val), [(ref / val), [(ref / val), [val]]]]]
0x0175	MAIL.ADD.MAILER
	This function takes no parameters
0x0176	MAIL.DELETE.MAILER
	This function takes no parameters
0x0177	MAIL.REPLY
	This function takes no parameters
0x0178	MAIL.REPLY.ALL
	This function takes no parameters
0x0179	MAIL.FORWARD
	This function takes no parameters
0x017A	MAIL.NEXT.LETTER
	This function takes no parameters
0x017B	DATA.LABEL
	data-label-params = *10(val)
0x017C	INSERT.TITLE
	insert-title-params = *5(val)
0x017D	FONT.PROPERTIES
	font-properties-params = *14(val)
0x017E	MACRO.OPTIONS
	macro-options-params = *10(val)
0x017F	WORKBOOK.HIDE
	workbook-hide-params = *2(val)
0x0180	WORKBOOK.UNHIDE
	workbook-unhide-params = [val]
0x0181	WORKBOOK.DELETE
	workbook-delete-params = [val]
0x0182	WORKBOOK.NAME
	workbook-name-params = *2(val)
0x0184	GALLERY.CUSTOM

Value	Meaning
	gallery-custom-params = [val]
0x0186	ADD.CHART.AUTOFORMAT
	add-chart-autoformat-params = *2(val)
0x0187	DELETE.CHART.AUTOFORMAT
	delete-chart-autoformat-params = [val]
0x0188	CHART.ADD.DATA
	chart-add-data-params = [val, [(ref / val), *4(val)]]
0x0189	AUTO.OUTLINE
	This function takes no parameters
0x018A	TAB.ORDER
	This function takes no parameters
0x018B	SHOW.DIALOG
	show-dialog-params = [val]
0x018C	SELECT.ALL
	This function takes no parameters
0x018D	UNGROUP.SHEETS
	This function takes no parameters
0x018E	SUBTOTAL.CREATE
	subtotal-create-params = *6(val)
0x018F	SUBTOTAL.REMOVE
	This function takes no parameters
0x0190	RENAME.OBJECT
	rename-object-params = [val]
0x019C	WORKBOOK.SCROLL
	workbook-scroll-params = *2(val)
0x019D	WORKBOOK.NEXT
	This function takes no parameters
0x019E	WORKBOOK.PREV
	This function takes no parameters
0x019F	WORKBOOK.TAB.SPLIT
	workbook-tab-split-params = [val]
0x01A0	FULL.SCREEN

Value	Meaning
	full-screen-params = [val]
0x01A1	WORKBOOK.PROTECT
	workbook-protect-params = *3(val)
0x01A4	SCROLLBAR.PROPERTIES
	scrollbar-properties-params = *7(val)
0x01A5	PIVOT.SHOW.PAGES
	pivot-show-pages-params = *2(val)
0x01A6	TEXT.TO.COLUMNS
	text-to-columns-params = [val, [(ref / val), *12(val)]]
0x01A7	FORMAT.CHARTTYPE
	format-charttype-params = *4(val)
0x01A8	LINK.FORMAT
	This function takes no parameters
0x01A9	TRACER.DISPLAY
	tracer-display-params = *2(val)
0x01AE	TRACER.NAVIGATE
	tracer-navigate-params = *3(val)
0x01AF	TRACER.CLEAR
	This function takes no parameters
0x01B0	TRACER.ERROR
	This function takes no parameters
0x01B1	PIVOT.FIELD.GROUP
	pivot-field-group-params = *4(val)
0x01B2	PIVOT.FIELD.UNGROUP
	This function takes no parameters
0x01B3	CHECKBOX.PROPERTIES
	checkbox-properties-params = *5(val)
0x01B4	LABEL.PROPERTIES
	label-properties-params = *3(val)
0x01B5	LISTBOX.PROPERTIES
	listbox-properties-params = *5(val)
0x01B6	EDITBOX.PROPERTIES

Value	Meaning
	editbox-properties-params = *4(val)
0x01B7	PIVOT.REFRESH
	pivot-refresh-params = [val]
0x01B8	LINK.COMBO
	link-combo-params = [val]
0x01B9	OPEN.TEXT
	open-text-params = *17(val)
0x01BA	HIDE.DIALOG
	hide-dialog-params = [val]
0x01BB	SET.DIALOG.FOCUS
	set-dialog-focus-params = [val]
0x01BC	ENABLE.OBJECT
	enable-object-params = *2(val)
0x01BD	PUSHBUTTON.PROPERTIES
	pushbutton-properties-params = *6(val)
0x01BE	SET.DIALOG.DEFAULT
	set-dialog-default-params = [val]
0x01BF	FILTER
	filter-params = *6(val)
0x01C0	FILTER.SHOW.ALL
	This function takes no parameters
0x01C1	CLEAR.OUTLINE
	This function takes no parameters
0x01C2	FUNCTION.WIZARD
	function-wizard-params = [val]
0x01C3	ADD.LIST.ITEM
	add-list-item-params = *2(val)
0x01C4	SET.LIST.ITEM
	set-list-item-params = *2(val)
0x01C5	REMOVE.LIST.ITEM
	remove-list-item-params = *2(val)
0x01C6	SELECT.LIST.ITEM

Value	Meaning
	select-list-item-params = *2(val)
0x01C7	SET.CONTROL.VALUE
	set-control-value-params = [val]
0x01C8	SAVE.COPY.AS
	save-copy-as-params = [val]
0x01CA	OPTIONS.LISTS.ADD
	options-lists-add-params = [val, [ref / val]]
0x01CB	OPTIONS.LISTS.DELETE
	options-lists-delete-params = [val]
0x01CC	SERIES.AXES
	series-axes-params = [val]
0x01CD	SERIES.X
	series-x-params = [ref / val]
0x01CE	SERIES.Y
	series-y-params = *2(ref / val)
0x01CF	ERRORBAR.X
	errorbar-x-params = [val, [val, [val, [ref / val]]]]
0x01D0	ERRORBAR.Y
	errorbar-y-params = [val, [val, [val, [ref / val]]]]
0x01D1	FORMAT.CHART
	format-chart-params = [(ref / val), *17(val)]
0x01D2	SERIES.ORDER
	series-order-params = *3(val)
0x01D3	MAIL.LOGOFF
	This function takes no parameters
0x01D4	CLEAR.ROUTING.SLIP
	clear-routing-slip-params = [val]
0x01D5	APP.ACTIVATE.MICROSOFT
	app-activate-microsoft-params = [val]
0x01D6	MAIL.EDIT.MAILER
	mail-edit-mailer-params = [val, [(ref / val), [(ref / val), [(ref / val), [val, [ref / val]]]]]]
0x01D7	ON.SHEET

Value	Meaning
	on-sheet-params = *3(val)
0x01D8	STANDARD.WIDTH
	standard-width-params = [val]
0x01D9	SCENARIO.MERGE
	scenario-merge-params = [val]
0x01DA	SUMMARY.INFO
	summary-info-params = *5(val)
0x01DB	FIND.FILE
	This function takes no parameters
0x01DC	ACTIVE.CELL.FONT
	active-cell-font-params = *14(val)
0x01DD	ENABLE.TIPWIZARD
	enable-tipwizard-params = [val]
0x01DE	VBA.MAKE.ADDIN
	vba-make-addin-params = [val]
0x01E0	INSERTDATATABLE
	insertdatatable-params = [val]
0x01E1	WORKGROUP.OPTIONS
	This function takes no parameters
0x01E2	MAIL.SEND.MAILER
	mail-send-mailer-params = *2(val)
0x01E5	AUTOCORRECT
	autocorrect-params = *2(val)
0x01E9	POST.DOCUMENT
	post-document-params = [val]
0x01EB	PICKLIST
	This function takes no parameters
0x01ED	VIEW.SHOW
	view-show-params = [val]
0x01EE	VIEW.DEFINE
	view-define-params = *3(val)
0x01EF	VIEW.DELETE

Value	Meaning
	view-delete-params = [val]
0x01FD	SHEET.BACKGROUND
	sheet-background-params = *2(val)
0x01FE	INSERT.MAP.OBJECT
	This function takes no parameters
0x01FF	OPTIONS.MENONO
	options-menono-params = *5(val)
0x0205	MSOCHECKS
	This function takes no parameters
0x0206	NORMAL
	This function takes no parameters
0x0207	LAYOUT
	This function takes no parameters
0x0208	RM.PRINT.AREA
	rm-print-area-params = [ref / val]
0x0209	CLEAR.PRINT.AREA
	This function takes no parameters
0x020A	ADD.PRINT.AREA
	This function takes no parameters
0x020B	MOVE.BRK
	move-brk-params = *4(val)
0x0221	HIDECURR.NOTE
	hidecurr-note-params = [(ref / val), [val]]
0x0222	HIDEALL.NOTES
	hideall-notes-params = [val]
0x0223	DELETE.NOTE
	delete-note-params = [ref / val]
0x0224	TRAVERSE.NOTES
	traverse-notes-params = [(ref / val), [val]]
0x0225	ACTIVATE.NOTES
	activate-notes-params = [(ref / val), [val]]
0x026C	PROTECT.REVISIONS

Value	Meaning
	This function takes no parameters
0x026D	UNPROTECT.REVISIONS
	This function takes no parameters
0x0287	OPTIONS.ME
	options-me-params = [(ref / val), *8(val)]
0x028D	WEB.PUBLISH
	web-publish-params = *9(val)
0x029B	NEWWEBQUERY
	newwebquery-params = [val]
0x02A1	PIVOT.TABLE.CHART
	pivot-table-chart-params = [val, [(ref / val), [(ref / val), *13(val)]]]
0x02F1	OPTIONS.SAVE
	options-save-params = *4(val)
0x02F3	OPTIONS.SPELL
	options-spell-params = *12(val)
0x0328	HIDEALL.INKANNOTS
	hideall-inkannots-params = [val]

The following grammar is used in the Rgce structure definition:

```

params-cetab = beep-params / open-params / open-links-params / save-as-params /
  file-delete-params / page-setup-params / print-params /
  printer-setup-params /
  arrange-all-params / window-size-params / window-move-params /
  full-params / close-params / run-params /
  set-print-area-params / set-print-titles-params /
  remove-page-break-params / font-params / display-params /
  protect-document-params / precision-params / a1-r1c1-params / calculation-
params / data-find-params /
  extract-params / sort-params / data-series-params /
  table-params / format-number-params / alignment-params /
  style-params / border-params / cell-protection-params /
  column-width-params / cut-params /
  copy-params / paste-params / clear-params /

```

paste-special-params / edit-delete-params / insert-params / define-name-params
/
create-names-params / formula-goto-params / formula-find-params / gallery-area-params /
gallery-bar-params / gallery-column-params / gallery-line-params /
gallery-pie-params / gallery-scatter-params / combination-params / gridlines-params /
set-preferred-params / axes-params / legend-params /
attach-text-params / patterns-params / main-chart-params /
overlay-params / scale-params / format-legend-params /
format-text-params / parse-params / unhide-params /
workspace-params / formula-params / formula-fill-params /
formula-array-params / activate-params /
activate-next-params / activate-prev-params / copy-picture-params / select-params /
delete-name-params / delete-format-params / vline-params /
hline-params / vpage-params / hpage-params /
vscroll-params / hscroll-params / alert-params /
new-params / cancel-copy-params /
message-params / app-activate-params / row-height-params / format-move-params /
format-size-params / formula-replace-params / send-keys-params /
select-special-params / apply-names-params / replace-font-params /
freeze-panes-params / show-info-params / split-params /
on-window-params / on-data-params / disable-input-params /
outline-params / file-close-params /
save-workbook-params / copy-chart-params /
on-time-params / wait-params / format-font-params /
short-menus-params / set-update-status-params / color-palette-params /
delete-style-params / window-restore-params / window-maximize-params /
change-link-params / on-key-params / app-move-params / app-size-params / main-chart-type-params / overlay-chart-type-params /
select-end-params / open-mail-params / send-mail-params /
standard-font-params / consolidate-params / sort-special-params /
gallery-3d-area-params / gallery-3d-column-params / gallery-3d-line-params /
gallery-3d-pie-params / view-3d-params / goal-seek-params /
workgroup-params / fill-group-params / update-link-params /

promote-params / demote-params / show-detail-params / object-properties-params
/ save-new-object-params / share-name-params /
apply-style-params / assign-to-object-params / object-protection-params /
hide-object-params / create-publisher-params /
subscribe-to-params / attributes-params / show-toolbar-params /
print-preview-params / edit-color-params / show-levels-params /
format-main-params / format-overlay-params / on-recalc-params /
edit-series-params / define-style-params / line-print-params /
enter-data-params / gallery-radar-params / merge-styles-params /
edition-options-params /
spelling-params / zoom-params / insert-object-params /
window-minimize-params /
sound-note-params / sound-play-params / format-shape-params /
extend-polygon-params / format-auto-params / gallery-3d-bar-params /
gallery-3d-surface-params / fill-auto-params / customize-toolbar-params /
add-tool-params / edit-object-params / on-doubeclck-params /
on-entry-params / workbook-add-params / workbook-move-params /
workbook-copy-params / workbook-options-params / save-workspace-params /
chart-wizard-params / delete-tool-params / move-tool-params /
workbook-select-params / workbook-activate-params / assign-to-tool-params /
copy-tool-params / reset-tool-params / constrain-numeric-params /
paste-tool-params / placement-params /
workbook-new-params / scenario-cells-params / scenario-delete-params /
scenario-add-params / scenario-edit-params / scenario-show-params / scenario-
summary-params / pivot-table-wizard-params /
pivot-field-properties-params / pivot-field-params / pivot-item-params /
pivot-add-fields-params / options-calculation-params / options-edit-params /
options-view-params / addin-manager-params / vbaactivate-params / options-
chart-params /
vba-insert-file-params / routing-slip-params / mail-logon-params / insert-
picture-params /
edit-tool-params / gallery-doughnut-params / chart-trend-params /
pivot-item-properties-params / workbook-insert-params / options-transition-
params /
options-general-params / filter-advanced-params / data-label-params /
insert-title-params / font-properties-params / macro-options-params /

workbook-hide-params / workbook-unhide-params / workbook-delete-params /
workbook-name-params / gallery-custom-params / add-chart-autoformat-params /
delete-chart-autoformat-params / chart-add-data-params / show-dialog-params /
subtotal-create-params /
rename-object-params / workbook-scroll-params / workbook-tab-split-params /
full-screen-params /
workbook-protect-params / scrollbar-properties-params / pivot-show-pages-params
/
text-to-columns-params / format-charttype-params /
tracer-display-params / tracer-navigate-params / pivot-field-group-params /
checkbox-properties-params / label-properties-params / listbox-properties-
params /
editbox-properties-params / pivot-refresh-params / link-combo-params /
open-text-params / hide-dialog-params / set-dialog-focus-params /
enable-object-params / pushbutton-properties-params / set-dialog-default-params
/
filter-params /
function-wizard-params / add-list-item-params / set-list-item-params /
remove-list-item-params / select-list-item-params / set-control-value-params /
save-copy-as-params / options-lists-add-params / options-lists-delete-params /
series-axes-params / series-x-params / series-y-params /
errorbar-x-params / errorbar-y-params / format-chart-params /
series-order-params / clear-routing-slip-params /
app-activate-microsoft-params / mail-edit-mailer-params / on-sheet-params /
standard-width-params / scenario-merge-params / summary-info-params / active-
cell-font-params / enable-tipwizard-params /
vba-make-addin-params / insertdatatable-params /
mail-send-mailer-params / autocorrect-params / post-document-params / view-
show-params / view-define-params /
view-delete-params / sheet-background-params /
options-menono-params / rm-print-area-params / move-brk-params / hidecurr-note-
params /
hideall-notes-params / delete-note-params / traverse-notes-params /
activate-notes-params /
options-me-params / web-publish-params / newwebquery-params /
pivot-table-chart-params / options-save-params / options-spell-params /
hideall-inkannots-params

2.5.198.5 CFParsedFormula

The **CFParsedFormula** structure specifies a formula (section 2.2.2) used in a **conditional formatting** rule.

0	1	2	3	4	5	6	7	8	9	10	1	2	3	4	5	6	7	8	9	20	1	2	3	4	5	6	7	8	9	30	1		
cce																rgce (variable)																	
...																																	

cce (2 bytes): An unsigned integer that specifies the length of **rgce** in bytes.

rgce (variable): An [Rgce](#) that specifies the sequence of Ptg structures for the formula. MUST NOT contain [PtgExp](#), [PtgTbl](#), [PtgElfLel](#), [PtgElfRw](#), [PtgElfCol](#), [PtgElfRwV](#), [PtgElfColV](#), [PtgElfRadical](#), [PtgElfRadicalS](#), [PtgElfColS](#), [PtgElfColSV](#), [PtgElfRadicalLel](#), [PtgSxName](#), [PtgIsect](#), [PtgUnion](#), [PtgArray](#), [PtgRef3d](#), [PtgArea3d](#), [PtgRefErr3d](#), [PtgAreaErr3d](#), [PtgNameX](#), [PtgMemArea](#), or [PtgMemNoMem](#). A [PtgArea](#) or a [PtgAreaN](#) MUST NOT be the only Ptg structure in the sequence.

The root node of the parse tree of this field MUST be a VALUE_TYPE, as described in Rgce.

2.5.198.6 CFParsedFormulaNoCCE

The **CFParsedFormulaNoCCE** structure specifies a formula (section 2.2.2) used in a **conditional formatting** rule, in a [CF](#) or [CF12](#) record in which the size of the formula in bytes is specified.

0	1	2	3	4	5	6	7	8	9	10	1	2	3	4	5	6	7	8	9	20	1	2	3	4	5	6	7	8	9	30	1		
rgce (variable)																																	
...																																	

rgce (variable): An [Rgce](#) that specifies the sequence of Ptgs for the formula. MUST NOT contain [PtgExp](#), [PtgTbl](#), [PtgElfLel](#), [PtgElfRw](#), [PtgElfCol](#), [PtgElfRwV](#), [PtgElfColV](#), [PtgElfRadical](#), [PtgElfRadicalS](#), [PtgElfColS](#), [PtgElfColSV](#), [PtgElfRadicalLel](#), [PtgSxName](#), [PtgIsect](#), [PtgUnion](#), [PtgArray](#), [PtgRef3d](#), [PtgArea3d](#), [PtgRefErr3d](#), [PtgAreaErr3d](#), [PtgNameX](#), [PtgMemArea](#), or [PtgMemNoMem](#). A [PtgArea](#) or a [PtgAreaN](#) MUST NOT be the only Ptg in the sequence.

The root node of the parse tree of this field MUST be a VALUE_TYPE, as described in Rgce.

2.5.198.7 CFVOParsedFormula

The **CFVOParsedFormula** structure specifies a formula (section 2.2.2) without **relative references** that is used in a **conditional formatting** rule.

0	1	2	3	4	5	6	7	8	9	10	1	2	3	4	5	6	7	8	9	20	1	2	3	4	5	6	7	8	9	30	1		
cce																rgce (variable)																	
...																																	

cce (2 bytes): An unsigned integer that specifies the length of **rgce** in bytes. MUST be greater than 0.

rgce (variable): An [Rgce](#) that specifies the sequence of Ptgs for the formula. MUST NOT contain [PtgExp](#), [PtgTbl](#), [PtgElfLel](#), [PtgElfRw](#), [PtgElfCol](#), [PtgElfRwV](#), [PtgElfColV](#), [PtgElfRadical](#), [PtgElfRadicalS](#), [PtgElfColS](#), [PtgElfColSV](#), [PtgElfRadicalLel](#), [PtgSxName](#), [PtgIsect](#), [PtgUnion](#), [PtgArray](#), [PtgRef3d](#), [PtgArea3d](#), [PtgRefErr3d](#), [PtgAreaErr3d](#), [PtgNameX](#), [PtgMemArea](#), or [PtgMemNoMem](#). A [PtgArea](#) or a [PtgAreaN](#) MUST NOT be the only Ptg in the sequence.

If this field contains a [PtgRef](#), then the **loc.column.colRelative** and **loc.column.rowRelative** fields in the PtgRef MUST be 0.

If this field contains a [PtgRefN](#), then the **loc.column.colRelative** and **loc.column.rowRelative** fields in the PtgRefN MUST be 0.

If this field contains a PtgArea, then the **area.columnFirst.colRelative**, **area.columnFirst.rowRelative**, **area.columnLast.colRelative**, and **area.columnLast.rowRelative** fields in the PtgArea MUST be 0.

If this field contains a PtgAreaN, then the **area.columnFirst.colRelative**, **area.columnFirst.rowRelative**, **area.columnLast.colRelative**, and **area.columnLast.rowRelative** fields in the PtgAreaN MUST be 0.

The root node of the parse tree of this field MUST be a VALUE_TYPE, as described in Rgce.

2.5.198.8 ChartParsedFormula

The **ChartParsedFormula** structure specifies a formula (section [2.2.2](#)) used in a chart.

0	1	2	3	4	5	6	7	8	9	10	1	2	3	4	5	6	7	8	9	20	1	2	3	4	5	6	7	8	9	30	1		
cce											rgce (variable)																						
...																																	

cce (2 bytes): An unsigned integer that specifies the length of **rgce** in bytes.

rgce (variable): An [Rgce](#) that specifies the sequence of Ptgs for the formula. MUST contain only the following Ptgs: [PtgParen](#), [PtgUnion](#), [PtgRef3d](#), [PtgRefErr3d](#), [PtgArea3d](#), [PtgAreaErr3d](#), [PtgNameX](#), or [PtgMemFunc](#).

2.5.198.9 DVParsedFormula

The **DVParsedFormula** structure specifies a formula (section [2.2.2](#)) used in a **data validation** rule.

0	1	2	3	4	5	6	7	8	9	10	1	2	3	4	5	6	7	8	9	20	1	2	3	4	5	6	7	8	9	30	1		
cce											unused																						
rgce (variable)																																	
...																																	

cce (2 bytes): An unsigned integer that specifies the length of **rgce** in bytes.

unused (2 bytes): Undefined and MUST be ignored.

rgce (variable): An [Rgce](#) that specifies the sequence of Ptg for the formula. MUST NOT contain [PtgExp](#), [PtgTbl](#), [PtgElfLel](#), [PtgElfRw](#), [PtgElfCol](#), [PtgElfRwV](#), [PtgElfColV](#), [PtgElfRadical](#), [PtgElfRadicalS](#), [PtgElfColS](#), [PtgElfColSV](#), [PtgElfRadicalLel](#), [PtgSxName](#), [PtgIsect](#), [PtgUnion](#), [PtgArray](#), [PtgRef3d](#), [PtgRefErr3d](#), [PtgNameX](#), [PtgMemArea](#), or [PtgMemNoMem](#).

If the [Dv](#) record that contains this **DVParsedFormula** in its **Dv.formula1** field has a **Dv.valType** not equal to 3, then the following MUST be true:

- **rgce** MUST NOT contain a [PtgArea3d](#) or a [PtgAreaErr3d](#).
- A [PtgArea](#), a [PtgAreaErr](#), or a [PtgAreaN](#), MUST NOT be the only Ptg in **rgce**.
- The root node of the parse tree of this field MUST be a VALUE_TYPE, as described in [Rgce](#).

If the [Dv](#) record that contains this **DVParsedFormula** in its **Dv.formula1** field has a **Dv.valType** equal to 3, then the following MUST be true:

- If **rgce** contains a [PtgArea3d](#) or a [PtgAreaErr3d](#) then the [PtgArea3d](#) or [PtgAreaErr3d](#) MUST be the only Ptg in **rgce**.
- The root node of the parse tree of this field MUST NOT be a VALUE_TYPE, as described in [Rgce](#).

If this **DVParsedFormula** is in **Dv.formula2** field, then the following MUST be true:

- **rgce** MUST NOT contain a [PtgArea3d](#) or a [PtgAreaErr3d](#).
- A [PtgArea](#), a [PtgAreaErr](#), or a [PtgAreaN](#), MUST NOT be the only Ptg in **rgce**.
- The root node of the parse tree of this field MUST be a VALUE_TYPE, as described in [Rgce](#).

2.5.198.10 ExtNameParsedFormula

The **ExtNameParsedFormula** structure specifies a formula (section [2.2.2](#)) used in an [external defined name](#).

0	1	2	3	4	5	6	7	8	9	10	11	12	13	14	15	16	17	18	19	20	21	22	23	24	25	26	27	28	29	30	31
cb															extPtg (optional)							val (variable)									
...																															

cb (2 bytes): An unsigned integer that specifies the number of bytes in **extPtg** + the number of bytes in **val**. If the **defined name** that this external defined name specifies does not exist in its containing **workbook**, this value MUST be 0, and **extPtg** and **val** MUST NOT exist.

extPtg (1 byte): An unsigned integer that specifies the formula type of **val**. This field MUST exist if and only if **cb** is greater than 0. MUST be one of the values as specified in the table in the **val** field section.

val (variable): An optional field that specifies the formula of an external defined name. If the formula cannot be represented correctly with one formula types allowed in this field, then this field MUST specify an [ExtPtgErr](#) formula. This field MUST exist if and only if **cb** is greater than 0. The size and the type of the formula vary based on the value of **extPtg** as follows:

extPtg value	Val field Data and Meaning
0x3A	Specifies an ExtPtgRef3D formula.

extPtg value	Val field Data and Meaning
0x3B	Specifies an ExtPtgArea3D formula.
0x3C	Specifies an ExtPtgRefErr3D formula.
0x3D	Specifies an ExtPtgAreaErr3D formula.
0x1C	Specifies an ExtPtgErr formula.

2.5.198.11 ExtPtgArea3D

The **ExtPtgArea3D** structure is a variation of [PtgArea3d](#) that is used by formulas in an [external defined name](#). It specifies a rectangular **cell** range on one or more **sheet**.

0	1	2	3	4	5	6	7	8	9	10	1	2	3	4	5	6	7	8	9	20	1	2	3	4	5	6	7	8	9	30	1
iTabs																															
area																															
...																															

iTabs (4 bytes): An [ExtSheetPair](#) that specifies the sheet or sheets containing the range.

area (8 bytes): A [RgceAreaRel](#) that specifies the location of the range of cells within a sheet.

2.5.198.12 ExtPtgAreaErr3D

The **ExtPtgAreaErr3D** structure is a variation of [PtgAreaErr3d](#) that is used by formulas in an [external defined name](#). It specifies an invalid reference to a regular range of cells on one or more **sheets**.

0	1	2	3	4	5	6	7	8	9	10	1	2	3	4	5	6	7	8	9	20	1	2	3	4	5	6	7	8	9	30	1
iTabs																															
unused1																															
unused2																															

iTabs (4 bytes): An [ExtSheetPair](#) that specifies the sheet or sheets containing the target of this reference.

unused1 (4 bytes): Undefined and MUST be ignored.

unused2 (4 bytes): Undefined and MUST be ignored.

2.5.198.13 ExtPtgErr

The **ExtPtgErr** structure is a variation of [PtgErr](#) that is used by formulas in an external defined name. It specifies an invalid **cell** reference.

0	1	2	3	4	5	6	7	8	9	1	0	1	2	3	4	5	6	7	8	9	2	0	1	2	3	4	5	6	7	8	9	3	0	1
err																																		

err (1 byte): A [BErr](#) that specifies the value of this error. The value MUST be 0x17.

2.5.198.14 ExtPtgRef3D

The **ExtPtgRef3D** structure is a variation of [PtgRef3d](#) that is used by formulas in an [external defined name](#). It specifies the location of a single **cell** on one or more **sheets**.

0	1	2	3	4	5	6	7	8	9	1	0	1	2	3	4	5	6	7	8	9	2	0	1	2	3	4	5	6	7	8	9	3	0	1
iTabs																																		
loc																																		

iTabs (4 bytes): An [ExtSheetPair](#) that specifies the sheet or sheets containing the cell.

loc (4 bytes): A [RqceLocRel](#) that specifies the location of a cell within a sheet.

2.5.198.15 ExtPtgRefErr3D

The **ExtPtgRefErr3D** structure is a variation of [PtgRefErr3d](#) that is used by formulas in an [external defined name](#). It specifies an invalid single **cell** reference on one or more **sheets**.

0	1	2	3	4	5	6	7	8	9	1	0	1	2	3	4	5	6	7	8	9	2	0	1	2	3	4	5	6	7	8	9	3	0	1
iTabs																																		
unused																																		

iTabs (4 bytes): An [ExtSheetPair](#) that specifies the sheet or sheets containing the target of this reference.

unused (4 bytes): Undefined and MUST be ignored.

2.5.198.16 ExtSheetPair

The **ExtSheetPair** structure specifies a pair of **sheets** in the formulas of an [external defined name](#). The sheets are in the [External Workbook](#) as specified by the preceding [SupBook](#) record.

0	1	2	3	4	5	6	7	8	9	1	0	1	2	3	4	5	6	7	8	9	2	0	1	2	3	4	5	6	7	8	9	3	0	1
itabFirst										itabLast																								

itabFirst (2 bytes): A signed integer that specifies the first sheet of a single or multi-sheet reference. It MUST be a value from the following table:

Value	Meaning
-1	Specifies that the first sheet of this reference could not be found.
>=0	This value specifies the zero-based index of an XLUnicodeString in the rgst field of the preceding SupBook record. The XLUnicodeString specifies the name of the first referenced sheet within the supporting workbook. This value MUST be less than the value of the ctab field in the preceding SupBook record.

itabLast (2 bytes): A signed integer that specifies the last sheet of a single or multi-sheet reference. The value MUST be greater than or equal to **itabFirst** if it is not -1 and MUST be a value from the following table:

Value	Meaning
-1	Specifies that the last sheet of this reference could not be found.
>=0	This value specifies the zero-based index of an XLUnicodeString in the rgst field of the preceding SupBook record. The XLUnicodeString specifies the name of the last referenced sheet within the supporting workbook. This value MUST be less than the value of the ctab field in the preceding SupBook record.

2.5.198.17 Ftab

The **Ftab** structure specifies a function which can be called from a formula (section [2.2.2](#)). The definition of each function specifies the function name and the valid sequence of arguments.

0	1	2	3	4	5	6	7	8	9	10	11	12	13	14	15	16	17	18	19	20	21	22	23	24	25	26	27	28	29	30	31
iftab																															

iftab (2 bytes): An unsigned integer that specifies the function to be called. MUST be a value from the following table:

The elements [ref](#) and val are specified in Rgce.

Value	Meaning
0x0000	COUNT
	count-params = (ref / val), *29(ref / val)
0x0001	IF
	if-params = val, *2(ref / val)
0x0002	ISNA
	isna-params = val
0x0003	ISERROR
	iserror-params = val
0x0004	SUM
	sum-params = (ref / val), *29(ref / val)

Value	Meaning
0x0005	AVERAGE
	average-params = (ref / val), *29(ref / val)
0x0006	MIN
	min-params = (ref / val), *29(ref / val)
0x0007	MAX
	max-params = (ref / val), *29(ref / val)
0x0008	ROW
	row-params = [ref]
0x0009	COLUMN
	column-params = [ref]
0x000A	NA
	This function takes no parameters
0x000B	NPV
	npv-params = val, (ref / val), *28(ref / val)
0x000C	STDEV
	stdev-params = (ref / val), *29(ref / val)
0x000D	DOLLAR
	dollar-params = val, [val]
0x000E	FIXED
	fixed-params = val, [val, [val]]
0x000F	SIN
	sin-params = val
0x0010	COS
	cos-params = val
0x0011	TAN
	tan-params = val
0x0012	ATAN
	atan-params = val
0x0013	PI
	This function takes no parameters
0x0014	SQRT
	sqrt-params = val

Value	Meaning
0x0015	EXP
	exp-params = val
0x0016	LN
	ln-params = val
0x0017	LOG10
	log10-params = val
0x0018	ABS
	abs-params = val
0x0019	INT
	int-params = val
0x001A	SIGN
	sign-params = val
0x001B	ROUND
	round-params = val, val
0x001C	LOOKUP
	lookup-params = val, (ref / val), [ref / val]
0x001D	INDEX
	index-params = (ref / val), val, *2(val)
0x001E	REPT
	rept-params = val, val
0x001F	MID
	mid-params = val, val, val
0x0020	LEN
	len-params = val
0x0021	VALUE
	value-params = val
0x0022	TRUE
	This function takes no parameters
0x0023	FALSE
	This function takes no parameters
0x0024	AND
	and-params = (ref / val), *29(ref / val)

Value	Meaning
0x0025	OR
	or-params = (ref / val), *29(ref / val)
0x0026	NOT
	not-params = val
0x0027	MOD
	mod-params = val, val
0x0028	DCOUNT
	dcount-params = ref, (ref / val), (ref / val)
0x0029	DSUM
	dsum-params = ref, (ref / val), (ref / val)
0x002A	DAVERAGE
	daverage-params = ref, (ref / val), (ref / val)
0x002B	DMIN
	dmin-params = ref, (ref / val), (ref / val)
0x002C	DMAX
	dmax-params = ref, (ref / val), (ref / val)
0x002D	DSTDEV
	dstdev-params = ref, (ref / val), (ref / val)
0x002E	VAR
	var-params = (ref / val), *29(ref / val)
0x002F	DVAR
	dvar-params = ref, (ref / val), (ref / val)
0x0030	TEXT
	text-params = val, val
0x0031	LINEST
	linest-params = (ref / val), [(ref / val), *2(ref / val)]
0x0032	TREND
	trend-params = (ref / val), [(ref / val), [(ref / val), [ref / val]]]
0x0033	LOGEST
	logest-params = (ref / val), [(ref / val), *2(ref / val)]
0x0034	GROWTH
	growth-params = (ref / val), [(ref / val), [(ref / val), [ref / val]]]

Value	Meaning
0x0035	GOTO
	goto-params = ref
0x0036	HALT
	halt-params = [val]
0x0037	RETURN
	return-params = [ref / val]
0x0038	PV
	pv-params = val, val, val, *2(val)
0x0039	FV
	fv-params = val, val, val, *2(val)
0x003A	NPER
	nper-params = val, val, val, *2(val)
0x003B	PMT
	pmt-params = val, val, val, *2(val)
0x003C	RATE
	rate-params = val, val, val, *3(val)
0x003D	MIRR
	mirr-params = (ref / val), val, val
0x003E	IRR
	irr-params = (ref / val), [val]
0x003F	RAND
	This function takes no parameters
0x0040	MATCH
	match-params = val, (ref / val), [ref / val]
0x0041	DATE
	date-params = val, val, val
0x0042	TIME
	time-params = val, val, val
0x0043	DAY
	day-params = val
0x0044	MONTH
	month-params = val

Value	Meaning
0x0045	YEAR
	year-params = val
0x0046	WEEKDAY
	weekday-params = val, [val]
0x0047	HOUR
	hour-params = val
0x0048	MINUTE
	minute-params = val
0x0049	SECOND
	second-params = val
0x004A	NOW
	This function takes no parameters
0x004B	AREAS
	areas-params = ref
0x004C	ROWS
	rows-params = (ref / val)
0x004D	COLUMNS
	columns-params = (ref / val)
0x004E	OFFSET
	offset-params = ref, val, val, *2(val)
0x004F	ABSREF
	absref-params = val, ref
0x0050	RELREF
	relref-params = ref, ref
0x0051	ARGUMENT
	argument-params = [val, [(ref / val), [ref]]]
0x0052	SEARCH
	search-params = val, val, [val]
0x0053	TRANSPOSE
	transpose-params = val
0x0054	ERROR
	error-params = [val, [ref / val]]

Value	Meaning
0x0055	STEP
	This function takes no parameters
0x0056	TYPE
	type-params = val
0x0057	ECHO
	echo-params = [val]
0x0058	SET.NAME
	set-name-params = val, [ref / val]
0x0059	CALLER
	This function takes no parameters
0x005A	DEREF
	deref-params = ref
0x005B	WINDOWS
	windows-params = [val, [val]]
0x005C	SERIES
	series-params = (ref / val), (ref / val), (ref / val), val, [ref / val]
0x005D	DOCUMENTS
	documents-params = [val, [val]]
0x005E	ACTIVE.CELL
	This function takes no parameters
0x005F	SELECTION
	This function takes no parameters
0x0060	RESULT
	result-params = [val]
0x0061	ATAN2
	atan2-params = val, val
0x0062	ASIN
	asin-params = val
0x0063	ACOS
	acos-params = val
0x0064	CHOOSE
	choose-params = val, (ref / val), *28(ref / val)

Value	Meaning
0x0065	HLOOKUP
	hlookup-params = val, (ref / val), (ref / val), [val]
0x0066	VLOOKUP
	vlookup-params = val, (ref / val), (ref / val), [val]
0x0067	LINKS
	links-params = [val, [val]]
0x0068	INPUT
	input-params = val, [val, [val, [val, [val, [val, [val]]]]]]
0x0069	ISREF
	isref-params = (ref / val)
0x006A	GET.FORMULA
	get-formula-params = (ref / val)
0x006B	GET.NAME
	get-name-params = val, [val]
0x006C	SET.VALUE
	set-value-params = ref, val
0x006D	LOG
	log-params = val, [val]
0x006E	EXEC
	exec-params = val, [val, *2(val)]
0x006F	CHAR
	char-params = val
0x0070	LOWER
	lower-params = val
0x0071	UPPER
	upper-params = val
0x0072	PROPER
	proper-params = val
0x0073	LEFT
	left-params = val, [val]
0x0074	RIGHT
	right-params = val, [val]

Value	Meaning
0x0075	EXACT
	exact-params = val, val
0x0076	TRIM
	trim-params = val
0x0077	REPLACE
	replace-params = val, val, val, val
0x0078	SUBSTITUTE
	substitute-params = val, val, val, [val]
0x0079	CODE
	code-params = val
0x007A	NAMES
	names-params = [val, [val, [val]]]
0x007B	DIRECTORY
	directory-params = [val]
0x007C	FIND
	find-params = val, val, [val]
0x007D	CELL
	cell-params = val, [ref]
0x007E	ISERR
	iserr-params = val
0x007F	ISTEXT
	istext-params = val
0x0080	ISNUMBER
	isnumber-params = val
0x0081	ISBLANK
	isblank-params = val
0x0082	T
	t-params = (ref / val)
0x0083	N
	n-params = (ref / val)
0x0084	FOPEN
	fopen-params = val, [val]

Value	Meaning
0x0085	FCLOSE
	fclose-params = val
0x0086	FSIZE
	fsize-params = val
0x0087	FREADLN
	freadln-params = val
0x0088	FREAD
	fread-params = val, val
0x0089	FWRITELN
	fwriteln-params = val, val
0x008A	FWRITE
	fwrite-params = val, val
0x008B	FPOS
	fpos-params = val, [val]
0x008C	DATEVALUE
	datevalue-params = val
0x008D	TIMEVALUE
	timevalue-params = val
0x008E	SLN
	sln-params = val, val, val
0x008F	SYD
	syd-params = val, val, val, val
0x0090	DDB
	ddb-params = val, val, val, val, [val]
0x0091	GET.DEF
	get-def-params = val, [val, [val]]
0x0092	REFTEXT
	reftext-params = ref, [val]
0x0093	TEXTREF
	textref-params = val, [val]
0x0094	INDIRECT
	indirect-params = val, [val]

Value	Meaning
0x00A5	MMULT
	mmult-params = val, val
0x00A6	FILES
	files-params = *2(val)
0x00A7	IPMT
	ipmt-params = val, val, val, val, *2(val)
0x00A8	PPMT
	ppmt-params = val, val, val, val, *2(val)
0x00A9	COUNTA
	counta-params = (ref / val), *29(ref / val)
0x00AA	CANCEL.KEY
	cancel-key-params = [val, [ref]]
0x00AB	FOR
	for-params = val, val, val, [val]
0x00AC	WHILE
	while-params = val
0x00AD	BREAK
	This function takes no parameters
0x00AE	NEXT
	This function takes no parameters
0x00AF	INITIATE
	initiate-params = val, val
0x00B0	REQUEST
	request-params = val, val
0x00B1	POKE
	poke-params = val, (ref / val), (ref / val)
0x00B2	EXECUTE
	execute-params = val, val
0x00B3	TERMINATE
	terminate-params = val
0x00B4	RESTART
	restart-params = [val]

Value	Meaning
0x00B5	HELP
	help-params = [val]
0x00B6	GET.BAR
	get-bar-params = *4(val)
0x00B7	PRODUCT
	product-params = (ref / val), *29(ref / val)
0x00B8	FACT
	fact-params = val
0x00B9	GET.CELL
	get-cell-params = val, [ref]
0x00BA	GET.WORKSPACE
	get-workspace-params = val
0x00BB	GET.WINDOW
	get-window-params = val, [val]
0x00BC	GET.DOCUMENT
	get-document-params = val, [val]
0x00BD	DPRODUCT
	dproduct-params = ref, (ref / val), (ref / val)
0x00BE	ISNONTEXT
	isnontext-params = val
0x00BF	GET.NOTE
	get-note-params = [(ref / val), *2(val)]
0x00C0	NOTE
	note-params = [val, [(ref / val), *2(ref / val)]]
0x00C1	STDEVP
	stdevp-params = (ref / val), *29(ref / val)
0x00C2	VARP
	varp-params = (ref / val), *29(ref / val)
0x00C3	DSTDEVP
	dstdevp-params = ref, (ref / val), (ref / val)
0x00C4	DVARP
	dvarp-params = ref, (ref / val), (ref / val)

Value	Meaning
0x00C5	TRUNC
	trunc-params = val, [val]
0x00C6	ISLOGICAL
	islogical-params = val
0x00C7	DCOUNTA
	dcounta-params = ref, (ref / val), (ref / val)
0x00C8	DELETE.BAR
	delete-bar-params = val
0x00C9	UNREGISTER
	unregister-params = val
0x00CC	USDOLLAR
	usdollar-params = val, [val]
0x00CD	FINDB
	findb-params = val, val, [val]
0x00CE	SEARCHB
	searchb-params = val, val, [val]
0x00CF	REPLACEB
	replaceb-params = val, val, val, val
0x00D0	LEFTB
	leftb-params = val, [val]
0x00D1	RIGHTB
	rightb-params = val, [val]
0x00D2	MIDB
	midb-params = val, val, val
0x00D3	LENB
	lenb-params = val
0x00D4	ROUNDUP
	roundup-params = val, val
0x00D5	ROUNDDOWN
	rounddown-params = val, val
0x00D6	ASC
	asc-params = val

Value	Meaning
0x00D7	DBCS
	dbcs-params = val
0x00D8	RANK
	rank-params = val, ref, [val]
0x00DB	ADDRESS
	address-params = val, val, [val, [val, [val]]]
0x00DC	DAYS360
	days360-params = val, val, [val]
0x00DD	TODAY
	This function takes no parameters
0x00DE	VDB
	vdb-params = val, val, val, val, val, [val, [val]]
0x00DF	ELSE
	This function takes no parameters
0x00E0	ELSE.IF
	else-if-params = val
0x00E1	END.IF
	This function takes no parameters
0x00E2	FOR.CELL
	for-cell-params = val, [(ref / val), [ref / val]]
0x00E3	MEDIAN
	median-params = (ref / val), *29(ref / val)
0x00E4	SUMPRODUCT
	sumproduct-params = val, *29(val)
0x00E5	SINH
	sinh-params = val
0x00E6	COSH
	cosh-params = val
0x00E7	TANH
	tanh-params = val
0x00E8	ASINH
	asinh-params = val

Value	Meaning
0x00FB	RESUME
	resume-params = [val]
0x00FC	FREQUENCY
	frequency-params = (ref / val), (ref / val)
0x00FD	ADD.TOOLBAR
	add-toolbar-params = [val, [val]]
0x00FE	DELETE.TOOLBAR
	delete-toolbar-params = val
0x00FF	User Defined Function
	user-defined-function-params = (ref / val), [(ref / val), *28(ref / val)]
0x0100	RESET.TOOLBAR
	reset-toolbar-params = val
0x0101	EVALUATE
	evaluate-params = val
0x0102	GET.TOOLBAR
	get-toolbar-params = val, [val]
0x0103	GET.TOOL
	get-tool-params = val, [val, [val]]
0x0104	SPELLING.CHECK
	spelling-check-params = val, [val, [val]]
0x0105	ERROR.TYPE
	error-type-params = val
0x0106	APP.TITLE
	app-title-params = [val]
0x0107	WINDOW.TITLE
	window-title-params = [val]
0x0108	SAVE.TOOLBAR
	save-toolbar-params = [val, [val]]
0x0109	ENABLE.TOOL
	enable-tool-params = val, val, val
0x010A	PRESS.TOOL
	press-tool-params = val, val, val

Value	Meaning
0x010B	REGISTER.ID
	register-id-params = val, val, [val]
0x010C	GET.WORKBOOK
	get-workbook-params = val, [val]
0x010D	AVEDEV
	avedev-params = (ref / val), *29(ref / val)
0x010E	BETADIST
	betadist-params = val, val, val, *2(val)
0x010F	GAMMALN
	gammaln-params = val
0x0110	BETAINV
	betainv-params = val, val, val, *2(val)
0x0111	BINOMDIST
	binomdist-params = val, val, val, val
0x0112	CHIDIST
	chidist-params = val, val
0x0113	CHIINV
	chiinv-params = val, val
0x0114	COMBIN
	combin-params = val, val
0x0115	CONFIDENCE
	confidence-params = val, val, val
0x0116	CRITBINOM
	critbinom-params = val, val, val
0x0117	EVEN
	even-params = val
0x0118	EXPONDIST
	expondist-params = val, val, val
0x0119	FDIST
	fdist-params = val, val, val
0x011A	FINV
	finv-params = val, val, val

Value	Meaning
0x011B	FISHER
	fisher-params = val
0x011C	FISHERINV
	fisherinv-params = val
0x011D	FLOOR
	floor-params = val, val
0x011E	GAMMADIST
	gammadist-params = val, val, val, val
0x011F	GAMMAINV
	gammainv-params = val, val, val
0x0120	CEILING
	ceiling-params = val, val
0x0121	HYPGEOMDIST
	hypgeomdist-params = val, val, val, val
0x0122	LOGNORMDIST
	lognormdist-params = val, val, val
0x0123	LOGINV
	loginv-params = val, val, val
0x0124	NEGBINOMDIST
	negbinomdist-params = val, val, val
0x0125	NORMDIST
	normdist-params = val, val, val, val
0x0126	NORMSDIST
	normsdist-params = val
0x0127	NORMINV
	norminv-params = val, val, val
0x0128	NORMSINV
	normsinv-params = val
0x0129	STANDARDIZE
	standardize-params = val, val, val
0x012A	ODD
	odd-params = val

Value	Meaning
0x012B	PERMUT
	permut-params = val, val
0x012C	POISSON
	poisson-params = val, val, val
0x012D	TDIST
	tdist-params = val, val, val
0x012E	WEIBULL
	weibull-params = val, val, val, val
0x012F	SUMXMY2
	sumxmy2-params = val, val
0x0130	SUMX2MY2
	sumx2my2-params = val, val
0x0131	SUMX2PY2
	sumx2py2-params = val, val
0x0132	CHITEST
	chitest-params = val, val
0x0133	CORREL
	correl-params = val, val
0x0134	COVAR
	covar-params = val, val
0x0135	FORECAST
	forecast-params = val, val, val
0x0136	FTEST
	ftest-params = val, val
0x0137	INTERCEPT
	intercept-params = val, val
0x0138	PEARSON
	pearson-params = val, val
0x0139	RSQ
	rsq-params = val, val
0x013A	STEYX
	steyx-params = val, val

Value	Meaning
0x013B	SLOPE
	slope-params = val, val
0x013C	TTEST
	ttest-params = val, val, val, val
0x013D	PROB
	prob-params = val, val, val, [val]
0x013E	DEVSQ
	devsq-params = (ref / val), *29(ref / val)
0x013F	GEOMEAN
	geomean-params = (ref / val), *29(ref / val)
0x0140	HARMEAN
	harmean-params = (ref / val), *29(ref / val)
0x0141	SUMSQ
	sumsq-params = (ref / val), *29(ref / val)
0x0142	KURT
	kurt-params = (ref / val), *29(ref / val)
0x0143	SKEW
	skew-params = (ref / val), *29(ref / val)
0x0144	ZTEST
	ztest-params = (ref / val), val, [val]
0x0145	LARGE
	large-params = (ref / val), val
0x0146	SMALL
	small-params = (ref / val), val
0x0147	QUARTILE
	quartile-params = (ref / val), val
0x0148	PERCENTILE
	percentile-params = (ref / val), val
0x0149	PERCENTRANK
	percentrank-params = (ref / val), val, [val]
0x014A	MODE
	mode-params = val, *29(val)

Value	Meaning
0x014B	TRIMMEAN
	trimmean-params = (ref / val), val
0x014C	TINV
	tinvs-params = val, val
0x014E	MOVIE.COMMAND
	movie-command-params = val, val, val, [val]
0x014F	GET.MOVIE
	get-movie-params = val, val, [val]
0x0150	CONCATENATE
	concatenate-params = val, *29(val)
0x0151	POWER
	power-params = val, val
0x0152	PIVOT.ADD.DATA
	pivot-add-data-params = val, val, [val, [val, [val, [val, *3(val)]]]]
0x0153	GET.PIVOT.TABLE
	get-pivot-table-params = val, [val]
0x0154	GET.PIVOT.FIELD
	get-pivot-field-params = val, [val, [val]]
0x0155	GET.PIVOT.ITEM
	get-pivot-item-params = val, [val, [val, [val]]]
0x0156	RADIANS
	radians-params = val
0x0157	DEGREES
	degrees-params = val
0x0158	SUBTOTAL
	subtotal-params = val, ref, *28(ref)
0x0159	SUMIF
	sumif-params = ref, val, [ref]
0x015A	COUNTIF
	countif-params = ref, val
0x015B	COUNTBLANK
	countblank-params = ref

Value	Meaning
0x015C	SCENARIO.GET
	scenario-get-params = val, [val]
0x015D	OPTIONS.LISTS.GET
	options-lists-get-params = val
0x015E	ISPMT
	ispmt-params = val, val, val, val
0x015F	DATEDIF
	datedif-params = val, val, val
0x0160	DATESTRING
	datestring-params = val
0x0161	NUMBERSTRING
	numberstring-params = val, val
0x0162	ROMAN
	roman-params = val, [val]
0x0163	OPEN.DIALOG
	open-dialog-params = [val, [val, [val, [val]]]]
0x0164	SAVE.DIALOG
	save-dialog-params = [val, [val, [val, [val, [val]]]]]
0x0165	VIEW.GET
	view-get-params = val, [val]
0x0166	GETPIVOTDATA
	getpivotdata-params = (ref / val), (ref / val), [val, [val, *13(val, val)]]
0x0167	HYPERLINK
	hyperlink-params = val, [val]
0x0168	PHONETIC
	phonetic-params = ref
0x0169	AVERAGEA
	averagea-params = (ref / val), *29(ref / val)
0x016A	MAXA
	maxa-params = (ref / val), *29(ref / val)
0x016B	MINA
	mina-params = (ref / val), *29(ref / val)

Value	Meaning
0x016C	STDEVPA
	stdevpa-params = (ref / val), *29(ref / val)
0x016D	VARPA
	varpa-params = (ref / val), *29(ref / val)
0x016E	STDEVA
	stdeva-params = (ref / val), *29(ref / val)
0x016F	VARA
	vara-params = (ref / val), *29(ref / val)
0x0170	BAHTTEXT
	bahttext-params = val
0x0171	THAIDAYOFWEEK
	thaidayofweek-params = val
0x0172	THAIDIGIT
	thaidigit-params = val
0x0173	THAIMONTHOFYEAR
	thaimonthofyear-params = val
0x0174	THAINUMSOUND
	thainumsound-params = val
0x0175	THAINUMSTRING
	thainumstring-params = val
0x0176	THAISTRINGLENGTH
	thastringlength-params = val
0x0177	ISTHAIDIGIT
	isthaidigit-params = val
0x0178	ROUNDBAHTDOWN
	roundbahtdown-params = val
0x0179	ROUNDBAHTUP
	roundbahtup-params = val
0x017A	THAIYEAR
	thaiyear-params = val
0x017B	RTD
	rtd-params = val, val, val, *27(val)

The following grammar is used in the Rgce structure definition:

```
params-fixed = isna-params / iserror-params /  
    sin-params / cos-params / tan-params /  
    atan-params / sqrt-params /  
    exp-params / ln-params / log10-params /  
    abs-params / int-params / sign-params /  
    round-params / rept-params / mid-params /  
    len-params / value-params / not-params / mod-params /  
    dcount-params / dsum-params / daverage-params /  
    dmin-params / dmax-params / dstdev-params /  
    dvar-params / text-params / goto-params /  
    mirr-params / date-params /  
    time-params / day-params / month-params /  
    year-params / hour-params / minute-params /  
    second-params / areas-params /  
    rows-params / columns-params / absref-params /  
    relref-params / transpose-params /  
    type-params / deref-params / atan2-params /  
    asin-params / acos-params / isref-params /  
    get-formula-params / set-value-params / char-params /  
    lower-params / upper-params / proper-params /  
    exact-params / trim-params / replace-params /  
    code-params / iserr-params / istext-params /  
    isnumber-params / isblank-params / t-params /  
    n-params / fclose-params / fsize-params /  
    freadln-params / fread-params / fwriteln-params /  
    fwrite-params / datevalue-params / timevalue-params /  
    sln-params / syd-params / dialog-box-params /  
    clean-params / mdeterm-params / minverse-params /  
    mmult-params / while-params / initiate-params / request-params /  
    poke-params / execute-params / terminate-params /  
    fact-params / get-workspace-params / dproduct-params /  
    isnontext-params / dstdevp-params / dvarp-params /
```

islogical-params / dcounta-params / delete-bar-params /
unregister-params / replaceb-params / midb-params /
lenb-params / roundup-params / rounddown-params /
asc-params / dbcs-params / else-if-params /
sinh-params / cosh-params / tanh-params /
asinh-params / acosh-params / atanh-params /
dget-params / info-params / frequency-params / delete-toolbar-params /
reset-toolbar-params / evaluate-params / error-type-params /
enable-tool-params / press-tool-params / gammaln-params /
binomdist-params / chidist-params / chiinv-params /
combin-params / confidence-params / critbinom-params /
even-params / expondist-params / fdist-params /
finv-params / fisher-params / fisherinv-params /
floor-params / gammadist-params / gammainv-params /
ceiling-params / hypgeomdist-params / lognormdist-params /
loginv-params / negbinomdist-params / normdist-params /
normsdist-params / norminv-params / normsinv-params /
standardize-params / odd-params / permut-params /
poisson-params / tdist-params / weibull-params /
sumxmy2-params / sumx2my2-params / sumx2py2-params /
chitest-params / correl-params / covar-params /
forecast-params / ftest-params / intercept-params /
pearson-params / rsq-params / steyx-params /
slope-params / ttest-params / large-params /
small-params / quartile-params / percentile-params /
trimmean-params / tinv-params / power-params /
radians-params / degrees-params / countif-params /
countblank-params / options-lists-get-params / ispmt-params /
datedif-params / datestring-params / numberstring-params /
phonetic-params / bahttext-params / thaidayofweek-params /
thaidigit-params / thaimonthofyear-params / thainumsound-params /
thainumstring-params / thaistringlength-params / isthaidigit-params /
roundbahtdown-params / roundbahtup-params / thaiyear-params

params-variable = count-params / if-params / sum-params /
average-params / min-params / max-params /
row-params / column-params / npv-params /
stdev-params / dollar-params / fixed-params /
lookup-params / index-params / and-params /
or-params / var-params / linest-params /
trend-params / logest-params / growth-params /
halt-params / return-params / pv-params /
fv-params / nper-params / pmt-params /
rate-params / irr-params / match-params /
weekday-params / offset-params / argument-params /
search-params / error-params / echo-params /
set-name-params / windows-params / series-params /
documents-params / result-params / choose-params /
hlookup-params / vlookup-params / links-params /
input-params / get-name-params / log-params /
exec-params / left-params / right-params /
substitute-params / names-params / directory-params /
find-params / cell-params / fopen-params /
fpos-params / ddb-params / get-def-params /
reftext-params / textref-params / indirect-params /
register-params / call-params / add-bar-params /
add-menu-params / add-command-params / enable-command-params /
check-command-params / rename-command-params / show-bar-params /
delete-menu-params / delete-command-params / get-chart-item-params /
files-params / ipmt-params / ppmt-params /
counta-params / cancel-key-params / for-params /
restart-params / help-params / get-bar-params /
product-params / get-cell-params / get-window-params /
get-document-params / get-note-params / note-params /
stdevp-params / varp-params / trunc-params /
usdollar-params / findb-params / searchb-params /
leftb-params / rightb-params / rank-params /

address-params / days360-params / vdb-params /
 for-cell-params / median-params / sumproduct-params /
 create-object-params / volatile-params / custom-undo-params /
 custom-repeat-params / formula-convert-params / get-link-info-params /
 text-box-params / get-object-params / db-params /
 pause-params / resume-params / add-toolbar-params /
 user-defined-function-params / get-toolbar-params / get-tool-params /
 spelling-check-params / app-title-params / window-title-params /
 save-toolbar-params / register-id-params / get-workbook-params /
 avedev-params / betadist-params / betainv-params /
 prob-params / devsq-params / geomean-params /
 harmean-params / sumsq-params / kurt-params /
 skew-params / ztest-params / percentrank-params /
 mode-params / movie-command-params / get-movie-params /
 concatenate-params / pivot-add-data-params / get-pivot-table-params /
 get-pivot-field-params / get-pivot-item-params / subtotal-params /
 sumif-params / scenario-get-params / roman-params /
 open-dialog-params / save-dialog-params / view-get-params /
 getpivotdata-params / hyperlink-params / averagea-params /
 maxa-params / mina-params / stdevpa-params /
 varpa-params / stdeva-params / vara-params /
 rtd-params

2.5.198.18 Ilel

The **Ilel** structure specifies a deleted label in use by a **natural language formula**.<176>

0	1	2	3	4	5	6	7	8	9	10	1	2	3	4	5	6	7	8	9	20	1	2	3	4	5	6	7	8	9	30	1
ilel																															

ilel (2 bytes): An unsigned integer used to calculate the index into the collection of [Lel](#) records in the [Globals Substream](#). The referenced Lel specifies the deleted label in use. MUST be a value from the following table.

Value	Meaning
0	Invalid index. The number of deleted labels is greater than 2047, the maximum size of the array of deleted labels.
1	Invalid index.

Value	Meaning
Greater than 1 and less than or equal to 2048	The one-based index plus 1 of the Lel record.

2.5.198.19 ListParsedArrayFormula

The **ListParsedArrayFormula** structure specifies a formula (section [2.2.2](#)) used in a **table**.

0	1	2	3	4	5	6	7	8	9	10	11	12	13	14	15	16	17	18	19	20	21	22	23	24	25	26	27	28	29	30	31
cce																rgce (variable)															
...																															
rgcb (variable)																															
...																															

cce (2 bytes): An unsigned integer that specifies the length of **rgce** in bytes. MUST be greater than 0.

rgce (variable): An [Rgce](#) that specifies the sequence of Ptgs for the formula. MUST NOT contain [PtgExp](#), [PtgTbl](#), [PtgElfLel](#), [PtgElfRw](#), [PtgElfCol](#), [PtgElfRwV](#), [PtgElfColV](#), [PtgElfRadical](#), [PtgElfRadicalS](#), [PtgElfColS](#), [PtgElfColSV](#), [PtgElfRadicalLel](#), or [PtgSxName](#).

rgcb (variable): An [RgbExtra](#) that specifies ancillary data for the formula.

2.5.198.20 ListParsedFormula

The **ListParsedFormula** structure specifies a formula (section [2.2.2](#)) used in a **table**.

0	1	2	3	4	5	6	7	8	9	10	11	12	13	14	15	16	17	18	19	20	21	22	23	24	25	26	27	28	29	30	31
cce																rgce (variable)															
...																															

cce (2 bytes): An unsigned integer that specifies the length of **rgce** in bytes. MUST be greater than 0.

rgce (variable): An [Rgce](#) that specifies the sequence of Ptgs for the formula. MUST NOT contain [PtgExp](#), [PtgTbl](#), [PtgElfLel](#), [PtgElfRw](#), [PtgElfCol](#), [PtgElfRwV](#), [PtgElfColV](#), [PtgElfRadical](#), [PtgElfRadicalS](#), [PtgElfColS](#), [PtgElfColSV](#), [PtgElfRadicalLel](#), or [PtgSxName](#).

2.5.198.21 NameParsedFormula

The **NameParsedFormula** structure specifies a formula (section [2.2.2](#)) used in a **defined name**.

0	1	2	3	4	5	6	7	8	9	1	0	1	2	3	4	5	6	7	8	9	2	0	1	2	3	4	5	6	7	8	9	3	0	1
rgce (variable)																																		
...																																		
rgcb (variable)																																		
...																																		

rgce (variable): An [Rgce](#) that specifies the sequence of PtgS for the formula. MUST NOT contain [PtgExp](#), [PtgTbl](#), [PtgElfLel](#), [PtgElfRw](#), [PtgElfCol](#), [PtgElfRwV](#), [PtgElfColV](#), [PtgElfRadical](#), [PtgElfRadicalS](#), [PtgElfColS](#), [PtgElfColSV](#), [PtgElfRadicalLel](#), [PtgSxName](#), [PtgRef](#), [PtgRefN](#), [PtgRefErr](#), [PtgArea](#), [PtgAreaN](#), or [PtgAreaErr](#). The size of **rgce** in bytes is specified by the **cce** field of the [Lbl](#) record.

rgcb (variable): An [RgbExtra](#) that specifies ancillary data for the formula.

2.5.198.22 ObjectParsedFormula

The **ObjectParsedFormula** structure specifies a formula (section [2.2.2](#)) used by an **embedded object**.

0	1	2	3	4	5	6	7	8	9	1	0	1	2	3	4	5	6	7	8	9	2	0	1	2	3	4	5	6	7	8	9	3	0	1
cce											A	unused (optional)																						
...												rgce (variable)																						
...																																		

cce (15 bits): An unsigned integer that specifies the length of **rgce** in bytes. MUST be greater than 0.

A - reserved (1 bit): MUST be zero, and MUST be ignored.

unused (4 bytes): Undefined and MUST be ignored.

rgce (variable): An [Rgce](#) that specifies the sequence of PtgS for the formula. MUST contain one Ptg only, and this Ptg MUST be [PtgTbl](#), [PtgName](#), [PtgNameX](#), [PtgErr](#), [PtgRef](#), [PtgRefErr](#), [PtgRef3d](#), [PtgRefErr3d](#), [PtgArea](#), [PtgAreaErr](#), [PtgArea3d](#), or [PtgAreaErr3d](#).

2.5.198.23 ParameterParsedFormula

The **ParameterParsedFormula** structure specifies a formula (section [2.2.2](#)) for a query parameter.

0	1	2	3	4	5	6	7	8	9	1	0	1	2	3	4	5	6	7	8	9	2	0	1	2	3	4	5	6	7	8	9	3	0	1
cce												rgce (variable)																						
...																																		

cce (2 bytes): An unsigned integer that specifies the length of **rgce** in bytes. MUST be greater than 0.

rgce (variable): An [Rgce](#) that specifies the sequence of Ptgs for the formula. MUST NOT contain [PtgExp](#), [PtgTbl](#), [PtgArray<177>](#), [PtgMemArea](#), [PtgElfLel](#), [PtgElfRw](#), [PtgElfCol](#), [PtgElfRwV](#), [PtgElfColV](#), [PtgElfRadical](#), [PtgElfRadicalS](#), [PtgElfColS](#), [PtgElfColSV](#), [PtgElfRadicalLel](#), or [PtgSxName](#).

The root node of the parse tree of this field MUST NOT be a VALUE_TYPE, as described in Rgce.

2.5.198.24 PivotParsedFormula

The **PivotParsedFormula** structure specifies a formula (section [2.2.2](#)) used in a [PivotTable](#).

0	1	2	3	4	5	6	7	8	9	10	11	12	13	14	15	16	17	18	19	20	21	22	23	24	25	26	27	28	29	30	31
cce											cSxName																				
rgce (variable)																															
...																															

cce (2 bytes): An unsigned integer that specifies the length of **rgce** in bytes.

cSxName (2 bytes): An unsigned integer that specifies number of contiguous [SxName](#) records that follow the [SxFmla](#) record that contains this formula.

rgce (variable): An [Rgce](#) that specifies the sequence of Ptgs for the formula. MUST NOT contain [PtgExp](#), [PtgTbl](#), [PtgUnion](#), [PtgIsect](#), [PtgRange](#), [PtgArray](#), [PtgAttrSpaceSemi](#), [PtgAttrSemi](#), [PtgElfLel](#), [PtgElfRw](#), [PtgElfCol](#), [PtgElfRwV](#), [PtgElfColV](#), [PtgElfRadical](#), [PtgElfRadicalS](#), [PtgElfColS](#), [PtgElfColSV](#), [PtgElfRadicalLel](#), [PtgRef](#), [PtgRefErr](#), [PtgRefN](#), [PtgArea](#), [PtgAreaErr](#), [PtgAreaN](#), [PtgRef3d](#), [PtgArea3d](#), [PtgRefErr3d](#), [PtgAreaErr3d](#), [PtgName](#), [PtgNameX](#), [PtgMemArea](#), [PtgMemErr](#), [PtgMemNoMem](#), or [PtgMemFunc](#).

If this field contains a [PtgFunc](#), then the **iftab** field of the PtgFunc MUST be less than 0x0028 or greater than 0x002D and MUST NOT be equal to 0x002F, 0x00BD, 0x00C3, 0x00C4, or 0x00C7.

If this field contains a [PtgFuncVar](#), then the **fCeFunc** field of the PtgFuncVar MUST be 0 and the **tab** field of the PtgFuncVar MUST NOT be equal to 0x00FF or 0x0166.

The root node of the parse tree of this field MUST be a VALUE_TYPE, as described in Rgce.

2.5.198.25 Ptg

The **Ptg** structure specifies a single element of a formula (section [2.2.2](#)). The value of the first byte determines which structure it represents and MUST be one of the values in the first column of the following table. If the value of the first byte is 0x18 or 0x19, then the second byte determines which structure it represents and MUST be one of the values in the second column of the following table.

First byte	Second byte	Ptg
0x01		PtgExp
0x02		PtgTbl
0x03		PtgAdd
0x04		PtgSub
0x05		PtgMul

First byte	Second byte	Ptg
0x06		PtgDiv
0x07		PtgPower
0x08		PtgConcat
0x09		PtgLt
0x0A		PtgLe
0x0B		PtgEq
0x0C		PtgGe
0x0D		PtgGt
0x0E		PtgNe
0x0F		PtgIsect
0x10		PtgUnion
0x11		PtgRange
0x12		PtgUplus
0x13		PtgUminus
0x14		PtgPercent
0x15		PtgParen
0x16		PtgMissArg
0x17		PtgStr
0x18	0x01	PtgElfLel
0x18	0x02	PtgElfRw
0x18	0x03	PtgElfCol
0x18	0x06	PtgElfRwV
0x18	0x07	PtgElfColV
0x18	0x0A	PtgElfRadical
0x18	0x0B	PtgElfRadicalS
0x18	0x0D	PtgElfColS
0x18	0x0F	PtgElfColSV
0x18	0x10	PtgElfRadicalLel
0x18	0x1D	PtgSxName
0x19	0x01	PtgAttrSemi
0x19	0x02	PtgAttrIf
0x19	0x04	PtgAttrChoose
0x19	0x08	PtgAttrGoto
0x19	0x10	PtgAttrSum
0x19	0x20	PtgAttrBaxcel
0x19	0x21	PtgAttrBaxcel
0x19	0x40	PtgAttrSpace
0x19	0x41	PtgAttrSpaceSemi
0x1C		PtgErr
0x1D		PtgBool

First byte	Second byte	Ptg
0x1E		PtgInt
0x1F		PtgNum
0x20		PtgArray
0x21		PtgFunc
0x22		PtgFuncVar
0x23		PtgName
0x24		PtgRef
0x25		PtgArea
0x26		PtgMemArea
0x27		PtgMemErr
0x28		PtgMemNoMem
0x29		PtgMemFunc
0x2A		PtgRefErr
0x2B		PtgAreaErr
0x2C		PtgRefN
0x2D		PtgAreaN
0x39		PtgNameX
0x3A		PtgRef3d
0x3B		PtgArea3d
0x3C		PtgRefErr3d
0x3D		PtgAreaErr3d
0x40		PtgArray
0x41		PtgFunc
0x42		PtgFuncVar
0x43		PtgName
0x44		PtgRef
0x45		PtgArea
0x46		PtgMemArea
0x47		PtgMemErr
0x48		PtgMemNoMem
0x49		PtgMemFunc
0x4A		PtgRefErr
0x4B		PtgAreaErr
0x4C		PtgRefN
0x4D		PtgAreaN
0x59		PtgNameX
0x5A		PtgRef3d
0x5B		PtgArea3d
0x5C		PtgRefErr3d
0x5D		PtgAreaErr3d

First byte	Second byte	Ptg
0x60		PtgArray
0x61		PtgFunc
0x62		PtgFuncVar
0x63		PtgName
0x64		PtgRef
0x65		PtgArea
0x66		PtgMemArea
0x67		PtgMemErr
0x68		PtgMemNoMem
0x69		PtgMemFunc
0x6A		PtgRefErr
0x6B		PtgAreaErr
0x6C		PtgRefN
0x6D		PtgAreaN
0x79		PtgNameX
0x7A		PtgRef3d
0x7B		PtgArea3d
0x7C		PtgRefErr3d
0x7D		PtgAreaErr3d

2.5.198.26 PtgAdd

The **PtgAdd** structure specifies a [binary-value-operator](#) that adds the second expression in a binary-value-expression to the first.

0	1	2	3	4	5	6	7	8	9	10	11	12	13	14	15	16	17	18	19	20	21	22	23	24	25	26	27	28	29	30	31
ptg										A																					

ptg (7 bits): Reserved. MUST be 0x03.

A - reserved0 (1 bit): MUST be zero, and MUST be ignored.

2.5.198.27 PtgArea

The **PtgArea** [operand](#) specifies a reference to a rectangular **range** of **cells**.

0	1	2	3	4	5	6	7	8	9	10	11	12	13	14	15	16	17	18	19	20	21	22	23	24	25	26	27	28	29	30	31
ptg							A	B	area																						

...															
...															

ptg (5 bits): Reserved. MUST be 0x05.

A - type (2 bits): A [PtgDataType](#) that specifies the data type for the value of this Ptg.

B - reserved (1 bit): MUST be zero, and MUST be ignored.

area (8 bytes): A [RgceArea](#) that specifies the referenced range of cells.

2.5.198.28 PtgArea3d

The **PtgArea3d operand** specifies a reference to the same rectangular **range of cells** on one or more **sheets**. If the formula (section [2.2.2](#)) containing this structure is part of a revision as specified in the Formulas overview, then there MUST be a [RevExtern](#) in the [RqbExtra](#) corresponding to this PtgArea3d, which specifies those sheets.

0	1	2	3	4	5	6	7	8	9	10	11	12	13	14	15	16	17	18	19	20	21	22	23	24	25	26	27	28	29	30	31
ptg					A	B	ixti										area														
...																															
...																															

ptg (5 bits): Reserved. MUST be 0x1B.

A - type (2 bits): A [PtgDataType](#) that specifies the required data type for the value of the Ptg

B - reserved (1 bit): MUST be zero, and MUST be ignored.

ixti (2 bytes): If the formula containing this structure is not part of a revision as specified in the Formulas overview, then this value is an [XtiIndex](#) that specifies the [XTI](#) which specifies those sheets. Otherwise it is undefined and MUST be ignored.

area (8 bytes): A value that specifies coordinates of the referenced range of cells. If this PtgArea3d is part of a [NameParsedFormula](#) then this is an [RgceAreaRel](#) value. Otherwise it is an [RgceArea](#) value.

2.5.198.29 PtgAreaErr

The **PtgAreaErr operand** specifies an invalid reference to a **cell range**.

0	1	2	3	4	5	6	7	8	9	10	11	12	13	14	15	16	17	18	19	20	21	22	23	24	25	26	27	28	29	30	31
ptg					A	B	unused1										unused2														
...					unused3												unused4														
...																															

ptg (5 bits): Reserved. MUST be 0x0B.

A - type (2 bits): A [PtgDataType](#) that specifies the data type for the value of this [Ptg](#).

B - reserved (1 bit): MUST be zero, and MUST be ignored.

unused1 (2 bytes): Undefined and MUST be ignored.

unused2 (2 bytes): Undefined and MUST be ignored.

unused3 (2 bytes): Undefined and MUST be ignored.

unused4 (2 bytes): Undefined and MUST be ignored.

2.5.198.30 PtgAreaErr3d

PtgAreaErr3d operand specifies an invalid reference to the same rectangular **range** of **cells** on one or more **sheets**. If the formula (section [2.2.2](#)) containing this structure is part of a revision as specified in the Formulas overview, then there MUST be a [RevExtern](#) in the [RqbExtra](#) corresponding to this PtgAreaErr3d, which specifies those sheets.

0	1	2	3	4	5	6	7	8	9	10	11	12	13	14	15	16	17	18	19	20	21	22	23	24	25	26	27	28	29	30	31
ptg					A		B	ixti															unused1								
...								unused2															unused3								
...								unused4																							

ptg (5 bits): Reserved. MUST be 0x1D.

A - type (2 bits): A [PtgDataType](#) that specifies the required data type for the value of the [Ptg](#).

B - reserved (1 bit): MUST be zero, and MUST be ignored.

ixti (2 bytes): If the formula containing this structure is not part of a revision as specified in the Formulas overview, then this value is an [XtiIndex](#) that specifies the [XTI](#) which specifies those sheets. Otherwise it is undefined and MUST be ignored.

unused1 (2 bytes): Undefined and MUST be ignored.

unused2 (2 bytes): Undefined and MUST be ignored.

unused3 (2 bytes): Undefined and MUST be ignored.

unused4 (2 bytes): Undefined and MUST be ignored.

2.5.198.31 PtgAreaN

The **PtgAreaN operand** specifies a reference to a rectangular **range** of **cells** as an [RqceAreaRel](#).

0	1	2	3	4	5	6	7	8	9	10	11	12	13	14	15	16	17	18	19	20	21	22	23	24	25	26	27	28	29	30	31
ptg					A		B	area																							

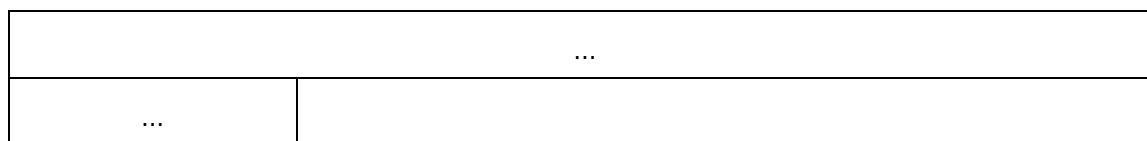

ptg (5 bits): Reserved. MUST be 0x0D.

A - type (2 bits): A [PtgDataType](#) that specifies the data type for the value of this Ptg.

B - reserved (1 bit): MUST be zero, and MUST be ignored.

area (8 bytes): An RgceAreaRel that specifies the referenced range.

2.5.198.32 PtgArray

The **PtgArray operand** specifies an array of values. There MUST be a [PtgExtraArray](#) in the [RgbExtra](#) corresponding to this PtgArray. The correspondence between PtgArray and PtgExtraArray structures is specified in RgbExtra.

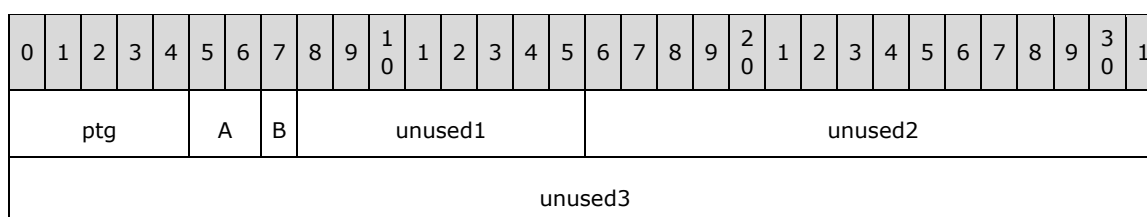

ptg (5 bits): Reserved. MUST be 0x00.

A - type (2 bits): A [PtgDataType](#) that specifies the data type for this array. MUST be 2 or 3.

B - reserved (1 bit): MUST be zero, and MUST be ignored.

unused1 (1 byte): Undefined and MUST be ignored.

unused2 (2 bytes): Undefined and MUST be ignored.

unused3 (4 bytes): Undefined and MUST be ignored.

2.5.198.33 PtgAttrBaxcel

The **PtgAttrBaxcel** structure specifies that the result of the [Rgce](#) is to be assigned to a local variable used in a **macro sheet**.

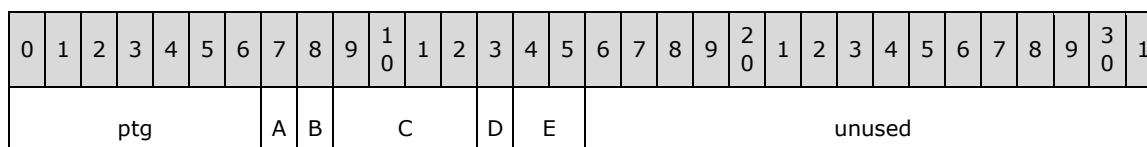

ptg (7 bits): Reserved. MUST be 0x19.

A - reserved1 (1 bit): MUST be zero, and MUST be ignored.

B - bitSemi (1 bit): A bit that specifies whether this Rgce is **volatile**.

C - reserved2 (4 bits): MUST be zero, and MUST be ignored.

D - bitBaxcel (1 bit): Reserved. MUST be 1.

E - reserved3 (2 bits): MUST be zero, and MUST be ignored.

unused (2 bytes): Undefined and MUST be ignored.

2.5.198.34 PtgAttrChoose

The **PtgAttrChoose** structure specifies a [control token](#).

0	1	2	3	4	5	6	7	8	9	10	11	12	13	14	15	16	17	18	19	20	21	22	23	24	25	26	27	28	29	30	31
ptg							A	B	C	reserved3					cOffset																
rgOffset (variable)																															
...																															

ptg (7 bits): Reserved. MUST be 0x19.

A - reserved1 (1 bit): MUST be zero, and MUST be ignored.

B - reserved2 (2 bits): MUST be zero, and MUST be ignored.

C - bitChoose (1 bit): Reserved. MUST be 1.

reserved3 (5 bits): MUST be zero, and MUST be ignored.

cOffset (2 bytes): An unsigned integer that specifies a value which is 1 less than the number of elements in **rgOffset**.

rgOffset (variable): An array of 2-byte unsigned integers that specifies the byte offsets.

2.5.198.35 PtgAttrGoto

The **PtgAttrGoto** structure specifies a [control token](#).

0	1	2	3	4	5	6	7	8	9	10	11	12	13	14	15	16	17	18	19	20	21	22	23	24	25	26	27	28	29	30	31
ptg							A	B	C	D	offset																				

ptg (7 bits): Reserved. MUST be 0x19.

A - reserved1 (1 bit): MUST be zero, and MUST be ignored.

B - reserved2 (3 bits): MUST be zero, and MUST be ignored.

C - bitGoto (1 bit): If the formula (section [2.2.2](#)) containing this structure is not part of a [ArrayParsedFormula](#) then the bit is reserved and MUST be 1. If the formula containing this structure is part of an [ArrayParsedFormula](#), then the bit is undefined and MUST be ignored.

D - reserved3 (4 bits): MUST be zero, and MUST be ignored.

offset (2 bytes): An unsigned integer that specifies a value 1 less than the byte offset.

2.5.198.36 PtgAttrIf

The **PtgAttrIf** structure specifies a [control token](#).

0	1	2	3	4	5	6	7	8	9	10	11	12	13	14	15	16	17	18	19	20	1	2	3	4	5	6	7	8	9	30	1
ptg							A	B	C	reserved3						offset															

ptg (7 bits): Reserved. MUST be 0x19.

A - reserved1 (1 bit): MUST be zero, and MUST be ignored.

B - reserved2 (1 bit): MUST be zero, and MUST be ignored.

C - bitIf (1 bit): Reserved. MUST be 1

reserved3 (6 bits): MUST be zero, and MUST be ignored.

offset (2 bytes): An unsigned integer that specifies the byte offset.

2.5.198.37 PtgAttrSemi

The **PtgAttrSemi** structure specifies that this [Rqce](#) is **volatile**.

0	1	2	3	4	5	6	7	8	9	10	11	12	13	14	15	16	17	18	19	20	1	2	3	4	5	6	7	8	9	30	1
ptg							A	B	reserved2						unused																

ptg (7 bits): Reserved. MUST be 0x19.

A - reserved1 (1 bit): MUST be zero, and MUST be ignored.

B - bitSemi (1 bit): Reserved. MUST be 1.

reserved2 (7 bits): MUST be zero, and MUST be ignored.

unused (2 bytes): Undefined and MUST be ignored.

2.5.198.38 PtgAttrSpace

The **PtgAttrSpace** [display token](#) specifies a number of space or carriage return characters that are displayed around the expression in a [display-precedence-expression](#).

0	1	2	3	4	5	6	7	8	9	10	11	12	13	14	15	16	17	18	19	20	1	2	3	4	5	6	7	8	9	30	1
ptg							A	reserved2						B	C	type															

ptg (7 bits): Reserved. MUST be 0x19.

A - reserved1 (1 bit): MUST be zero, and MUST be ignored.

reserved2 (6 bits): MUST be zero, and MUST be ignored.

B - bitSpace (1 bit): Reserved. MUST be 1.

C - reserved3 (1 bit): MUST be zero, and MUST be ignored.

type (2 bytes): A [PtgAttrSpaceType](#) that specifies a number of space or carriage return characters and the position of those characters

2.5.198.39 PtgAttrSpaceSemi

The **PtgAttrSpaceSemi** structure specifies a number of space or carriage return characters that are displayed around the expression in a [display-precedence-specifier](#) and that the Rgce is **volatile**.

0	1	2	3	4	5	6	7	8	9	10	11	12	13	14	15	16	17	18	19	20	1	2	3	4	5	6	7	8	9	30	1
ptg							A	reserved2										type													

ptg (7 bits): Reserved. MUST be 0x19.

A - reserved1 (1 bit): MUST be zero, and MUST be ignored.

reserved2 (1 byte): Reserved. MUST be 0x41.

type (2 bytes): A [PtgAttrSpaceType](#) that specifies a number of space or carriage return characters and position of those characters

2.5.198.40 PtgAttrSpaceType

The **PtgAttrSpaceType** structure specifies the number of space or carriage return characters and position of those characters.

0	1	2	3	4	5	6	7	8	9	10	11	12	13	14	15	16	17	18	19	20	1	2	3	4	5	6	7	8	9	30	1
type										cch																					

type (1 byte): An unsigned integer that specifies the character and position of the character. MUST be a value from the following table:

Value	Meaning
0x00	Specifies space characters before a base-expression .
0x01	Specifies carriage return characters before a base-expression.
0x02	Specifies space characters before the open parenthesis specified by PtgParen in a display-precedence-specifier.
0x03	Specifies carriage return characters before the open parenthesis specified by PtgParen in a display-precedence-specifier.
0x04	Specifies space characters before the close parenthesis specified by PtgParen in a display-precedence-specifier.
0x05	Specifies carriage return characters before the close parenthesis specified by PtgParen in a display-precedence-specifier.
0x06	Specifies space characters before an expression.

cch (1 byte): An unsigned integer that specifies the number of characters.

2.5.198.41 PtgAttrSum

The **PtgAttrSum** structure specifies the sum of an expression as defined in [function-call](#).

0	1	2	3	4	5	6	7	8	9	10	11	12	13	14	15	16	17	18	19	20	21	22	23	24	25	26	27	28	29	30	31
ptg							A	B				C	D	unused																	

ptg (7 bits): Reserved. MUST be 0x19.

A - reserved1 (1 bit): MUST be zero, and MUST be ignored.

B - reserved2 (4 bits): MUST be zero, and MUST be ignored.

C - bitSum (1 bit): Reserved. MUST be 1.

D - reserved3 (3 bits): MUST be zero, and MUST be ignored.

unused (2 bytes): Undefined and MUST be ignored.

2.5.198.42 PtgBool

The **PtgBool** [operand](#) specifies a Boolean value.

0	1	2	3	4	5	6	7	8	9	10	11	12	13	14	15	16	17	18	19	20	21	22	23	24	25	26	27	28	29	30	31
ptg							A	boolean																							

ptg (7 bits): Reserved. MUST be 0x1D.

A - reserved0 (1 bit): MUST be zero, and MUST be ignored.

boolean (1 byte): A Boolean (section [2.5.14](#)) that specifies the value.

2.5.198.43 PtgConcat

The **PtgConcat** structure specifies a [binary-value-operator](#) that appends the second expression in binary-value-expression to the first.

0	1	2	3	4	5	6	7	8	9	10	11	12	13	14	15	16	17	18	19	20	21	22	23	24	25	26	27	28	29	30	31
ptg							A																								

ptg (7 bits): Reserved. MUST be 0x08.

A - reserved0 (1 bit): MUST be zero, and MUST be ignored.

2.5.198.44 PtgDataType

The **PtgDataType** enumeration specifies the data type of a [Ptg](#). MUST be a value from the following table:

Name	Value	Meaning
REFERENCE	0x1	Specifies a reference to a range .
VALUE	0x2	Specifies a single value of a simple type. The type can be a Boolean, a number, a string, or an error code.
ARRAY	0x3	Specifies an array of values.

2.5.198.45 PtgDiv

The **PtgDiv** structure specifies a [binary-value-operator](#) that divides the first expression in a binary-value-expression by the second.

0	1	2	3	4	5	6	7	8	9	10	11	12	13	14	15	16	17	18	19	20	21	22	23	24	25	26	27	28	29	30	31
ptg														A																	

ptg (7 bits): Reserved. MUST be 0x06.

A - reserved0 (1 bit): MUST be zero, and MUST be ignored.

2.5.198.46 PtgElfCol

The **PtgElfCol natural language formula operand** specifies a [reference class](#) reference to a **range** within a column which is represented by a single-cell **natural language label**.

0	1	2	3	4	5	6	7	8	9	10	11	12	13	14	15	16	17	18	19	20	21	22	23	24	25	26	27	28	29	30	31
ptg										eptg							loc														
...																															

ptg (1 byte): Reserved. MUST be 0x18.

eptg (1 byte): Reserved. MUST be 0x03.

loc (4 bytes): An [RqceElfLoc](#) that specifies the location of the label.

2.5.198.47 PtgElfColS

The **PtgElfColS natural language formula operand** specifies a [reference class](#) reference to a **range** within a column that is identified by a multiple-cell **natural language label**. There MUST be a [PtgExtraElf](#) in the [RgbExtra](#) corresponding to this PtgElfColS. The correspondence between PtgElfColS and PtgExtraElf structures is specified in RgbExtra.

0	1	2	3	4	5	6	7	8	9	10	11	12	13	14	15	16	17	18	19	20	21	22	23	24	25	26	27	28	29	30	31
ptg										eptg							unused														
...																															

ptg (1 byte): Reserved. MUST be 0x18.

eptg (1 byte): Reserved. MUST be 0x0D.

unused (4 bytes): Undefined and MUST be ignored.

2.5.198.48 PtgElfColSV

The **PtgElfColSV natural language formula operand** specifies a [value class](#) reference to a **range** within a column that is identified by a multiple-cell **natural language label**. There MUST be a [PtgExtraElf](#) in the [RgbExtra](#) corresponding to this PtgElfColSV. The correspondence between PtgElfColSV and PtgExtraElf structures is specified in RgbExtra.

0	1	2	3	4	5	6	7	8	9	10	11	12	13	14	15	16	17	18	19	20	21	22	23	24	25	26	27	28	29	30	31
ptg										eptg										unused											
...																															

ptg (1 byte): Reserved. MUST be 0x18.

eptg (1 byte): Reserved. MUST be 0x0F.

unused (4 bytes): Undefined and MUST be ignored.

2.5.198.49 PtgElfColV

The **PtgElfColV natural language formula operand** specifies a [value class](#) reference to a **range** within a column which is represented by a single-cell **natural language label**.

0	1	2	3	4	5	6	7	8	9	10	11	12	13	14	15	16	17	18	19	20	21	22	23	24	25	26	27	28	29	30	31
ptg										eptg										loc											
...																															

ptg (1 byte): Reserved. MUST be 0x18.

eptg (1 byte): Reserved. MUST be 0x07.

loc (4 bytes): An [RqceElfLoc](#) that specifies the location of the label.

2.5.198.50 PtgElfLel

The **PtgElfLel natural language formula operand** specifies a reference to a **range** which is represented by a single-cell **natural language label** or a multiple-cell natural language label that has been deleted.

0	1	2	3	4	5	6	7	8	9	10	11	12	13	14	15	16	17	18	19	20	21	22	23	24	25	26	27	28	29	30	31
ptg										eptg										ilel											

A	reserved
---	----------

ptg (1 byte): Reserved. MUST be 0x18.

eptg (1 byte): Reserved. MUST be 0x01.

ilel (2 bytes): An [Ilel](#) that specifies the deleted label.

A - fQuoted (1 bit): A bit that specifies whether the occurrences of the label specified in **ilel** are surrounded by single quote characters in the formula (section [2.2.2](#)).

reserved (15 bits): MUST be zero, and MUST be ignored.

2.5.198.51 PtgElfRadical

The **PtgElfRadical natural language formula operand** specifies a [reference class](#) reference to a **range** that is represented by a single-cell **natural language label**. The range is specified by [PtgArea](#) or [PtgAreaErr](#) that follows this PtgElfRadical in the formula (section [2.2.2](#)). If this structure is followed in the formula by PtgArea, then one but not both of the following MUST be true:

- The **area.rowFirst** field is equal to the **area.rowLast** field of PtgArea, and the **loc** field specifies a label location that is adjacent to the range specified by the **area** field of PtgArea. The **loc.row** field of this PtgElfRadical is equal to the **area.rowFirst** field of PtgArea
- The **area.columnFirst** field is equal to the **area.columnLast** field of PtgArea, and the **loc** field specifies a label location that is adjacent to the range specified by the area field of PtgArea. The **loc.col** field of this PtgElfRadical is equal to the **area.columnFirst** field of PtgArea

0	1	2	3	4	5	6	7	8	9	10	11	12	13	14	15	16	17	18	19	20	21	22	23	24	25	26	27	28	29	30	31
ptg										eptg										loc											
...																															

ptg (1 byte): Reserved. MUST be 0x18.

eptg (1 byte): Reserved. MUST be 0x0A.

loc (4 bytes): An [RcceElfLoc](#) that specifies the location of the label.

2.5.198.52 PtgElfRadicalLeI

The **PtgElfRadicalLeI natural language formula operand** specifies a [reference class](#) reference to a **range** which is represented by a single-cell **natural language label** or a multiple-cell natural language label that has been deleted.

0	1	2	3	4	5	6	7	8	9	10	11	12	13	14	15	16	17	18	19	20	21	22	23	24	25	26	27	28	29	30	31
ptg										eptg										ilel											
A	reserved																														

ptg (1 byte): Reserved. MUST be 0x18.

eptg (1 byte): Reserved. MUST be 0x10.

ilel (2 bytes): An [Ilel](#) that specifies the deleted label.

A - fQuoted (1 bit): A bit that specifies whether the occurrences of the label specified in **ilel** are surrounded by single quote characters in the formula (section [2.2.2](#)).

reserved (15 bits): MUST be zero, and MUST be ignored.

2.5.198.53 PtgElfRadicals

The **PtgElfRadicals natural language formula operand** specifies a [reference class](#) reference to a **range** which is represented by a multiple-cell **natural language label**. The range is specified by the [PtgArea](#) or [PtgAreaErr](#) record which follows this PtgElfRadicals in the formula (section [2.2.2](#)). There MUST be a [PtgExtraElf](#) in the [RgbExtra](#) corresponding to this PtgElfRadicals. The correspondence between PtgElfRadicals and PtgExtraElf structures is specified in RgbExtra.

If this PtgElfRadicals is followed in the formula (section [2.2.2](#)) by PtgArea, then the **area.columnFirst** field and the **area.columnLast** field of the PtgArea MUST be equal. Additionally, the last element in the **array** field of the corresponding PtgExtraElf MUST specify a label location that is adjacent to the range specified by the **area** field of PtgArea. The **column.col** field of the last element in the **array** field of PtgExtraElf MUST also be equal to the **area.columnFirst** field of PtgArea.

0	1	2	3	4	5	6	7	8	9	10	11	12	13	14	15	16	17	18	19	20	21	22	23	24	25	26	27	28	29	30	31
ptg										eptg										unused											
...																															

ptg (1 byte): Reserved. MUST be 0x18.

eptg (1 byte): Reserved. MUST be 0x0B.

unused (4 bytes): Undefined and MUST be ignored.

2.5.198.54 PtgElfRw

The **PtgElfRw natural language formula operand** specifies a [reference class](#) reference to a **range** within a row which is represented by a single-cell **natural language label**.

0	1	2	3	4	5	6	7	8	9	10	11	12	13	14	15	16	17	18	19	20	21	22	23	24	25	26	27	28	29	30	31
ptg										eptg										loc											
...																															

ptg (1 byte): Reserved. MUST be 0x18.

eptg (1 byte): Reserved. MUST be 0x02.

loc (4 bytes): An [RqceElfLoc](#) that specifies the location of the label.

2.5.198.55 PtgElfRwV

The **PtgElfRwV natural language formula operand** specifies a [value class](#) reference to a **range** within a row which is represented by a single-cell **natural language label**.

0	1	2	3	4	5	6	7	8	9	10	11	12	13	14	15	16	17	18	19	20	1	2	3	4	5	6	7	8	9	30	1
ptg										eptg										loc											
...																															

ptg (1 byte): Reserved. MUST be 0x18.

eptg (1 byte): Reserved. MUST be 0x06.

loc (4 bytes): An [RgceElfLoc](#) that specifies the location of the label.

2.5.198.56 PtgEq

The **PtgEq** structure specifies the comparison of whether the first [expression](#) is equal to the second expression.

0	1	2	3	4	5	6	7	8	9	10	11	12	13	14	15	16	17	18	19	20	1	2	3	4	5	6	7	8	9	30	1
ptg							A																								

ptg (7 bits): Reserved. MUST be 0x0B.

A - reserved0 (1 bit): MUST be zero, and MUST be ignored.

2.5.198.57 PtgErr

The **PtgErr operand** specifies an error code.

0	1	2	3	4	5	6	7	8	9	10	11	12	13	14	15	16	17	18	19	20	1	2	3	4	5	6	7	8	9	30	1
ptg							A	err																							

ptg (7 bits): Reserved. MUST be 0x1C.

A - reserved0 (1 bit): MUST be zero, and MUST be ignored.

err (1 byte): A [BErr](#) that specifies the error code.

2.5.198.58 PtgExp

The **PtgExp** structure specifies that the containing [Rgce](#) is part of an array formula (section [2.2.2](#)) or shared formula and specifies the row and column of the **cell** in which that formula exists.

The **row** and **col** fields of this structure specify a cell on the current **sheet**. There MUST be a [Formula](#) record where the **cell.row** field of that record is equal to **row**, and **cell.col.col** field of that record is equal to **col**.

That Formula record MUST be followed by either a [ShrFmla](#) record or an [Array](#) record.

If that Formula record is followed by a ShrFmla, the **row** field of this structure MUST be greater than or equal to the **ref.rwFirst** field and less than or equal to the **ref.rwLast** field of the ShrFmla record, and the **col** field of this structure MUST be greater than or equal to the **ref.colFirst** field and less than or equal to the **ref.colLast** field of the ShrFmla record.

If that Formula record is followed by an Array, the **row** field of this structure MUST be equal to the **ref.rwFirst** field of the Array record, and the **col** field of this structure MUST be equal to the **ref.colFirst** field of the Array record.

0	1	2	3	4	5	6	7	8	9	10	1	2	3	4	5	6	7	8	9	20	1	2	3	4	5	6	7	8	9	30	1	
ptg							A	row													col											
...																																

ptg (7 bits): Reserved. MUST be 0x01.

A - reserved0 (1 bit): MUST be zero, and MUST be ignored.

row (2 bytes): A [Rw](#) that specifies the row of the cell that contains the array formula or shared formula that the containing Rgce is a part of.

col (2 bytes): A [Col](#) that specifies the column of the cell that contains the array formula or shared formula that the containing Rgce is a part of.

2.5.198.59 PtgExtraArray

The **PtgExtraArray** structure specifies the values for the corresponding [PtgArray](#) as specified in [RgbExtra](#).

0	1	2	3	4	5	6	7	8	9	10	1	2	3	4	5	6	7	8	9	20	1	2	3	4	5	6	7	8	9	30	1	
cols							rows													array (variable)												
...																																

cols (1 byte): A [DColByteU](#) that specifies one less than the number of columns in the array.

rows (2 bytes): A [DRw](#) that specifies one less than the number of rows in the array.

array (variable): An array of [SerAr](#) that specifies the values in row-major order. The number of elements MUST be equal to the product of **rows** and **cols**.

2.5.198.60 PtgExtraElf

The **PtgExtraElf** structure specifies a multiple-cell **natural language label** used in a **natural language formula**. The label is specified by a sequence of labels from the given array of **cells**.

0	1	2	3	4	5	6	7	8	9	10	1	2	3	4	5	6	7	8	9	20	1	2	3	4	5	6	7	8	9	30	1
count																													A	B	

array (variable)
...

count (30 bits): An unsigned integer that specifies the number of elements in **array**. MUST be greater than 0.

A - reserved (1 bit): MUST be zero, and MUST be ignored

B - fRel (1 bit): A bit that specifies whether **relative references** are used in the elements of **array**.

array (variable): An array of [RqceElfLocExtra](#) elements that specifies the sequence of **cell references** that specifies the multiple-cell natural language label. The number of elements MUST be equal to **count**.

2.5.198.61 PtgExtraMem

The **PtgExtraMem** structure specifies a **range** that corresponds to a [PtgMemArea](#) as specified in [RgbExtra](#).

0	1	2	3	4	5	6	7	8	9	10	11	12	13	14	15	16	17	18	19	20	21	22	23	24	25	26	27	28	29	30	31
count															array (variable)																
...																															

count (2 bytes): An unsigned integer that specifies the areas within the range.

array (variable): An array of [Ref8U](#) that specifies the range. The number of elements MUST be equal to **count**.

2.5.198.62 PtgFunc

The **PtgFunc** structure specifies a call to a function with a fixed number of parameters, as defined in [function-call](#).

0	1	2	3	4	5	6	7	8	9	10	11	12	13	14	15	16	17	18	19	20	21	22	23	24	25	26	27	28	29	30	31
ptg					A		B	iftab																							

ptg (5 bits): Reserved. MUST be 0x01.

A - type (2 bits): A [PtgDataType](#) that specifies the data type for the value of this Ptg.

B - reserved (1 bit): MUST be zero, and MUST be ignored.

iftab (2 bytes): A [Ftab](#) that specifies the function to be called. MUST specify a function with a fixed number of parameters.

2.5.198.63 PtgFuncVar

The **PtgFuncVar** structure specifies a call to a function with a variable number of parameters as defined in [function-call](#).

0	1	2	3	4	5	6	7	8	9	10	11	12	13	14	15	16	17	18	19	20	21	22	23	24	25	26	27	28	29	30	31
ptg					A		B	cparams								tab										C					

ptg (5 bits): Reserved. MUST be 0x02

A - type (2 bits): A [PtgDataType](#) that specifies the data type for the value of this [Ptg](#).

B - reserved (1 bit): MUST be 0, MUST be ignored.

cparams (1 byte): An unsigned integer that specifies the number of parameters. MUST be within the range defined for the function specified by **tab**.

tab (15 bits): A structure that specifies the function to be called. If **fCeFunc** is 1, then this field specifies a [Cetab](#) value. If **fCeFunc** is 0, then this field specifies a [Ftab](#) value.

C - fCeFunc (1 bit): A bit that specifies whether **tab** specifies a **Cetab** value or a **Ftab** value.

2.5.198.64 PtgGe

The **PtgGe** structure specifies a [binary-value-operator](#) that compares whether the first expression in a binary-value-expression is greater than or equal to the second.

0	1	2	3	4	5	6	7	8	9	10	11	12	13	14	15	16	17	18	19	20	21	22	23	24	25	26	27	28	29	30	31
ptg							A																								

ptg (7 bits): Reserved. MUST be 0x0C.

A - reserved0 (1 bit): MUST be zero, and MUST be ignored.

2.5.198.65 PtgGt

The **PtgGt** structure specifies a [binary-value-operator](#) that compares whether the first expression in a binary-value-expression is greater than the second.

0	1	2	3	4	5	6	7	8	9	10	11	12	13	14	15	16	17	18	19	20	21	22	23	24	25	26	27	28	29	30	31
ptg							A																								

ptg (7 bits): Reserved. MUST be 0x0D.

A - reserved0 (1 bit): MUST be zero, and MUST be ignored.

2.5.198.66 PtgInt

The **PtgInt** [operand](#) specifies an unsigned integer value.

0	1	2	3	4	5	6	7	8	9	10	11	12	13	14	15	16	17	18	19	20	21	22	23	24	25	26	27	28	29	30	31
ptg							A	integer																							

ptg (7 bits): Reserved. MUST be 0x1E.

A - reserved0 (1 bit): MUST be zero, and MUST be ignored.

integer (2 bytes): An unsigned integer that specifies the value.

2.5.198.67 PtgIsect

The **PtgIsect** structure specifies a [binary-reference-operator](#) that intersects the first expression in a binary-reference-expression with the second.

0	1	2	3	4	5	6	7	8	9	10	11	12	13	14	15	16	17	18	19	20	1	2	3	4	5	6	7	8	9	30	1
ptg																A															

ptg (7 bits): Reserved. MUST be 0x0F.

A - reserved0 (1 bit): MUST be zero, and MUST be ignored.

2.5.198.68 PtgLe

The **PtgLe** structure specifies a [binary-value-operator](#) that compares whether the first expression in a binary-value-expression is less than or equal to the second.

0	1	2	3	4	5	6	7	8	9	10	11	12	13	14	15	16	17	18	19	20	1	2	3	4	5	6	7	8	9	30	1
ptg																A															

ptg (7 bits): Reserved. MUST be 0x0A.

A - reserved0 (1 bit): MUST be zero, and MUST be ignored.

2.5.198.69 PtgLt

The **PtgLt** structure specifies a [binary-value-operator](#) that compares whether the first expression in a binary-value-expression is less than the second.

0	1	2	3	4	5	6	7	8	9	10	11	12	13	14	15	16	17	18	19	20	1	2	3	4	5	6	7	8	9	30	1
ptg																A															

ptg (7 bits): Reserved. MUST be 0x09.

A - reserved0 (1 bit): MUST be zero, and MUST be ignored.

2.5.198.70 PtgMemArea

The **PtgMemArea** [mem token](#) specifies that the result of a [binary-reference-expression](#) in a mem-area-expression is a **range of cells**. The [RgbExtra](#) corresponding to this structure MUST contain a [PtgExtraMem](#) that specifies the range of cells.

0	1	2	3	4	5	6	7	8	9	10	11	12	13	14	15	16	17	18	19	20	21	22	23	24	25	26	27	28	29	30	31					
ptg					A		B	unused																												
...							cce																													

ptg (5 bits): Reserved. MUST be 0x06.

A - type (2 bits): A [PtgDataType](#) that specifies the data type for the value of this [Ptg](#).

B - reserved (1 bit): MUST be zero, and MUST be ignored.

unused (4 bytes): Undefined and MUST be ignored.

cce (2 bytes): An unsigned integer that specifies the count of bytes in the binary-reference-expression following this structure.

2.5.198.71 PtgMemErr

The **PtgMemErr** [mem token](#) specifies that the result of a [binary-reference-expression](#) in a mem-area-expression is an error code.

0	1	2	3	4	5	6	7	8	9	10	11	12	13	14	15	16	17	18	19	20	21	22	23	24	25	26	27	28	29	30	31				
ptg					A		B	err							unused1							unused2													
...							cce																												

ptg (5 bits): Reserved. MUST be 0x07.

A - type (2 bits): A [PtgDataType](#) that specifies the data type for the value of this Ptg.

B - reserved (1 bit): MUST be zero, and MUST be ignored.

err (1 byte): A [BErr](#) that specifies the error code value.

unused1 (1 byte): Undefined and MUST be ignored.

unused2 (2 bytes): Undefined and MUST be ignored.

cce (2 bytes): An unsigned integer that specifies the count of bytes in the binary-reference-expression following this structure.

2.5.198.72 PtgMemFunc

The **PtgMemFunc** [mem token](#) specifies that the result of a [binary-reference-expression](#) in a mem-area-expression is variable.

0	1	2	3	4	5	6	7	8	9	10	11	12	13	14	15	16	17	18	19	20	21	22	23	24	25	26	27	28	29	30	31					
ptg					A		B	cce																												

ptg (5 bits): Reserved. MUST be 0x09.

A - type (2 bits): A [PtgDataType](#) that specifies the data type for the value of this Ptg.

B - reserved (1 bit): MUST be zero, and MUST be ignored.

cce (2 bytes): An unsigned integer that specifies the count of bytes in the binary-reference-expression following this structure.

2.5.198.73 PtgMemNoMem

The **PtgMemNoMem** [mem token](#) specifies that the result of the [binary-reference-expression](#) in a mem-area-expression failed to cache.

0	1	2	3	4	5	6	7	8	9	10	11	12	13	14	15	16	17	18	19	20	21	22	23	24	25	26	27	28	29	30	31					
ptg					A		B	unused																												
...								cce																												

ptg (5 bits): Reserved. MUST be 0x08.

A - type (2 bits): A [PtgDataType](#) that specifies the data type for the value of this [Ptg](#).

B - reserved (1 bit): MUST be zero, and MUST be ignored.

unused (4 bytes): Undefined and MUST be ignored.

cce (2 bytes): An unsigned integer that specifies the count of bytes in the binary-reference-expression following this structure.

2.5.198.74 PtgMissArg

The **PtgMissArg** [operand](#) specifies a missing value.

0	1	2	3	4	5	6	7	8	9	10	11	12	13	14	15	16	17	18	19	20	21	22	23	24	25	26	27	28	29	30	31
ptg							A																								

ptg (7 bits): Reserved. MUST be 0x16.

A - reserved0 (1 bit): MUST be zero, and MUST be ignored.

2.5.198.75 PtgMul

The **PtgMul** structure specifies a [binary-value-operator](#) that multiplies the first and second expressions in a binary-value-expression.

0	1	2	3	4	5	6	7	8	9	10	11	12	13	14	15	16	17	18	19	20	21	22	23	24	25	26	27	28	29	30	31
ptg							A																								

ptg (7 bits): Reserved. MUST be 0x05.

A - reserved0 (1 bit): MUST be zero, and MUST be ignored.

2.5.198.76 PtgName

The **PtgName** [operand](#) specifies a reference to a **defined name** in the same **workbook** as the containing Rgce.

If the formula (section [2.2.2](#)) containing this structure is part of a revision as specified in the Formulas overview, then there MUST be a [RevNameTabId](#) in the [RgbExtra](#) corresponding to this PtgName, which specifies those defined name.

0	1	2	3	4	5	6	7	8	9	10	11	12	13	14	15	16	17	18	19	20	21	22	23	24	25	26	27	28	29	30	31					
ptg					A		B	nameindex																												
...																																				

ptg (5 bits): Reserved. MUST be 0x03.

A - type (2 bits): A [PtgDataType](#) that specifies the required data type for the value of the [Ptg](#).

B - reserved (1 bit): MUST be zero, and MUST be ignored.

nameindex (4 bytes): If the formula containing this structure is part of a revision as specified in the Formulas overview, then this value is undefined and MUST be ignored. Otherwise it is an unsigned integer that specifies a one-based index of a [Lbl](#) record in the collection of Lbl records in the [Globals Substream](#). The referenced Lbl specifies the referenced defined name. MUST be greater than 0 and less than or equal to the number of Lbl records in the workbook.

2.5.198.77 PtgNameX

The **PtgNameX** structure specifies a reference to a **defined name** in an [external workbook](#).

If the formula (section [2.2.2](#)) containing this structure is part of a revision as specified in the Formulas overview, then there MUST be a [RevName](#) in the [RgbExtra](#) corresponding to this PtgNameX that specifies the defined name.

If the formula containing this structure is not part of a revision as specified in the Formulas overview (section [2.2.2](#)), then the referenced defined name is specified by an [XtiIndex](#).

0	1	2	3	4	5	6	7	8	9	10	11	12	13	14	15	16	17	18	19	20	21	22	23	24	25	26	27	28	29	30	31
ptg					A		B	ixti														nameindex									
...																															

ptg (5 bits): Reserved. MUST be 0x19.

A - type (2 bits): A [PtgDataType](#) that specifies the required data type for the value of the Ptg.

B - reserved (1 bit): MUST be zero, and MUST be ignored.

ixti (2 bytes): If the formula containing this structure is not part of a revision as specified in the Formulas overview, this value is an XtiIndex that specifies the [XTI](#) that specifies the referenced defined name.

If the formula containing this structure is part of a revision as specified in the Formulas overview, this value is undefined and MUST be ignored.

nameindex (4 bytes): If the formula containing this structure is not part of a revision as specified in the Formulas overview, this value is an unsigned integer that specifies the one-based index of an [ExternName](#) record in the collection of ExternName records directly following the [SupBook](#) record referenced by **ixti**. The referenced ExternName and its associated records specify the referenced defined name.

If the formula containing this structure is part of a revision as specified in the Formulas overview, this value is undefined and MUST be ignored.

2.5.198.78 PtgNe

The **PtgNe** structure specifies a [binary-value-operator](#) that compares whether the second expression in a binary-value-expression is not equal to the first.

0	1	2	3	4	5	6	7	8	9	10	11	12	13	14	15	16	17	18	19	20	1	2	3	4	5	6	7	8	9	30	1
ptg															A																

ptg (7 bits): Reserved. MUST be 0x0E.

A - reserved0 (1 bit): MUST be zero, and MUST be ignored.

2.5.198.79 PtgNum

The **PtgNum** [operand](#) specifies a floating-point value.

0	1	2	3	4	5	6	7	8	9	10	11	12	13	14	15	16	17	18	19	20	1	2	3	4	5	6	7	8	9	30	1
ptg															A	value															
...																															
...																															

ptg (7 bits): Reserved. MUST be 0x1F

A - reserved0 (1 bit): MUST be zero, and MUST be ignored.

value (8 bytes): An Xnum (section [2.5.342](#)) that specifies the floating-point value.

2.5.198.80 PtgParen

The **PtgParen** [display token](#) specifies that parentheses are displayed around the expression in a [display-precedence-expression](#).

0	1	2	3	4	5	6	7	8	9	10	11	12	13	14	15	16	17	18	19	20	1	2	3	4	5	6	7	8	9	30	1
ptg															A																

ptg (7 bits): Reserved. MUST be 0x15.

A - reserved0 (1 bit): MUST be zero, and MUST be ignored.

2.5.198.81 PtgPercent

The **PtgPercent** structure specifies a [unary-operator](#) which divides the expression in a unary-expression by 100.

0	1	2	3	4	5	6	7	8	9	10	11	12	13	14	15	16	17	18	19	20	21	22	23	24	25	26	27	28	29	30	31
ptg																A															

ptg (7 bits): Reserved. MUST be 0x14.

A - reserved0 (1 bit): MUST be zero, and MUST be ignored.

2.5.198.82 PtgPower

The **PtgPower** structure specifies a [binary-value-operator](#) that raises the first expression in a binary-value-expression to the power of the second.

0	1	2	3	4	5	6	7	8	9	10	11	12	13	14	15	16	17	18	19	20	21	22	23	24	25	26	27	28	29	30	31
ptg																A															

ptg (7 bits): Reserved. MUST be 0x07.

A - reserved0 (1 bit): MUST be zero, and MUST be ignored.

2.5.198.83 PtgRange

The **PtgRange** structure specifies the range operation, where the minimum bounding rectangle of the first [expression](#) and the second expression is generated.

0	1	2	3	4	5	6	7	8	9	10	11	12	13	14	15	16	17	18	19	20	21	22	23	24	25	26	27	28	29	30	31
ptg																A															

ptg (7 bits): Reserved. MUST be 0x11.

A - reserved0 (1 bit): MUST be zero, and MUST be ignored.

2.5.198.84 PtgRef

The **PtgRef** [operand](#) specifies a reference to a single **cell** as an [RcfcLoc](#).

0	1	2	3	4	5	6	7	8	9	10	11	12	13	14	15	16	17	18	19	20	21	22	23	24	25	26	27	28	29	30	31
ptg						A	B	loc																							

...

ptg (5 bits): Reserved. MUST be 0x04.

A - type (2 bits): A [PtgDataType](#) that specifies the data type for the value of this [Ptg](#).

B - reserved (1 bit): MUST be zero, and MUST be ignored.

loc (4 bytes): A [RgceLoc](#) value that specifies the coordinates of the referenced cell.

2.5.198.85 PtgRef3d

The **PtgRef3d operand** specifies a reference to a single **cell** on one or more **sheets**.

If the formula (section [2.2.2](#)) containing this structure is part of a revision as specified in the Formulas overview (section 2.2.2), then there MUST be a [RevExtern](#) in the [RgcbExtra](#) corresponding to this PtgRef3d, which specifies those sheets.

0	1	2	3	4	5	6	7	8	9	10	11	12	13	14	15	16	17	18	19	20	21	22	23	24	25	26	27	28	29	30	31
ptg					A	B	ixti															loc									
...																															

ptg (5 bits): Reserved. MUST be 0x1A.

A - type (2 bits): A [PtgDataType](#) that specifies the required data type for the value of the Ptg.

B - reserved (1 bit): MUST be zero, and MUST be ignored.

ixti (2 bytes): If the formula containing this structure is not part of a revision as specified in the Formulas overview, then this value is an [XtiIndex](#) that specifies the [XTI](#) which specifies those sheets. Otherwise it is undefined and MUST be ignored.

loc (4 bytes): A value that specifies coordinates of the referenced cell. If this PtgRef3d is part of a [NameParsedFormula](#) then this is a [RgceLocRel](#) value. Otherwise it is a [RgceLoc](#) value.

2.5.198.86 PtgRefErr

The **PtgRefErr operand** specifies an invalid reference to a **cell**.

0	1	2	3	4	5	6	7	8	9	10	11	12	13	14	15	16	17	18	19	20	21	22	23	24	25	26	27	28	29	30	31
ptg					A	B	unused1															unused2									
...																															

ptg (5 bits): Reserved. MUST be 0x0A.

A - type (2 bits): A [PtgDataType](#) that specifies the data type for the value of this [Ptg](#).

B - reserved (1 bit): MUST be zero, and MUST be ignored.

unused1 (2 bytes): Undefined and MUST be ignored.

unused2 (2 bytes): Undefined and MUST be ignored.

2.5.198.87 PtgRefErr3d

The **PtgRefErr3d operand** specifies an invalid reference to a **cell** on one or more **sheets**. If the formula (section 2.2.2) containing this structure is part of a revision as specified in the Formulas overview (section 2.2.2), then there MUST be a **RevExtern** in the **RgbExtra** corresponding to this PtgRefErr3d, which specifies those sheets.

0	1	2	3	4	5	6	7	8	9	10	11	12	13	14	15	16	17	18	19	20	21	22	23	24	25	26	27	28	29	30	31
ptg					A	B	ixti															unused1									
...						unused2																									

ptg (5 bits): Reserved. MUST be 0x1C.

A - type (2 bits): A [PtgDataType](#) that specifies the required data type for the value of the Ptg.

B - reserved (1 bit): MUST be zero, and MUST be ignored.

ixti (2 bytes): If the formula containing this structure is not part of a revision as specified in the Formulas overview (section 2.2.2), then this value is an [XtiIndex](#) that specifies the **XTI** which specifies those sheets. Otherwise it is undefined and MUST be ignored.

unused1 (2 bytes): Undefined and MUST be ignored.

unused2 (2 bytes): Undefined and MUST be ignored.

2.5.198.88 PtgRefN

The **PtgRefN operand** specifies a reference to a single **cell** as an [RgceLocRel](#).

0	1	2	3	4	5	6	7	8	9	10	11	12	13	14	15	16	17	18	19	20	21	22	23	24	25	26	27	28	29	30	31
ptg					A	B	loc																								
...																															

ptg (5 bits): Reserved. MUST be 0x0C.

A - type (2 bits): A [PtgDataType](#) that specifies the data type for the value of this Ptg.

B - reserved (1 bit): MUST be zero, and MUST be ignored.

loc (4 bytes): An [RgceLocRel](#) that specifies the referenced cell.

2.5.198.89 PtgStr

The **PtgStr operand** specifies a **Unicode** string value.

0	1	2	3	4	5	6	7	8	9	10	11	12	13	14	15	16	17	18	19	20	21	22	23	24	25	26	27	28	29	30	31
ptg							A	string (variable)																							
...																															

ptg (7 bits): Reserved. MUST be 0x17.

A - reserved0 (1 bit): MUST be zero, and MUST be ignored.

string (variable): A [ShortXLUnicodeString](#) value that specifies the string.

2.5.198.90 PtgSub

The **PtgSub** structure specifies a [binary-value operator](#) that subtracts the second expression in a binary-value-expression from the first.

0	1	2	3	4	5	6	7	8	9	10	11	12	13	14	15	16	17	18	19	20	21	22	23	24	25	26	27	28	29	30	31
ptg							A																								

ptg (7 bits): Reserved. MUST be 0x04.

A - reserved0 (1 bit): MUST be zero, and MUST be ignored.

2.5.198.91 PtgSxName

The **PtgSxName** structure specifies a reference to a [calculated field](#) or a [calculated item](#) found in a [PivotParsedFormula](#). The [Rqce](#) that contains this Ptg MUST be part of the **formula** field of an [SxFmla](#) record.

0	1	2	3	4	5	6	7	8	9	10	11	12	13	14	15	16	17	18	19	20	21	22	23	24	25	26	27	28	29	30	31
ptg							A	eptg					sxIndex																		
...																															

ptg (7 bits): Reserved. MUST be 0x18.

A - reserved0 (1 bit): MUST be zero, and MUST be ignored.

eptg (1 byte): Reserved. MUST be 0x1D.

sxIndex (4 bytes): An unsigned integer that specifies the zero-based index of an [SxName](#) record in the collection of SxName records following an SxFmla record. MUST be less than the value of **formula.cSxName** in the SxFmla record.

2.5.198.92 PtgTbl

The **PtgTbl** structure specifies that the [Rqce](#) that contains this PtgTbl is part of a **data table (1)** or an [ObjectParsedFormula](#).

If the Rgce is not part of an ObjectParsedFormula, then there MUST be a [Table](#) record in the current part where the **ref.rwFirst** field in Table is equal to **row** and the **ref.colFirst** field in Table is equal to **col**.

0	1	2	3	4	5	6	7	8	9	10	11	12	13	14	15	16	17	18	19	20	21	22	23	24	25	26	27	28	29	30	31
ptg							A	row														col									
...																															

ptg (7 bits): Reserved. MUST be 0x02

A - reserved0 (1 bit): MUST be zero, and MUST be ignored.

row (2 bytes): An unsigned integer that specifies the first row of the data table (1). MUST be less than 65536. If the Rgce that contains this PtgTbl is part of an ObjectParsedFormula, this field is undefined and MUST be ignored.

col (2 bytes): An unsigned integer that specifies the first column of the data table (1). MUST be less than 256. If the Rgce that contains this PtgTbl is part of an ObjectParsedFormula, this field is undefined and MUST be ignored.

2.5.198.93 PtgUminus

The **PtgUminus** structure specifies a [unary-operator](#) which generates the additive inverse of a unary-expression.

0	1	2	3	4	5	6	7	8	9	10	11	12	13	14	15	16	17	18	19	20	21	22	23	24	25	26	27	28	29	30	31
ptg							A																								

ptg (7 bits): Reserved. MUST be 0x13.

A - reserved0 (1 bit): MUST be zero, and MUST be ignored.

2.5.198.94 PtgUnion

The **PtgUnion** structure specifies a [binary-reference-operator](#) that specifies a union of the first expression in a binary-reference-expression with the second.

0	1	2	3	4	5	6	7	8	9	10	11	12	13	14	15	16	17	18	19	20	21	22	23	24	25	26	27	28	29	30	31
ptg							A																								

ptg (7 bits): Reserved. MUST be 0x10.

A - reserved0 (1 bit): MUST be zero, and MUST be ignored.

2.5.198.95 PtgUplus

The **PtgUplus** structure specifies a [unary-operator](#) which leaves a unary-expression unchanged.

0	1	2	3	4	5	6	7	8	9	10	11	12	13	14	15	16	17	18	19	20	21	22	23	24	25	26	27	28	29	30	31
ptg										A																					

ptg (7 bits): Reserved. MUST be 0x12.

A - reserved0 (1 bit): MUST be zero, and MUST be ignored.

2.5.198.96 RevExtern

The **RevExtern** structure specifies a **range** of **sheets** on a **workbook** that is referenced by a formula (section 2.2.2) in a revision as specified in the Formulas overview (section 2.2.2).

0	1	2	3	4	5	6	7	8	9	10	11	12	13	14	15	16	17	18	19	20	21	22	23	24	25	26	27	28	29	30	31
book (variable)																															
...																															
itabFirst (variable)																															
...																															
itabLast (variable)																															
...																															

book (variable): Specifies the workbook based on the value of the first byte, according to the following table:

Value	Meaning
0x01	Specifies the current workbook. This field is two bytes in size. The second byte MUST be 0x02.
Any value except 0x01	This field is a VirtualPath that specifies the workbook.

itabFirst (variable): A [RevItab](#) that specifies the first sheet in the range.

itabLast (variable): A [RevItab](#) that specifies the last sheet in the range.

2.5.198.97 RevItab

The **RevItab** structure specifies a **sheet** of a **workbook** referenced by a formula (section 2.2.2) in a revision as specified in the Formulas overview (section 2.2.2).

0	1	2	3	4	5	6	7	8	9	10	11	12	13	14	15	16	17	18	19	20	21	22	23	24	25	26	27	28	29	30	31
type										tabid (optional)											sheet (variable)										
...																															

type (1 byte): An unsigned integer that specifies the sheet. MUST be a value from the following table:

Value	Meaning
0x00	Specifies a sheet on the same workbook. The tabid field specifies the sheet.
0x01	Specifies a sheet on a different workbook. The sheet field specifies the sheet.
0x02	Specifies the same sheet specified by the preceding RevItab.
0x03	Specifies a missing sheet.

tabid (2 bytes): An unsigned integer that specifies a sheet identifier in the current workbook. MUST match a sheet identifier specified by [RRTabId](#). This field MUST be present if and only if **type** is 0x00.

sheet (variable): A [XLUnicodeString](#) that specifies the sheet name. This field MUST be present if and only if **type** is 0x01.

2.5.198.98 RevLblName

The **RevLblName** structure specifies the name of a **defined name** that is referenced by a formula in a revision as specified in the Formulas overview (section [2.2.2](#)).

0	1	2	3	4	5	6	7	8	9	10	11	12	13	14	15	16	17	18	19	20	21	22	23	24	25	26	27	28	29	30	31
iBuiltin										st (variable)																					
...																															

iBuiltin (1 byte): An unsigned integer that specifies whether the defined name is a **built-in name**, and if so, which built-in name it is. The value MUST be from the following table:

Value	Meaning
0x00	This is not a built-in name.
0x01	Consolidate_Area
0x02	Auto_Open
0x03	Auto_Close
0x04	Extract
0x05	Database
0x06	Criteria
0x07	Print_Area
0x08	Print_Titles

Value	Meaning
0x09	Recorder
0x0A	Data_Form
0x0B	Auto_Activate
0x0C	Auto_Deactivate
0x0D	Sheet_Title
0x0E	_FilterDatabase

st (variable): If **iBuiltin** is 0x00, then **st** is an [XLNameUnicodeString](#) that specifies the name of the defined name. Otherwise, **st** is an [XLUnicodeString](#) and the name of the defined name is specified as the concatenation of built-in name specified by **iBuiltin** and **st**. The concatenated string **MUST** match grammar specified for [XLNameUnicodeString](#).

2.5.198.99 RevName

The **RevName** structure specifies a **defined name** referenced by a formula (section [2.2.2](#)) in a revision as specified in the Formulas overview (section [2.2.2](#)).

0	1	2	3	4	5	6	7	8	9	10	11	12	13	14	15	16	17	18	19	20	21	22	23	24	25	26	27	28	29	30	31
book (variable)																															
...																															
fExtern										name (variable)																					
...																															
externName (variable)																															
...																															

book (variable): Specifies the **workbook** based on the value of the first byte, according to the following table:

Value	Meaning
0x01	Specifies the current workbook. This field is two bytes in size. The second byte MUST be 0x02.
Any value except 0x01	This field is a VirtualPath that specifies the workbook.

fExtern (1 byte): A Boolean (section [2.5.14](#)) that specifies whether the defined name is defined in the current workbook. **MUST** be 0x00 if the first byte of **book** is 0x01, and 0x01 otherwise.

name (variable): A [RevNameTabId](#) that specifies the name and the scope of the defined name. This field **MUST** be present if and only if **fExtern** is 0x00.

externName (variable): A [RevNamePly](#) that specifies the name and the scope of the defined name. This field **MUST** be present if and only if **fExtern** is 0x01.

2.5.198.100 RevNamePly

The **RevNamePly** structure specifies a **defined name** in an [external workbook](#) that is referenced by a formula (section [2.2.2](#)) in a revision as specified in the Formulas overview (section 2.2.2), and the **sheet** on which it is defined.

0	1	2	3	4	5	6	7	8	9	10	1	2	3	4	5	6	7	8	9	20	1	2	3	4	5	6	7	8	9	30	1		
sheet (variable)																																	
...																																	
name (variable)																																	
...																																	

sheet (variable): A [RevSheetName](#) that specifies the sheet on which the defined name is defined.

name (variable): A [RevLblName](#) that specifies the defined name.

2.5.198.101 RevNameTabId

The **RevNameTabId** structure specifies a non-external **defined name** that is referenced by a formula (section [2.2.2](#)) in a revision as specified in the Formulas overview (section 2.2.2).

0	1	2	3	4	5	6	7	8	9	10	1	2	3	4	5	6	7	8	9	20	1	2	3	4	5	6	7	8	9	30	1		
tabid											name (variable)																						
...																																	

tabid (2 bytes): An unsigned integer that specifies the scope of the defined name. The value MUST be from the following table:

Value	Meaning
0xFFFF	Specifies that the scope is the entire workbook .
Greater than or equal to 1 and less than 0xFFFF	Specifies that the scope is a sheet from the workbook. The value is a sheet identifier which MUST match a sheet identifier specified by RRTabId in the Globals Substream .

name (variable): A [RevLblName](#) that specifies the name of the defined name.

2.5.198.102 RevSheetName

The **RevSheetName** structure specifies the **sheet** or **workbook** on which a **defined name** is defined, for a defined name that is referenced by a formula (section [2.2.2](#)) in a revision as specified in the Formulas overview (section 2.2.2).

0	1	2	3	4	5	6	7	8	9	10	11	12	13	14	15	16	17	18	19	20	21	22	23	24	25	26	27	28	29	30	31
sheet (variable)																															
...																															

sheet (variable): A [XLUnicodeString](#) that specifies the name of the sheet. The length of the string MUST be less than or equal to 31 characters. This field specifies the entire workbook if the length of the string is zero.

2.5.198.103 RgbExtra

The **RgbExtra** structure specifies a set of structures, laid out sequentially in the file, that correspond to and MUST exist for certain PtgS in the [Rgce](#). The order of the structures MUST be the same as the order of the PtgS in the Rgce that they correspond to.

The following PtgS MUST have a corresponding structure in an RgbExtra.

Ptg	Required structure in an RgbExtra
PtgArray	PtgExtraArray
PtgMemArea	PtgExtraMem
PtgElfRadicalS	PtgExtraElf
PtgElfColS	PtgExtraElf
PtgElfColSV	PtgExtraElf

The following PtgS MUST have a corresponding structure in an RgbExtra if and only if the formula (section [2.2.2](#)) containing that Ptg is part of a revision as specified in the Formulas overview (section [2.2.2](#)).

Ptg	Required structure in an RgbExtra
PtgName	RevNameTabId
PtgNameX	RevName
PtgRef3d	RevExtern
PtgRefErr3d	RevExtern
PtgArea3d	RevExtern
PtgAreaErr3d	RevExtern

0	1	2	3	4	5	6	7	8	9	10	11	12	13	14	15	16	17	18	19	20	21	22	23	24	25	26	27	28	29	30	31
rgb (variable)																															
...																															

rgb (variable): An array that contains the sequence of these structures.

2.5.198.104 Rgce

The **Rgce** structure specifies a set of [Ptgs](#), laid out sequentially in the file.

The sequence of Ptgs MUST adhere to the following grammar.

EXPRESSION_SIZE is the sum of the sizes of a contiguous set of Ptgs in bytes.

The ACTUAL_PTG_SIZE of a Ptg is as follows:

Ptg	ACTUAL_PTG_SIZE
PtgStr	1 + (stringsize + 1) * 2 where stringsize is the string.cch field of the PtgStr structure
PtgArray	15
PtgRef	7
PtgArea	13
PtgRefErr	7
PtgAreaErr	13
PtgRefN	7
PtgAreaN	13
PtgRef3d	9
PtgArea3d	15
PtgRefErr3d	9
PtgAreaErr3d	16
Any other Ptg	Size of the Ptg in bytes

The ACTUAL_EXPRESSION_SIZE of a contiguous set of Ptgs is the sum of ACTUAL_PTG_SIZEs of those Ptgs. The ACTUAL_EXPRESSION_SIZE of all Ptgs in an Rgce MUST be less than or equal to 1800.

rgce = [PtgExp](#) / [PtgTbl](#) / [[PtgAttrBaxcel](#) / [PtgAttrSemi](#) / [PtgAttrSpaceSemi](#)] expression

expression = *[PtgAttrSpace](#) base-expression

The value of the **type** field of each PtgAttrSpace in an expression MUST be 0, 1, or 6.

base-expression = operand / unary-expression / binary-reference-expression / binary-value-expression / display-precedence-specifier / mem-area-expression / function-call

operand = [PtgMissArg](#) / [PtgStr](#) / [PtgErr](#) / [PtgBool](#) / [PtgInt](#) / [PtgNum](#) / [PtgArray](#) / [PtgName](#) / [PtgRef](#) / [PtgArea](#) / [PtgRefErr](#) / [PtgAreaErr](#) / [PtgRefN](#) / [PtgAreaN](#) / [PtgNameX](#) / [PtgRef3d](#) / [PtgArea3d](#) / [PtgRefErr3d](#) / [PtgAreaErr3d](#) / [PtgElfLel](#) / [PtgElfRw](#) / [PtgElfCol](#) / [PtgElfRwV](#) / [PtgElfColV](#) / [PtgElfRadical](#) / [PtgArea](#) / [PtgElfRadical](#) / [PtgAreaErr](#) / [PtgElfRadicals](#) / [PtgArea](#) / [PtgElfRadicals](#) / [PtgAreaErr](#) / [PtgElfColS](#) / [PtgElfColSV](#) / [PtgElfRadicalLel](#) / [PtgArea](#) / [PtgElfRadicalLel](#) / [PtgAreaErr](#) / [PtgSxName](#)

Each Ptg in this definition is an [operand token](#).

unary-expression = val unary-operator

unary-operator = [PtgUplus](#) / [PtgUminus](#) / [PtgPercent](#)

Each Ptg in this definition is an [operator token](#).

binary-reference-expression = 2ref binary-reference-operator

binary-reference-operator = [PtgIsect](#) / [PtgUnion](#) / [PtgRange](#)

Each Ptg in this definition is an operator token.

binary-value-expression = 2val binary-value-operator

binary-value-operator = [PtgAdd](#) / [PtgSub](#) / [PtgMul](#) / [PtgDiv](#) / [PtgPower](#) / [PtgConcat](#) / [PtgLt](#) / [PtgLe](#)
/ [PtgEq](#) / [PtgGe](#) / [PtgGt](#) / [PtgNe](#)

Each Ptg in this definition is an operator token.

display-precedence-specifier = expression [PtgAttrSpace] [PtgParen](#)

The value of the **type** field of a PtgAttrSpace MUST be between 2 and 5 inclusive.

PtgAttrSpace and PtgParen are [display tokens](#).

mem-area-expression = mem-ptg binary-reference-expression

The **cce** field in the Ptg of the mem-ptg rule MUST be equal to the EXPRESSION_SIZE of the PtgS that comprise the binary-reference-expression.

If mem-ptg is not [PtgMemFunc](#) then the expression elements in the binary-reference-expression MUST NOT contain any mem-ptg elements, [PtgFunc](#), [PtgFuncVar](#), PtgName, PtgNameX, PtgRef3d, PtgArea3d, PtgRefErr3d, or PtgAreaErr3d.

mem-ptg = [PtgMemArea](#) / [PtgMemErr](#) / [PtgMemNoMem](#) / PtgMemFunc

Each Ptg in this definition is a [mem token](#).

function-call = if-expression / choose-expression / [[params-fixed](#)] PtgFunc / params-variable
PtgFuncVar / [params-cetab](#) PtgFuncVar / expression [PtgAttrSum](#)

The params-fixed element MUST NOT be specified if PtgFunc specifies a function that takes no parameters. Otherwise, it MUST conform to the ABNF rule for the function specified by PtgFunc.

if-expression = expression [PtgAttrIf](#) 1*2(expression [PtgAttrGoto](#)) PtgFuncVar

The value of the **offset** field in the PtgAttrIf MUST be equal to the EXPRESSION_SIZE of all PtgS in the if-expression after the PtgAttrIf through the first PtgAttrGoto.

The value of the **offset** field in each PtgAttrGoto MUST be equal to one less than the EXPRESSION_SIZE of all PtgS remaining in the if-expression after that PtgAttrGoto.

The value of the **fCeFunc** field of the PtgFuncVar MUST be zero. The value of the **tab** field of the PtgFuncVar MUST be 0x0001, which represents the IF function.

choose-expression = expression [PtgAttrChoose](#) 1*29(expression PtgAttrGoto) PtgFuncVar

The value of the **cOffset** field in the PtgAttrChoose MUST be equal to the number of times the expression in the repeated sequence group appears.

The first offset in the array of offsets in the **rgOffset** field in the PtgAttrChoose MUST be equal to four less than the size of the PtgAttrChoose in bytes.

For the n^{th} occurrence of the repeated sequence group, the $(n+1)^{\text{th}}$ offset in the array of offsets in the **rgOffset** field in the PtgAttrChoose MUST be equal to the `EXPRESSION_SIZE` of all PtgS in the choose-expression after the PtgAttrChoose through the n^{th} PtgAttrGoto.

The value of the **offset** field in each PtgAttrGoto MUST equal one less than the `EXPRESSION_SIZE` of all PtgS remaining in the choose-expression after that PtgAttrGoto.

The value of the **fCeFunc** field of the PtgFuncVar MUST be zero. The value of the **tab** field of the PtgFuncVar MUST be 0x0064, which represents the CHOOSE function.

`val = expression`

Additional restrictions are specified under `VALUE_TYPE`. The `params-fixed`, `params-variable` and `params-cetab` rules also use `val`.

`ref = expression`

Additional restrictions are specified under `VALUE_TYPE`. The `params-fixed`, `params-variable` and `params-cetab` rules also use `ref`.

If the value of the **useselfs** field of the [UsesELFs](#) record is zero then an Rgce MUST NOT contain PtgElfLel, PtgElfRw, PtgElfCol, PtgElfRwV, PtgElfColV, PtgElfRadical, PtgElfRadicalS, PtgElfColS, PtgElfColSV, and PtgElfRadicalLel.

PtgElfLel, PtgElfRw, PtgElfCol, PtgElfRwV, PtgElfColV, PtgElfRadical, PtgElfRadicalS, PtgElfColS, PtgElfColSV, and PtgElfRadicalLel SHOULD NOT [<178>](#) be used.

Additional restrictions on the contents of this structure are specified in terms of a parse tree. For this purpose, a parse tree is a means of organizing the components of an Rgce. Each node in the parse tree represents a Ptg or an ABNF rule described previously. Non-leaf nodes represent rules and have one child node for each element in the rule. Leaf nodes represent only a Ptg.

For a leaf node in the parse tree, `NESTING_DEPTH` is the number of function-call nodes in the path from the root node to that leaf.

For a node in the parse tree, `OPERAND_COUNT` is as follows:

- The `OPERAND_COUNT` of each Ptg appearing in the operand rule definition is one.
- The `OPERAND_COUNT` of all other PtgS is zero.
- The `OPERAND_COUNT` of a node that has n child nodes with nonzero `OPERAND_COUNT` is equal to the maximum, across all the n child nodes, of $(n-1)$ plus the `OPERAND_COUNT` of the n^{th} child that has nonzero `OPERAND_COUNT`.

For a node in the parse tree, `VALUE_TYPE` is a state indicating that the node represents a single value of a simple type or an array of such values. A node that is not a `VALUE_TYPE` represents a reference to a **range**. Elements in an expression MUST represent either values or references, based on the specific PtgS used in the expression. The following rules specify how to traverse the parse tree from the bottom up and determine whether each node is a `VALUE_TYPE`, which determines whether the sequence of PtgS comprising the formula correctly satisfies the requirements of each expression in the formula. A node is determined to be a `VALUE_TYPE` as follows:

- Leaf nodes:
- PtgMissArg, PtgStr, PtgSxName, PtgErr, PtgBool, PtgInt, PtgNum, PtgArray, PtgRefErr, PtgAreaErr, PtgRefErr3d, PtgAreaErr3d, PtgElfLel, PtgElfRwV, PtgElfColV, PtgElfColSV, PtgElfRadicalLel,

PtgUplus, PtgUminus, PtgPercent, PtgAdd, PtgSub, PtgMul, PtgDiv, PtgPower, PtgConcat, PtgLt, PtgLe, PtgEq, PtgGe, PtgGt, and PtgNe leaf nodes are VALUE_TYPES.

- PtgName, PtgRef, PtgArea, PtgRefN, PtgAreaN, PtgNameX, PtgRef3d, PtgArea3d, PtgFunc, PtgFuncVar, PtgMemArea, PtgMemErr, PtgMemNoMem, and PtgMemFunc leaf nodes are VALUE_TYPES if and only if the value of the **type** field is value or array.
- All other leaf nodes are not VALUE_TYPES.
- Non-leaf nodes:
 - Any non-leaf node with a single child node MUST be a VALUE_TYPE if and only if the child node is a VALUE_TYPE.
 - Any non-leaf node with a mem-ptg, unary-operator, binary-value-operator, binary-reference-operator, PtgAttrSum, PtgFunc or PtgFuncVar child node is a VALUE_TYPE if and only if that child node is a VALUE_TYPE. Other child nodes are ignored for the purposes of determining whether the non-leaf node is a VALUE_TYPE.
 - Any non-leaf node corresponding to a val rule MUST be a VALUE_TYPE.
 - Any non-leaf node corresponding to a ref rule MUST NOT be a VALUE_TYPE.
 - Otherwise, a non-leaf node with an expression child node is a VALUE_TYPE if and only if that expression child node is a VALUE_TYPE.

A parse tree for an Rgce MUST meet the following conditions:

- The NESTING_DEPTH of each leaf node MUST NOT exceed 8.
- The OPERAND_COUNT of the root node MUST NOT exceed 40.

0	1	2	3	4	5	6	7	8	9	1	0	1	2	3	4	5	6	7	8	9	2	0	1	2	3	4	5	6	7	8	9	3	0	1			
sequence (variable)																																					
...																																					

sequence (variable): An array of Ptg that specifies the sequence of Ptg.

2.5.198.105 RgceArea

The **RgceArea** structure specifies a reference to a rectangular **range** of **cells** where **relative references** are stored as coordinates.

0	1	2	3	4	5	6	7	8	9	1	0	1	2	3	4	5	6	7	8	9	2	0	1	2	3	4	5	6	7	8	9	3	0	1			
rowFirst																		rowLast																			
columnFirst																		columnLast																			

rowFirst (2 bytes): An [RwU](#) that specifies the row number of the first row of the rectangular range of cells.

rowLast (2 bytes): An [RwU](#) that specifies the row number of the last row of the rectangular range of cells.

columnFirst (2 bytes): A [ColRelU](#) that specifies the column number of the first column of the rectangular range of cells and relative reference information.

columnLast (2 bytes): A [ColRelU](#) that specifies the column number of the last column of the rectangular range of cells and relative reference information.

2.5.198.106 RgceAreaRel

The **RgceAreaRel** structure specifies a rectangular **range of cells** where the relative portions of **relative references** are specified as offsets from the cell in which the formula (section [2.2.2](#)) is evaluated.

0	1	2	3	4	5	6	7	8	9	10	1	2	3	4	5	6	7	8	9	20	1	2	3	4	5	6	7	8	9	30	1
rowFirst										rowLast																					
columnFirst										columnLast																					

rowFirst (2 bytes): An [RwU](#) that specifies information about the first row of the cell reference. If **columnFirst.rowRelative** is 0, then **rowFirst** specifies the first row coordinate of the cell reference. If **columnFirst.rowRelative** is 1, then **rowFirst** specifies the first row as an offset from the cell in which the formula is evaluated.

rowLast (2 bytes): An [RwU](#) that specifies information about the last row of the cell reference. If **columnLast.rowRelative** is 0, then **rowLast** specifies the last row coordinate of the cell reference. If **columnLast.rowRelative** is 1, then **rowLast** specifies the last row as an offset from the cell in which the formula is evaluated.

columnFirst (2 bytes): A [ColRelNegU](#) that specifies information about the first row and column in the range. If **columnFirst.colRelative** is 0, then **columnFirst.col** is an unsigned integer that specifies the first column coordinate of the cell reference and MUST be less than 256. If **columnFirst.colRelative** is 1, then **columnFirst.col** is a signed integer that specifies the first column as an offset from the cell in which the formula is evaluated.

columnLast (2 bytes): A [ColRelNegU](#) that specifies information about the first row and column in the range. If **columnLast.colRelative** is 0, then **columnLast.col** is an unsigned integer that specifies the last column coordinate of the cell reference and MUST be less than 256. If **columnLast.colRelative** is 1, then **columnLast.col** is a signed integer that specifies the last column as an offset from the cell in which the formula is evaluated.

2.5.198.107 RgceElfLoc

The **RgceElfLoc** structure specifies a location of a **cell** that contains a label used in a **natural language formula** to refer to a contiguous **range** of cells from the same row or column as the cell with the label.

0	1	2	3	4	5	6	7	8	9	10	1	2	3	4	5	6	7	8	9	20	1	2	3	4	5	6	7	8	9	30	1
row										column																					

row (2 bytes): An [RwU](#) that specifies the zero-based row coordinate of the cell.

column (2 bytes): A [ColEIfU](#) that specifies the zero-based column coordinate of the cell and other information about the cell reference.

2.5.198.108 RgceElfLocExtra

The **RgceElfLocExtra** structure specifies a single **cell reference** which specifies a part of a multiple-cell **natural language label**. The **cell** is specified as the intersection of the given row and column.

0	1	2	3	4	5	6	7	8	9	10	11	12	13	14	15	16	17	18	19	20	1	2	3	4	5	6	7	8	9	30	1
row																column															

row (2 bytes): An [RwU](#) that specifies the row coordinate of the cell reference.

column (2 bytes): A [ColRelU](#) that specifies the column coordinate of the cell reference. The values of **column.colRelative** and **column.rowRelative** MUST be ignored.

2.5.198.109 RgceLoc

The **RgceLoc** structure specifies a reference to a single **cell** where **relative references** are stored as coordinates.

0	1	2	3	4	5	6	7	8	9	10	11	12	13	14	15	16	17	18	19	20	1	2	3	4	5	6	7	8	9	30	1
row																column															

row (2 bytes): An [RwU](#) that specifies the row coordinate of the cell reference.

column (2 bytes): A [ColRelU](#) that specifies the column coordinate of the cell reference and relative reference information.

2.5.198.110 RgceLoc8

The **RgceLoc8** structure specifies a single **cell** reference.

0	1	2	3	4	5	6	7	8	9	10	11	12	13	14	15	16	17	18	19	20	1	2	3	4	5	6	7	8	9	30	1
rgceLoc																															
reserved																															

rgceLoc (4 bytes): A [RgceLoc](#) that specifies a single cell reference.

reserved (4 bytes): MUST be zero, and MUST be ignored.

2.5.198.111 RgceLocRel

The **RgceLocRel** structure specifies a single **cell** reference where the relative portions of **relative references** are specified as offsets from the cell in which the formula (section [2.2.2](#)) is evaluated.

0	1	2	3	4	5	6	7	8	9	10	11	12	13	14	15	16	17	18	19	20	21	22	23	24	25	26	27	28	29	30	31
row																column															

row (2 bytes): An [RwU](#) that specifies information about the row of the cell reference. If **column.rowRelative** is 0, then **row** specifies the row coordinate of the cell reference. If **column.rowRelative** is 1, then **row** specifies the row as an offset from the cell in which the formula is evaluated. If the signed result of the offset is a row index less than 0x00000000 or greater than 0x0000FFFF, the value is adjusted by 0x00010000 so that it will result in a valid row index.

column (2 bytes): A [ColRelNegU](#) that specifies information about the row and column. If **column.colRelative** is 0, then **column.col** is an unsigned integer that specifies the column coordinate of the cell reference and MUST be less than 256. If **column.colRelative** is 1, then **column.col** is a signed integer that specifies the column as an offset from the cell in which the formula is evaluated. If the signed result of the offset is a column index less than 0x0000 or greater than 0x00FF, the value is adjusted by 0x0100 so that it will result in a valid column index.

2.5.198.112 SerAr

The **SerAr** structure specifies a **cell** value within an array of values.

0	1	2	3	4	5	6	7	8	9	10	11	12	13	14	15	16	17	18	19	20	21	22	23	24	25	26	27	28	29	30	31
blob (variable)																															
...																															

blob (variable): A structure that specifies a cell value. MUST be one of the following structures: [SerNil](#), [SerNum](#), [SerStr](#), [SerBool](#), or [SerErr](#). The structure is specified by the first byte, which is the reserved byte in each of those structures.

2.5.198.113 SerBool

The **SerBool** structure specifies a Boolean (section [2.5.14](#)) value in an array of values.

0	1	2	3	4	5	6	7	8	9	10	11	12	13	14	15	16	17	18	19	20	21	22	23	24	25	26	27	28	29	30	31
reserved1								f								reserved2								unused1							
...								unused2																							
...																															

reserved1 (1 byte): Reserved. MUST be 0x04.

f (1 byte): A Boolean that specifies the value.

reserved2 (1 byte): MUST be zero, and MUST be ignored.

unused1 (2 bytes): Undefined and MUST be ignored.

unused2 (4 bytes): Undefined and MUST be ignored.

2.5.198.114 SerErr

The **SerErr** structure specifies an error value in an array of values.

0	1	2	3	4	5	6	7	8	9	10	11	12	13	14	15	16	17	18	19	20	21	22	23	24	25	26	27	28	29	30	31					
reserved1										err										reserved2					unused1											
...										unused2																										
...																																				

reserved1 (1 byte): Reserved. MUST be 0x10.

err (1 byte): A [BErr](#) that specifies the error code value.

reserved2 (1 byte): MUST be zero, and MUST be ignored.

unused1 (2 bytes): Undefined and MUST be ignored.

unused2 (4 bytes): Undefined and MUST be ignored.

2.5.198.115 SerNil

The **SerNil** structure specifies a null value in an array of values.

0	1	2	3	4	5	6	7	8	9	10	11	12	13	14	15	16	17	18	19	20	21	22	23	24	25	26	27	28	29	30	31					
reserved										unused1																										
...										unused2																										
...																																				

reserved (1 byte): MUST be zero, and MUST be ignored.

unused1 (4 bytes): Undefined and MUST be ignored.

unused2 (4 bytes): Undefined and MUST be ignored.

2.5.198.116 SerNum

The **SerNum** structure specifies a numeric value in an array of values.

0	1	2	3	4	5	6	7	8	9	10	11	12	13	14	15	16	17	18	19	20	21	22	23	24	25	26	27	28	29	30	31						
reserved										xnum																											
...																																					

...

reserved (1 byte): Reserved. MUST be 0x01.

xnum (8 bytes): An Xnum (section [2.5.342](#)) that specifies the value.

2.5.198.117 SerStr

The **SerStr** structure specifies a string in an array of values.

0	1	2	3	4	5	6	7	8	9	10	11	12	13	14	15	16	17	18	19	20	21	22	23	24	25	26	27	28	29	30	31
reserved										string (variable)																					
...																															

reserved (1 byte): Reserved. MUST be 0x02.

string (variable): An [XLUnicodeString](#) that specifies the string. The length of the string MUST be less than 256 characters.

2.5.198.118 SharedParsedFormula

The **SharedParsedFormula** structure specifies the formula (section [2.2.2](#)) for a shared formula.

0	1	2	3	4	5	6	7	8	9	10	11	12	13	14	15	16	17	18	19	20	21	22	23	24	25	26	27	28	29	30	31
cce										rgce (variable)																					
...																															
rgcb (variable)																															
...																															

cce (2 bytes): An unsigned integer that specifies the length of **rgce** in bytes. MUST be greater than 0.

rgce (variable): An [Rgce](#) that specifies the sequence of Ptg for the formula. MUST NOT contain [PtgExp](#), [PtgTbl](#), [PtgSxName](#), [PtgIsect](#), [PtgUnion](#), [PtgRange](#), [PtgArray](#), [PtgElfLel](#), [PtgElfRw](#), [PtgElfCol](#), [PtgElfRwV](#), [PtgElfColV](#), [PtgElfRadical](#), [PtgElfRadicalS](#), [PtgElfColS](#), [PtgElfColSV](#), [PtgElfRadicalLel](#), [PtgRefErr](#), [PtgAreaErr](#), [PtgRef3d](#), [PtgArea3d](#), [PtgRefErr3d](#), [PtgAreaErr3d](#), [PtgNameX](#), [PtgMemArea](#), [PtgMemErr](#), [PtgMemNoMem](#), or [PtgMemFunc](#).

If this field contains a [PtgRef](#), then the **loc.column.colRelative** and **loc.column.rowRelative** fields in the PtgRef MUST be 0.

If this field contains a [PtgArea](#), then the **area.columnFirst.colRelative**, **area.columnFirst.rowRelative**, **area.columnLast.colRelative**, and **area.columnLast.rowRelative** fields in the PtgArea MUST be 0.

If this field contains a [PtgFuncVar](#) and the **fCeFunc** field of the PtgFuncVar is 0, then the **tab** field of PtgFuncVar MUST NOT be 0x017B.

The root node of the parse tree of this field MUST be a VALUE_TYPE, as described in Rgce.

rgcb (variable): An [RgbExtra](#) that specifies ancillary data for the formula.

2.5.198.119 XtiIndex

XtiIndex is a 2-byte unsigned integer that specifies an [XTI](#) record. MUST be a value from the following table:

Value	Meaning
0xFFFF	Specifies an invalid XTI.
Greater than or equal to zero and less than 0xFFFF	Specifies a zero-based index of an XTI structure in the array specified by the rgXTI field of the ExternSheet record. The value MUST be less than the cXTI field of the ExternSheet record.

2.5.199 PBT

The **PBT** structure specifies information about a parameter in a **query** that retrieves **external data** for a [PivotTable](#) or a **query table**. The values in this structure provide additional information about the related [ParamQry](#) record as specified by the **rgPbt** field in the [DBQueryExt](#) record that contains this structure.

0	1	2	3	4	5	6	7	8	9	10	11	12	13	14	15	16	17	18	19	20	21	22	23	24	25	26	27	28	29	30	31
pbt			A	B	reserved																										

pbt (3 bits): An unsigned integer that specifies the location of the parameter value. MUST be the same as the **pbt** field in the related ParamQry record as specified by the **rgPbt** field in the DBQueryExt record that contains this structure. MUST be a value from the following table:

Value	Meaning
0x0	The user is prompted for the value of the parameter.
0x1	The parameter value is specified in the query.
0x2	The parameter value is specified in a cell .

A - fAutoRefresh (1 bit): A bit that specifies whether the query refreshes when the parameter value changes. If **pbt** is not equal to 0x2 then this bit MUST be zero, and MUST be ignored.

B - fNeedRefresh (1 bit): A bit that specifies that the parameter value changed and the query was not refreshed. MUST be 0 if **pbt** is not equal to 0x2.

reserved (11 bits): MUST be zero, and MUST be ignored.

2.5.200 PhRuns

The **PhRuns** structure specifies a **phonetic text run** that is displayed above a **text run**.

0	1	2	3	4	5	6	7	8	9	10	11	12	13	14	15	16	17	18	19	20	21	22	23	24	25	26	27	28	29	30	31
ichFirst																ichMom															
cchMom																															

ichFirst (2 bytes): A signed integer that specifies the zero-based index of the first character of the phonetic text run in the **rphssub.st** field of the [ExtRst](#) structure that contains this PhRuns structure. MUST be greater than or equal to 0.

ichMom (2 bytes): A signed integer that specifies the zero-based index of the first character of the text run in the **rgb** field of the [XLUnicodeRichExtendedString](#) that contains the ExtRst that contains this PhRuns that corresponds to the phonetic text run specified in **ichFirst**. **ichMom** specifies the location where the text run which phonetic text run specified in **ichFirst** applies to begins. MUST be greater than or equal to 0.

cchMom (2 bytes): A signed integer that specifies the count of characters in the text run specified in **ichMom**. MUST be greater than or equal to 0.

2.5.201 Phs

The **Phs** structure specifies the formatting information for a **phonetic string**.

0	1	2	3	4	5	6	7	8	9	10	11	12	13	14	15	16	17	18	19	20	21	22	23	24	25	26	27	28	29	30	31		
ifnt																A	B	unused															

ifnt (2 bytes): A [FontIndex](#) structure that specifies the font.

A - phType (2 bits): An unsigned integer that specifies the type of the phonetic information. MUST be a value from the following table:

Value	Meaning
0x0	Use narrow Katakana characters as phonetic string.
0x1	Use wide Katakana characters as phonetic string.
0x2	Use Hiragana characters as phonetic string.
0x3	Use any type of characters as phonetic string.

B - alch (2 bits): An unsigned integer that specifies the alignment of the phonetic string. MUST be a value from the following table:

Value	Alignment
0x0	General alignment
0x1	Left aligned
0x2	Center aligned
0x3	Distributed alignment

unused (12 bits): Undefined and MUST be ignored.

2.5.202 PictFmlaEmbedInfo

The **PictFmlaEmbedInfo** structure specifies information about the embedded control associated with the **Obj** record that contains the **ObjFmla** structure that contains this **PictFmlaEmbedInfo**. The embedded control can be an **ActiveX control**, an **OLE object** or a **camera picture** control. The **pictFlags** field of this **Obj** record specifies the type of embedded control.

0	1	2	3	4	5	6	7	8	9	10	11	12	13	14	15	16	17	18	19	20	21	22	23	24	25	26	27	28	29	30	31
ttb										cbClass										reserved						strClass (variable)					
...																															

ttb (1 byte): Reserved. MUST be 0x03.

cbClass (1 byte): An unsigned integer that specifies the length in bytes of the **strClass** field.

reserved (1 byte): MUST be zero, and MUST be ignored.

strClass (variable): An optional [XLUnicodeStringNoCch](#) structure that specifies the class name of the embedded control associated with this **Obj**. This field MUST exist if and only if **cbClass** is nonzero.

2.5.203 PictFmlaKey

The **PictFmlaKey** structure specifies the runtime **license key** of the object and specifies the reference to a **cell** that is linked to the picture **Obj** that contains this **PictFmlaKey**.

0	1	2	3	4	5	6	7	8	9	10	11	12	13	14	15	16	17	18	19	20	21	22	23	24	25	26	27	28	29	30	31
cbKey																															
keyBuf (variable)																															
...																															
fmlaLinkedCell (variable)																															
...																															
fmlaListFillRange (variable)																															
...																															

cbKey (4 bytes): An unsigned integer that specifies the number of bytes in the **keyBuf** string [<179>](#).

keyBuf (variable): An array of **cbKey** that specifies the license key for the **ActiveX control**. This field is passed to a license-aware object creation method.

fmlaLinkedCell (variable): An [ObjFmla](#) that specifies a reference to the **range** where the value of the first cell is linked to the current selection in this picture control. An empty formula, where **fmlaLinkedCell.cbFmla** equals zero, specifies there is no such cell linked to this picture control.

fmlaListFillRange (variable): An [ObjFmla](#) that specifies the range used to populate the content of this picture control. The **fmlaListFillRange.cbFmla** field MUST be 0 unless there is a bindable property (as specified in [\[MS-OAUT\]](#) section [2.2.49.5.2](#)) in the typelib of the ActiveX control that equals the GUID {0C733A7C-2A1C-11CE-ADE5-00AA0044773D}.

2.5.204 PivotCompProp

The **PivotCompProp** structure specifies the properties of a [PivotTable](#) string comparison.

0	1	2	3	4	5	6	7	8	9	10	11	12	13	14	15	16	17	18	19	20	21	22	23	24	25	26	27	28	29	30	31
fCompare										reserved1										reserved2											
...															reserved3																

fCompare (1 byte): A Boolean (section [2.5.14](#)) that specifies the type of string comparison.

Value	Meaning
0x0000	This is a wildcard pattern match. For the purposes of comparisons, the characters "?" and "*" are used as wildcards. A "?" refers to any single character, and a "*" refers to any number of characters.
0x0001	This is a simple string comparison.

reserved1 (1 byte): MUST be zero, and MUST be ignored.

reserved2 (4 bytes): MUST be zero, and MUST be ignored.

reserved3 (2 bytes): MUST be zero, and MUST be ignored.

2.5.205 PositionMode

The **PositionMode** structure specifies positioning mode for position information saved in a [Pos](#) record.

Name	Value	Meaning
MDFX	0x0000	Relative position to the chart , in points .
MDABS	0x0001	Absolute width and height in points. It can only be applied to the mdBotRt field of Pos.
MDPARENT	0x0002	Owner of Pos determines how to interpret the position data.
MDKTH	0x0003	Offset to default position, in 1/1000 th of the plot area size.
MDCHART	0x0005	Relative position to the chart, in SPRC .

2.5.206 ReadingOrder

The **ReadingOrder** enumeration specifies the **reading order**.

Name	Value	Meaning
READING_ORDER_CONTEXT	0x00	Context reading order
READING_ORDER_LTR	0x01	Left-to-right reading order
READING_ORDER_RTL	0x02	Right-to-left reading order

2.5.207 Ref

The **Ref** structure specifies a **range** of **cells** on a given **sheet**.

0	1	2	3	4	5	6	7	8	9	10	11	12	13	14	15	16	17	18	19	20	21	22	23	24	25	26	27	28	29	30	31
rwFirst											rwLast																				
colFirst											colLast																				

rwFirst (2 bytes): An unsigned integer that specifies the first zero-based row index in the range. MUST be greater than or equal to the **rwMic** field of the [Dimensions](#) record and MUST be less than the **rwMac** field of the Dimensions record. MUST be less than or equal to **rwLast**.

rwLast (2 bytes): An unsigned integer that specifies the last zero-based row index in the range. MUST be greater than or equal to the **rwMic** field of the Dimensions record and MUST be less than the **rwMac** field of the Dimensions record. MUST be greater than or equal to **rwFirst**.

colFirst (1 byte): A [ColByte](#) structure that specifies the first zero-based column index in the range. MUST be less than or equal to **colLast**.

colLast (1 byte): A ColByte structure that specifies the last zero-based column index in the range. MUST be greater than or equal to **colFirst**.

2.5.208 Ref8

The **Ref8** structure specifies a **range** of **cells** on the **sheet**.

0	1	2	3	4	5	6	7	8	9	10	11	12	13	14	15	16	17	18	19	20	21	22	23	24	25	26	27	28	29	30	31
rwFirst											rwLast																				
colFirst											colLast																				

rwFirst (2 bytes): A [Rwx](#) structure that specifies the first row in the range. The field **rwFirst.rw** MUST be less than or equal to **rwLast.rw**.

rwLast (2 bytes): A Rwx structure that specifies the last row in the range. The field **rwLast.rw** MUST be greater than or equal to **rwFirst.rw**. If **rwFirst.rw** is 0 and **rwLast.rw** is 0xFFFF, the specified range includes all the rows in the sheet.

colFirst (2 bytes): A [Colx](#) structure that specifies the first column in the range. The field **colFirst.col** MUST be less than or equal to **colLast.col**.

colLast (2 bytes): A Colx structure that specifies the last column in the range. The field **colLast.col** MUST be greater than or equal to **colFirst.col**. If **colFirst.col** is 0 and **colLast.col** is 0xFF, the specified range includes all the columns in the sheet.

2.5.209 Ref8U

The **Ref8U** structure specifies a **range** of **cells** on the **sheet**.

0	1	2	3	4	5	6	7	8	9	10	11	12	13	14	15	16	17	18	19	20	1	2	3	4	5	6	7	8	9	30	1
rwFirst																rwLast															
colFirst																colLast															

rwFirst (2 bytes): A **RwU** structure that specifies the zero-based index of the first row in the range. The value MUST be less than or equal to **rwLast**.

rwLast (2 bytes): A **RwU** structure that specifies the zero-based index of the last row in the range. The value MUST be greater than or equal to **rwFirst**.

colFirst (2 bytes): A **ColU** structure that specifies the zero-based index of the first column in the range. The value MUST be less than or equal to **colLast**, and MUST be less than or equal to 0x00FF.

colLast (2 bytes): A **ColU** structure that specifies the zero-based index of the last column in the range. The value MUST be greater than or equal to **colFirst**, and MUST be less than or equal to 0x00FF.

2.5.210 Ref8U2007

The **Ref8U2007** structure specifies a **range** of **cells** on the **sheet**.

0	1	2	3	4	5	6	7	8	9	10	11	12	13	14	15	16	17	18	19	20	1	2	3	4	5	6	7	8	9	30	1
rwFirst																															
rwLast																															
colFirst																															
colLast																															

rwFirst (4 bytes): An unsigned integer that specifies the zero-based index of the first row in the range. The value MUST be less than or equal to **rwLast** and MUST be less than or equal to 0xFFFF.

rwLast (4 bytes): An unsigned integer that specifies the zero-based index of the last row in the range. The value MUST be greater than or equal to **rwFirst** and MUST be less than or equal to 0xFFFF.

colFirst (4 bytes): An unsigned integer that specifies the zero-based index of the first column in the range. The value MUST be less than or equal to **colLast** and MUST be less than or equal to 0x00FF.

colLast (4 bytes): An unsigned integer that specifies the zero-based index of the last column in the range. The value MUST be greater than or equal to **colFirst** and MUST be less than or equal to 0x00FF.

2.5.211 RefU

The **RefU** structure specifies a **range** of cells on the **sheet**.

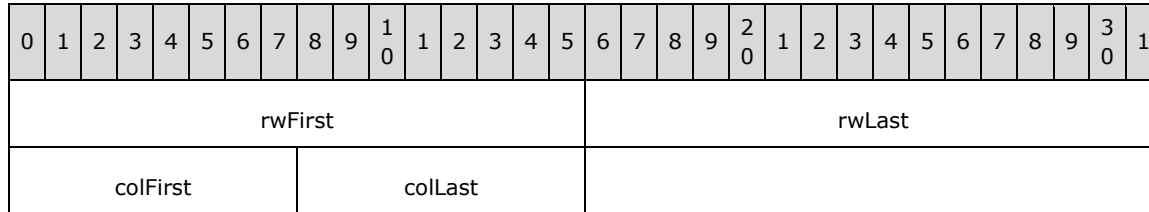

rwFirst (2 bytes): A **RwU** structure that specifies the first row in the range. The value MUST be less than or equal to **rwLast**.

rwLast (2 bytes): A **RwU** structure that specifies the last row in the range.

colFirst (1 byte): A **ColByteU** structure that specifies the first column in the range. The value MUST be less than or equal to **colLast**.

colLast (1 byte): A **ColByteU** structure that specifies the last column in the range.

2.5.212 RevisionType

RevisionType is an integer that specifies the type of [revision record](#). The value MUST be one of the following:

Name	Value	Meaning
REVTINSRW	0x0000	Insert Row.
REVTINSCOL	0x0001	Insert Column.
REVTDELROW	0x0002	Delete Row.
REVTDELCOL	0x0003	Delete Column.
REVTMOVE	0x0004	Cell Move.
REVTINSERTSH	0x0005	Insert Sheet .
REVTSORT	0x0007	Sort.
REVTCHANGECELL	0x0008	Cell Change.
REVTRENSHEET	0x0009	Rename Sheet.
REVTDEFNAME	0x000A	Defined name Change.
REVTFORMAT	0x000B	Format Revision.
REVTAUTOFMT	0x000C	AutoFormat Revision.
REVTNOTE	0x000D	Comment Revision.
REVTHEADER	0x0020	Header (meta-data) Revision.

Name	Value	Meaning
REVTCONFLICT	0x0025	Conflict.
REVTADDVIEW	0x002B	Custom view Add.
REVTDELVIEW	0x002C	Custom view Delete.
REVTTRASHQTFIELD	0x002E	Query table field Removal.

2.5.213 RFX

The **RFX** structure specifies a range of cells on the **sheet**.

0	1	2	3	4	5	6	7	8	9	10	11	12	13	14	15	16	17	18	19	20	21	22	23	24	25	26	27	28	29	30	31
rwFirst																															
rwLast																															
colFirst																															
colLast																															

rwFirst (4 bytes): A [Rw12](#) that specifies the first row in the range. The value of **rwFirst.rw** MUST be less than or equal to **rwLast.rw**.

rwLast (4 bytes): A [Rw12](#) that specifies the last row in the range. The value of **rwLast.rw** MUST be greater than or equal to **rwFirst.rw**.

colFirst (4 bytes): A [Col12](#) that specifies the first column in the range. The value of **colFirst.col** MUST be less than or equal to **colLast.col**.

colLast (4 bytes): A [Col12](#) that specifies the last column in the range. The value of **colLast.col** MUST be greater than or equal to **colFirst.col**.

2.5.214 RichTextStreamChecksumData

The **RichTextStreamChecksumData** structure specifies the data used to compute the **checksum** of the [RichTextStream](#) record. This data can be obtained from [Text](#) record, [FontX](#) record, [Font](#) record, [BRAI](#) record, and [ObjectLink](#) record associated with the RichTextStream record, as specified in RichTextStream. If no Text record is associated with the RichTextStream record, the Text record associated with the [DefaultText](#) record MUST be used. If no Font record is associated with the RichTextStream record, the first Font record specified in the [global substream](#) MUST be used.

0	1	2	3	4	5	6	7	8	9	10	11	12	13	14	15	16	17	18	19	20	21	22	23	24	25	26	27	28	29	30	31
fibFontInformation (variable)																															
...																															
A	B	C	bTextRotation								D	E	F	G	H	I	J	K	L	bSeriesIdentifier											

M	N	O	bTextFormat	StText (variable)
...				
fibFontInformationArray (variable)				
...				

fibFontInformation (variable): A [RichTextStreamChecksumFontInformation](#) structure that specifies the default **font** information to use for the rich text string.

A - fAutoSize (1 bit): A bit that specifies whether the font size is automatic. MUST be equal to 1 if the value of the **iFont** field of the related FontX record is 0. Otherwise, MUST be equal to 0. If no FontX record is associated with the RichTextStream record, MUST be equal to 0.

B - fAutoColor (1 bit): A bit that specifies whether the foreground text color is determined automatically. MUST be equal to the value of the **fAutoColor** field of the related Text record.

C - fAutoMode (1 bit): A bit that specifies if the background color is determined automatically. MUST be equal to the value of the **fAutoMode** field of the related Text record.

bTextRotation (8 bits): An unsigned integer that specifies the text rotation. MUST be equal to the value of the **trot** field of the related Text record.

D - fAutoRot (1 bit): MUST be zero.

E - reserved1 (1 bit): MUST be 1, and MUST be ignored.

F - iReadingOrder (2 bits): An unsigned integer that specifies the text **reading order**. MUST be equal to the value of the **iReadingOrder** field of the related Text record.

G - reserved2 (1 bit): MUST be zero, and MUST be ignored.

H - fAttached (1 bit): A bit that specifies whether the text position is absolute or attached. If the RichTextStream record is contained in the sequence of records that conforms to the [LD](#) rule, this field MUST be 1. If the RichTextStream is not contained in the LD rule, and the **dlp** field of the associated Text record is set to 0xA, this field MUST be 1. Otherwise, it MUST be 0.

I - fUserPos (1 bit): A bit that specifies whether the text position is automatic. If the value is 0, the text position is automatic. If the **dlp** field of the associated Text record is set to 0xA, this field MUST be 1. Otherwise, it MUST be 0.

J - bObjectType (4 bits): An unsigned integer that specifies the object type. Based on the record the RichTextStream is associated with, the value MUST be from the following table:

Record associated with RichTextStream	Value	Meaning
Chart	0x1	Default text associated with the chart .
Axis where wType is 0x0001	0x2	Attached label of the value axis (or the vertical value axis) in the primary axis group.
Axis where wType is 0x0000	0x3	Attached label of the category (2) axis (or the horizontal value axis) in the primary axis group.
Series	0x4	Attached label of the series .
Legend	0x5	Attached label of the legend .

Record associated with RichTextStream	Value	Meaning
Axis where wType is 0x0003	0x7	Attached label of the series axis.
Second Axis record where wType is 0x0001	0x8	Attached label of the value axis (or the vertical value axis) in the secondary axis group.
Second Axis record where wType is 0x0000	0x9	Attached label of the category (2) axis (or the horizontal value axis) in the secondary axis group.
DataTable	0xB	Attached label of the chart DataTable.
YMult	0xC	Attached label of the axis multiplier.

K - fBuildable (1 bit): A bit that specifies whether the text value of the Text record associated with the RichTextStream is automatically generated and unchanged. MUST be equal to the value of the **fAutoText** field of the related Text record.

L - reserved3 (1 bit): MUST be zero, and MUST be ignored.

bSeriesIdentifier (8 bits): An unsigned integer that specifies the zero-based index of the Series record of the current chart to which the attached label is attached.

M - reserved4 (2 bits): MUST be 0x3, and MUST be ignored.

N - fReference (2 bits): An unsigned integer that specifies the type of data that is being referenced. MUST be equal to the value of the **rt** field of the BRAI record associated with the RichTextStream.

O - stSource (4 bits): An unsigned integer that specifies the part of the series, [trendline](#), or [error bars](#) the referenced data of the BRAI record associated with the RichTextStream specifies. MUST be equal to the value of the **id** field of the BRAI record associated with the RichTextStream.

bTextFormat (8 bits): An [IFmt](#) that specifies the number formatting used for the data. MUST be equal to the value of the **ifmt** field of the BRAI record associated with the RichTextStream.

StText (variable): An array of **Unicode** characters that contains the text content of the rich text. This field only takes the text content into consideration and ignores the size and header fields of the text string. If the RichTextStream is associated with a BRAI record, the text value MUST correspond to the text value identified by the BRAI record. If the RichTextStream record is associated with an ObjectLink record, the text value MUST correspond to the text value identified by the ObjectLink record.

fibFontInformationArray (variable): An array of [RichTextStreamChecksumFontInformationArrayItem](#) that specifies the formatting of the **StText** field.

2.5.215 RichTextStreamChecksumFontInformation

The **RichTextStreamChecksumFontInformation** structure specifies the data used to compute the **checksum** of the [RichTextStream](#) record. This data can be obtained from [Text](#) and [Font](#) records associated with the RichTextStream record, as specified in RichTextStream. If no Text record is associated with the RichTextStream record, the Text record associated with the [DefaultText](#) record MUST be used. If no Font record is associated with the RichTextStream record, the first Font record specified in the [global substream](#) MUST be used.

0	1	2	3	4	5	6	7	8	9	10	11	12	13	14	15	16	17	18	19	20	21	22	23	24	25	26	27	28	29	30	31
stFontName (variable)																															
...																															
dwFontHeight																															
A	B	C	D	E	F	G	H	I	J	K	reserved1										boldness										
subscript											bUnderline										bFamily										
bCharset											reserved2										rgbFontColor										
...											dwDrawingMode																				
...																															

stFontName (variable): An array of **Unicode** characters that contains the **font** name. MUST be the font name specified by the **fontName** field of the related Font record.

dwFontHeight (4 bytes): An unsigned integer that specifies the font height. MUST equal the value specified by the **dyHeight** field of the related Font record.

A - fBold (1 bit): A bit that specifies whether the font is bold. The value of this field MUST be 1 when the value of the **bls** field of the associated Font record is greater than 400.

B - fItalic (1 bit): A bit that specifies whether the font is italic. MUST equal the value specified by the **fItalic** field of the related Font record.

C - fUnderline (1 bit): A bit that specifies whether the font is single-underlined. The value of this field MUST be 1 when the value of the **uls** field of the associated Font record is not equal to 0x00.

D - fOutline (1 bit): A bit that specifies whether the font has an **outline effect** applied. MUST equal the value specified by the **fOutline** field of the related Font record.

E - fShadow (1 bit): A bit that specifies whether the font has a **shadow effect** applied. MUST equal the value specified by the **fShadow** field of the related Font record.

F - fCondense (1 bit): A bit that specifies whether the font is condensed. MUST equal the value specified by the **fCondense** field of the related Font record.

G - fExtend (1 bit): A bit that specifies whether the font is extended. MUST equal the value specified by the **fExtend** field of the related Font record

H - fStrikeout (1 bit): A bit that specifies whether the font has **strikethrough formatting** applied. MUST equal the value specified by the **fStrikeOut** field of the related Font record.

I - fRegular (1 bit): A bit that specifies whether the font is a regular font. MUST equal 1.

J - fJon (1 bit): A bit that specifies whether the font is too small to be displayed. MUST equal 1 if the font height in **pixels** is less than 6.

K - fDialogBox (1 bit): A bit that specifies whether the font is used in the context of a dialog box. MUST equal 0.

reserved1 (5 bits): MUST be zero, and MUST be ignored.

boldness (2 bytes): An unsigned integer that specifies the font weight. MUST equal the value specified by the **bls** field of the related Font record.

subscript (2 bytes): An unsigned integer that specifies whether superscript, subscript, or normal script is used. MUST equal the value specified by the **sss** field of the related Font record.

bUnderline (1 byte): An unsigned integer that specifies the underline style. MUST equal the value specified by the **uls** field of the related Font record.

bFamily (1 byte): An unsigned integer that specifies the **font family** of this font. MUST equal the value specified by the **bFamily** field of the related Font record.

bCharset (1 byte): An unsigned integer that specifies the **character set**. MUST equal the value specified by the **bCharSet** field of the related Font record.

reserved2 (1 byte): MUST be zero, and MUST be ignored.

rgbFontColor (4 bytes): A [LongRGB](#) that specifies the font color. MUST equal the color specified by the **icv** field of the related Font record.

dwDrawingMode (4 bytes): An unsigned integer that specifies the display mode of the background of the text. MUST be equal to 0x0000010D when the **wBkgMode** field of the related Text record is equal to 0x0001; otherwise, it MUST be equal to 0x0000020D.

2.5.216 RichTextStreamChecksumFontInformationArrayItem

The **RichTextStreamChecksumFontInformationArrayItem** structure specifies data used to compute the checksum of the [RichTextStream](#) record.

0	1	2	3	4	5	6	7	8	9	10	11	12	13	14	15	16	17	18	19	20	21	22	23	24	25	26	27	28	29	30	31		
iIndex																fibFontInformation (variable)																	
...																																	

iIndex (2 bytes): An unsigned integer that specifies a zero-based index of the character within the **StText** field of the containing [RichTextStreamChecksumData](#) structure where the text formatting specified in **fibFontInformation** begins.

fibFontInformation (variable): A [RichTextStreamChecksumFontInformation](#) that specifies the **font** formatting of the text string starting at the **iIndex** character.

2.5.217 RkNumber

The **RkNumber** structure specifies a numeric value.

0	1	2	3	4	5	6	7	8	9	10	11	12	13	14	15	16	17	18	19	20	21	22	23	24	25	26	27	28	29	30	31
A	B	num																													

A - fX100 (1 bit): A bit that specifies whether **num** is the value of the RkNumber or 100 times the value of the RkNumber. MUST be a value from the following table:

Value	Meaning
0	The value of RkNumber is the value of num .
1	The value of RkNumber is the value of num divided by 100.

B - fInt (1 bit): A bit that specifies the type of **num**.

num (30 bits): A variable type field whose type and meaning is specified by the value of **fInt**, as defined in the following table:

Value of fInt	Type of num
0	num is the 30 most significant bits of a 64-bit binary floating-point number as defined in [IEEE754] . The remaining 34-bits of the floating-point number MUST be 0.
1	num is a signed integer.

2.5.218 RkRec

The **RkRec** structure contains the numeric data in an application-specific internal type for optimizing disk and memory space along with the corresponding [IXFCell](#) to the style record.

0	1	2	3	4	5	6	7	8	9	10	11	12	13	14	15	16	17	18	19	20	21	22	23	24	25	26	27	28	29	30	31
ixfe															RK																
...																															

ixfe (2 bytes): An IXFCell that specifies the format of the numeric value.

RK (4 bytes): An [RkNumber](#) that specifies the numeric value.

2.5.219 RPHSSub

The **RPHSSub** structure specifies a **phonetic string**.

0	1	2	3	4	5	6	7	8	9	10	11	12	13	14	15	16	17	18	19	20	21	22	23	24	25	26	27	28	29	30	31
crun															cch																
st (variable)																															
...																															

crun (2 bytes): An unsigned integer that specifies the number of **phonetic text runs**. MUST be less than or equal to 32767. If **crun** is zero, there is one phonetic text run.

cch (2 bytes): An unsigned integer that specifies the number of characters in the phonetic string. MUST be less than or equal to 32767.

st (variable): An [LPWideString](#) that specifies the phonetic string. The character count in the string MUST be **cch**.

2.5.220 RRD

The **RRD** structure specifies the [revision record](#) information used to track changes in a [shared workbook](#).

0	1	2	3	4	5	6	7	8	9	10	11	12	13	14	15	16	17	18	19	20	21	22	23	24	25	26	27	28	29	30	31
cbMemory																															
revid																															
revt																A	B	C	D	reserved											
tabid																															

cbMemory (4 bytes): An unsigned integer that specifies the size in bytes of the corresponding revision record structure in memory. This is different from the size of the structure written to the file. The value MUST be greater than or equal to 26. MUST be ignored if the current record is [RRDHead](#).

revid (4 bytes): A signed integer that specifies the revision identifier of the revision records. This identifier is used to keep track of the order of revision records. MUST be greater than or equal to 0.

revt (2 bytes): A [RevisionType](#) that specifies the type of revision record.

A - fAccepted (1 bit): A bit that specifies whether this revision was reviewed and accepted.

B - fUndoAction (1 bit): A bit that specifies whether the revision occurred because of an undo action.

C - unused (1 bit): Undefined and MUST be ignored.

D - fDelAtEdgeOfSort (1 bit): A bit that specifies whether the row or column that is being deleted is at the edge of a sorted **range**. If the value is 1, the current record MUST be [RRDInsDel](#) and **revt** MUST be equal to **REVTINSRW** or **REVTINSCOL** or **REVTDELRW** or **REVTDELCOL**.

reserved (12 bits): MUST be zero, and MUST be ignored.

tabid (2 bytes): A [TabId](#) that specifies the **sheet** where the revision occurred. If the value is 0xFFFF, this revision does not correspond to a specific sheet.

2.5.221 RRDDefNameFlags

The **RRDDefNameFlags** structure specifies additional information for [RRDDefName](#).

0	1	2	3	4	5	6	7	8	9	10	11	12	13	14	15	16	17	18	19	20	21	22	23	24	25	26	27	28	29	30	31
cce																A	B	fGrp						chKey							
C	D	E	F	G	reserved																										

cce (2 bytes): An unsigned integer that specifies the length of a formula (section [2.2.2](#)) in RRDDefName.

A - fPli (1 bit): A bit that specifies that one or more of the fields **stDescription**, **stHelpTopic**, **stCustomMenu**, **stStatusText**, **stDescriptionOld**, **stHelpTopicOld**, **stCustomMenuOld** or **stStatusTextOld** specified in the RRDDefName record MUST NOT be empty.

B - fFunc (1 bit): A bit that specifies whether the RRDDefName record specifies a name that refers to a function.

fGrp (6 bits): An unsigned integer that specifies the **function category** for the **defined name**. MUST be a value from the following table:

Value	Category
0	All
1	Financial
2	Date Time
3	Math Trigonometry
4	Statistical
5	Lookup
6	Database
7	Text
8	Logical
9	Info
10	Commands
11	Customize
12	Macro Control
13	DDE External
14	User Defined

chKey (8 bits): An unsigned integer that specifies the shortcut key. MUST have same restrictions as the **chKey** field from the [Lb](#) record.

C - fHidden (1 bit): A bit that specifies whether the defined name is hidden.

D - fCustomMenu (1 bit): A bit that specifies whether the **stCustomMenu** field from the RRDDefName record is not empty.

E - fDescription (1 bit): A bit that specifies whether the **stDescription** field from the RRDDefName record is not empty.

F - fHelpTopic (1 bit): A bit that specifies whether the **stHelpTopic** field from the RRDDefName record is not empty.

G - fStatusText (1 bit): A bit that specifies whether the **stStatusText** field from the RRDDefName record is not empty.

reserved (11 bits): MUST be zero, and MUST be ignored.

2.5.222 RRLoc

The **RRLoc** structure specifies the location of a **cell** in the **sheet**.

0	1	2	3	4	5	6	7	8	9	10	11	12	13	14	15	16	17	18	19	20	1	2	3	4	5	6	7	8	9	30	1
rw																col															

rw (2 bytes): A [RwU](#) structure that specifies the zero-based index of the row.

col (2 bytes): A [ColEIfU](#) structure that specifies the zero-based index of the column and other information about this cell reference.

2.5.223 RTDEItem

The **RTDEItem** structure specifies the **cell** associated with an **RTD topic**.

0	1	2	3	4	5	6	7	8	9	10	11	12	13	14	15	16	17	18	19	20	1	2	3	4	5	6	7	8	9	30	1
rw																col															
itab																															

rw (2 bytes): A [Rw](#) structure that specifies the row index of the cell.

col (2 bytes): A [Col](#) structure that specifies the column index of the cell.

itab (2 bytes): A [TabIndex](#) structure that specifies the **sheet** containing the cell.

2.5.224 RTDOper

The **RTDOper** structure specifies the variant data returned from an **RTD server** for **real-time data (RTD)**.

0	1	2	3	4	5	6	7	8	9	10	11	12	13	14	15	16	17	18	19	20	1	2	3	4	5	6	7	8	9	30	1
grbit																															
rtdVt (variable)																															
...																															

grbit (4 bytes): An unsigned integer that specifies the type of the variant data stored in **rtdVt**. MUST be a value from the following table:

Value	rtdVt Data Type	Meaning
0x00000001	Xnum	The returned variant is an Xnum (section 2.5.342).
0x00000002	RTDOperStr	The returned variant is a RTDOperStr. MUST be less than 256 characters long.
0x00000004	Boolean	The returned variant is a 4-byte Boolean (section 2.5.14) value.

Value	rtdVt Data Type	Meaning
0x00000010	Signed integer	The returned variant is a 4-byte signed integer indicating an error code.
0x00000800	Signed integer	The returned variant is a 4-byte signed integer used for purposes other than an error code.
0x00001000	RTDOperStr	The returned variant is a RTDOperStr. MUST be greater than or equal to 256 characters long.

rtdVt (variable): A structure that contains the variant data. The meaning of the data depends on the specific RTD server. The type of the variant data is specified by **grbit**.

2.5.225 RTDOperStr

The **RTDOperStr** structure specifies a string used in a **real-time data (RTD)** variant data structure.

0	1	2	3	4	5	6	7	8	9	10	1	2	3	4	5	6	7	8	9	20	1	2	3	4	5	6	7	8	9	30	1
cchRTDOperStr																															
rgchRTDOperStr (variable)																															
...																															

cchRTDOperStr (4 bytes): An unsigned integer that specifies the number of characters in **rgchRTDOperStr**.

rgchRTDOperStr (variable): An [XLUnicodeStringNoCch](#) that specifies the string.

2.5.226 Run

The **Run** structure specifies formatting information for a **text run**.

0	1	2	3	4	5	6	7	8	9	10	1	2	3	4	5	6	7	8	9	20	1	2	3	4	5	6	7	8	9	30	1
formatRun																															
unused1																unused2															

formatRun (4 bytes): A [FormatRun](#). It specifies the formatting information of this run.

unused1 (2 bytes): Undefined and MUST be ignored.

unused2 (2 bytes): Undefined and MUST be ignored.

2.5.227 Rw

The **Rw** structure specifies the zero-based row index of a row in a **sheet**.

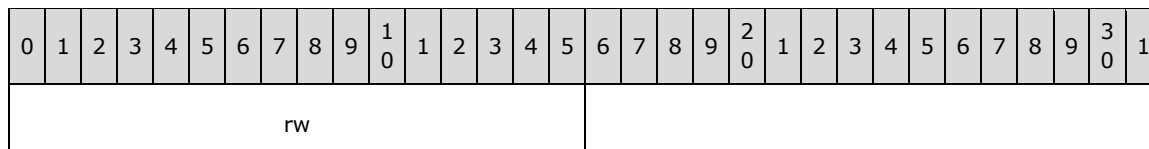

rw (2 bytes): An unsigned integer that specifies the zero-based row index of a row in the sheet that contains this structure. MUST be 0, 0xFFFF, or greater than or equal to the **rwMic** field of the [Dimensions](#) record of the sheet that contains this structure and less than the **rwMac** field of the Dimensions record of the sheet that contains this structure.

2.5.232 Script

The **Script** enumeration specifies the superscript or subscript style.

Name	Value	Meaning
SSSNONE	0x0000	Normal script
SSSSUPER	0x0001	Superscript
SSSSUB	0x0002	Subscript

2.5.233 SD_SetSortOrder

The **SD_SetSortOrder** enumeration specifies the types of [MDX set metadata](#) sorting orders.

Name	Value	Meaning
SSONONE	0x00	No sorting order
SSOASC	0x01	Ascending order
SSODESC	0x02	Descending order
SSOALPHAASC	0x03	Ascending order by the caption
SSOALPHADESC	0x04	Descending order by the caption
SSONATURALASC	0x05	Ascending order by the natural order of the data, for example, by a key
SSONATURALDESC	0x06	Descending order by the natural order of the data, for example, by a key

2.5.234 SDContainer

The **SDContainer** structure specifies security information for a [FeatProtection](#) record.

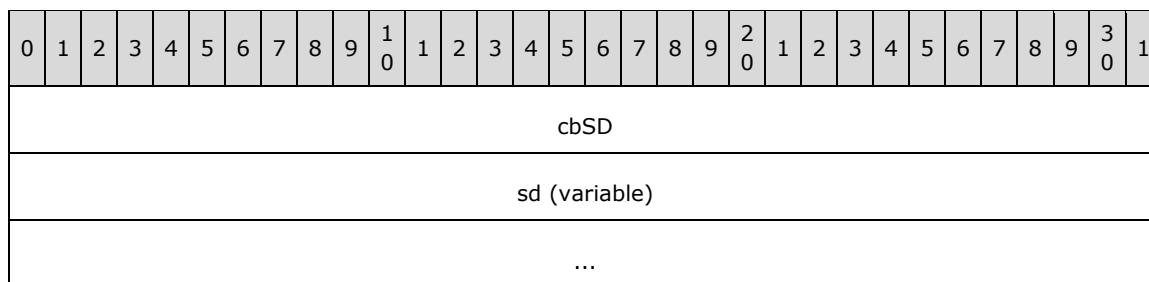

cbSD (4 bytes): An unsigned integer that specifies the size of the **sd** field in bytes. MUST be greater than 20.

sd (variable): A [SecurityDescriptor](#) that specifies the **security descriptor** data.

2.5.235 SecurityDescriptor

A SECURITY_DESCRIPTOR structure, as defined in [\[MS-DTYP\]](#) section 2.4.6, that specifies a **relative security descriptor** that specifies security information associated with an object. For more information about relative security descriptors see [\[MSDN-ASRSD\]](#).

2.5.236 ShapePropsStreamChecksumData

The **ShapePropsStreamChecksumData** structure specifies the data used to compute the **checksum** of the [ShapePropsStream](#) record.

0	1	2	3	4	5	6	7	8	9	10	11	12	13	14	15	16	17	18	19	20	21	22	23	24	25	26	27	28	29	30	31
linePropertiesForChecksum																															
...																															
interiorColorPropertiesForChecksum																															
...																															
...																fillStylePropertiesForChecksum (variable)															
...																															

linePropertiesForChecksum (8 bytes): A [LinePropertiesForShapePropsStreamChecksum](#) that specifies the line properties data used to compute the checksum of the ShapePropsStream record.

This field MUST be present in the following scenarios:

- When the ShapePropsStream record and [LineFormat](#) record exist in a [chart_group](#) but not in a sequence of records that conforms to the [LD](#) rule or a sequence of records that conforms to the DROPBAR rule;
- When the ShapePropsStream record and LineFormat record exist in a sequence of records that conforms to the FRAME rule;
- When the ShapePropsStream record and LineFormat record exist in a sequence of records that conforms to the DROPBAR rule;
- When the ShapePropsStream record and LineFormat record exist in a sequence of records that conforms to the AXS rule;
- When the ShapePropsStream record and LineFormat record exist in a sequence of records that conforms to the SS rule and the **wObjContext** field of the ShapePropsStream record is 0x0000;

This field MUST NOT be present otherwise.

interiorColorPropertiesForChecksum (9 bytes): An [InteriorColorPropertiesForShapePropsStreamChecksum](#) that specifies the interior color data used

to compute the checksum of the ShapePropsStream record. This field MUST be present in the following scenarios:

- When the ShapePropsStream record and [AreaFormat](#) record exist in sequence of records that conforms to the FRAME rule and the fAuto field of the AreaFormat record is 0x0 and the [GelFrame](#) record does not exist in the sequence of records;
- When the ShapePropsStream record and AreaFormat record exist in a sequence of records that conforms to the DROPBAR rule and the fAuto field of the AreaFormat record is 0x0 and the GelFrame record does not exist in the sequence of records;
- When the ShapePropsStream record and AreaFormat record exist in a sequence of records that conforms to the AXS rule and the **wObjContext** field of the ShapePropsStream record is 0x0003 and the fAuto field of the AreaFormat record is 0x0 and the GelFrame record does not exist in the sequence of records;
- When the ShapePropsStream record and AreaFormat record exist in a sequence of records that conforms to the SS rule and the fAuto field of the AreaFormat record is 0x0 and the GelFrame record does not exist in the sequence of records and the **wObjContext** field of the ShapePropsStream record is 0x0000;
- When the ShapePropsStream record, AreaFormat record, and [MarkerFormat](#) record exist in a sequence of records that conforms to the SS rule and the GelFrame record does not exist in the sequence of records and the **wObjContext** field of the ShapePropsStream record is 0x0001.

This field MUST NOT be present otherwise.

fillStylePropertiesForChecksum (variable): A [FillStylePropertiesForShapePropsStreamChecksum](#) that specifies the fill-style data used to compute the checksum of the ShapePropsStream record. This field MUST be present in the following scenarios:

- When the ShapePropsStream record, AreaFormat record, and GelFrame record exist in a sequence of records that conforms to the FRAME rule and the fAuto field of the AreaFormat record is 0x0;
- When the ShapePropsStream record, AreaFormat record, and GelFrame record exist in a sequence of records that conforms to the DROPBAR rule and the fAuto field of the AreaFormat record is 0x0;
- When the ShapePropsStream record, AreaFormat record, and GelFrame record exist in a sequence of records that conforms to the AXS rule and the **wObjContext** field of the ShapePropsStream record is 0x0003 and the fAuto field of the AreaFormat record is 0x0;
- When the ShapePropsStream record, AreaFormat record, and GelFrame record exist in a sequence of records that conforms to the SS rule and the fAuto field of the AreaFormat record is 0x0 and the **wObjContext** field of the ShapePropsStream record is 0x0000;
- When the ShapePropsStream record, AreaFormat record, MarkerFormat record, and GelFrame record sequence of records that conforms to the SS rule and the fAuto field of the AreaFormat record is 0x0 and the **wObjContext** field of the ShapePropsStream record is 0x0001.

This field MUST NOT be present otherwise.

2.5.237 SharedFeatureType

The **SharedFeatureType** enumeration specifies the different types of [Shared Features](#).

Name	Value	Meaning
ISFPROTECTION	0x0002	Specifies the enhanced protection type. A Shared Feature of this type is used to protect a shared workbook by restricting access to the areas of the workbook and to the available functionality.

Name	Value	Meaning
ISFFEC2	0x0003	Specifies the ignored formula errors type. A Shared Feature of this type is used to specify the formula errors to be ignored.
ISFFACTOID	0x0004	Specifies the smart tag type. A Shared Feature of this type is used to recognize certain types of entries (for example, proper names, dates/times, financial symbols) and flag them for action.
ISFLIST	0x0005	Specifies the list type. A Shared Feature of this type is used to describe a table within a sheet .

2.5.238 SheetExtOptional

The **SheetExtOptional** structure specifies **sheet** specific data including **sheet tab** color and the **published** state of this sheet.

0	1	2	3	4	5	6	7	8	9	10	11	12	13	14	15	16	17	18	19	20	21	22	23	24	25	26	27	28	29	30	31						
icvPlain12							A	B	reserved																												
color (16 bytes)																																					
...																																					
...																																					

icvPlain12 (7 bits): An unsigned integer that specifies the tab color of this sheet. If the tab has a color assigned to it, the value of this field **MUST** be greater than or equal to 0x08 and less than or equal to 0x3F, as specified in the color table for [Icv](#). If this value does not equal to **icvPlain** of the associated [SheetExt](#), the value of **icvPlain** takes precedence. If the tab has no color assigned to it, the value of this field **MUST** be 0x7F, and **MUST** be ignored.

A - fCondFmtCalc (1 bit): A bit that specifies whether **conditional formatting** formulas are evaluated. **MUST** be one of the following:

Value	Meaning
0	Conditional formatting formulas in this workbook are not evaluated.
1	Conditional formatting formulas in this workbook are evaluated.

B - fNotPublished (1 bit): A bit that specifies whether this sheet is published. **MUST** be ignored when this sheet is a [chart sheet](#), [dialog sheet](#), or [macro sheet](#). **MUST** be a value from the following table:

Value	Meaning
0	The sheet is published.
1	The sheet is not published.

reserved (23 bits): **MUST** be zero, and **MUST** be ignored.

color (16 bytes): A [CFColor](#) that specifies the tab color. Used only when the tab color was not modified by earlier versions of the application.

2.5.239 ShortDTR

The **ShortDTR** structure specifies date and time. The **year**, **month**, and **day** values MUST be consistent with the Gregorian calendar.

0	1	2	3	4	5	6	7	8	9	10	11	12	13	14	15	16	17	18	19	20	21	22	23	24	25	26	27	28	29	30	31
year												month										day									
hour					minute							second					weekday														

year (2 bytes): An unsigned integer that specifies the year. MUST be greater than or equal to 1900 and less than or equal to 9999.

month (1 byte): An unsigned integer that specifies the month. MUST be greater than or equal to 1 and less than or equal to 12.

day (1 byte): An unsigned integer that specifies the day. MUST be greater than or equal to 1 and less than or equal to 31.

hour (1 byte): An unsigned integer that specifies the hour. MUST be greater than or equal to 0 and less than or equal to 23.

minute (1 byte): An unsigned integer that specifies the minute. MUST be greater than or equal to 0 and less than or equal to 59.

second (1 byte): An unsigned integer that specifies the second. MUST be greater than or equal to 0 and less than or equal to 59.

weekday (1 byte): An unsigned integer that specifies the weekday. The value MUST be one of the following:

Value	Meaning
0	The weekday is not specified.
1	Monday
2	Tuesday
3	Wednesday
4	Thursday
5	Friday
6	Saturday
7	Sunday

2.5.240 ShortXLUnicodeString

The **ShortXLUnicodeString** structure specifies a Unicode string.

0	1	2	3	4	5	6	7	8	9	10	11	12	13	14	15	16	17	18	19	20	21	22	23	24	25	26	27	28	29	30	31
cch									A	reserved							rgb (variable)														
...																															

cch (1 bytes): An unsigned integer that specifies the count of characters in the string.

A - fHighByte (1 bit): A bit that specifies whether the characters in **rgb** are double-byte characters. MUST be a value from the following table:

Value	Meaning
0x0	All the characters in the string have a high byte of 0x00 and only the low bytes are in rgb .
0x1	All the characters in the string are saved as double-byte characters in rgb .

reserved (7 bits): MUST be zero, and MUST be ignored.

rgb (variable): An array of bytes that specifies the characters. If **fHighByte** is 0x0, the size of the array MUST be equal to the value of **cch**. If **fHighByte** is 0x1, the size of the array MUST be equal to the value of **cch*2**.

2.5.241 SLC08

The **SLC08** structure specifies a reference to a **cell** in a [SCENARIO](#) record.

0	1	2	3	4	5	6	7	8	9	10	11	12	13	14	15	16	17	18	19	20	21	22	23	24	25	26	27	28	29	30	31
rw																col															

rw (2 bytes): A [RwU](#) structure that specifies the zero-based index of the row of the cell.

col (2 bytes): A [ColSlco8U](#) structure that specifies the zero-based index of the column of the cell and other information about this cell reference.

2.5.242 SortCond12

The **SortCond12** structure specifies the sort conditions.

0	1	2	3	4	5	6	7	8	9	10	11	12	13	14	15	16	17	18	19	20	21	22	23	24	25	26	27	28	29	30	31
A	sortOn	reserved							rfx (16 bytes)																						
...																															
...																															
...																condData (variable)															
...																															

cchSt
stSslist (variable)
...

A - fSortDes (1 bit): A bit that specifies whether to sort in descending order.

sortOn (4 bits): An unsigned integer that specifies the kind of sort to perform. MUST be a value listed in the Sort On Value column in the table for **condData**.

reserved (11 bits): MUST be zero, and MUST be ignored.

rfx (16 bytes): An [RFX](#) that specifies the sort range of cells on the **sheet**.

condData (variable): A structure that specifies the conditional data information. The data type of this structure depends on the value of the **sortOn** field and MUST be a value from the following table:

Sort On Value	Data Type
0x0	CondDataValue
0x1	CondDataValue
0x2	CondDataValue
0x3	CFFlag

cchSt (4 bytes): A signed integer that specifies the character count in **stSslist**. MUST be greater than or equal to zero. MUST be zero and ignored if **sortOn** is not equal to zero.

stSslist (variable): An [XLUnicodeStringNoCch](#) that specifies the custom sort list string. It exists only if **cchSt** is greater than zero.

2.5.243 SortItem

The **SortItem** structure specifies the sort mapping from the old row/column index (before sort action) to the new row/column index (after sort action). An array of these structures is contained within a [RRSort](#) record.

0	1	2	3	4	5	6	7	8	9	10	1	2	3	4	5	6	7	8	9	20	1	2	3	4	5	6	7	8	9	30	1		
iNewIndex																																	
iOldIndex																																	

iNewIndex (4 bytes): An unsigned integer that specifies the new zero-based index of row or column. If the **fCol** field of the **RRSort** record that contains this structure is zero, then this value is a zero-based row index and MUST be within the range of rows specified in the **ref8** field of the **RRSort** record that contains this structure. If the **fCol** field of the **RRSort** record that contains this structure is 1, then this value is a zero-based column index and MUST be within the range of columns specified in the **ref8** field of the **RRSort** record that contains this structure.

iOldIndex (4 bytes): An unsigned integer that specifies the old zero-based index of row or column. If the **fCol** field of the **RRSort** record that contains this structure is zero, then this value is a zero-

based row index and MUST be within the range of rows specified in the **ref8** field of the RRSort record that contains this structure. If the **fCol** field of the RRSort record that contains this structure is 1, then this value is a zero-based column index and MUST be within the range of columns specified in the **ref8** field of the RRSort record that contains this structure.

2.5.244 SourceType

The **SourceType** enumeration specifies the source type for a **table**.

Name	Value	Meaning
LTRANGE	0x00000000	Range
LTSHAREPOINT	0x00000001	Read/write Web-based data provider list
LTXML	0x00000002	XML Mapper data
LTEXTTERNALDATA	0x00000003	External data source (query table) <180>

2.5.245 SQEIFlags

The **SQEIFlags** structure specifies additional undo data associated with a **natural language formula**.

0	1	2	3	4	5	6	7	8	9	10	11	12	13	14	15	16	17	18	19	20	21	22	23	24	25	26	27	28	29	30	31
cLoc																														A	B

cLoc (30 bits): An unsigned integer that specifies the number of elements in the **rgloc** field of the [Duce](#) structure that contains this structure. MUST be greater than or equal to 0x00000002 and less than or equal to 0x3FFFFFFF.

A - reserved (1 bit): MUST be zero, and MUST be ignored.

B - fRel (1 bit): A bit that specifies whether **relative references** are used.

2.5.246 SqRef

The **SqRef** structure specifies a sequence of [Ref8](#) structures on the **sheet**.

0	1	2	3	4	5	6	7	8	9	10	11	12	13	14	15	16	17	18	19	20	21	22	23	24	25	26	27	28	29	30	31
cref																rgrefs (variable)															
...																															

cref (2 bytes): An unsigned integer that specifies the number of elements in **rgrefs**. MUST be less than or equal to 0x2000.

rgrefs (variable): An array of [Ref8](#) structures. The number of elements in the array MUST be equal to **cref**.

2.5.247 SqRefU

The **SqRefU** structure specifies a sequence of [Ref8U](#) structures on the **sheet**.

0	1	2	3	4	5	6	7	8	9	10	11	12	13	14	15	16	17	18	19	20	21	22	23	24	25	26	27	28	29	30	31
cref																rgrefs (variable)															
...																															

cref (2 bytes): An unsigned integer that specifies the number of elements in **rgrefs**. MUST be less than or equal to 0x2000.

rgrefs (variable): An array of Ref8U structures. The number of elements in the array MUST be equal to **cref**.

2.5.248 Stxp

The **Stxp** structure specifies various formatting attributes of a **font**.

0	1	2	3	4	5	6	7	8	9	10	11	12	13	14	15	16	17	18	19	20	21	22	23	24	25	26	27	28	29	30	31
twpHeight																															
ts																															
bls																sss															
uls								bFamily								bCharSet								unused							

twpHeight (4 bytes): A signed integer that specifies the height of the font in **twips**. This value MUST be -1, 0, or between 20 and 8191. This value SHOULD NOT [<181>](#) be 0. A value of -1 specifies that this field is to be ignored.

ts (4 bytes): A [Ts](#) that specifies additional formatting attributes.

bls (2 bytes): A signed integer that specifies the font weight. This value MUST be 0, or a value from the following table. The value SHOULD NOT [<182>](#) be 0.

Value	Description
0xFFFF	Indicates that this specification is to be ignored
0x0190	Normal font weight
0x02BC	Bold font weight

sss (2 bytes): A signed integer that specifies whether the superscript or subscript or normal style of the font is used. MUST be set to a value from the following table:

Value	Description
0xFFFF	Indicates that this specification is to be ignored

Value	Description
0x0000	Normal script
0x0001	Superscript
0x0002	Subscript

uls (1 byte): An unsigned integer that specifies the underline style. The value MUST be one of the following:

Value	Description
0x00	No underline
0x01	Single
0x02	Double
0x21	single accounting
0x22	double accounting
0xFF	Indicates that this specification is to be ignored

bFamily (1 byte): An unsigned integer that specifies the **font family**, as defined by Windows API LOGFONT structure in [\[MSDN-FONTS\]](#). MUST be greater than or equal to 0 or less than or equal to 5.

bCharSet (1 byte): An unsigned integer that specifies the **character set**, as defined by Windows API LOGFONT structure in [\[MSDN-FONTS\]](#).

unused (1 byte): Undefined and MUST be ignored.

2.5.249 StyleXF

The **StyleXF** structure specifies formatting properties for a [cell style](#).

0	1	2	3	4	5	6	7	8	9	10	11	12	13	14	15	16	17	18	19	20	21	22	23	24	25	26	27	28	29	30	31
alc			A	alcV			B	trot						cIndent			C	D	E	unused											
dgLeft				dgRight				dgTop				F				icvLeft				icvRight				G							
icvTop						icvBottom						icvDiag						dgDiag		H	fls										
icvFore						icvBack						I																			

alc (3 bits): A [HorizAlign](#) that specifies the **horizontal alignment**.

A - fWrap (1 bit): A bit that specifies whether **cell** text is wrapped.

alcV (3 bits): A [VertAlign](#) that specifies the **vertical alignment**.

B - fJustLast (1 bit): A bit that specifies whether the justified or distributed alignment of the cell is used on the last line of text. (Setting this to 1 is typical for East Asian text but not typical in other contexts). If this field equals 1 then **alc** MUST equal 7.

trot (1 byte): An [XFPropTextRotation](#) that specifies the text rotation.

cIndent (4 bits): An unsigned integer that specifies the text **indentation level**. MUST be less than or equal to 15.

C - fShrinkToFit (1 bit): A bit that specifies whether a cell is **shrink to fit**.

D - reserved1 (1 bit): MUST be zero and MUST be ignored.

E - iReadOrder (2 bits): A [ReadingOrder](#) that specifies the **reading order**.

unused (1 byte): Undefined and MUST be ignored.

dgLeft (4 bits): A [BorderStyle](#) that specifies the **logical left border formatting**.

dgRight (4 bits): A [BorderStyle](#) that specifies the **logical right** border formatting.

dgTop (4 bits): A [BorderStyle](#) that specifies the top border formatting.

F - dgBottom (4 bits): A [BorderStyle](#) that specifies the bottom border formatting.

icvLeft (7 bits): An unsigned integer that specifies the color of the logical left **border**. The value MUST be one of the values specified in the **icv** field in [IcvXF](#) or zero. A value of zero means the left border color is not specified. If this value is zero then **dgLeft** MUST also be zero.

icvRight (7 bits): An unsigned integer that specifies the color of the logical right border. The value MUST be one of the values specified in the **icv** field in [IcvXF](#) or zero. A value of zero means the right border color is not specified. If this value is zero then **dgRight** MUST also be zero.

G - grbitDiag (2 bits): An unsigned integer that specifies which diagonal borders are present (if any). MUST be a value from the following table:

Value	Meaning
0x0	No diagonal border
0x1	Diagonal-down border
0x2	Diagonal-up border
0x3	Both diagonal-down and diagonal-up

icvTop (7 bits): An unsigned integer that specifies the color of the top border. The value MUST be one of the values specified in the **icv** field in [IcvXF](#) or zero. A value of zero means the top border color was not specified. If this value is zero then **dgTop** MUST also be zero.

icvBottom (7 bits): An unsigned integer that specifies the color of the bottom border. The value MUST be one of the values specified in the **icv** field in [IcvXF](#) or zero. A value of zero means the bottom border color was not specified. If this value is zero then **dgBottom** MUST also be zero.

icvDiag (7 bits): An unsigned integer that specifies the color of the diagonal border. The value MUST be one of the values specified in the **icv** field in [IcvXF](#) or zero. A value of zero means the diagonal border color has not been specified. If this value is zero then **dgDiag** MUST also be zero.

dgDiag (4 bits): A [BorderStyle](#) that specifies the diagonal border formatting.

H - reserved2 (1 bit): MUST be zero and MUST be ignored.

fls (6 bits): A [FillPattern](#) that specifies the **fill pattern**. If this value is 1 which specifies a solid fill pattern only **icvFore** is rendered.

icvFore (7 bits): An [IcvXF](#) that specifies the **foreground color** of the fill pattern.

icvBack (7 bits): An unsigned integer that specifies the **background color** of the fill pattern. The value **MUST** be an IcvXF value.

I - reserved3 (2 bits): **MUST** be zero and **MUST** be ignored.

2.5.250 SXAddI_SXDEnd

The **SXAddI_SXDEnd** record specifies the end of a sequence of [SXAddI](#) records that specify information about a [PivotTable](#).

0	1	2	3	4	5	6	7	8	9	10	11	12	13	14	15	16	17	18	19	20	21	22	23	24	25	26	27	28	29	30	31
hdr																															
...																reserved															
...																															

hdr (6 bytes): An [SXAddIHdr](#). The **sxd** field of SXAddIHdr **MUST** equal 0xFF.

reserved (6 bytes): **MUST** be zero, and **MUST** be ignored.

2.5.251 SXAddI_SXDVerUpdInv

The **SXAddI_SXDVerUpdInv** structure specifies the highest [data functionality level](#) for which records following this record are handled.

0	1	2	3	4	5	6	7	8	9	10	11	12	13	14	15	16	17	18	19	20	21	22	23	24	25	26	27	28	29	30	31
hdr																															
...																dwVersionInvalidates								reserved1							
reserved2																reserved3															

hdr (6 bytes): An [SXAddIHdr](#). The **sxd** field of SXAddIHdr **MUST** equal 0x01.

dwVersionInvalidates (1 byte): An unsigned integer that specifies the highest data functionality level for which records following this record are handled.

MUST be greater than or equal to 0 and less than or equal to 0xFF. If this value is equal to 0xFF, the data functionality level is not set.

reserved1 (1 byte): **MUST** be zero, and **MUST** be ignored.

reserved2 (2 bytes): **MUST** be zero, and **MUST** be ignored.

reserved3 (2 bytes): **MUST** be zero, and **MUST** be ignored.

2.5.252 SXAddI_SXString

The SXAddI_SXString structure specifies a Unicode string segment.

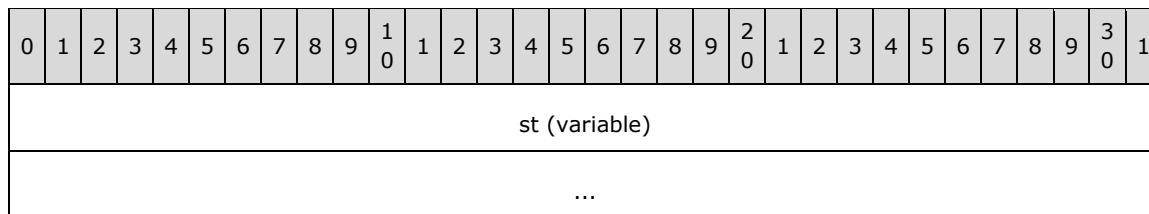

st (variable): An [XLUnicodeStringSegmentedSXADDL](#) that specifies a Unicode string segment. **st.cchTotal** MUST be less than or equal to 65535.

2.5.253 SXAddIHdr

The **SXAddIHdr** structure specifies header information for an [SXAddI](#) record.

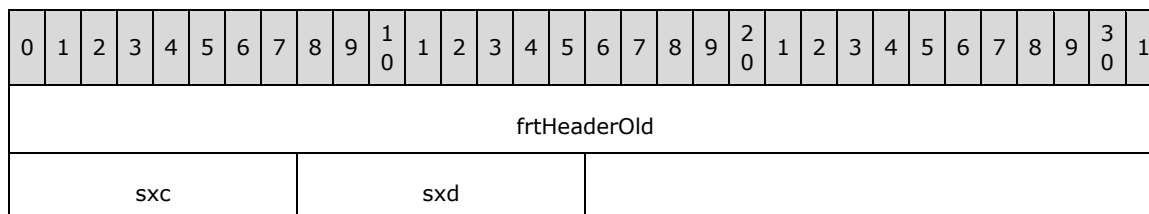

frtHeaderOld (4 bytes): An [FrtHeaderOld](#). The **frtHeaderOld.rt** field MUST be 0x0864.

sxc (1 byte): An unsigned integer that specifies the current class. See [class](#) for details.

sxd (1 byte): An unsigned integer that specifies the type of record contained in the **data** field of the containing SXAddI record. See [class](#) for details.

2.5.254 SXAxis

The **SXAxis** structure specifies the [PivotTable axis](#) referred to by the containing record.

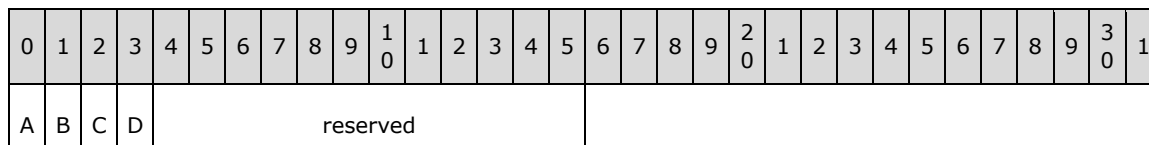

A - sxaxisRw (1 bit): A bit that specifies whether this structure refers to the [row axis](#).

B - sxaxisCol (1 bit): A bit that specifies whether this structure refers to the [column axis](#).

C - sxaxisPage (1 bit): A bit that specifies whether this structure refers to the [page axis](#).

D - sxaxisData (1 bit): A bit that specifies whether this structure refers to the [value axis](#).

reserved (12 bits): MUST be zero, and MUST be ignored.

2.5.255 SXEZDoper

The **SXEZDoper** structure specifies a [PivotTable](#) data operation.

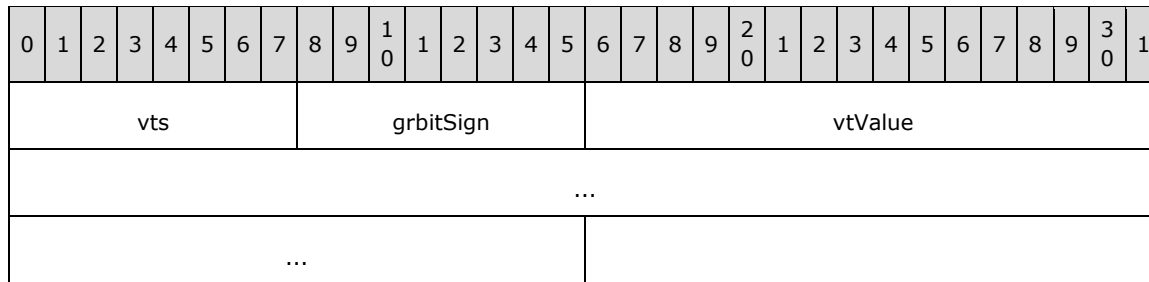

vts (1 byte): An unsigned integer that specifies the type of comparison used in the data operation. MUST be a value in the following table:

Value	Meaning
0x00	This SXEZOoper record is undefined and MUST be ignored.
0x04	This SXEZOoper specifies a numeric data operation.
0x06	This SXEZOoper specifies a string data operation.
0x0C	This SXEZOoper specifies that all space characters are matched in the data operation.
0x0E	This SXEZOoper specifies that all non-space characters are matched in the data operation.

grbitSign (1 byte): An unsigned integer that specifies the comparison operation between a database value and **vtValue**. MUST be one of the following values:

Value	Meaning
0x00	No operation. The vts field MUST be zero.
0x01	Less than
0x02	Equal to
0x03	Less than or equal to
0x04	Greater than
0x05	Not equal to
0x06	Greater than or equal to

vtValue (8 bytes): A field with the type and meaning specified by the value of **vts**, as specified in the following table:

Value of vts	vtValue meaning
0x00	Undefined and MUST be ignored.
0x04	An Xnum (section 2.5.342) that specifies the numeric value used in the numeric data operation.
0x06	A PivotCompProp that specifies the type of string comparison.
0x0C	Undefined and MUST be ignored.
0x0E	Undefined and MUST be ignored.

2.5.256 SxFT

The **SxFT** structure specifies the pivot filter types.

Name	Value	Meaning
SXFTCOUNT	0x00000001	Specifies the "count" filter. This is a value filter .
SXFTPERCENT	0x00000002	Specifies the "percent" filter. This is a value filter.
SXFTSUM	0x00000003	Specifies the "sum" filter. This is a value filter.
SXFTCAPTIONEQUALS	0x00000004	Specifies the "equals" filter. This is a label filter .
SXFTCAPTIONDOESNOTEQUAL	0x00000005	Specifies the "not equal" filter. This is a label filter.
SXFTCAPTIONBEGINSWITH	0x00000006	Specifies the "begins with" filter. This is a label filter.
SXFTCAPTIONDOESNOTBEGINWITH	0x00000007	Specifies the "does not begin with" filter. This is a label filter.
SXFTCAPTIONENDSWITH	0x00000008	Specifies the "ends with" filter. This is a label filter.
SXFTCAPTIONDOESNOTENDWITH	0x00000009	Specifies the "does not end with" filter. This is a label filter.
SXFTCAPTIONCONTAINS	0x0000000A	Specifies the "contains" filter. This is a label filter.
SXFTCAPTIONDOESNOTCONTAIN	0x0000000B	Specifies the "does not contain" filter. This is a label filter.
SXFTCAPTIONISGREATERTHAN	0x0000000C	Specifies the "is greater than" filter. This is a label filter.
SXFTCAPTIONISGREATERTHANOREQUALTO	0x0000000D	Specifies the "is greater than or equal to" filter. This is a label filter.
SXFTCAPTIONISLESSTHAN	0x0000000E	Specifies the "is less than" filter for field captions. This is a label filter.
SXFTCAPTIONISLESSTHANOREQUALTO	0x0000000F	Specifies the "is less than or equal to" filter. This is a label filter.
SXFTCAPTIONISBETWEEN	0x00000010	Specifies the "is between" filter. This is a label filter.
SXFTCAPTIONISNOTBETWEEN	0x00000011	Specifies the "is not between" filter. This is a label filter.
SXFTVALUEEQUAL	0x00000012	Specifies the "value equal" filter. This is a value filter.
SXFTVALUENOTEQUAL	0x00000013	Specifies the "value not equal" filter. This is a value filter.
SXFTVALUEGREATERTHAN	0x00000014	Specifies the "value greater than" filter. This is a value filter.
SXFTVALUEGREATERTHANOREQUAL	0x00000015	Specifies the "value greater than or equal to" filter. This is a value filter.
SXFTVALUELESSTHAN	0x00000016	Specifies the "value less than" filter. This is a

Name	Value	Meaning
		value filter.
SXFTVALUELESSTHANOREQUAL	0x00000017	Specifies the "value less than or equal to" filter. This is a value filter.
SXFTVALUEBETWEEN	0x00000018	Specifies the "value between" filter. This is a value filter.
SXFTVALUENOTBETWEEN	0x00000019	Specifies the "value not between" filter. This is a value filter.
SXFTDATEEQUALS	0x0000001A	Specifies the "equals" filter. This is a date filter .
SXFTDATEOLDERTHAN	0x0000001B	Specifies the "older than" filter. This is a date filter.
SXFTDATENEWERTHAN	0x0000001C	Specifies the "newer than" filter. This is a date filter.
SXFTDATEBETWEEN	0x0000001D	Specifies the "between" filter. This is a date filter.
SXFTDATETOMORROW	0x0000001E	Specifies the "tomorrow" filter. This is a date filter.
SXFTDATETODAY	0x0000001F	Specifies the "today" filter. This is a date filter.
SXFTDATEYESTERDAY	0x00000020	Specifies the "yesterday" filter. This is a date filter.
SXFTDATENEXTWEEK	0x00000021	Specifies the "next week" filter. This is a date filter.
SXFTDATETHISWEEK	0x00000022	Specifies the "this week" filter. This is a date filter.
SXFTDATELASTWEEK	0x00000023	Specifies the "last week" filter. This is a date filter.
SXFTDATENEXTMONTH	0x00000024	Specifies the "next month" filter. This is a date filter.
SXFTDATETHISMONTH	0x00000025	Specifies the "this month" filter. This is a date filter.
SXFTDATELASTMONTH	0x00000026	Specifies the "last month" filter. This is a date filter.
SXFTDATENEXTQUARTER	0x00000027	Specifies the "next quarter" filter. This is a date filter.
SXFTDATETHISQUARTER	0x00000028	Specifies the "this quarter" filter. This is a date filter.
SXFTDATELASTQUARTER	0x00000029	Specifies the "last quarter" filter. This is a date filter.
SXFTDATENEXTYEAR	0x0000002A	Specifies the "next year" filter. This is a date filter.
SXFTDATETHISYEAR	0x0000002B	Specifies the "this year" filter. This is a date filter.

Name	Value	Meaning
SXFTDATELASTYEAR	0x0000002C	Specifies the "last year" filter. This is a date filter.
SXFTDATEYEARTODATE	0x0000002D	Specifies the "year-to-date" filter. This is a date filter.
SXFTDATEALLDATESINPERIODQUARTER1	0x0000002E	Specifies the "first quarter" filter. This is a date filter.
SXFTDATEALLDATESINPERIODQUARTER2	0x0000002F	Specifies the "second quarter" filter. This is a date filter.
SXFTDATEALLDATESINPERIODQUARTER3	0x00000030	Specifies the "third quarter" filter. This is a date filter.
SXFTDATEALLDATESINPERIODQUARTER4	0x00000031	Specifies the "fourth quarter" filter. This is a date filter.
SXFTDATEALLDATESINPERIODJANUARY	0x00000032	Specifies the "January" filter. This is a date filter.
SXFTDATEALLDATESINPERIODFEBRUARY	0x00000033	Specifies the "February" filter. This is a date filter.
SXFTDATEALLDATESINPERIODMARCH	0x00000034	Specifies the "March" filter. This is a date filter.
SXFTDATEALLDATESINPERIODAPRIL	0x00000035	Specifies the "April" filter. This is a date filter.
SXFTDATEALLDATESINPERIODMAY	0x00000036	Specifies the "May" filter. This is a date filter.
SXFTDATEALLDATESINPERIODJUNE	0x00000037	Specifies the "June" filter. This is a date filter.
SXFTDATEALLDATESINPERIODJULY	0x00000038	Specifies the "July" filter. This is a date filter.
SXFTDATEALLDATESINPERIODAUGUST	0x00000039	Specifies the "August" filter. This is a date filter.
SXFTDATEALLDATESINPERIODSEPTEMBER	0x0000003A	Specifies the "September" filter. This is a date filter.
SXFTDATEALLDATESINPERIODOCTOBER	0x0000003B	Specifies the "October" filter. This is a date filter.
SXFTDATEALLDATESINPERIODNOVEMBER	0x0000003C	Specifies the "November" filter. This is a date filter.
SXFTDATEALLDATESINPERIODDECEMBER	0x0000003D	Specifies the "December" filter. This is a date filter.
SXFTDATENOTEQUAL	0x0000003E	Specifies the "not equal" filter. This is a date filter.
SXFTDATEOLDEROREQUAL	0x0000003F	Specifies the "older than or equal to" filter. This is a date filter.
SXFTDATENEWEROREQUAL	0x00000040	Specifies the "newer than or equal to" filter. This is a date filter.
SXFTDATENOTBETWEEN	0x00000041	Specifies the "not between" filter. This is a date filter.

2.5.257 SxIvdCol

The **SxIvdCol** structure specifies a reference to a [pivot field](#) or [data field](#) on the [column axis](#)

0	1	2	3	4	5	6	7	8	9	10	11	12	13	14	15	16	17	18	19	20	21	22	23	24	25	26	27	28	29	30	31
col																															

col (2 bytes): A signed integer that specifies a pivot field or data field for the column axis of the [PivotTable view](#). MUST be a value from the following table:

Value	Meaning
-2	This value specifies that the data field is on the column axis. The sxaxisCol field of sxaxis4Data of the SxView record of the PivotTable view MUST equal 1 and the sxaxisData field of sxaxis4Data of the SxView record of the PivotTable view MUST equal zero.
0+	This value specifies a pivot field index as specified in Pivot Fields. The pivot field index specifies a pivot field on the column axis of the PivotTable view. MUST be less than the cDim field of the SxView record of the PivotTable view. If the referenced pivot field is not a hidden field in an OLAP PivotTable view then the sxaxisCol field of SXAxis of the Sxvd record of the pivot field MUST equal 1.

A pivot field is a hidden field if an [SXAddl_SXCField12_SXDVer12Info](#) record exists for the pivot field, and the **fHiddenLvl** field of the [SXAddl_SXCField12_SXDVer12Info](#) record is 1.

2.5.258 SxIvdRw

The **SxIvdRw** structure specifies a reference to a [pivot field](#) or [data field](#) on the [row axis](#).

0	1	2	3	4	5	6	7	8	9	10	11	12	13	14	15	16	17	18	19	20	21	22	23	24	25	26	27	28	29	30	31
rw																															

rw (2 bytes): A signed integer that specifies a pivot field or data field for the row axis of the [PivotTable view](#). MUST be a value from the following table:

Value	Meaning
-2	This value specifies that the data field is on the row axis. The sxaxisRw field of sxaxis4Data of SxView record of the PivotTable view MUST equal 1 and the sxaxisData field of sxaxis4Data of the SxView record of the PivotTable view MUST equal zero.
0+	This value specifies a pivot field index as specified in Pivot Fields. The pivot field index specifies a pivot field on the row axis of the PivotTable view. MUST be less than the cDim field of the SxView record of the PivotTable view. If the referenced pivot field is not a hidden field in an OLAP PivotTable view then the sxaxisRw field of SXAxis of the Sxvd record of the pivot field MUST equal 1.

A pivot field is a hidden field if an [SXAddl_SXCField12_SXDVer12Info](#) record exists for the pivot field, and the **fHiddenLvl** field of the [SXAddl_SXCField12_SXDVer12Info](#) record is 1.

2.5.259 SXLIItem

The **SXLIItem** structure specifies a [pivot line](#) in the [row area](#) or [column area](#) of a [PivotTable view](#).

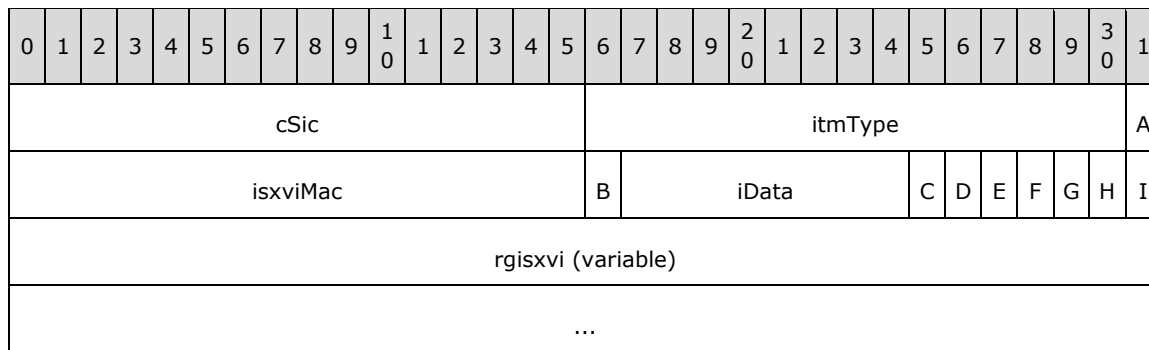

cSic (2 bytes): A signed integer that specifies the count of [pivot item](#) indexes in the beginning of the **rgisxvi** array that are identical to the same number of pivot item indexes in the beginning of the **rgisxvi** array of the previous SXLIItem structure in the **rgsxli** array of the preceding [SXLI](#) record. The value **MUST** be greater than or equal to 0 and less than the **isxviMac** field. If the **fGrand** field equals 1, then this value **MUST** be 0.

itmType (15 bits): An unsigned integer that specifies the type of this pivot line. **MUST** be a value from the following table:

Name	Value	Meaning
ITMTYPEDATA	0x0000	A value in the data
ITMTYPEDEFAULT	0x0001	Automatic subtotal selection
ITMTYPESUM	0x0002	Sum of values in the data
ITMTYPECOUNTA	0x0003	Count of values in the data
ITMTYPECOUNT	0x0004	Count of numbers in the data
ITMTYPEAVERAGE	0x0005	Average of values in the data
ITMTYPEMAX	0x0006	Maximum value in the data
ITMTYPEMIN	0x0007	Minimum value in the data
ITMTYPEPRODUCT	0x0008	Product of values in the data
ITMTYPESTDDEV	0x0009	Statistical standard deviation (estimate)
ITMTYPESTDDEVP	0x000A	Statistical standard deviation (entire population)
ITMTYPEVAR	0x000B	Statistical variance (estimate)
ITMTYPEVARP	0x000C	Statistical variance (entire population)
ITMTYPEGRAND	0x000D	Grand total
ITMTYPEBLANK	0x000E	Blank line

A - reserved1 (1 bit): **MUST** be zero and **MUST** be ignored.

isxviMac (2 bytes): A signed integer that specifies the number of elements in the **rgisxvi** array that are displayed in this pivot line. **MUST** be greater than or equal to 0. If the **fGrand** field equals 1, then the value of this field **MUST** be 1. If the **fGrand** field equals zero and the preceding SXLI record contains row area pivot items, then this value **MUST** be less than or equal to the **cDimRw** field of the preceding [SxView](#). If the **fGrand** field equals zero and the preceding SXLI record contains column area pivot items, then this value **MUST** be less than or equal to the **cDimCol** field of the preceding [SxView](#).

B - fMultiDataName (1 bit): A bit that specifies whether the [data field](#) name is used for the total or the subtotal. **MUST** be a value from the following table:

Value	Meaning
0	The data field name is used for the total.

Value	Meaning
1	The data field name is used for the subtotal.

If the **fGrand** field equals 1 or the **fBlock** field equals 1, then this value MUST equal the value in the **fMultiDataOnAxis** field. If the **fGrand** and **fBlock** fields equal zero, the **fSbt** and **fMultiDataOnAxis** fields equal 1, and the **cSic** field is less than *iposData*, then this value MUST equal 1. Otherwise, this value MUST be 0.

iposData is specified as follows:

- If the preceding SXLI record contains row area pivot items, *iposData* equals the index of the [SxIvdRw](#) record in the **rgSxivd** array of the [SxIvd](#) containing SxIvdRw records where the **rw** field equals -2. If there is not an SxIvdRw record with the **rw** field equal to -2, *iposData* equals zero.
- If the preceding SXLI record contains column area pivot items, *iposData* equals the index of the [SxIvdCol](#) record in the **rgSxivd** array of the SxIvd containing SxIvdCol records where the **col** field equals -2. If there is not an SxIvdCol record with the **col** field equal to -2, *iposData* equals zero.

iData (8 bits): An unsigned integer that specifies a [data item](#) index as specified in Data Items, for an [SXDI](#) record specifying a data item used for a subtotal. This field MUST be 0 if the **cDimData** field of the preceding SxView record is 0 or if the **fGrand** field equals 1. If the **cDimData** field of the preceding SxView is greater than 0, then this value MUST be greater than or equal to 0 and less than the **cDimData** field of the preceding SxView record. If the **fMultiDataOnAxis** field equals 1 and the **itmType** field does not equal ITMTYPEBLANK and the **isxviMac** field is greater than *iposData* as specified in **fMultiDataName**, then the value of this field MUST equal the value of the element of the **rgisxvi** array in the position equal to *iposData* as specified in **fMultiDataName**.

C - fSbt (1 bit): A bit that specifies whether this pivot line is a subtotal. This value MUST equal 1 if the **itmType** field is greater than or equal to ITMTYPEDEFAULT and the **itmType** field is less than or equal to ITMTYPEGRAND and the **fBlock** field equals 0. Otherwise, this value MUST be 0.

D - fBlock (1 bit): A bit that specifies whether this pivot line is a block total. A block total is a total of a group of pivot items. For more details see [Grouping](#). If the **fGrand** field equals 0 and the **fBlock** field in the previous SXLIItem record equals 1, this value MUST be 1.

E - fGrand (1 bit): A bit that specifies whether this pivot line is a **grand total**. If the **fGrand** field in the previous SXLIItem record is 1, then this value MUST be 1. Otherwise, if the **itmType** field equals ITMTYPEGRAND this field MUST equal 1 and if the **itmType** field does not equal ITMTYPEGRAND this field MUST equal 0.

F - fMultiDataOnAxis (1 bit): A bit that specifies whether a [pivot line entry](#) in this pivot line is a data item index.

If the preceding SXLI record contains row area pivot items, the **cDimData** field of the preceding SxView record is greater than 1, the **sxaxis4Data.sxaxisRw** field of the preceding SxView equals 1 and **itmType** is not equal to ITMTYPEBLANK, then this value MUST be 1. Otherwise, this value MUST be 0.

If the preceding SXLI record contains column area pivot items, the **cDimData** field of the preceding SxView record is greater than 1, the **sxaxis4Data.sxaxisCol** field of the preceding SxView equals 1 and **itmType** is not equal to ITMTYPEBLANK, then this value MUST be 1. Otherwise, this value MUST be 0.

G - unused1 (1 bit): Undefined, and MUST be ignored.

H - unused2 (1 bit): Undefined, and MUST be ignored.

I - reserved2 (1 bit): MUST be zero and MUST be ignored.

rgisxvi (variable): An array of 2-byte signed integers that specifies a pivot line entry.

Each element of this array is either a pivot item index or a data item index.

If **fGrand** is 1 or **itmType** is ITMTYPEBLANK then all elements of this field are undefined and MUST be ignored. Otherwise each element MUST be a value from the following table:

Value	Meaning
0x0000 to 0x7EF4	This value specifies a data item index or pivot item index in the associated pivot field as specified in Pivot Items.
0x7FFF	This value specifies that there is no pivot item and that the cell in the pivot line is blank.

For more details see Pivot Line Entries and Pivot Lines.

2.5.260 SXPI_Item

The **SXPI_Item** structure specifies information about a [pivot field](#) and its filtering on the [page axis](#) of a [PivotTable view](#).

0	1	2	3	4	5	6	7	8	9	10	11	12	13	14	15	16	17	18	19	20	21	22	23	24	25	26	27	28	29	30	31
isxvd																isxvi															
idObj																															

isxvd (2 bytes): A signed integer that specifies a pivot field index as specified by Pivot Fields. The referenced pivot field is specified to be on the page axis. MUST be greater than or equal to zero and less than the **cDim** field of the [SxView](#) record of the PivotTable view.

isxvi (2 bytes): A signed integer that specifies the [pivot item](#) used for the page axis filtering. MUST be a value from the following table:

Value	Meaning
0x0000 to 0x7FFC	This value specifies a pivot item index that specifies a pivot item in the pivot field specified by isxvd . The referenced pivot item specifies the page axis filtering for the pivot field.
0x7FFD	This value specifies all pivot items, see page axis for filtering that applies.

For a non-[OLAP PivotTable view](#) the value MUST be 0x7FFD or greater than or equal to zero and less than the **cItm** field of the [Sxvd](#) record of the pivot field. Otherwise the value MUST be 0x7FFD.

idObj (2 bytes): A signed integer that specifies the object identifier of the [Obj](#) record with the page item drop-down arrow.

2.5.261 SXVDEx_Opt

The **SXVDEx_Opt** structure specifies an optional string in the [SXVDEx](#) record.

0	1	2	3	4	5	6	7	8	9	10	11	12	13	14	15	16	17	18	19	20	21	22	23	24	25	26	27	28	29	30	31
cchSubName																reserved1															
...																reserved2															

...	stSubName (variable)
...	

cchSubName (2 bytes): An unsigned integer that specifies the length, in characters, of the [XLUnicodeStringNoCch](#) in the **stSubName** field. If the value is 0xFFFF then **stSubName** does not exist. The value MUST be 0xFFFF or greater than zero and less than or equal to 0x00FF.

reserved1 (4 bytes): MUST be zero, and MUST be ignored.

reserved2 (4 bytes): MUST be zero, and MUST be ignored.

stSubName (variable): An XLUnicodeStringNoCch that specifies the name of the aggregate function used to calculate this [pivot field](#)'s subtotals. A "?" character within the string will be replaced by the **stName** field of [Sxvd](#) when displayed in the UI. The length is specified in **cchSubName**.

2.5.262 SXView9Save

The **SXView9Save** structure specifies option flags for a [PivotTable view](#).

0	1	2	3	4	5	6	7	8	9	10	11	12	13	14	15	16	17	18	19	20	21	22	23	24	25	26	27	28	29	30	31
A	B	C	D	E	reserved2											reserved3															

A - fNoStencil (1 bit): A bit that specifies whether to disable the drawing of large drop zones for a PivotTable view that has no data fields.

B - fHideTotAnnotation (1 bit): A bit that specifies whether, for an [OLAP PivotTable view](#) when the **fNotVisualTotals** field of the [SXAddl_SXCView_SXDVer12Info](#) record of the PivotTable view is 0 or the SXAddl_SXCView_SXDVer12Info record is not present, an asterisk is not displayed next to the caption for subtotals and grand totals.

C - reserved1 (1 bit): MUST be zero, and MUST be ignored.

D - fIncludeEmptyRw (1 bit): A bit that specifies whether empty rows from an **OLAP data source** be shown in the PivotTable view.

E - fIncludeEmptyCol (1 bit): A bit that specifies whether empty columns from an OLAP data source is shown in the PivotTable view.

reserved2 (11 bits): MUST be zero, and MUST be ignored.

reserved3 (16 bits): MUST be zero, and MUST be ignored.

2.5.263 SXVIFlags

SXVIFlags is a 2-byte structure which specifies properties for a [pivot item](#).

0	1	2	3	4	5	6	7	8	9	10	11	12	13	14	15	16	17	18	19	20	21	22	23	24	25	26	27	28	29	30	31
A	B	C	D	E	F	reserved2																									

A - fDrilledMember (1 bit): A bit that specifies whether child elements of this node are collapsed, see [Collapsing](#) for details. MUST be zero if the pivot items are from **attribute hierarchies**. MUST be zero if the **itmType** field of the [SXVI](#) record of the pivot item is not zero.

B - reserved1 (1 bit): MUST be zero, and MUST be ignored.

C - fHasChildren (1 bit): A bit that specifies whether the pivot item has child **OLAP members**. MUST be zero if the **itmType** field of the SXVI record of the pivot item is not zero.

D - fCollapsedMember (1 bit): A bit that specifies whether the subnodes of this node are collapsed, see [Collapsing](#) for details. This value applies only to pivot items of attribute hierarchies. MUST be zero if the pivot items are from non-attribute hierarchies.

E - fHasChildrenEst (1 bit): A bit that specifies whether **fHasChildren** is considered correct.

F - fOlapFilterSelected (1 bit): A bit that specifies whether this pivot item is selected for [Olap Manual Filtering](#).

reserved2 (10 bits): MUST be zero, and MUST be ignored.

2.5.264 TabId

The **TabId** structure specifies the unique sheet identifier associated with the **sheet**. A sheet's identifier is specified by the [RRTabId](#) record, the order of the sheet identifiers in the RRTabId record matches the order of the [BoundSheet8](#) records as they appear in the [Globals Substream](#). If the **workbook** contains more than 4112 sheets then this record is not present and each sheet identifier is specified by the order in which the BoundSheet8 records appear in the Globals Substream, beginning with one.

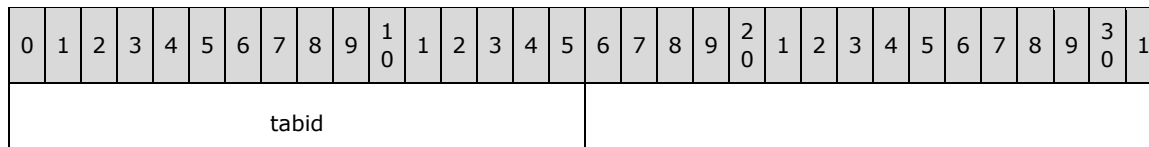

tabid (2 bytes): An unsigned integer that specifies the unique sheet identifier associated with the sheet. MUST be greater than or equal to 0x0001 and less than or equal to 0xFFFFE.

2.5.265 TabIndex

The **TabIndex** structure specifies a **sheet** index in the **workbook**. A sheet index is the zero-based index into the collection of [BoundSheet8](#) records as they appear in the [Globals Substream](#)

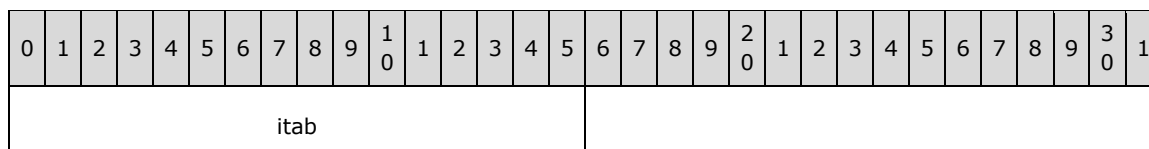

itab (2 bytes): An unsigned integer that specifies the zero-based index into the collection of BoundSheet8 records as they appear in the Globals Substream.

2.5.266 TableFeatureType

The **TableFeatureType** structure specifies the definition of a **table** within a **sheet**.

The table feature supports multiple **data source** types. The data source is specified by the **It** field. If the **It** field is 0x00000001, the table's data source definition is cached within the [List Data](#) stream. If

the **It** field is 0x00000002, the table's data source schema is cached within the **XML stream** (section [2.1.7.22](#)).

0	1	2	3	4	5	6	7	8	9	10	11	12	13	14	15	16	17	18	19	20	21	22	23	24	25	26	27	28	29	30	31	
It																																
idList																																
crwHeader																																
crwTotals																																
idFieldNext																																
cbFSDData																																
rupBuild																unused1																
A	B	C	D	E	F	G	H	I	J	K	L	M	N	O	P	verXL	Q	R	S	T	U	reserved3										
IPosStmCache																																
cbStmCache																																
cchStmCache																																
lem																																
rgbHashParam (16 bytes)																																
...																																
...																																
rgbName (variable)																																
...																																
cFieldData																cSPName (variable)																
...																																
entryId (variable)																																
...																																
fieldData (variable)																																

...
idDeleted (variable)
...
idChanged (variable)
...
cellInvalid (variable)
...

It (4 bytes): A [SourceType](#) that specifies the type of data source for the table.

idList (4 bytes): An unsigned integer that specifies an identifier for the table. MUST be unique within the sheet. SHOULD [<183>](#) be unique within the **workbook**.

crwHeader (4 bytes): A Boolean (section [2.5.14](#)) that specifies whether the table has a **header row**. If **fAutoFilter** is 1, the value MUST be 0x00000001. If **fSingleCell** is 1, the value MUST be 0x00000000. MUST be one of the following values:

Value	Meaning
0x00000000	Table has no header row.
0x00000001	Table has a header row.

crwTotals (4 bytes): A Boolean that specifies whether there is a **total row**. If **fSingleCell** is 1, the value MUST be 0x00000000. MUST be one of the following values:

Value	Meaning
0x00000000	Table has no total row.
0x00000001	Table has a total row.

idFieldNext (4 bytes): An unsigned integer that specifies the next unique identifier to use when assigning unique identifiers to the **fieldData.idField** field of the table.

cbFSDData (4 bytes): An unsigned integer that specifies the size, in bytes, of the fixed portion of this structure. The fixed portion starts at the **It** field and ends at the **rgbHashParam** field. MUST be equal to 64.

rupBuild (2 bytes): An unsigned integer that specifies the **build number** of the application that wrote the structure.

unused1 (2 bytes): Undefined, and MUST be ignored.

A - unused2 (1 bit): Undefined, and MUST be ignored.

B - fAutoFilter (1 bit): A bit that specifies whether the table has an **AutoFilter**. MUST be 1 when **fPersistAutoFilter** is 1.

C - fPersistAutoFilter (1 bit): A bit that specifies whether the AutoFilter is preserved for this table after data **refresh** operations. [<184>](#)

D - fShowInsertRow (1 bit): A bit that specifies whether the **insert row** is **visible**. MUST be 1 if **fInsertRowInsCells** is 1.

E - fInsertRowInsCells (1 bit): A bit that specifies whether rows below the table are shifted down because of the insert row being visible.

F - fLoadPldwIdDeleted (1 bit): A bit that specifies whether the **idDeleted** field is present. MUST be zero if the **It** field is not set to 0x00000001.

G - fShownTotalRow (1 bit): A bit that specifies whether the total row was ever visible.

H - reserved1 (1 bit): MUST be zero and MUST be ignored.

I - fNeedsCommit (1 bit): A bit that specifies whether table modifications were not synchronized with the data source. MUST be zero if the **It** field is not set to 0x00000001.

J - fSingleCell (1 bit): A bit that specifies whether the table is limited to a single **cell**. The table cannot have header rows, total rows, or multiple columns. If **fSingleCell** equals 1, the **It** field MUST be set to 0x00000002.

K - reserved2 (1 bit): MUST be zero and MUST be ignored.

L - fApplyAutoFilter (1 bit): A bit that specifies whether the AutoFilter is currently applied. MUST be 1 if the AutoFilter is currently applied [<185>](#).

M - fForceInsertToBeVis (1 bit): A bit that specifies whether the insert row is forced to be visible because the table has no data.

N - fCompressedXml (1 bit): A bit that specifies whether the cached data for this table in the List Data stream is compressed. MUST be zero if the **It** field is not set to 0x00000001.

O - fLoadCSPName (1 bit): A bit that specifies whether the **cSPName** field is present. MUST be zero if the **It** field is not set to 0x00000001.

P - fLoadPldwIdChanged (1 bit): A bit that specifies whether **idChanged** field is present. MUST be zero if the **It** field is not set to 0x00000001.

verXL (4 bits): An unsigned integer that specifies the application version under which the table was created. MUST be either 0xB or 0xC [<186>](#).

Q - fLoadEntryId (1 bit): A bit that specifies whether the **entryId** field is present.

R - fLoadPllstclInvalid (1 bit): A bit that specifies whether the **cellInvalid** field is present. MUST be zero if the **It** field is not set to 0x00000001.

S - fGoodRupBld (1 bit): A bit that specifies whether the **rupBuild** field is valid.

T - unused3 (1 bit): Undefined, and MUST be ignored.

U - fPublished (1 bit): A bit that specifies whether the table is **published**. This bit is ignored if the **fPublishedBookItems** field of the [BookExt_Conditional12](#) structure is zero.

reserved3 (7 bits): Undefined, and MUST be ignored.

IPosStmCache (4 bytes): An unsigned integer that specifies the position of the cached data within the List Data stream. Undefined and MUST be ignored if the **It** field is not set to 0x00000001.

cbStmCache (4 bytes): An unsigned integer that specifies the size, in bytes, of the cached data within the List Data stream. Undefined and MUST be ignored if the **It** field is not set to 0x00000001.

cchStmCache (4 bytes): An unsigned integer that specifies the count of characters of the cached data within the List Data stream when the cached data is uncompressed. Undefined and MUST be ignored if the **It** field is not set to 0x00000001.

lem (4 bytes): A [LEMMode](#) enumeration that specifies the table edit mode. If **It** is set to 0x00000000, 0x00000002 or 0x00000003, this field MUST be set to 0x00000000.

rgbHashParam (16 bytes): An array of bytes that specifies round-trip information. SHOULD<187> be ignored and MUST be preserved if the **It** field is set to 0x00000001. Undefined and MUST be ignored if the **It** field is not set to 0x00000001.

rgbName (variable): An [XLUnicodeString](#) that specifies the name of the table. MUST be unique per [workbook](#), and case-sensitive in all locales.

cFieldData (2 bytes): An unsigned integer that specifies the number of columns in the table. MUST be greater than or equal to 0x0001 and less than or equal to 0x0100.

cSPName (variable): An [XLUnicodeString](#) that specifies the name of the **cryptographic service provider** used to specify **rgbHashParam**. This field is present only if **fLoadCSPName** is set to 1.

entryId (variable): An [XLUnicodeString](#) that specifies a unique identifier for the table. The string equals the value of the **idList** field, represented in decimal format, without any leading zeros. It is used when **It** equals 0x00000002 and ignored otherwise. This field is present only if **fLoadEntryId** is set to 1.

fieldData (variable): An array of [Feat11FieldDataItem](#) that contains the specification of the columns of the table. The number of items in this array is specified by the **cFieldData** field.

idDeleted (variable): A [Feat11RgSharepointIdDel](#) structure that specifies the identifiers of deleted rows. This information is used when synchronizing with the Web based **data provider's** data source. This field is only present if the **fLoadPldwIdDeleted** field is set to 1.

idChanged (variable): A [Feat11RgSharepointIdChange](#) structure that specifies the identifiers of the edited rows. This information is used when synchronizing with the Web based data provider's data source. This field is only present if the **fLoadPldwIdChanged** field is set to 1.

cellInvalid (variable): A [Feat11RgInvalidCells](#) structure that specifies the location of cells within the table that contain values that are invalid based on validation rules on the Web based data provider. This field is only present if the **fLoadPllstclInvalid** field is set to 1.

2.5.267 Tag_Fn_MDX

The **Tag_Fn_MDX** enumeration specifies **cube function** types.

Name	Value	Meaning
TFNCUBEMEMBER	0x01	CUBEMEMBER
TFNCUBEVALUE	0x02	CUBEVALUE
TFNCUBESET	0x03	CUBESET
TFNCUBESETCOUNT	0x04	CUBESETCOUNT
TFNCUBERANKEDMEMBER	0x05	CUBERANKEDMEMBER
TFNCUBEMEMBERPROPERTY	0x06	CUBEMEMBERPROPERTY

Name	Value	Meaning
TFNCUBEKPIPPROPERTY	0x07	CUBEKPIPPROPERTY

2.5.268 TextPropsStreamChecksumData

The **TextPropsStreamChecksumData** structure specifies the data used to compute the **checksum** of the **TextPropsStream** record. This data can be obtained from **Font** and **Text** records associated with the **TextPropsStream** record, as specified in **TextPropsStream**. If no **Font** record is associated with the **TextPropsStream** record, the fields related to the **Font** record **MUST** be omitted from this structure and thus not used to compute the checksum. If no **Text** record is associated with the **TextPropsStream** record, the **Text** record associated with the **DefaultText** record **MUST** be used instead.

0	1	2	3	4	5	6	7	8	9	10	11	12	13	14	15	16	17	18	19	20	21	22	23	24	25	26	27	28	29	30	31
stFontName (variable)																															
...																															
dwFontHeight																															
A	B	C	D	E	F	G	H	I	J	K	unused1					boldness															
subscript											bUnderline										bFamily										
bCharset										unused2												rgbFontColor									
...											dwDrawingMode																				
...											bRotation										dwHAlignment										
...											dwVAlignment																				
...											bReadingOrder																				

stFontName (variable): An array of **Unicode** characters that specify the **font** name. The size of the array **MUST** be equal to **fontName.cch*2**, where **fontName** is a field of the associated **Font** record.

The value of this field **MUST** be equal to value of the **fontName.rgb** field of the associated **Font** record.

dwFontHeight (4 bytes): An unsigned integer that specifies the font height. The value of this field **MUST** be equal to the value of the **dyHeight** field of the associated **Font** record.

A - fBold (1 bit): A bit that specifies whether the font is bold. The value of this field **MUST** be 1 when the value of the **bls** field of the associated **Font** record is greater than 400.

B - fItalic (1 bit): A bit that specifies whether the font is italic. The value of this field **MUST** be equal to the value of the **fItalic** field of the associated **Font** record.

C - fUnderline (1 bit): A bit that specifies whether the font is single-underlined. The value of this field **MUST** be 1 when the value of the **uls** field of the associated **Font** record is not equal to 0x00.

- D - fOutline (1 bit):** A bit that specifies whether the font has an **outline effect** applied. The value of this field MUST be equal to the value of the **fOutline** field of the associated Font record.
- E - fShadow (1 bit):** A bit that specifies whether the font has a **shadow effect** applied. The value of this field MUST be equal to the value of the **fShadow** field of the associated Font record.
- F - fCondense (1 bit):** A bit that specifies whether the font is condensed. The value of this field MUST be equal to the value of the **fCondense** field of the associated Font record.
- G - fExtend (1 bit):** A bit that specifies whether the font is extended. The value of this field MUST be equal to the value of the **fExtend** field of the associated Font record.
- H - fStrikeout (1 bit):** A bit that specifies whether the font has strike-through effect applied. The value of this field MUST be equal to the value of the **fStrikeOut** field of the associated Font record.
- I - fRegular (1 bit):** A bit that specifies whether the font is a regular font. The value of this field MUST be equal to 1.
- J - fJon (1 bit):** A bit that specifies whether the font is too small to be displayed. MUST have a value of 1 if the font height in pixels is less than 6.
- K - fDialogBox (1 bit):** A bit that specifies whether the font is used in the context of a dialog box. The value of this field MUST be equal to 0.
- unused1 (5 bits):** MUST be zero, and MUST be ignored.
- boldness (2 bytes):** An unsigned integer that specifies the font weight. The value of this field MUST be equal to the value of the **bls** field of the associated Font record.
- subscript (2 bytes):** An unsigned integer that specifies whether superscript, subscript, or normal script is used. The value of this field MUST be equal to the value of the **sss** field of the associated Font record.
- bUnderline (1 byte):** An unsigned integer that specifies the underline style. The value of this field MUST be equal to the value of the **uls** field of the associated Font record.
- bFamily (1 byte):** An unsigned integer that specifies the **font family** of this font. The value of this field MUST be equal to the value of the **bFamily** field of the associated Font record.
- bCharSet (1 byte):** An unsigned integer that specifies the **character set**. The value of this field MUST be equal to the value of the **bCharSet** field of the associated Font record.
- unused2 (1 byte):** MUST be zero, and MUST be ignored.
- rgbFontColor (4 bytes):** A [LongRGB](#) that specifies the font color. The value of this field MUST be equal to the value of the **icv** field of the associated Font record.
- dwDrawingMode (4 bytes):** An unsigned integer that specifies the display mode of the background of the text. The value of this field MUST be equal to 0x0000010D when the **wBkgMode** field of the associated Text record is equal to 0x0001; otherwise, it MUST be equal to 0x0000020D.
- bRotation (1 byte):** An unsigned integer that specifies the text rotation. The value of this field MUST be equal to the value of the **trot** field of the associated Text record.
- dwHAlignment (4 bytes):** An unsigned integer that specifies the horizontal alignment of the text. The value of this field MUST equal to the value of the **at** field of the associated Text record.
- dwVAlignment (4 bytes):** An unsigned integer that specifies the vertical alignment of the text. The value of this field MUST be equal to the value of the **vat** field of the associated Text record.

bReadingOrder (1 byte): An unsigned integer that specifies the reading order of the text. The value of this field MUST be equal to the value of the **iReadingOrder** field of the associated Text record.

2.5.269 Top10FT

The **Top10FT** enumeration specifies the **top N filter** type.

Name	Value	Meaning
TOP10FTUNKNOWN	0x00000000	None
TOP10FTCOUNT	0x00000001	Count
TOP10FTPERCENT	0x00000002	Percent
TOP10FTSUM	0x00000003	Sum

2.5.270 Ts

The **Ts** structure specifies the italic and **strikethrough formatting** of a **font**.

0	1	2	3	4	5	6	7	8	9	10	11	12	13	14	15	16	17	18	19	20	21	22	23	24	25	26	27	28	29	30	31
A	B	unused2					C	unused3																							

A - unused1 (1 bit): Undefined and MUST be ignored.

B - ftsItalic (1 bit): A bit that specifies whether the text **style** is italic.

unused2 (5 bits): Undefined and MUST be ignored.

C - ftsStrikeout (1 bit): A bit that specifies whether the font has strikethrough formatting applied.

unused3 (24 bits): Undefined and MUST be ignored.

2.5.271 TxOLastRun

The **TxOLastRun** structure marks the end of the **formatting run** information in the [TxORuns](#) structure.

0	1	2	3	4	5	6	7	8	9	10	11	12	13	14	15	16	17	18	19	20	21	22	23	24	25	26	27	28	29	30	31
cchText																unused1															
unused2																															

cchText (2 bytes): An unsigned integer that specifies the number of characters in the preceding [TxO](#) record. The value MUST be the count of characters specified in the **cchText** field of the preceding TxO record.

unused1 (2 bytes): Undefined and MUST be ignored.

unused2 (4 bytes): Undefined and MUST be ignored.

2.5.272 TxORuns

The **TxORuns** structure specifies the **formatting run** information for the **TxO** record and zero or more **Continue** records immediately following.

0	1	2	3	4	5	6	7	8	9	10	11	12	13	14	15	16	17	18	19	20	21	22	23	24	25	26	27	28	29	30	31
rgTxoRuns (variable)																															
...																															
lastRun																															
...																															

rgTxoRuns (variable): An array of **Run**. Each Run specifies the formatting information for a **text run**. **formatRun.ich** MUST be less than or equal to **cchText** of the preceding TxO record. The number of elements in this array is as follows:

(**cbRuns** of the preceding TxO record / 8 - 1).

lastRun (8 bytes): A **TxOLastRun** that marks the end of the text run. This field is only present in the last Continue record following the TxO record. [<188>](#)

2.5.273 TxtWf

The **TxtWf** structure specifies a field in text to column.

0	1	2	3	4	5	6	7	8	9	10	11	12	13	14	15	16	17	18	19	20	21	22	23	24	25	26	27	28	29	30	31
fieldType																															
fieldStart																															

fieldType (4 bytes): An unsigned integer that specifies the format of the field. MUST be a value from the following table:

Value	Meaning
0x00000000	General
0x00000001	Text
0x00000002	Date in the order month, day, year
0x00000003	Date in the order day, month, year
0x00000004	Date in the order year, month, day
0x00000005	Date in the order month, year, day
0x00000006	Date in the order day, year, month
0x00000007	Date in the order year, day, month
0x00000008	Skip importing field
0x00000009	Taiwan era dates.

fieldStart (4 bytes): An unsigned integer that specifies the character position of the field. The offset is zero-based and MUST be greater than or equal to 0.

2.5.274 Underline

The **Underline** enumeration specifies the underline style.

Name	Value	Meaning
ULSNONE	0x0000	No underline
ULSSINGLE	0x0001	Single
ULSDOUBLE	0x0002	Double
ULSSINGLEACCOUNTANT	0x0021	Single accounting
ULSDOUBLEACCOUNTANT	0x0022	Double accounting

2.5.275 VertAlign

The **VertAlign** enumeration specifies the vertical alignment.

Name	Value	Meaning
ALCVTOP	0x00	Top alignment
ALCVCTR	0x01	Center alignment
ALCVBOT	0x02	Bottom alignment
ALCVJUST	0x03	Justify alignment
ALCVDIST	0x04	Distributed alignment

2.5.276 VertBrk

The **VertBrk** structure specifies one column **page break**.

0	1	2	3	4	5	6	7	8	9	10	11	12	13	14	15	16	17	18	19	20	21	22	23	24	25	26	27	28	29	30	31
col																rowStart															
rowEnd																															

col (2 bytes): A [ColU](#) that specifies the zero-based index of the first column to the right of the page break.

rowStart (2 bytes): A [RwU](#) that specifies the zero-based index of the first row on the page.

rowEnd (2 bytes): A [RwU](#) that specifies the zero-based index of the last row on the page. The value MUST be greater than **rowStart**.

2.5.277 VirtualPath

VirtualPath is a [XLUnicodeString](#) that specifies a path, a workbook, and optionally a **sheet**.

MUST be a string in the following grammar:

```
virt-path = volume / unc-volume / rel-volume / transfer-protocol / startup / alt-startup /
library / simple-file-path / ole-link
ole-link = path-string %x0003 path-string
simple-file-path = [%x0001] file-path
startup = %x0001 %x0006 file-path
```

This code specifies that the relative-path is relative to the **startup directory**.

```
alt-startup = %x0001 %x0007 file-path
```

This code specifies that the relative-path is relative to the **alternate startup directory**.

```
library = %x0001 %x0008 file-path
```

This code specifies that the relative-path is relative to the **library directory**.

```
transfer-protocol = %x0001 %x0005 count transfer-path
```

This code specifies that the path is a **transfer protocol** path. The value of count MUST be equal to the number of characters following count in transfer-path.

```
transfer-path = transfer-base-path / "[" transfer-base-path "]" sheet-name
transfer-base-path = transfer-type "://" file-path
transfer-type = "ftp" / "http" / "https"
rel-volume = %x0001 %x0002 file-path
```

This code specifies that the path is relative to the drive volume of the workbook that contains the path.

```
volume = %x0001 %x0001 volume-character file-path
```

This code specifies that the path is relative to a specific drive volume. The drive volume is specified in volume-character.

```
unc-volume = %x0001 %x0001 %x0040 unc-path
```

This code specifies that the path is relative to a **UNC volume**. The computer name is specified in computer-name and the shared folder is specified in shared-folder.

```
unc-path = unc-base-path / "[" unc-base-path "]" sheet-name
unc-base-path = computer-name %x0003 shared-folder %x0003 relative-path
volume-character = %x0041-%x005A / %x0061-%x007A
```

This code specifies a drive volume.

```
file-path = relative-path / "[" relative-path "]" sheet-name
sheet-name = sheet-start-end-character *sheet-character sheet-start-end-character / sheet-
start-end-character
```

This code specifies the name of the sheet within the workbook.

```
sheet-start-end-character = %x0001-%xFFFF
```

This code specifies a character which is a first or last character of sheet name. Such character MUST NOT include any character that matches invalid-sheet-start-end-character.

```
invalid-sheet-start-end-character = %x0003 / "*" / "?" / "'" / "[" / "]" / "\" / ":"  
/ "/"  
sheet-character = %x0001-%xFFFF
```

This code specifies a sheet character. A sheet character MUST NOT include any character that matches invalid-sheet-character.

```
invalid-sheet-character = %x0003 / "*" / "?" / / "[" / "]" / "\" / ":" / "/"  
relative-path = directory *(%x0003 directory)
```

This code specifies a sequence of subdirectories that comprise the path from the volume or directory.

```
directory = path-string
```

This code specifies a directory.

```
computer-name = path-string
```

This code specifies a computer name.

```
shared-folder = path-string
```

This code specifies a shared folder.

```
path-string = 1*path-character  
path-character = %x0020-%x0021 / %x0023-%x0029 / %x002B-%x002E / %x0030-%x0039 / %x003B /  
%x003D / %x0040-%x005B / %x005D-%x007B / %x007D-%xFFFF
```

This code specifies a path character.

```
count = %x00-%xFF
```

2.5.278 WebPubString

The **WebPubString** structure specifies a string for Web publishing.

0	1	2	3	4	5	6	7	8	9	10	11	12	13	14	15	16	17	18	19	20	21	22	23	24	25	26	27	28	29	30	31
cch																str (variable)															

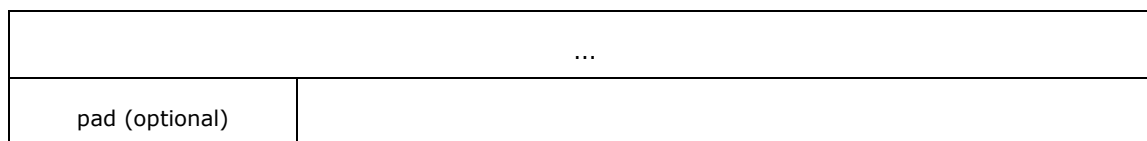

cch (2 bytes): An unsigned integer that specifies the character count in the **str** field. MUST be greater than or equal to zero and less than or equal to 255.

str (variable): An [XLUnicodeStringNoCch](#). The character count in the string MUST be equal to the value of the **cch** field.

pad (1 byte): Unused and MUST be ignored. This field exists if and only if the total number of bytes in the **str** field is an odd number.

2.5.279 XColorType

The **XColorType** enumeration specifies the color reference types. It MUST be one of the following values:

Name	Value	Meaning
XCLRAUTO	0x00000000	Automatic color
XCLRINDEXED	0x00000001	Indexed color
XCLRRGB	0x00000002	RGB color
XCLRTHEMED	0x00000003	Theme color
XCLRINCHED	0x00000004	Color not set

2.5.280 XExtGradient

The **XExtGradient** structure specifies a gradient fill for a **cell** interior.

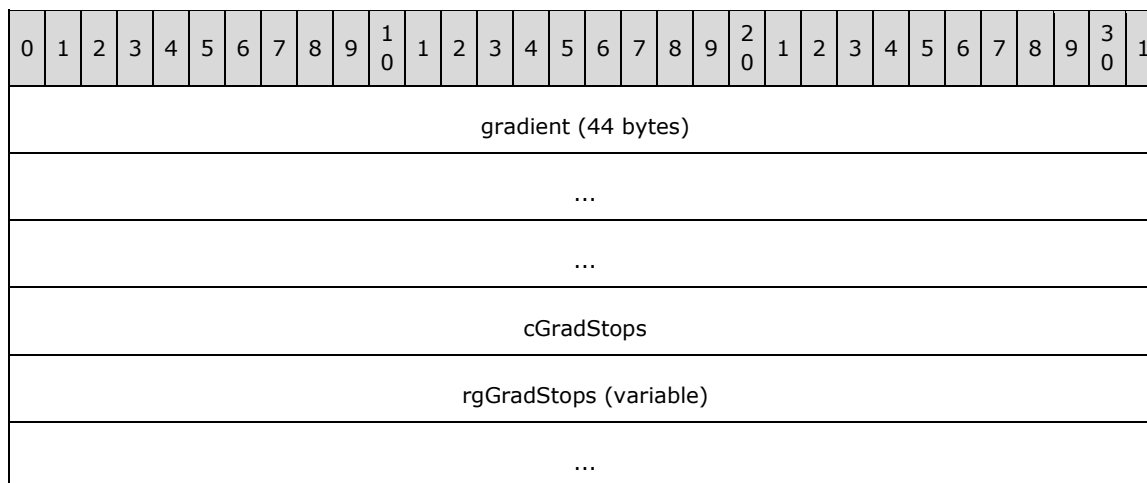

gradient (44 bytes): An [XFPropGradient](#) that specifies the gradient fill.

cGradStops (4 bytes): An unsigned integer that specifies the number of items in **rgGradStops**. MUST be greater than or equal to 0 and less than or equal to 256.

rgGradStops (variable): An array of [GradStop](#). Each array element specifies a gradient stop for this gradient fill.

2.5.281 XFExtNoFRT

The **XFExtNoFRT** structure specifies a set of extensions to formatting properties.

0	1	2	3	4	5	6	7	8	9	10	11	12	13	14	15	16	17	18	19	20	21	22	23	24	25	26	27	28	29	30	31
reserved1																reserved2															
reserved3																cexts															
rgExt (variable)																															
...																															

reserved1 (2 bytes): MUST be zero and MUST be ignored.

reserved2 (2 bytes): MUST be equal to 0xFFFF and MUST be ignored.

reserved3 (2 bytes): MUST be zero and MUST be ignored.

cexts (2 bytes): An unsigned integer that specifies the number of elements in **rgExt**.

rgExt (variable): An array of [ExtProp](#). Each array element specifies an extension to a formatting property. The element count of this field MUST be equal to **cexts**.

2.5.282 XFIndex

The **XFIndex** structure specifies the index of a [XF](#) record.

0	1	2	3	4	5	6	7	8	9	10	11	12	13	14	15	16	17	18	19	20	21	22	23	24	25	26	27	28	29	30	31
ixfe																															

ixfe (2 bytes): An unsigned integer that specifies a zero-based index of a XF record in the collection of XF records in the [Globals Substream](#).

The XF records in the file refer to both and [Cell Style XFs](#) and [Cell XFs](#). For more information, see [Styles](#).

The XF records in the file can be divided into three sections. The first section contains the 16 built-in XF records that MUST exist and MUST be ordered as follows:

Index	XF specifies	fStyle value
0	Normal style	1
1	Row outline level 1	1
2	Row outline level 2	1
3	Row outline level 3	1
4	Row outline level 4	1
5	Row outline level 5	1
6	Row outline level 6	1

Index	XF specifies	fStyle value
7	Row outline level 7	1
8	Column outline level 1	1
9	Column outline level 2	1
10	Column outline level 3	1
11	Column outline level 4	1
12	Column outline level 5	1
13	Column outline level 6	1
14	Column outline level 7	1
15	Default cell format	0

The second section contains XF records for both built-in and user-defined Cell Style XFs. These Cell Style XFs MUST be ordered alphabetically in the file based on their name. The name of the Cell Style XF is specified by the **user** field of the corresponding [Style](#) record. The corresponding Style record is the one with an **ixfe** field that specifies the XF record of the Cell Style XF. Note that the ordering depends on the localized name of the style and the language of the application that last saved the file.

For example, in a workbook created by a specific version of the application [<189>](#) with no user-defined [cell styles](#) the remainder of the table is:

Index	Name of Style	fStyle value
16	20% - Accent1	1
17	20% - Accent2	1
18	20% - Accent3	1
19	20% - Accent4	1
20	20% - Accent5	1
21	20% - Accent6	1
22	40% - Accent1	1
23	40% - Accent2	1
24	40% - Accent3	1
25	40% - Accent4	1
26	40% - Accent5	1
27	40% - Accent6	1
28	60% - Accent1	1
29	60% - Accent2	1
30	60% - Accent3	1
31	60% - Accent4	1
32	60% - Accent5	1
33	60% - Accent6	1
34	Accent1	1
35	Accent2	1
36	Accent3	1
37	Accent4	1
38	Accent5	1
39	Accent6	1
40	Bad	1
41	Calculation	1
42	Check Cell	1
43	Comma	1

Index	Name of Style	fStyle value
44	Comma[0]	1
45	Currency	1
46	Currency[0]	1
47	Explanatory Text	1
48	Good	1
49	Heading 1	1
50	Heading 2	1
51	Heading 3	1
52	Heading 4	1
53	Input	1
54	Linked Cell	1
55	Neutral	1
56	Note	1
57	Output	1
58	Percent	1
59	Title	1
60	Total	1
61	Warning Text	1

The last section contains unordered XFs for any Cell XFs in the file.

2.5.283 XFProp

The **XFProp** structure specifies a formatting property. Instances of this structure appear as elements in the **xfPropArray** field of an **XFProps** structure.

0	1	2	3	4	5	6	7	8	9	10	11	12	13	14	15	16	17	18	19	20	21	22	23	24	25	26	27	28	29	30	31
xfPropType																cb															
xfPropDataBlob (variable)																															
...																															

xfPropType (2 bytes): An unsigned integer that specifies the type of the formatting property. MUST be greater than or equal to 0x0000 and less than or equal to 0x002C, and MUST NOT equal 0x0027 or 0x0028. See the table in **xfPropDataBlob** for more information about the meaning of this field.

cb (2 bytes): An unsigned integer that specifies the size of this XFProp structure.

xfPropDataBlob (variable): A field that specifies the formatting property data. The size and data type of this field varies based on the property type as specified in **xfPropType** as follows:

xfPropType value	xfPropDataBlob field Data and Meaning
0x0000	A FillPattern that specifies the fill pattern .
0x0001	An XFPropColor that specifies the foreground color.
0x0002	An XFPropColor that specifies the background color.
0x0003	An XFPropGradient that specifies the gradient fill . This is often followed in the same

xfPropType value	xfPropDataBlob field Data and Meaning
	xfPropArray field of the XFProps structure by one or more XFProp structures with xfPropType equal to 0x0004, which provides additional specifications for the gradient fill.
0x0004	An XFPropGradientStop that specifies a gradient stop for a preceding XFProp with xfPropType equal to 0x0003 in the same xfPropArray field in the XFProps structure.
0x0005	An XFPropColor that specifies the text color.
0x0006	An XFPropBorder that specifies the top border formatting.
0x0007	An XFPropBorder that specifies the bottom border formatting.
0x0008	An XFPropBorder that specifies the left border formatting.
0x0009	An XFPropBorder that specifies the right border formatting.
0x000A	An XFPropBorder that specifies the diagonal border formatting.
0x000B	An XFPropBorder that specifies the vertical border formatting.
0x000C	An XFPropBorder that specifies the horizontal border formatting.
0x000D	A 1-byte unsigned integer that specifies whether a diagonal-up border is used. MUST be 0 or 1. The value of 1 means that a diagonal-up border is used.
0x000E	A 1-byte unsigned integer that specifies whether a diagonal-down border is used. MUST be 0 or 1. The value of 1 means that a diagonal-down border is used.
0x000F	A HorizAlign that specifies the horizontal alignment .
0x0010	A VertAlign that specifies the vertical alignment .
0x0011	An XFPropTextRotation that specifies the text rotation.
0x0012	A 2-byte unsigned integer that specifies the absolute text indentation level . MUST be less than or equal to 15. The absolute indentation level replaces any previous indentation.
0x0013	A ReadingOrder that specifies the reading order .
0x0014	A 1-byte unsigned integer that specifies whether cell text is wrapped. MUST be 0 or 1. The value of 1 means that the text is wrapped.
0x0015	A 1-byte unsigned integer that specifies whether cell text is justify distributed . MUST be 0 or 1. The value of 1 means that the text is justify distributed. If this value is 1 then an XFProp with xfPropType equal to 0x000F MUST exist in this xfPropArray field of the XFProps structure and MUST equal 0x07.
0x0016	A 1-byte unsigned integer that specifies whether a cell is shrink to fit . MUST be 0 or 1. The value of 1 means that the cell is shrink to fit.
0x0017	A 1-byte unsigned integer that specifies whether a cell is merged. MUST be 0 or 1. The value of 1 means that the cell is merged.
0x0018	An LPWideString that specifies the font name used by the cell data. MUST be less than or equal to 32 characters in length.
0x0019	A Bold that specifies the font face weight .
0x001A	An Underline that specifies the underline style.
0x001B	A Script that specifies the superscript or subscript style.
0x001C	A 1-byte unsigned integer that specifies whether text is italicized. MUST be 0 or 1. The value of 1 means that the text is italic.
0x001D	A 1-byte unsigned integer that specifies whether text has strikethrough formatting applied. MUST be 0 or 1. The value of 1 means that the text has strikethrough formatting applied.
0x001E	A 1-byte unsigned integer that specifies whether text has an outline style. MUST be 0 or 1. The value of 1 means that the text is outline style.
0x001F	A 1-byte unsigned integer that specifies whether text has a shadow style. MUST be 0 or 1. The value of 1 means that the text is shadow style.
0x0020	A 1-byte unsigned integer that specifies whether text is condensed. MUST be 0 or 1. The value of 1 means that the text is condensed.
0x0021	A 1-byte unsigned integer that specifies whether text is extended. MUST be 0 or 1. The value of 1 means that the text is extended.
0x0022	A 1-byte unsigned integer that specifies a character set . For more information about

xfPropType value	xfPropDataBlob field Data and Meaning
	character sets, see the Windows API LOGFONT structure in [MSDN-FONTS] .
0x0023	A 1-byte unsigned integer that specifies a font family . For more information about font families, see the Windows API LOGFONT structure in [MSDN-FONTS] . MUST be greater than or equal to 0 and less than or equal to 5.
0x0024	A 4-byte unsigned integer that specifies text size in twips . MUST be greater than or equal to 20 and less than or equal to 8191.
0x0025	A FontScheme that specifies the font scheme of a theme font .
0x0026	A number format as specified by the stFormat field of Format that specifies the number format string .
0x0029	An IFmt that specifies a number format identifier.
0x002A	A 2-byte signed integer that specifies the relative text indentation level. The relative indentation level is added to any previous indentation. The value MUST either be greater than or equal to -15 and less than or equal to 15, or it MUST be 255. Values -15 through 15 specify a relative indentation level, and the value 255 specifies the absence of a relative indentation level.
0x002B	A 1-byte unsigned integer that specifies whether the locked protection property is set to true. MUST be 0 or 1. The value of 1 means that the property is set to true.
0x002C	A 1-byte unsigned integer that specifies whether the hidden protection property is set to true. MUST be 0 or 1. The value of 1 means that the property is set to true.

2.5.284 XFPropBorder

The **XFPropBorder** structure specifies **border formatting**.

0	1	2	3	4	5	6	7	8	9	10	1	2	3	4	5	6	7	8	9	20	1	2	3	4	5	6	7	8	9	30	1
color																															
...																															
dgBorder																															

color (8 bytes): An [XFPropColor](#) that specifies the border color.

dgBorder (2 bytes): A [BorderStyle](#) that specifies the border **line style**.

2.5.285 XFPropColor

The **XFPropColor** structure specifies a color.

0	1	2	3	4	5	6	7	8	9	10	1	2	3	4	5	6	7	8	9	20	1	2	3	4	5	6	7	8	9	30	1
A	xclrType					icv					nTintShade																				
dwRgba																															

A - fValidRGBA (1 bit): A bit that specifies whether the **xclrType**, **icv** and **nTintShade** fields were used to set the **dwRgba** field. MUST equal 1.

xclrType (7 bits): An [XColorType](#) that specifies how the color information is stored.

icv (1 byte): An unsigned integer that specifies color information. If **xclrType** equals 0x01, this field MUST be one of the values specified in [IcvXF](#), or equal 0. If **xclrType** equals 0x03, this field MUST be one of the values specified in [ColorTheme](#). Otherwise this field is undefined and MUST be ignored.

nTintShade (2 bytes): A signed integer that specifies the tint of the color. This value is mapped to the range -1.0 to 1.0. Positive values lighten the color, and negative values darken the color. MUST NOT equal -32768.

dwRgba (4 bytes): A [LongRGBA](#) that specifies the color.

2.5.286 XFPPropGradient

The **XFPPropGradient** structure specifies a **gradient fill**.

0	1	2	3	4	5	6	7	8	9	10	11	12	13	14	15	16	17	18	19	20	21	22	23	24	25	26	27	28	29	30	31
type																															
numDegree																															
...																															
numFillToLeft																															
...																															
numFillToRight																															
...																															
numFillToTop																															
...																															
numFillToBottom																															
...																															

type (4 bytes): A Boolean (section [2.5.14](#)) that specifies the gradient type. MUST be a value from the following table:

Value	Meaning
0x00000000	Linear gradient
0x00000001	Rectangular gradient

numDegree (8 bytes): An Xnum (section [2.5.342](#)) that specifies the gradient angle in degrees for a linear gradient. The gradient angle specifies the angle at which gradient strokes are drawn.

numFillToLeft (8 bytes): An Xnum that specifies the left coordinate of the **inner rectangle** for a rectangular gradient, where (0.0,0.0) is the upper-left hand corner of the inner rectangle. MUST be greater than or equal to 0.0 and less than or equal to 1.0.

numFillToRight (8 bytes): An Xnum that specifies the right coordinate of the inner rectangle for a rectangular gradient, where (0.0,0.0) is the upper-left hand corner of the inner rectangle. MUST be greater than or equal to 0.0 and less than or equal to 1.0.

numFillToTop (8 bytes): An Xnum that specifies the top coordinate of the inner rectangle for a rectangular gradient, where (0.0,0.0) is the upper-left hand corner of the inner rectangle. MUST be greater than or equal to 0.0 and less than or equal to 1.0.

numFillToBottom (8 bytes): An Xnum that specifies the bottom coordinate of the inner rectangle for a rectangular gradient, where (0.0,0.0) is the upper-left hand corner of the inner rectangle. MUST be greater than or equal to 0.0 and less than or equal to 1.0.

2.5.287 XFPropGradientStop

The **XFPropGradientStop** structure specifies a **gradient stop** for a **gradient fill**.

0	1	2	3	4	5	6	7	8	9	10	11	12	13	14	15	16	17	18	19	20	21	22	23	24	25	26	27	28	29	30	31
unused											numPosition																				
...																															
...																color															
...																															
...																															

unused (2 bytes): Undefined and MUST be ignored.

numPosition (8 bytes): An Xnum (section [2.5.342](#)) that specifies the gradient stop position. The gradient stop position is the position within the gradient range where this gradient stop's color begins. MUST be greater than or equal to 0.0 and less than or equal to 1.0.

color (8 bytes): An [XFPropColor](#) that specifies the gradient stop color.

2.5.288 XFProps

This structure specifies an array of formatting properties.

0	1	2	3	4	5	6	7	8	9	10	11	12	13	14	15	16	17	18	19	20	21	22	23	24	25	26	27	28	29	30	31
reserved											cprops																				
xfPropArray (variable)																															
...																															

reserved (2 bytes): MUST be zero and MUST be ignored.

cprops (2 bytes): An unsigned integer that specifies the number of [XFProp](#) structures in **xfPropArray**.

xfPropArray (variable): An array of XFProp. Each array element specifies a formatting property. The array of properties specifies the full set of formatting properties. If the array contains an XFProp with an **xfPropType** field equaling 0, the array MUST NOT contain any XFProp elements with **xfPropType** fields equaling 3 or 4. If the array contains an XFProp with an **xfPropType** field equaling 3 or 4, the array MUST NOT contain any XFProp elements with an **xfPropType** field equaling 0.

2.5.289 XFPropTextRotation

The **XFPropTextRotation** structure specifies the text rotation.

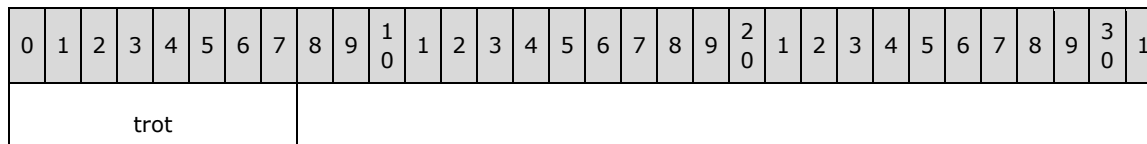

trot (1 byte): An unsigned integer that specifies the text rotation. MUST be a value from the following table:

Value	Meaning
0x00 to 0x5A (0 to 90)	Text rotated counterclockwise 0 to 90 degrees
0x5B to 0xB4 (91 to 180)	Text rotated clockwise 1 to 90 degrees
0xFF (255)	Vertical text

2.5.290 XLNameUnicodeString

The **XLNameUnicodeString** structure specifies a **defined name**.

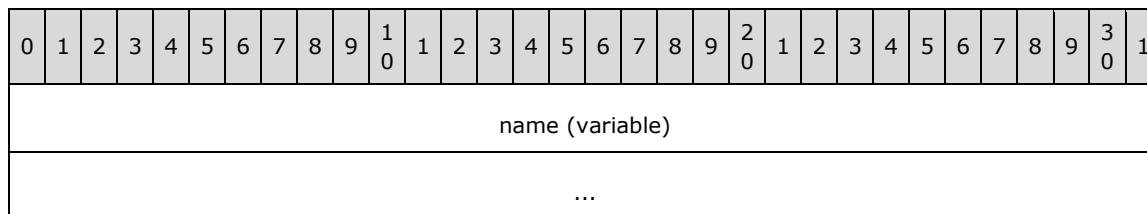

name (variable): An [XLUnicodeString](#) that specifies the name. The number of characters in the string, **name.cch**, MUST be greater than or equal to 1 and less than or equal to 255.

This field MUST adhere to the following grammar:

```
name = name-start-character, *name-characters
name-start-character = "_" / "\" / Unicode-character
name-character = name-start-character / "." / "?" / 0x061F / Unicode-digit
```

where:

Unicode-character is any code point which is a character as defined by the Unicode character properties in chapter four of the [\[RFC2781\]](#)

Unicode-digit is any code point which is a digit as defined by the Unicode character properties in chapter four of the [RFC2781].

This field MUST NOT be equal to "TRUE" or "FALSE" using case-insensitive string comparison. This field MUST NOT be an **R1C1** or **A1 cell reference**.

An R1C1 **cell** reference is defined to be:

```
R1C1-cell-reference= R1C1-row R1C1-column / R1C1-column R1C1-row
R1C1-row = letter-r row-number
letter-r = "R" / "r"
R1C1-column = letter-c column-number
letter-c = "C" / "c"
column-number = 1-256
row-number = 1-65536
```

An A1 cell reference is defined as follows:

```
A1-reference = A1-column A1-Row
A1-row = row-number
; See definition of row-number in R1C1 cell reference grammar specified previously.
A1-column = letter / letter-limited-one letter / letter-i letter-limited-two
letter-limited-one = "A" / "B" / "C" / "D" / "E" / "F" / "G" / "H" / "a" / "b" / "c" / "d" /
"e" / "f" / "g" / "h"
letter-limited-two = letter-limited-one / "I" / "J" / "K" / "L" / "M" / "N" / "O" / "P" / "Q" /
"R" / "S" / "T" / "U" / "V" / "i" / "j" / "k" / "l" / "m" / "n" / "o" / "p" / "q" / "r" /
"s" / "t" / "u" / "v"
letter-i = "I" / "i"
letter = letter-limited-two / "W" / "X" / "Y" / "Z" / "w" / "x" / "y" / "z"
```

2.5.291 XlsFilter_Criteria

The **XlsFilter_Criteria** structure specifies **filter** criteria.

0	1	2	3	4	5	6	7	8	9	10	11	12	13	14	15	16	17	18	19	20	21	22	23	24	25	26	27	28	29	30	31
ezdoper1																															
...																															
...																ezdoper2															
...																															
...																															

djoin1
reserved

ezdoper1 (10 bytes): An [SXEZDoper](#) structure that specifies the first filter operation. If the **ccriteria** field of the [SXAddl_SXCSXFilter12_SDXIsFilter](#) that contains this structure is zero, then **ezdoper1.vts** MUST be zero and **ezdoper1** MUST be ignored. If **ezdoper1.vts** equals 0x6, the following record MUST be [SXAddl_SXCSXFilter12_SDXIsFilterValue1](#).

ezdoper2 (10 bytes): An [SXEZDoper](#) structure that specifies the second filter operation. If the **ccriteria** field of the [SXAddl_SXCSXFilter12_SDXIsFilter](#) that contains this structure is not equal to 2, then **ezdoper2.vts** MUST be zero and **ezdoper2** MUST be ignored. If **ezdoper1.vts** is not 0x6 and **ezdoper2.vts** is 0x6, then the following record is [SXAddl_SXCSXFilter12_SDXIsFilterValue2](#). If both **ezdoper1.vts** and **ezdoper2.vts** are 0x6, then the following record is [SXAddl_SXCSXFilter12_SDXIsFilterValue1](#), and the next non-[Continue_SxaddlSxString](#) record after that is [SXAddl_SXCSXFilter12_SDXIsFilterValue2](#).

djoin1 (4 bytes): A [DJoin](#) that specifies the join operation between **ezdoper1** and **ezdoper2**.

MUST be [DJOINNULL](#) if the **ccriteria** field of the [SXAddl_SXCSXFilter12_SDXIsFilter](#) record is less than 2.

reserved (4 bytes): MUST be zero, and MUST be ignored.

2.5.292 XIsFilter_Top10

The **XIsFilter_Top10** structure specifies filter information for a **top N filter**.

0	1	2	3	4	5	6	7	8	9	10	11	12	13	14	15	16	17	18	19	20	21	22	23	24	25	26	27	28	29	30	31
top10ft																															
A	reserved1															numTopN															
...																															
...																reserved2 (14 bytes)															
...																															
...																															
...																															

top10ft (4 bytes): A [Top10FT](#) that specifies the top N filter type.

A - fTop (1 bit): A bit that specifies whether the filter displays the top or bottom records.

Value	Meaning
0	Display the bottom records.
1	Display the top records.

reserved1 (15 bits): MUST be zero, and MUST be ignored.

numTopN (8 bytes): An Xnum (section [2.5.342](#)) that specifies the number or percentage of records to include.

If **top10ft** is TOP10FTPERCENT, **numTopN** specifies the percentage of records to include; otherwise **numTopN** specifies the number of records to include.

If **top10ft** is TOP10FTPERCENT, **numTopN** MUST be greater than or equal to 0 and less than or equal to 100.

If **top10ft** is TOP10FTSUM, **numTopN** MUST be greater than or equal to 0 and less than or equal to 2147483647.

If **top10ft** is TOP10FTCOUNT, **numTopN** MUST be an integer greater than or equal to 0 and less than or equal to 2147483647.

reserved2 (14 bytes): MUST be zero, and MUST be ignored.

2.5.293 XLUnicodeRichExtendedString

The **XLUnicodeRichExtendedString** structure specifies a Unicode string, which can contain formatting information and **phonetic string** data.

This structure's non-variable fields MUST be specified in the same record.

This structure's variable fields can be extended with [Continue](#) records. A value from the table for **fHighByte** MUST be specified in the first byte of the **continue** field of the Continue record followed by the remaining portions of this structure's variable fields.

0	1	2	3	4	5	6	7	8	9	10	11	12	13	14	15	16	17	18	19	20	21	22	23	24	25	26	27	28	29	30	31				
cch																A	B	C	D	reserved2				cRun (optional)											
...										cbExtRst (optional)																									
...										rgb (variable)																									
...																																			
rgRun (variable, optional)																																			
...																																			
ExtRst (variable, optional)																																			
...																																			

cch (2 bytes): An unsigned integer that specifies the count of characters in the string.

A - fHighByte (1 bit): A bit that specifies whether the characters in **rgb** are double-byte characters. MUST be a value from the following table:

Value	Meaning
0x0	All the characters in the string have a high byte of 0x00 and only the low bytes are in rgb .
0x1	All the characters in the string are saved as double-byte characters in rgb .

B - reserved1 (1 bit): MUST be zero, and MUST be ignored.

C - fExtSt (1 bit): A bit that specifies whether the string contains phonetic string data.

D - fRichSt (1 bit): A bit that specifies whether the string is a rich string and the string has at least two character formats applied.

reserved2 (4 bits): MUST be zero, and MUST be ignored.

cRun (2 bytes): An optional unsigned integer that specifies the number of elements in **rgRun**. MUST exist if and only if **fRichSt** is 0x1.

cbExtRst (4 bytes): An optional signed integer that specifies the byte count of **ExtRst**. MUST exist if and only if **fExtSt** is 0x1. MUST be zero or greater.

rgb (variable): An array of bytes that specifies the characters in the string. If **fHighByte** is 0x0, the size of the array is **cch**. If **fHighByte** is 0x1, the size of the array is **cch*2**. If **fHighByte** is 0x1 and **rgb** is extended with a Continue record the break MUST occur at the double-byte character boundary.

rgRun (variable): An optional array of [FormatRun](#) structures that specifies the formatting for each **text run**. The number of elements in the array is **cRun**. MUST exist if and only if **fRichSt** is 0x1.

ExtRst (variable): An optional [ExtRst](#) that specifies the phonetic string data. The size of this field is **cbExtRst**. MUST exist if and only if **fExtSt** is 0x1.

2.5.294 XLUnicodeString

The **XLUnicodeString** structure specifies a **Unicode** string.

0	1	2	3	4	5	6	7	8	9	0	1	2	3	4	5	6	7	8	9	0	1	2	3	4	5	6	7	8	9	0	1		
cch																A	reserved						rgb (variable)										
...																																	

cch (2 bytes): An unsigned integer that specifies the count of characters in the string.

A - fHighByte (1 bit): A bit that specifies whether the characters in **rgb** are double-byte characters. MUST be a value from the following table:

Value	Meaning
0x0	All the characters in the string have a high byte of 0x00 and only the low bytes are in rgb .
0x1	All the characters in the string are saved as double-byte characters in rgb .

reserved (7 bits): MUST be zero, and MUST be ignored.

rgb (variable): An array of bytes that specifies the characters. If **fHighByte** is 0x0, the size of the array MUST be equal to **cch**. If **fHighByte** is 0x1, the size of the array MUST be equal to **cch*2**.

2.5.295 XLUnicodeStringMin2

The **XLUnicodeStringMin2** structure specifies a **Unicode** string.

0	1	2	3	4	5	6	7	8	9	10	11	12	13	14	15	16	17	18	19	20	21	22	23	24	25	26	27	28	29	30	31
cch																st (variable)															
...																															

cch (2 bytes): An unsigned integer that specifies the count of characters in the string. MUST be equal to the number of characters in **st**.

st (variable): An optional [XLUnicodeStringNoCch](#) that specifies the string. MUST exist if and only if **cch** is greater than zero.

2.5.296 XLUnicodeStringNoCch

The **XLUnicodeStringNoCch** structure specifies a Unicode string. When an **XLUnicodeStringNoCch** is used, the count of characters in the string MUST be specified in the structure that uses the **XLUnicodeStringNoCch**.

0	1	2	3	4	5	6	7	8	9	10	11	12	13	14	15	16	17	18	19	20	21	22	23	24	25	26	27	28	29	30	31
A	reserved							rgb (variable)																							
...																															

A - fHighByte (1 bit): A bit that specifies whether the characters in **rgb** are double-byte characters. MUST be a value from the following table:

Value	Meaning
0x0	All the characters in the string have a high byte of 0x00 and only the low bytes are in rgb .
0x1	All the characters in the string are saved as double-byte characters in rgb .

reserved (7 bits): MUST be zero, and MUST be ignored.

rgb (variable): An array of bytes that specifies the characters. If **fHighByte** is 0x0, the size of the array MUST be equal to the count of characters in the string. If **fHighByte** is 0x1, the size of the array MUST be equal to 2 times the count of characters in the string.

2.5.297 XLUnicodeStringSegmented

The **XLUnicodeStringSegmented** structure specifies a **Unicode** string that is split into multiple string segments. If the count of characters in the string is greater than 512, the string is split into multiple string segments, each of which has a character count of 512 or less.

0	1	2	3	4	5	6	7	8	9	10	11	12	13	14	15	16	17	18	19	20	21	22	23	24	25	26	27	28	29	30	31
cchTotal																															

strings (variable)
...

cchTotal (4 bytes): An unsigned integer that specifies the total count of characters in the string. MUST be less than 2147483644.

strings (variable): An array of [XLUnicodeString](#). Each element specifies a string segment. The **cch** field of each XLUnicodeString element MUST be less than or equal to 512 and greater than 0, and the sum of the **cch** fields of all XLUnicodeString elements MUST be equal to **cchTotal**. MUST exist if and only if **cchTotal** is greater than zero.

2.5.298 XLUnicodeStringSegmentedRTD

The **XLUnicodeStringSegmentedRTD** structure specifies a Unicode string that contains a set of sub-strings.

0	1	2	3	4	5	6	7	8	9	10	11	12	13	14	15	16	17	18	19	20	21	22	23	24	25	26	27	28	29	30	31
cch																															
A	reserved							rgb (variable)																							
...																															

cch (4 bytes): An unsigned integer that specifies the size of **rgb**.

A - fHighByte (1 bit): A bit that specifies whether the characters in **rgb** are double-byte characters. MUST be a value from the following table:

Value	Meaning
0x0	All the characters in the string have a high byte of 0x00 and only the low bytes are in rgb .
0x1	All the characters in the string are saved as double-byte characters in rgb .

reserved (7 bits): MUST be zero, and MUST be ignored.

rgb (variable): An array of bytes that specifies a set of sub-strings. If **fHighByte** is 0x0, the size of the array is **cch**. If **fHighByte** is 0x1, the size of the array is **cch*2**. Each sub-string begins with one or two bytes specifying the count of characters in the sub-string. The count is one byte in length if **fHighByte** is zero and two bytes in length if **fHighByte** is 1. The number of the sub-strings MUST be greater than 2 and less than 40.

2.5.299 XLUnicodeStringSegmentedSXAddI

The **XLUnicodeStringSegmentedSXAddI** structure specifies a Unicode string segment. [SXAddI](#) records use this structure to represent Unicode strings. If the count of characters in the string is greater than 255, the string is split into multiple segments. Each string segment has a character count of 255 or less, and each segment is stored in an SXAddI record.

0	1	2	3	4	5	6	7	8	9	10	11	12	13	14	15	16	17	18	19	20	21	22	23	24	25	26	27	28	29	30	31
cchTotal																															
reserved																strings (variable)															
...																															

cchTotal (4 bytes): An unsigned integer that specifies the total count of characters in the string. If this is the first segment of a string, **cchTotal** MUST be greater than 0. If this is not the first segment of a string, **cchTotal** MUST be zero.

reserved (2 bytes): MUST be zero, and MUST be ignored.

string (variable): An [XLUnicodeString](#) that specifies the string segment. The **cch** field of **string** MUST be less than or equal to 255 and greater than 0.

2.5.300 XmlTkBackWallThicknessFrft

The **XmlTkBackWallThicknessFrft** structure specifies the thickness of the back wall of a [chart](#) as a percentage of the depth of the 3-D **plot area**. The back wall is the **wall** that is parallel to the **category (2) axis**. This structure MUST only be present if the back wall thickness is greater than 0. MUST only be specified if the chart contains a [Chart3d](#) record.

0	1	2	3	4	5	6	7	8	9	10	11	12	13	14	15	16	17	18	19	20	21	22	23	24	25	26	27	28	29	30	31
wallThickness																															
...																															

wallThickness (8 bytes): An [XmlTkDWord](#) that specifies the thickness of the back wall of the chart as a percentage of the depth of the 3-D plot area. The **wallThickness.dValue** MUST be greater than 0, and less than or equal to 100. The **wallThickness.xtHeader.xmlTkTag** field MUST be equal to 0x0035.

2.5.301 XmlTkBaseTimeUnitFrft

The **XmlTkBaseTimeUnitFrft** structure specifies the value of the smallest unit of time used by the date [axis](#). This structure MUST only be present if the **fAutoBase** field of the corresponding [AxcExt](#) record is set to 1 and the **fDateAxis** of the corresponding [AxcExt](#) record is equal to 1.

0	1	2	3	4	5	6	7	8	9	10	11	12	13	14	15	16	17	18	19	20	21	22	23	24	25	26	27	28	29	30	31
baseUnit																															
...																															

baseUnit (6 bytes): An [XmlTkToken](#) that specifies a value that can override the **duBase** field of the corresponding AxcExt record. The **baseUnit.xtHeader.xmlTkTag** field MUST be equal to 0x005F. This field overrides the **duBase** field of the corresponding AxcExt record when the **fAutoBase** field of the AxcExt record is set to 1. The **baseUnit.dValue** MUST be a value from the following table:

Value	Meaning
0x0060	Time value is measured in days.
0x0061	Time value is measured in months.
0x0062	Time value is measured in years.

2.5.302 XmlTkBlob

The **XmlTkBlob** structure specifies an array of bytes for the **xmltkChain** field of the [CrtMIFrt](#) record.

0	1	2	3	4	5	6	7	8	9	10	11	12	13	14	15	16	17	18	19	20	21	22	23	24	25	26	27	28	29	30	31
xtHeader																															
cbBlob																															
rgbBlob (variable)																															
...																															

xtHeader (4 bytes): An [XmlTkHeader](#). The **xtHeader.drType** field MUST be equal to 0x07.

cbBlob (4 bytes): An unsigned integer that specifies the count of bytes of the **rgbBlob** field.

rgbBlob (variable): An array of bytes for the **xmltkChain** field of the [CrtMIFrt](#) record. The size of this field, in bytes, is specified by the **cbBlob** field.

2.5.303 XmlTkBool

The **XmlTkBool** structure specifies a Boolean (section [2.5.14](#)) value for the **xmltkChain** field of the [CrtMIFrt](#) record.

0	1	2	3	4	5	6	7	8	9	10	11	12	13	14	15	16	17	18	19	20	21	22	23	24	25	26	27	28	29	30	31
xtHeader																															
dValue																unused															

xtHeader (4 bytes): An [XmlTkHeader](#). The **xtHeader.drType** field MUST be equal to 0x02.

dValue (1 byte): A Boolean that specifies the value of this structure.

unused (1 byte): Undefined, and MUST be ignored.

2.5.304 XmlTkChain

The **XmlTkChain** structure specifies a chain of structures that specifies a group of additional properties or property overrides for a given [chart](#) element, specified by the **xmltkParent** field. See meanings of the additional properties or property overrides in each token structure.

0	1	2	3	4	5	6	7	8	9	10	11	12	13	14	15	16	17	18	19	20	21	22	23	24	25	26	27	28	29	30	31
recordVersion										unused										xmltkParent											
chainRecords (variable)																															
...																															

recordVersion (1 byte): An unsigned integer that specifies the chain version. MUST be 0.

unused (1 byte): Undefined, and MUST be ignored.

xmltkParent (2 bytes): An unsigned integer that specifies the chart element targeted by the token structures in the chain. MUST be a value from the following table:

Value	Meaning
0x0001	<p>The record that contains this structure MUST be in a sequence of records that conforms to the DVAXIS rule. This sequence of records specifies the chart element targeted by the token structures in this chain.</p> <p>The token structures in the chain specify scaling properties and MUST be one of the following: XmlTkMaxFr, XmlTkMinFr, XmlTkLogBaseFr</p>
0x0002	<p>The record that contains this structure MUST be in a sequence of records that conforms to the CHARTSHEET or CHARTSHEETCONTENT rule. This sequence of records specifies the chart element targeted by the token structures in this chain.</p> <p>The token structures in the chain specify chart space properties and MUST be one of the following: XmlTkStyle, XmlTkThemeOverride, XmlTkColorMappingOverride</p>
0x0004	<p>The record that contains this structure MUST be in a sequence of records that conforms to the IVAXIS rule and SERIESAXIS rule. This sequence of records specifies the chart element targeted by the token structures in this chain.</p> <p>The token structures in the chain specify Axis properties and MUST be one of the following: XmlTkNoMultiLvlLbl, XmlTkTickLabelSkipFr, XmlTkTickMarkSkipFr, XmlTkMajorUnitFr, XmlTkMinorUnitFr, XmlTkTickLabelPositionFr, XmlTkBaseTimeUnitFr, XmlTkFormatCodeFr, XmlTkMajorUnitTypeFr, XmlTkMinorUnitTypeFr</p>

Value	Meaning
0x0005	<p>The record that contains this structure MUST be in a sequence of records that conforms to the CHARTFORMATS rule and appears directly before the End record. This sequence of records specifies the chart element targeted by the token structures in this chain.</p> <p>The token structures in the chain specify chart properties and MUST be one of the following: XmlTkShowDLblsOverMax, XmlTkBackWallThicknessFr, XmlTkFloorThicknessFr, XmlTkDispBlanksAsFr, XmlTkStartSurface, XmlTkFormatCodeFr, XmlTkSpb, XmlTkTpb, XmlTkEndSurface</p>
0x000F	<p>The CrtMIFr record that contains this structure MUST be in a sequence of records that conforms to the LD rule. This sequence of records specifies the chart element targeted by the token structures in this chain.</p> <p>The token structures in the chain specify Legend properties and MUST be: XmlTkOverlay</p>
0x0013	<p>The record that contains this structure MUST be in a sequence of records that conforms to the SS rule. This sequence of records specifies the chart element targeted by the token structures in this chain.</p> <p>The token structures in the chain specify data marker properties and MUST be: XmlTkSymbolFr</p>
0x0016	<p>The record that contains this structure MUST be in a sequence of records that conforms to the CHARTFORMATS rule and appears directly before the End record. This sequence of records specifies the chart element targeted by the token structures in this chain.</p> <p>The token structures in the chain specify Plot area properties and MUST be: XmlTkPieComboFrom12Fr</p>
0x0019	<p>The record that contains this structure MUST be in a sequence of records that conforms to the ATTACHEDLABEL within the CHARTFORMATS rule. This sequence of records specifies the chart element targeted by the token structures in this chain.</p> <p>The token structures in the chain specify Chart title properties and MUST be: XmlTkOverlay</p>
0x0037	<p>The record that contains this structure MUST be in a sequence of records that conformed to the CHARTFORMATS rule and appears directly before the End record. This sequence of records specifies the chart element targeted by the token structures in this chain.</p> <p>The token structures in the chain specify View 3-D properties and MUST be one of the following: XmlTkRANGAxOffFr, XmlTkPerspectiveFr, XmlTkRotYFr, XmlTkRotXFr, XmlTkHeightPercent</p>

chainRecords (variable): A chain of structures that specifies the additional properties or property overrides for a given chart element, specified by the **xmltkParent** field. The token sequence **ABNF** for each **xmltkParent** is specified according to the following table:

xmltkParent	ABNF
0x0001	chainRecords = [XmlTkMaxFr] [XmlTkMinFr] [XmlTkLogBaseFr]
0x0002	chainRecords = [XmlTkStyle] [XmlTkThemeOverride] [XmlTkColorMappingOverride]
0x0004	chainRecords = [XmlTkNoMultiLvlLbl] [XmlTkTickLabelSkipFr] [XmlTkTickMarkSkipFr] [XmlTkMajorUnitFr] [XmlTkMinorUnitFr] [XmlTkTickLabelPositionFr] [XmlTkBaseTimeUnitFr] [XmlTkFormatCodeFr] [XmlTkMajorUnitTypeFr]

xmItkParent	ABNF
	[XmItkMinorUnitTypeFrt]
0x0005	chainRecords = [XmItkShowDLblsOverMax] [XmItkBackWallThicknessFrt] [XmItkFloorThicknessFrt] [XmItkDispBlanksAsFrt] [SURFACE] SURFACE = XmItkStartSurface [XmItkFormatCodeFrt [XmItkSpb]] [XmItkTpb] XmItkEndSurface
0x000F	chainRecords = [XmItkOverlay]
0x0013	chainRecords = [XmItkSymbolFrt]
0x0016	chainRecords = [XmItkPieComboFrom12Frt]
0x0019	chainRecords = [XmItkOverlay]
0x0037	chainRecords = [XmItkRANGAxOffFrt] [XmItkPerspectiveFrt] [XmItkRotYFrt] [XmItkRotXFrt] [XmItkHeightPercent]

2.5.305 XmItkColorMappingOverride

The **XmItkColorMappingOverride** structure specifies the color mapping override for a [chart](#), stored as an **XML stream** (section [2.1.7.22](#)) as specified in [\[ECMA-376\]](#) Part 4, section 4.4.1.7.

0	1	2	3	4	5	6	7	8	9	10	11	12	13	14	15	16	17	18	19	20	21	22	23	24	25	26	27	28	29	30	31
rgThemeOverride (variable)																															
...																															

rgThemeOverride (variable): An [XmItkBlob](#) that specifies the color mapping override. The **rgThemeOverride.xtHeader.xmItkTag** MUST be equal to 0x0034. The **XML stream** (section [2.1.7.22](#)) is specified in [\[ECMA-376\]](#) Part 4, section 4.4.1.7, and compressed by the compression algorithm specified in [\[RFC1951\]](#).

2.5.306 XmItkDispBlanksAsFrt

The **XmItkDispBlanksAsFrt** structure specifies how blank data entries are represented. This structure MUST only be present if the current [chart](#) does not support displaying blank entries. The following [chart group](#) types do not support blank entries: area chart group, pie chart group, line chart group with **fStacked** field of the [Line](#) record equal to 1, bar of pie chart group, pie of pie chart group and doughnut chart group.

0	1	2	3	4	5	6	7	8	9	10	11	12	13	14	15	16	17	18	19	20	21	22	23	24	25	26	27	28	29	30	31
blanksAs																															

...

blanksAs (6 bytes): An [XmITkToken](#) that specifies how blank data entries are represented on the current chart. The **blanksAs.xtHeader.xmITkTag** field MUST be equal to 0x0066. This field overrides the **mdBlank** field of the [ShtProps](#) record that specifies the current **sheet**. The **blanksAs.dValue** field MUST be a value from the following table:

Value	Meaning
0x0067	Specifies that blank values are shown as a gap.
0x0069	Specifies that blank values are spanned with a line. The current chart group type MUST be area chart group or line chart group with fStacked field of the Line record equal to 1.

2.5.307 XmITkDouble

The **XmITkDouble** structure specifies an Xnum (section [2.5.342](#)) value for the **xmltkChain** field of the [CrtMIFrt](#) record.

0	1	2	3	4	5	6	7	8	9	10	11	12	13	14	15	16	17	18	19	20	21	22	23	24	25	26	27	28	29	30	31
xtHeader																															
unused																															
dValue																															
...																															

xtHeader (4 bytes): An [XmITkHeader](#). The **xtHeader.drType** field MUST be equal to 0x03.

unused (4 bytes): Undefined, and MUST be ignored.

dValue (8 bytes): An Xnum that specifies the value of this structure.

2.5.308 XmITkDWord

The **XmITkDWord** structure specifies an integer value for the **xmltkChain** field of the [CrtMIFrt](#) record.

0	1	2	3	4	5	6	7	8	9	10	11	12	13	14	15	16	17	18	19	20	21	22	23	24	25	26	27	28	29	30	31
xtHeader																															
dValue																															

xtHeader (4 bytes): An [XmITkHeader](#). The **xtHeader.drType** field MUST be equal to 0x04.

dValue (4 bytes): A signed integer that specifies the value of this structure.

2.5.309 XmITkEnd

The **XmITkEnd** structure specifies the end of a group of structures for the **xmltkChain** field of the [CrtMIFrt](#) record.

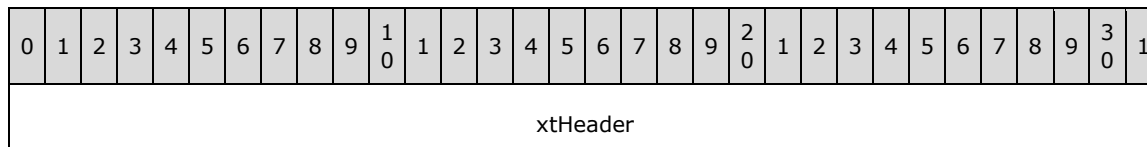

xtHeader (4 bytes): An [XmITkHeader](#). The **xtHeader.drType** field MUST be equal to 0x01.

2.5.310 XmITkEndSurface

The **XmITkEndSurface** structure specifies the end of a back wall definition. The back wall is the **wall** that is parallel to the **category (2) axis**. This structure defines additional properties for the back wall of the current [chart](#). This structure MUST have a corresponding [XmITkStartSurface](#) structure.

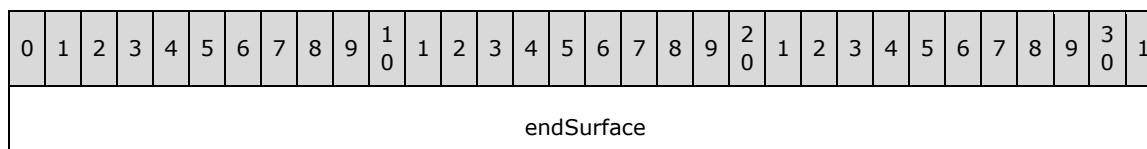

endSurface (4 bytes): An [XmITkEnd](#) that specifies the end of a back wall definition. The **endSurface.xtHeader.xmltkTag** field MUST be equal to the **startSurface.xtHeader.xmltkTag** of the corresponding [XmITkStartSurface](#) structure.

2.5.311 XmITkFloorThicknessFrt

The **XmITkFloorThicknessFrt** structure specifies the thickness of the **floor** of a [chart](#) as a percentage of the height of the 3-D **plot area**. This structure MUST only be present if the floor thickness is greater than 0. MUST only be specified if the chart contains a [Chart3d](#) record.



floorThickness (8 bytes): An [XmITkDWord](#) that specifies the thickness of the floor of the chart as a percentage of the height of the 3-D plot area. The **floorThickness.dValue** MUST be greater than 0, and less than or equal to 100. The **floorThickness.xtHeader.xmltkTag** field MUST be equal to 0x0036.

2.5.312 XmlTkFormatCodeFr

The **XmlTkFormatCodeFr** structure specifies the number formatting to use for the [axis](#) labels on the date axis. This structure MUST only be present if the **fUnlinkedIfmt** field of the [BRAI](#) record that corresponds to the axis labels of the date axis is set to 0. This structure MUST only be present if the **fDateAxis** of the corresponding [AxcExt](#) record is equal to 1.

0	1	2	3	4	5	6	7	8	9	1	0	1	2	3	4	5	6	7	8	9	2	0	1	2	3	4	5	6	7	8	9	3	0	1
stFormat (variable)																																		
...																																		

stFormat (variable): An [XmlTkString](#) that specifies the number formatting to use for the axis labels of the date axis. Details about the structure of **number format** string are specified in [\[ECMA-376\]](#) Part 4: Markup Language Reference, section 3.8.31. This field overrides the **ifmt** field of the corresponding BRAI record when the **fUnlinkedIfmt** field of the BRAI record is set to 0. The **stFormat.xtHeader.xmlTkTag** field MUST be equal to 0x0064.

2.5.313 XmlTkHeader

The **XmlTkHeader** structure specifies the header of the **XML** token data types.

0	1	2	3	4	5	6	7	8	9	1	0	1	2	3	4	5	6	7	8	9	2	0	1	2	3	4	5	6	7	8	9	3	0	1
drType										unused										xmlTkTag														

drType (1 byte): An unsigned integer that specifies the data type. MUST be specified by the containing structure.

unused (1 byte): Undefined, and MUST be ignored.

xmlTkTag (2 bytes): An unsigned integer that specifies the token identifier. MUST be specified by the containing structure.

2.5.314 XmlTkHeightPercent

The **XmlTkHeightPercent** structure specifies the height of the **plot area** as a percentage of its width. This record MUST NOT exist for a pie [chart group](#), and MUST only exist when a [Chart3d](#) record is present and the **f3DScaling** field of the Chart3d record is equal to 1.

0	1	2	3	4	5	6	7	8	9	1	0	1	2	3	4	5	6	7	8	9	2	0	1	2	3	4	5	6	7	8	9	3	0	1
heightPercent (16 bytes)																																		
...																																		
...																																		

heightPercent (16 bytes): An [XmITkDouble](#) that specifies the height of the plot area as a percentage of its width. **heightPercent.dValue** MUST be greater than or equal to 5, MUST be less than the maximum value of Xnum , and SHOULD <190> be less than or equal to 500. This field overrides the **pcHeight** field of the Chart3d record in the [chart sheet](#) substream. The **heightPercent.xtHeader.xmITkTag** MUST be equal to 0x0065.

2.5.315 XmITkLogBaseFrt

The **XmITkLogBaseFrt** structure specifies the logarithmic base of a logarithmic value [axis](#). This structure MUST only be present if the **fLog** field of the corresponding [ValueRange](#) record is set to 1, and the logarithmic base is not 10.

0	1	2	3	4	5	6	7	8	9	1	0	1	2	3	4	5	6	7	8	9	2	0	1	2	3	4	5	6	7	8	9	3	0	1
logScale (16 bytes)																																		
...																																		
...																																		

logScale (16 bytes): An [XmITkDouble](#) that specifies the logarithmic base of a logarithmic value axis. **logScale.dValue** MUST be greater than or equal to 2, and less than or equal to 1000. The **logScale.xtHeader.xmITkTag** field MUST be equal to 0x0000. This field overrides the base, 10, of the logarithmic value axis when the **fLog** field of the corresponding ValueRange record is set to 1.

2.5.316 XmITkMajorUnitFrt

The **XmITkMajorUnitFrt** structure specifies the value of the interval at which the **major tick marks** are displayed on the date [axis](#). This structure MUST only be present if the **fAutoBase** field of the corresponding [AxcExt](#) record is set to 1 and the **fDateAxis** field of the corresponding AxcExt record is equal to 1.

0	1	2	3	4	5	6	7	8	9	1	0	1	2	3	4	5	6	7	8	9	2	0	1	2	3	4	5	6	7	8	9	3	0	1
majorUnit (16 bytes)																																		
...																																		
...																																		

majorUnit (16 bytes): An [XmITkDouble](#) that specifies a value that can override the **catMajor** field of the corresponding AxcExt record. The **majorUnit.xtHeader.xmITkTag** field MUST be equal to 0x0053. This field overrides the **catMajor** field of the corresponding AxcExt record when the **fAutoMajor** field of the AxcExt record is set to 1.

2.5.317 XmITkMajorUnitTypeFrt

The **XmITkMajorUnitTypeFrt** structure specifies the value of the unit of time used by the interval at which the **major tick marks** are displayed on the date [axis](#). This structure MUST only be present if the **fAutoBase** field of the corresponding [AxcExt](#) record is set to 1 and the **fDateAxis** of the corresponding AxcExt record is equal to 1.

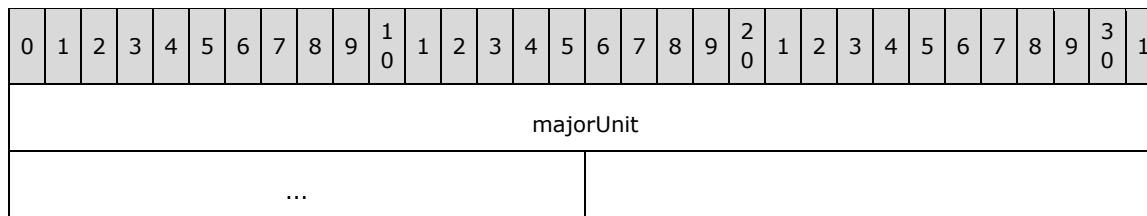

majorUnit (6 bytes): An [XmlTkToken](#) that specifies a value that can override the **duMajor** field of the corresponding AxcExt record. The **majorUnit.xtHeader.xmlTkTag** field MUST be equal to 0x006A. This field overrides the **duMajor** field of the corresponding AxcExt record when the **fAutoMajor** field of the AxcExt record is set to 1. The **majorUnit.dValue** MUST be a value from the following table:

Value	Meaning
0x0060	Time value is measured in days.
0x0061	Time value is measured in months.
0x0062	Time value is measured in years.

2.5.318 XmlTkMaxFrt

The **XmlTkMaxFrt** structure specifies the maximum value on a logarithmic value [axis](#). This structure MUST only be present if the **fAutoMax** field of the corresponding [ValueRange](#) record is set to 0, the **fLog** field of the corresponding ValueRange record is set to 1, and the logarithmic base is not 10.

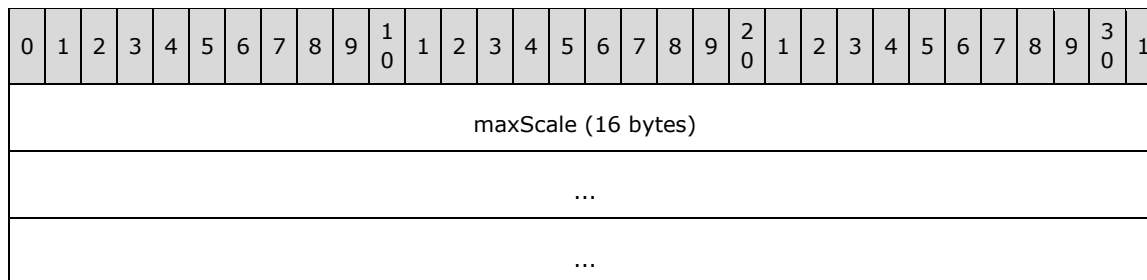

maxScale (16 bytes): An [XmlTkDouble](#) that specifies the maximum value on a logarithmic value axis. The **maxScale.dValue** MUST be greater than the value specified in the **minScale.dValue** field of the [XmlTkMinFrt](#) structure. The **maxScale.xtHeader.xmlTkTag** field MUST be equal to 0x0055. This field overrides the **numMax** field of the associated ValueRange record when the **fLog** field of the ValueRange record is set to 1.

2.5.319 XmlTkMinFrt

The **XmlTkMinFrt** structure specifies the minimum value on a logarithmic value [axis](#). This structure MUST only be present if the **fAutoMin** field of the corresponding [ValueRange](#) record is set to 0, the **fLog** field of the corresponding ValueRange record is set to 1, and the logarithmic base is not 10.

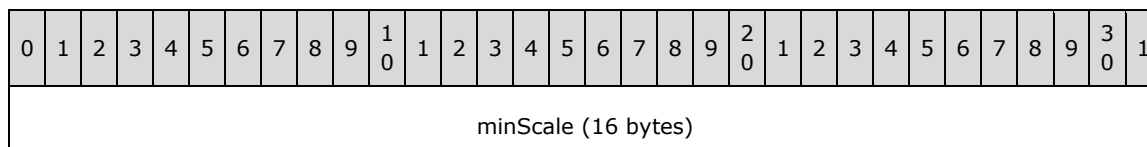

...
...

minScale (16 bytes): An [XmITkDouble](#) that specifies the minimum value on a logarithmic value axis. The **minScale.dValue** MUST be less than the value specified in the **maxScale.dValue** field of the [XmITkMaxFrt](#) structure. The **minScale.xtHeader.xmlTkTag** field MUST be equal to 0x0056. This field overrides the **numMin** field of the associated ValueRange record when the **fLog** field of the ValueRange record is set to 1.

2.5.320 XmITkMinorUnitFrt

The **XmITkMinorUnitFrt** structure specifies the value of the interval at which the **minor tick marks** are displayed on the date [axis](#). This structure MUST only be present if the **fAutoBase** field of the corresponding [AxcExt](#) record is set to 1 and the **fDateAxis** of the corresponding AxcExt record is equal to 1.

0	1	2	3	4	5	6	7	8	9	1	0	1	2	3	4	5	6	7	8	9	2	0	1	2	3	4	5	6	7	8	9	3	0	1
minorUnit (16 bytes)																																		
...																																		
...																																		

minorUnit (16 bytes): An [XmITkDouble](#) that specifies a value that can override the **catMinor** field of the corresponding AxcExt record. The **minorUnit.xtHeader.xmlTkTag** field MUST be equal to 0x0054. This field overrides the **catMinor** field of the corresponding AxcExt record when the **fAutoMinor** field of the AxcExt record is set to 1.

2.5.321 XmITkMinorUnitTypeFrt

The **XmITkMinorUnitTypeFrt** structure specifies the value of the unit of time used by the interval at which the **major tick marks** are displayed on the date [axis](#). This structure MUST only be present if the **fAutoBase** field of the corresponding [AxcExt](#) record is set to 1 and the **fDateAxis** of the corresponding AxcExt record is equal to 1.

0	1	2	3	4	5	6	7	8	9	1	0	1	2	3	4	5	6	7	8	9	2	0	1	2	3	4	5	6	7	8	9	3	0	1
minorUnit																																		
...																																		

minorUnit (6 bytes): An [XmITkToken](#) that specifies a value that can override the **duMinor** field of the corresponding AxcExt record. The **minorUnit.xtHeader.xmlTkTag** field MUST be equal to 0x006B. This field overrides the **duMinor** field of the corresponding AxcExt record when the **fAutoMinor** field of the AxcExt record is set to 1. The **minorUnit.dValue** MUST be a value from the following table:

Value	Meaning
0x0060	Time value is measured in days.

Value	Meaning
0x0061	Time value is measured in months.
0x0062	Time value is measured in years.

2.5.322 XmiTkNoMultiLvILbl

The **XmiTkNoMultiLvILbl** structure specifies whether multi-level labeling is enabled for a **category (2) axis**.

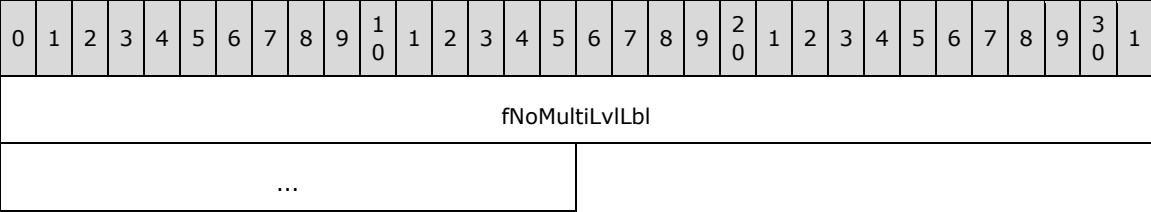

fNoMultiLvILbl (6 bytes): An **XmiTkBool** that specifies whether single-level labeling is enabled for a category (2) axis. The **fNoMultiLvILbl.xtHeader.xmiTkTag** field MUST be equal to 0x002E. MUST be a value from the following table:

Value	Meaning
0	Multi-level labeling is enabled for a category (2) axis.
1	Single-level labeling is enabled for a category (2) axis.

2.5.323 XmiTkOverlay

The **XmiTkOverlay** structure specifies whether the **chart legend** and title can overlap or can overlap other chart elements.

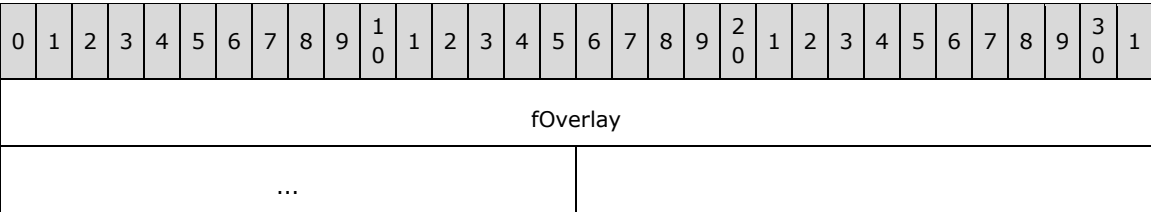

fOverlay (6 bytes): An **XmiTkBool** that specifies whether the chart legend or title can overlap or can overlap other chart elements. **fOverlay.dValue** MUST be 1. The **fOverlay.xtHeader.xmiTkTag** field MUST be equal to 0x002F.

2.5.324 XmlTkPerspectiveFr

The **XmlTkPerspectiveFr** structure specifies the angle of the field of view for the **plot area**. This structure MUST exist only for bar [chart groups](#) and pie chart groups, and MUST exist only when the [chart](#) contains a [Chart3d](#) record and the **fPerspective** field of the Chart3d record equal to 1. When the angle of the field of view is the default angle, 20, this structure MUST NOT be present.

0	1	2	3	4	5	6	7	8	9	1	0	1	2	3	4	5	6	7	8	9	2	0	1	2	3	4	5	6	7	8	9	3	0	1
perspectiveAngle																																		
...																																		

perspectiveAngle (8 bytes): An [XmlTkDWord](#) that specifies the angle of the field of view. The **perspectiveAngle.xtHeader.xmlTkTag** field MUST be 0x004D. The value of **perspectiveAngle.dValue** field MUST equal to two times the view angle and MUST be greater than or equal to 0 and less than or equal to 200. This field overrides the **pcDist** field of the Chart3d record in the [chart sheet](#) substream.

2.5.325 XmlTkPieComboFrom12Fr

The **XmlTkPieComboFrom12Fr** structure specifies whether the current [chart](#) contains multiple [chart groups](#) and one of them is a pie chart group.

0	1	2	3	4	5	6	7	8	9	1	0	1	2	3	4	5	6	7	8	9	2	0	1	2	3	4	5	6	7	8	9	3	0	1
fPieCombo																																		
...																																		

fPieCombo (6 bytes): An [XmlTkBool](#) that specifies whether the current chart contains multiple chart groups and one of them is a pie chart group. **fPieCombo.dValue** MUST be 1. The **fPieCombo.xtHeader.xmlTkTag** field MUST be equal to 0x005E.

2.5.326 XmlTkRangAxOffFr

The **XmlTkRangAxOffFr** structure specifies whether the **plot area** is rendered with a vanishing point, rather than rendered at right angles. This structure MUST only exist for a bar [chart group](#), and only when the [chart](#) contains a [Chart3d](#) record is present and the **fPerspective** field of the Chart3d record equal to 1.

0	1	2	3	4	5	6	7	8	9	1	0	1	2	3	4	5	6	7	8	9	2	0	1	2	3	4	5	6	7	8	9	3	0	1
fRightAngAxOff																																		
...																																		

fRightAngAxOff (6 bytes): An [XmlTkBool](#) that specifies whether the plot area is rendered with a vanishing point. This field corresponds to the **fPerspective** field of Chart3d record, and it MUST only be present when the **fPerspective** field of the Chart3d record in the [chart sheet](#) substream is

equal to 1. The **fRightAngAxOff.dValue** field MUST be equal to 0x01. The **fRightAngAxOff.xtHeader.xmlTkTag** field MUST be equal to 0x0050.

2.5.327 XmlTkRotXFrt

The **XmlTkRotXFrt** structure specifies the clockwise rotation, in degrees, of the 3-D **plot area** around a horizontal line through the center of the 3-D plot area. It MUST only be present when the **chart** contains a **Chart3d**, and as specified by the **fPerspective** field of the Chart3d record. This structure MUST only exist for a bar **chart group**, and only when the rotation angle is less than 0 or greater than 44.

0	1	2	3	4	5	6	7	8	9	10	1	2	3	4	5	6	7	8	9	20	1	2	3	4	5	6	7	8	9	30	1
rotationX																															
...																															

rotationX (8 bytes): An **XmlTkDWord** that specifies the rotation angle. The **rotationX.xtHeader.xmlTkTag** field MUST be 0x004E. The **rotationX.dValue** field MUST be either greater than or equal to -90 and less than 0, or greater than or equal to 45 and less than or equal to 90. It overrides the **anElev** field of the Chart3d record in the **chart sheet** substream.

2.5.328 XmlTkRotYFrt

The **XmlTkRotYFrt** structure specifies the clockwise rotation, in degrees, of the 3-D **plot area** around a vertical line through the center of the 3-D plot area. MUST exist only when the **chart** contains a **Chart3d** record, and as specified by the **fPerspective** field of the Chart3d record. This record MUST only exist for a bar **chart group**, and only when the rotation angle is greater than 44.

0	1	2	3	4	5	6	7	8	9	10	1	2	3	4	5	6	7	8	9	20	1	2	3	4	5	6	7	8	9	30	1
rotationY																															
...																															

rotationY (8 bytes): An **XmlTkDWord** that specifies the rotation angle. The **rotationY.xtHeader.xmlTkTag** field MUST be 0x004F. The **rotationY.dValue** field MUST be greater than or equal to 45, and less than or equal to 359. It overrides the **anRot** field of the Chart3d record **chart sheet** substream.

2.5.329 XmlTkShowDLblsOverMax

The **XmlTkShowDLblsOverMax** structure specifies whether **data labels** with values over the maximum value of the value **axis** of the **chart** are displayed.

0	1	2	3	4	5	6	7	8	9	10	1	2	3	4	5	6	7	8	9	20	1	2	3	4	5	6	7	8	9	30	1
fVDLOverMax																															
...																															

fVDLOverMax (6 bytes): An [XmITkBool](#) that specifies whether data labels with values over the maximum value of the value axis of the chart are displayed. The **fVDLOverMax.xtHeader.xmITkTag** field MUST be equal to 0x005B.

2.5.330 XmITkSpb

The **XmITkSpb** structure specifies the shape formatting information of a [chart](#) object, stored as an **XML stream** (section [2.1.7.22](#)) as defined in [\[ECMA-376\]](#) Part 4, section 5.7.2.198.

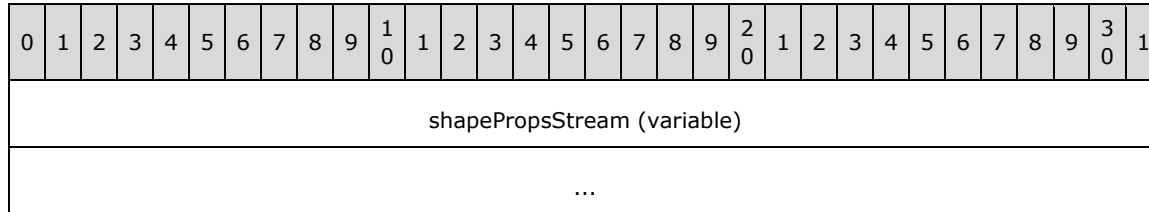

shapePropsStream (variable): An [XmITkBlob](#) that specifies the shape formatting information. The **shapePropsStream.xtHeader.xmITkTag** MUST be equal to 0x001E. The **XML stream** (section [2.1.7.22](#)) is defined in [\[ECMA-376\]](#) Part 4, section 5.7.2.198, and compressed by the compression algorithm specified in [\[RFC1951\]](#).

2.5.331 XmITkStart

The **XmITkStart** structure specifies the start of a group of structures for the **xmITkChain** field of the [CrtMIFrt](#) record.

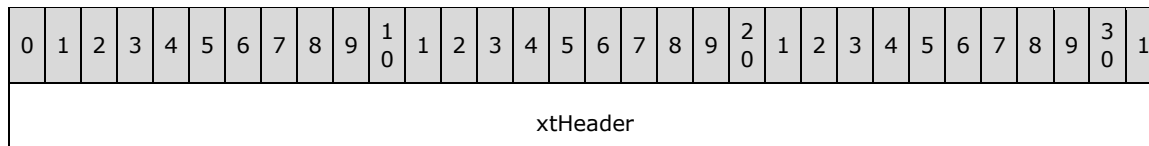

xtHeader (4 bytes): An [XmITkHeader](#). The **xtHeader.drType** field MUST be equal to 0x00.

2.5.332 XmITkStartSurface

The **XmITkStartSurface** structure specifies the beginning of a back wall. The back wall definition applies to the current [chart](#) back wall. The back wall is the **wall** that is parallel to the **category (2) axis**. This structure MUST have a corresponding [XmITkEndSurface](#) structure.

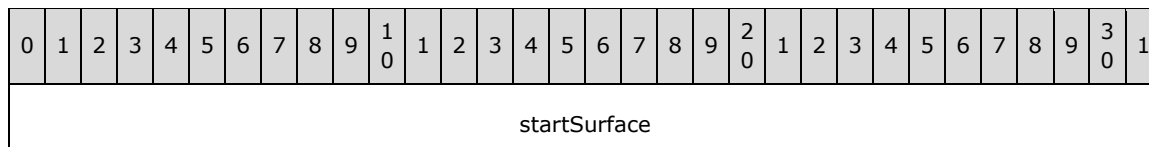

startSurface (4 bytes): An [XmITkStart](#) that specifies which surface is defined. The **startSurface.xtHeader.xmITkTag** field MUST be equal to a value from the following table:

Value	Meaning
0x0059	The side wall is being defined.

2.5.333 XmlTkString

The **XmlTkString** structure specifies a **Unicode** string value for the **xmltkChain** field of the [CrtMIFrt](#) record.

0	1	2	3	4	5	6	7	8	9	10	11	12	13	14	15	16	17	18	19	20	21	22	23	24	25	26	27	28	29	30	31
xtHeader																															
cchValue																															
rgbValue (variable)																															
...																															

xtHeader (4 bytes): An [XmlTkHeader](#). The **xtHeader.drType** field MUST be equal to 0x05.

cchValue (4 bytes): An unsigned integer that specifies the count of characters of the **rgbValue** field.

rgbValue (variable): An array of Unicode characters. The size of the array, in characters, is specified by the **cchValue** field. The size of the field, in bytes, MUST equal the result of the following formula:

$$\text{cchValue} * 2.$$

2.5.334 XmlTkStyle

The **XmlTkStyle** structure specifies which built-in **chart style** is applied to the chart. This structure MUST only exist when a non-default chart style is used.

0	1	2	3	4	5	6	7	8	9	10	11	12	13	14	15	16	17	18	19	20	21	22	23	24	25	26	27	28	29	30	31
chartStyle																															
...																															

chartStyle (8 bytes): An [XmlTkDWord](#) that specifies a one-based index into the [Style](#) record of the [Global substream](#). MUST be greater than or equal to 1 and less than or equal to 48. MUST NOT be 2. The **chartStyle.xmltkHeader.xmltkTag** MUST be equal to 0x0003.

2.5.335 XmlTkSymbolFrt

The **XmlTkSymbolFrt** structure specifies which built-in marker **style** is applied to the **data markers** of the current line, scatter or radar [chart group](#).

0	1	2	3	4	5	6	7	8	9	10	11	12	13	14	15	16	17	18	19	20	21	22	23	24	25	26	27	28	29	30	31
markerStyle																															
...																															

markerStyle (6 bytes): An [XmitkToken](#) that specifies the built-in marker style applied to the data markers of the current line, scatter or radar chart group. The **markerStyle.xtHeader.xmitkTag** MUST be equal to 0x0022. It overrides the **imk** field of the [MarkerFormat](#) record when the **fAuto** field of the MarkerFormat record is set to 1. The **markerStyle.dValue** field MUST be equal to a value from the following table:

Value	Meaning
0x0023	Specifies nothing shall be drawn at each data point .
0x0024	Specifies a diamond shall be drawn at each data point.
0x0025	Specifies a square shall be drawn at each data point.
0x0026	Specifies a triangle shall be drawn at each data point.
0x0027	Specifies an X shall be drawn at each data point.
0x0028	Specifies a star shall be drawn at each data point.
0x0029	Specifies a dot shall be drawn at each data point.
0x002A	Specifies a dash shall be drawn at each data point.
0x002B	Specifies a circle shall be drawn at each data point.
0x002C	Specifies a plus shall be drawn at each data point.

2.5.336 XmitkThemeOverride

The **XmitkThemeOverride** structure specifies theme definition override for a [chart](#), stored as an **XML stream** (section [2.1.7.22](#)) as defined in [\[ECMA-376\]](#) Part 4, section 5.1.8.12.

0	1	2	3	4	5	6	7	8	9	10	1	2	3	4	5	6	7	8	9	20	1	2	3	4	5	6	7	8	9	30	1		
rgThemeOverride (variable)																																	
...																																	

rgThemeOverride (variable): An [XmitkBlob](#) that specifies the theme override. The **rgThemeOverride.xtHeader.xmitkTag** MUST be equal to 0x0033. The **XML stream** (section [2.1.7.22](#)) is defined in [\[ECMA-376\]](#) Part 4, section 5.1.8.12, and compressed by the compression algorithm specified in [\[RFC1951\]](#).

2.5.337 XmitkTickLabelPositionFrt

The **XmitkTickLabelPositionFrt** structure specifies that [axis](#) labels on a series axis are center-aligned.

0	1	2	3	4	5	6	7	8	9	10	1	2	3	4	5	6	7	8	9	20	1	2	3	4	5	6	7	8	9	30	1		
xmitkHigh																																	
...																																	

xmltkHigh (6 bytes): An [XmlTkToken](#) that specifies that axis labels on a series axis are center-aligned. This is equivalent to the **vat** field of the corresponding [Text](#) record being set to 0x02. The **xmltkHigh.dValue** MUST be set to 0x005D. The **xmltkHigh.xtHeader.xmlTkTag** field MUST be equal to 0x005C. This value overrides the **vat** field of the corresponding Text record when the **vat** field of the Text record is not set to 0x02.

2.5.338 XmlTkTickLabelSkipFrT

The **XmlTkTickLabelSkipFrT** structure specifies the interval of labels on the **category (2) axis** or series axis. This structure MUST only be present if the **catLabel** field of the corresponding [CatSerRange](#) record is not set to 1.

0	1	2	3	4	5	6	7	8	9	10	1	2	3	4	5	6	7	8	9	20	1	2	3	4	5	6	7	8	9	30	1
nInterval																															
...																															

nInterval (8 bytes): An [XmlTkDWord](#) that specifies the number of categories (2) between axis labels on a category (2) axis or series axis. The **nInterval.xtHeader.xmlTkTag** field MUST be equal to 0x0051. It overrides the **catLabel** field of the corresponding CatSerRange record when the **catLabel** field of the CatSerRange record is not set to 1.

2.5.339 XmlTkTickMarkSkipFrT

The **XmlTkTickMarkSkipFrT** structure specifies the number of **major tick marks** to skip on a **category (2) axis** or a [series](#) axis. This structure MUST only be present if the **catMark** field of the corresponding [CatSerRange](#) record is not set to 1.

0	1	2	3	4	5	6	7	8	9	10	1	2	3	4	5	6	7	8	9	20	1	2	3	4	5	6	7	8	9	30	1
nInterval																															
...																															

nInterval (8 bytes): An [XmlTkDWord](#) that specifies the number of major tick marks to skip on a category (2) axis or a series axis. The **nInterval.xtHeader.xmlTkTag** field MUST be equal to 0x0052. It overrides the **catMark** field of the corresponding CatSerRange record when the **catMark** field of the CatSerRange record is not set to 1.

2.5.340 XmlTkToken

The **XmlTkToken** structure specifies a constant value for the **xmltkChain** field of the [CrtMIFrT](#) record.

0	1	2	3	4	5	6	7	8	9	10	1	2	3	4	5	6	7	8	9	20	1	2	3	4	5	6	7	8	9	30	1
xtHeader																															
dValue																															

xtHeader (4 bytes): An [XmlTkHeader](#). The **xtHeader.drType** field MUST be equal to 0x06.

dValue (2 bytes): An unsigned integer that specifies the value of this structure.

2.5.341 XmlTkTpb

The **XmlTkTpb** structure specifies text formatting information for the current chart **XML** element, stored as an **XML stream** (section 2.1.7.22), as specified in [ECMA-376] Part 4, section 5.7.2.217.

0	1	2	3	4	5	6	7	8	9	10	11	12	13	14	15	16	17	18	19	20	21	22	23	24	25	26	27	28	29	30	31
textPropsStream (variable)																															
...																															

textPropsStream (variable): An [XmlTkBlob](#) that specifies the text formatting information. The **textPropsStream.xtHeader.xmlTkTag** MUST be equal to 0x0020. The **XML stream** (section 2.1.7.22) is specified in [ECMA-376] Part 4, section 5.7.2.217, and compressed by the compression algorithm specified in [RFC1951].

2.5.342 Xnum

Xnum is a 64-bit binary **floating-point number** as specified in [IEEE754]. This value MUST NOT [<191>](#) be infinity, denormalized, not-a-number (NaN), nor negative zero.

2.5.343 XORObfuscation

The **XORObfuscation** structure specifies the **XOR obfuscation**.

0	1	2	3	4	5	6	7	8	9	10	11	12	13	14	15	16	17	18	19	20	21	22	23	24	25	26	27	28	29	30	31
key																verificationBytes															

key (2 bytes): An unsigned integer that specifies the **obfuscation key**. See [MS-OFFCRYPTO], 2.3.6.2 section, the first step of initializing XOR array where it describes the generation of 16-bit XorKey value.

verificationBytes (2 bytes): An unsigned integer that specifies the password verification identifier. See [Password Verifier Algorithm](#).

2.5.344 XTI

The **XTI** structure specifies a [supporting link](#) and scope information about that supporting link.

0	1	2	3	4	5	6	7	8	9	10	11	12	13	14	15	16	17	18	19	20	21	22	23	24	25	26	27	28	29	30	31
iSupBook																itabFirst															
itabLast																															

iSupBook (2 bytes): An unsigned integer that specifies the zero-based index of a [SupBook](#) record in the collection of SupBook records in the [Globals Substream ABNF](#). The referenced SupBook

specifies the supporting link referenced by this structure. This value MUST be less than the number of SupBook records in this file.

itabFirst (2 bytes): A signed integer that specifies the scope of the supporting link, and if a scope is specified, the first **sheet** in the scope of that supporting link. If the type of supporting link specified by the **cch** and **virtPath** fields of the SupBook record is same-sheet referencing, add-in referencing, DDE **data source** referencing, or **OLE** data source referencing, then no scope is specified and this value MUST be -2. Otherwise, this field MUST contain a value from the following table:

Value	Meaning
-2	Workbook -level reference that applies to the entire workbook.
-1	Sheet-level reference. The first sheet in the reference could not be found.
>= 0	Sheet-level reference. This specifies the first sheet in the reference. If the supporting link type is unused or external workbook referencing, then this value specifies the zero-based index of an XLUnicodeString in the rgst field of the SupBook record specified in iSupBook . This XLUnicodeString specifies the name of the first sheet within the external workbook that is in scope. This sheet MUST be a worksheet or macro sheet . If the supporting link type is self-referencing, then this value specifies the zero-based index of a BoundSheet8 record in the Globals Substream ABNF that specifies the first sheet within the scope of this reference. This sheet MUST be a worksheet or a macro sheet.

itabLast (2 bytes): A signed integer that specifies the scope of the supporting link, and if a scope is specified, the last sheet in the scope of that supporting link. If the type of supporting link specified by the **cch** and **virtPath** fields of the SupBook record is same-sheet referencing, add-in referencing, **DDE** data source referencing, or OLE data source referencing, then no scope is specified and this value MUST be -2. Otherwise, this field MUST contain a value from the following table:

Value	Meaning
-2	Workbook-level reference that applies to the entire workbook. MUST NOT be used if itabFirst is not equal to -2.
-1	Sheet-level reference. The last sheet in the reference could not be found. SHOULD NOT <192> be used if itabFirst is equal to -2.
>= 0	Sheet-level reference. This specifies the last sheet in the reference. MUST NOT be used if itabFirst is equal to -2. If the supporting link type is unused or referring to an external workbook, then this value specifies the zero-based index of an XLUnicodeString in the rgst field of the SupBook record specified in iSupBook . This XLUnicodeString specifies the name of the last sheet within the external workbook that is in scope. This sheet MUST be a worksheet or macro sheet. If the supporting link type is self-referencing, then this value specifies the zero-based index of a BoundSheet8 record in the Globals Substream ABNF that specifies the last sheet within the scope of this reference. This sheet MUST be a worksheet or a macro sheet.

2.6 XCB Structures

2.6.1 CTBWRAPPER

The **CTBWRAPPER** structure specifies a custom toolbar wrapper. This is the root record of the XCB binary stream where custom toolbars are stored.

0	1	2	3	4	5	6	7	8	9	10	11	12	13	14	15	16	17	18	19	20	21	22	23	24	25	26	27	28	29	30	31
ctbSet (14 bytes)																															
...																															
...																															
...																rCTB (variable)															
...																															

ctbSet (14 bytes): This is a structure of type [CTBS](#).

rCTB (variable): Zero-based index array of [CTB](#) structures. The number of elements in the array MUST be equal to **ctbSet.ctb**.

2.6.2 CTBS

The **CTBS** record specifies the number of custom toolbars stored in the file and the number of available **toolbar views**.

0	1	2	3	4	5	6	7	8	9	10	11	12	13	14	15	16	17	18	19	20	21	22	23	24	25	26	27	28	29	30	31
bSignature										bVersion										reserved1											
reserved2																reserved3															
ctb																ctbViews															
ictbView																															

bSignature (1 byte): An unsigned integer that specifies the toolbar set signature number. MUST be 0x01.

bVersion (1 byte): An unsigned integer that specifies the toolbar set version number. MUST be 0x01.

reserved1 (2 bytes): MUST be zero and MUST be ignored.

reserved2 (2 bytes): MUST be zero and MUST be ignored.

reserved3 (2 bytes): MUST be zero and MUST be ignored.

ctb (2 bytes): An unsigned integer that specifies the number of elements in the **rCTB** array of the [CTBWRAPPER](#) structure that contains this structure. The value MUST be greater than 0x0000.

ctbViews (2 bytes): An unsigned integer that specifies the number of available toolbar views. MUST be 0x0003. There are three view modes and therefore each toolbar has three available views. The view modes are shown in the following table:

View mode number	Meaning
0	Normal view
1	Full screen view
2	Web-only view<193>

ictbView (2 bytes): An unsigned integer that specifies the view mode number that the application was in at the time the file was saved. MUST be equal to 0x0000 or 0x0001.

2.6.3 CTB

The **CTB** record specifies a custom toolbar.

0	1	2	3	4	5	6	7	8	9	10	11	12	13	14	15	16	17	18	19	20	21	22	23	24	25	26	27	28	29	30	31
tb (variable)																															
...																															
rVisualData (60 bytes, optional)																															
...																															
...																															
ectbid																															
rTBC (variable)																															
...																															

tb (variable): Structure of type TB, as specified in [\[MS-OSHARED\]](#) section 2.3.1.6, that contains toolbar information.

rVisualData (60 bytes): A zero-based index array of TBVisualData structures, specified in [\[MS-OSHARED\]](#) section 2.3.1.9. The number of elements in this array MUST be equal to the value of the **ctbViews** field of the [CTBS](#) structure contained by the [CTBWRAPPER](#) structure that contains this structure. The index of each structure in the array corresponds to a view mode number. Refer to the following table for the meaning of each TBVisualData, specified in [\[MS-OSHARED\]](#) section 2.3.1.9, structure according to its position in this array:

Index of structure in array	Meaning of TBVisualData, specified in [MS-OSHARED] section 2.3.1.9, structure
0	Contains the visual information for this toolbar to be used when the application is in Normal view .
1	Contains the visual information for this toolbar to be used when the application is in Full screen view .
2	Contains the visual information for this toolbar to be used when the application is

Index of structure in array	Meaning of TBVisualData, specified in [MS-OSHARED] section 2.3.1.9, structure
	in Web-only view .

ectbid (4 bytes): A signed integer that specifies the application's specific custom toolbar identifier. Value MUST be 0x00000FFF.

rTBC (variable): Number of elements in the array MUST be equal to **tb.cCL**.

2.6.4 TBC

The **TBC** record specifies a **toolbar control**.

0	1	2	3	4	5	6	7	8	9	10	11	12	13	14	15	16	17	18	19	20	21	22	23	24	25	26	27	28	29	30	31
tbch (variable)																															
...																															
tbcCmd (optional)																															
tbcd (variable)																															
...																															

tbch (variable): Structure of type TBCHeader, as specified in [MS-OSHARED] section 2.3.1.10, that specifies toolbar control header information.

tbcCmd (4 bytes): Structure of type **TBCCmd**. This field MUST only exist when **tbch.tcid** is not equal to 0x0001, 0x06CC (1740), 0x03D8 (984), 0x03EC (1004), or 0x1051 (4177), and the value of **tbch.tct** equals one of the values in the following table:

Value of tbch.tct	Meaning
0x01	Button control
0x02	Edit control
0x03	Dropdown control
0x04	ComboBox control
0x06	SplitDropDown control
0x07	OCXDropDown control
0x08	GraphicDropDown control
0x0A	Popup control
0x0C	ButtonPopup control
0x0D	SplitButtonPopup control
0x0E	SplitButtonMRUPopup control
0x0F	Label control
0x15	Pane control

tbcd (variable): Structure of type TBCData, as specified in [MS-OSHARED] section 2.3.1.13, that specifies toolbar control data. MUST exist if **tbch.tct** is not equal to 0x16. MUST NOT exist if **tbch.tct** equals 0x16.

2.6.5 TBCCmd

The **TBCCmd** record specifies a command identifier for a **toolbar control**.

0	1	2	3	4	5	6	7	8	9	10	11	12	13	14	15	16	17	18	19	20	21	22	23	24	25	26	27	28	29	30	31
cmdID																A	B	cmdType					C	reserved3							

cmdID (2 bytes): A signed integer that specifies the command identifier for this toolbar control. Value MUST be in one of the tables specified in sections 2.3, 2.4, 2.5, 2.6, 2.7, and 2.8 of [\[MS-CTXLS\]](#).

A - fHideDrawing (1 bit): A bit that specifies whether the toolbar control is visible if it is disabled. A value of 1 specifies that the toolbar control is not visible if it is disabled. MUST only be used if **cmdType** equals 0x10 or 0x14. MUST be 0 if **cmdType** is not equal to 0x10 and is not equal to 0x14.

B - reserved1 (1 bit): MUST be zero and MUST be ignored.

cmdType (5 bits): An unsigned integer that specifies the command type for this toolbar control. Value MUST be in the following table:

Value	Meaning
0x00	Toolbar control uses a toolbar control grid command identifier. Value of cmdType MUST be one of the values listed in [MS-CTXLS] section 2.8.
0x01	Toolbar control uses a toolbar control command identifier. Value of cmdType MUST be one of the values listed in [MS-CTXLS] section 2.4.
0x02	Toolbar control uses a general command identifier. Value of cmdType MUST be one of the values listed in [MS-CTXLS] section 2.3.
0x03	Toolbar control uses a menu toolbar control command identifier. Value of cmdType MUST be one of the values listed in [MS-CTXLS] section 2.5.
0x05	Toolbar control uses a toolbar command identifier. Value of cmdType MUST be one of the values listed in [MS-CTXLS] section 2.7. The value of the tbch.tct field of the TBC structure that contains this structure MUST be equal to one of the following values: 0x0A, 0x0C, 0x0D, or 0x0E.
0x07	Toolbar control uses a menu toolbar command identifier. Value of cmdType MUST be one of the values listed in [MS-CTXLS] section 2.6. The value of the tbch.tct field of the TBC structure that contains this structure MUST be equal to one of the following values: 0x0A, 0x0C, 0x0D, or 0x0E.
0x08	Toolbar control command is determined by using the value of the tbch.tcid field of the TBC structure that contains this structure.

0x10	Toolbar control uses an MSODGCID specifying a drawing command, as specified in [MS-ODRAW] .
0x14	Toolbar control uses an MSODGCID specifying a drawing command, as specified in [MS-ODRAW] .

C - reserved2 (1 bit): MUST be zero and MUST be ignored.

reserved3 (8 bits): MUST be zero and MUST be ignored.

2.7 Algorithms

2.7.1 Application Data For VtHyperlink

The following algorithm specifies how hyperlink properties ([\[MS-OSHARED\]](#) section 2.3.3.1.18) that are associated with a **range** of cells or shapes in a document construct their **dwApp** structure **member (1)** value.

1. If the hyperlink is associated with a shape [\[MS-ODRAW\]](#) section 2.2.31, the **dwApp** value MUST be 0xFFFFFFFF.
2. Otherwise the hyperlink MUST be associated with a range of cells on a **sheet**, and the **dwApp** value is computed as follows:
3. Set an unsigned 2-byte integer (wHLIndex) equal to the zero-based index of the [HLink](#) structure or [HLinkTooltip](#) structure in the sheet that the hyperlink is associated with.
4. Set an unsigned 2-byte integer (wWSIndex) equal to the zero-based index of the sheet in the document on which this range of cells that the hyperlink is associated with is defined.
5. The value of **dwApp** MUST be equal to the bitwise OR of wWSIndex shifted 16 bits to the high order and wHLIndex.

Example: `dwApp = (wWSIndex << 16) | wHLIndex;`

3 Structure Examples

This section contains examples of some of the most commonly used data structures in MS-XLS files. The examples are meant to be a starting point for an implementer learning the file format. They are not meant to cover all records in the file format.

The following conventions are followed for all of the examples, unless noted otherwise:

- The order of the records, structures, and fields within the example match their corresponding order in the file format.
- The examples begin with the first record relevant to the example and end with the last record relevant to the example. An example cannot be used as a complete and standalone MS-XLS file.
- The examples are self-contained and contiguous; no records or structures are omitted in the middle of an example.
- Undefined and ignored fields are not included in the field explanations.
- Offsets for records and structures are omitted because these values can vary depending on how the files are created and what optional records applications choose to include in files.
- In the structure diagrams for the examples, the types of arrays are meant for illustration only and can be disregarded.

3.1 Conditional Formatting

This example shows conditional formatting applied to **cell** A2 with a "between" condition to make the text red when the value is greater than or equal to 1.5, and less than or equal to 2.5.

The first record in this example is a [CondFmt](#) record, which specifies beginning of a collection of [CF](#) records and defines the **range** of cells to which the conditional formatting rule applies. The CF record follows next in this example, defining that conditional formatting rule.

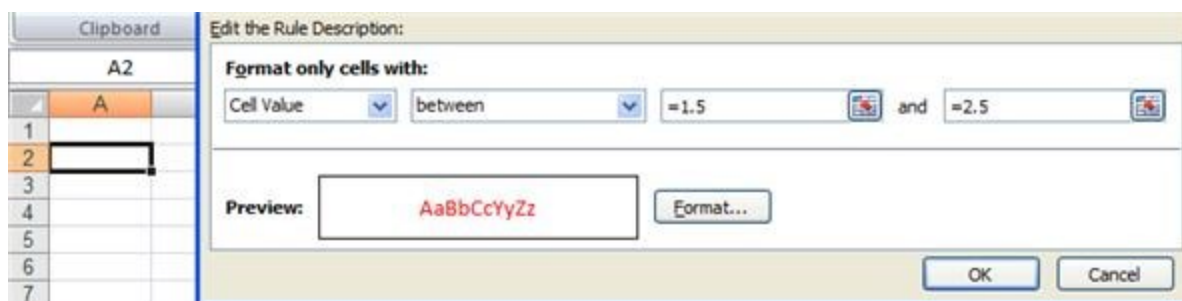

Figure 19: Conditional formatting in this example within a sheet

3.1.1 Conditional Formatting: CondFmt

The first record in this example, [CondFmt](#), specifies beginning of a collection of [CF](#) records and defines the **range** of **cells** to which the conditional formatting rule applies.

Size	Structure	Value
0016	CondFmt - CondFmt	
0002	USHORT - ccf	0x0001

Size	Structure	Value
1 bit	USHORT - fToughRecalc	0x0
15 bits	USHORT - nID	0x0000
0008	Ref8U - refBound	
0002	RwU - rwFirst	
0002	USHORT - rw	0x0001
0002	RwU - rwLast	
0002	USHORT - rw	0x0001
0002	ColU - colFirst	
0002	USHORT - col	0x0000
0002	ColU - colLast	
0002	USHORT - col	0x0000
000A	SqRefU - sqref	
0002	USHORT - cref	0x0001
0008	RgRef8U - rgrefs	
0008	Ref8U - ref[0]	
0002	RwU - rwFirst	
0002	USHORT - rw	0x0001
0002	RwU - rwLast	
0002	USHORT - rw	0x0001
0002	ColU - colFirst	
0002	USHORT - col	0x0000
0002	ColU - colLast	
0002	USHORT - col	0x0000

Figure 20: Structure of CondFmt

ccf: 0x0001 specifies that there is one CF record in the collection that follows this record.

fToughRecalc: 0x0 specifies that the appearance of the cell does not require significant processing.

nID: 0x0000 specifies the identifier for this record.

refBound: A Ref8U structure specifies the bounds of the set of cells to which the rules are applied.

refBound.rwFirst: An RwU structure that specifies the index of the first row in the range.

refBound.rwFirst.rw: 0x0001 specifies that the range starts in row two of the **worksheet**.

refBound.rwLast: A RwU structure that specifies index of the last row in the range.

refBound.rwLast.rw: 0x0001 specifies that the range ends in row two of the worksheet.

refBound.colFirst: A ColU structure that specifies the index of the first column in the range.

refBound.colFirst.col: 0x0000 specifies that the range starts in column A of the worksheet.

refBound.colLast: A ColU structure that specifies the index of the last column in the range.

refBound.colLast.col: 0x0000 specifies that the range ends in column A of the worksheet.

sqref: An SqRefU structure that specifies the cells to which the conditional formatting rules apply.

sqref.cref: 0x0001 specifies that there is one Ref8U structure in **rgrefs**.

sqref.rgrefs.ref[0]: This is the first Ref8U structure that specifies the range of cells on the sheet where the **conditional formatting** rules apply.

sqref.rgrefs.ref[0].rwFirst.rw: 0x0001 specifies the range starts in row two of the worksheet.

sqref.rgrefs.ref[0].rwLast.rw: 0x0001 specifies the range ends in row two of the worksheet.

sqref.rgrefs.ref[0].colFirst.col: 0x0000 specifies the range starts in column A of the worksheet.

sqref.rgrefs.ref[0].colLast.col: 0x0000 specifies the range ends in column A of the worksheet.

3.1.2 Conditional Formatting: CF

The next record in this example, [CF](#), specifies a conditional formatting rule.

Size	Structure	Value
0094	CF - Cf	
0001	BYTE - ct	0x01
0001	BYTE - cp	0x01
0002	USHORT - cce1	0x0009
0002	USHORT - cce2	0x0009
007C	DXFN - rgbdx	
1 bit	DWORD - alchNin	0x1
1 bit	DWORD - alcvNin	0x1
1 bit	DWORD - wrapNin	0x1
1 bit	DWORD - trotNin	0x1
1 bit	DWORD - kintoNin	0x1
1 bit	DWORD - cIndentNin	0x1
1	DWORD	0x1

Size	Structure	Value
1 bit	- fShrinkNin ch	
1 bit	DWORD - fMergeCell Inch	0x1
1 bit	DWORD - lockedNin ch	0x1
1 bit	DWORD - hiddenNin ch	0x1
1 bit	DWORD - glLeftNin ch	0x1
1 bit	DWORD - glRightNin ch	0x1
1 bit	DWORD - glTopNin ch	0x1
1 bit	DWORD - glBottomNin ch	0x1
1 bit	DWORD - glDiagDown Nin ch	0x1
1 bit	DWORD - glDiagUpNin ch	0x1
1 bit	DWORD - flsNin ch	0x1
1 bit	DWORD - icvFNin ch	0x1
1 bit	DWORD - icvBNin ch	0x1
1 bit	DWORD - ifmtNin ch	0x1
1 bit	DWORD - fifntNin ch	0x1
1 bit	DWORD - unused1	0x1
3 bits	DWORD - reserved1	0x0
1 bit	DWORD - ibitAtrNum	0x0
1 bit	DWORD - ibitAtrFnt	0x1

Size	Structure	Value
1 bit	DWORD - ibitAtrAlc	0x0
1 bit	DWORD - ibitAtrBdr	0x0
1 bit	DWORD - ibitAtrPat	0x0
1 bit	DWORD - ibitAtrProt	0x0
1 bit	DWORD - iReadingOrderNinch	0x0
1 bit	WORD - ffmtUser	0x0
1 bit	WORD - unused2	0x1
1 bit	WORD - fNewBorder	0x0
12 bits	WORD - reserved2	0x000
1 bit	WORD - fZeroInited	0x0
0076	DXFFntD - dxffntd	
0001	BYTE - cchFont	0x00
003F	unused - unused	0x000100010000000000E03F000000000000E03F0100630075006D0065006E0074002000570072006900740065007200000000000000001040006DC00580303FF
0010	Stxp - stxp	
0004	LONG - twpHeight	0xFFFFFFFF
0004	Ts - ts	
1 bit	DWORD - unused1	0x0
1 bit	DWORD - ftsItalic	0x0
5 bits	DWORD - unused2	0x00
1 bit	DWORD - ftsStrikeout	0x0
24 bits	DWORD - unused3	0x000000
0002	SHORT - bls	0x0000

Si ze	Structure	Value
00 02	SHORT - sss	0x0000
00 01	BYTE - uls	0x00
00 01	BYTE - bFamily	0x00
00 01	BYTE - bCharSet	0x00
00 01	BYTE - unused	0x00
00 04	LONG - icvFore	0x0000000A
00 04	LONG - reserved	0x00000000
00 04	^{Ts -} tsNinch	
1 bit	DWORD - unused1	0x0
1 bit	DWORD - ftsItalic	0x1
5 bit s	DWORD - unused2	0x06
1 bit	DWORD - ftsStrikeout	0x1
24 bit s	DWORD - unused3	0x000000
00 04	DWORD - fSssNinch	0x00000001
00 04	DWORD - fUlsNinch	0x00000001
00 04	DWORD - fBlsNinch	0x00000001
00 04	DWORD - unused2	0x00000001
00 04	LONG - ich	0x00000000
00 04	LONG - cch	0x7FFFFFFF
00 02	FontIndex - iFnt	

Size	Structure	Value
0002	USHORT - ifnt	0x0001
0009	CFParsedFormulaNoCCE - rgce1	
0009	Rgce - rgce	
0009	Ptg - Ptg[0]	
0009	PtgNum - PtgNum	
7 bits	BYTE - ptg	0x1F
1 bit	BYTE - reserved0	0x0
0008	Double - value	0x3FF8000000000000
0009	CFParsedFormulaNoCCE - rgce2	
0009	Rgce - rgce	
0009	Ptg - Ptg[0]	
0009	PtgNum - PtgNum	
7 bits	BYTE - ptg	0x1F
1 bit	BYTE - reserved0	0x0
0008	Double - value	0x4004000000000000

Figure 21: Structure of Cf

ct: 0x01 specifies that the **conditional formatting** rule requires two inputs. The inputs, **rgce1** and **rgce2**, are evaluated with the comparison function specified in the **cp** field. If the result of the evaluation is TRUE, the conditional formatting rule is applied.

cp: 0x01 specifies that the comparison function evaluates to TRUE if the **cell** value is greater than or equal to the value of the **rgce1** field and less than or equal to the value of the **rgce2** field.

cce1: 0x0009 specifies that the size of the **rgce1** field is 9 bytes.

cce2: 0x0009 specifies that the size of the **rgce2** field is 9 bytes.

rgbdf: A DXFN structure that specifies the formatting that is applied if the defined condition evaluates to TRUE.

rgbdf.alchNinch: 0x1 specifies that **rgbdf.dxfalc.alc** is ignored.

rgbdf.alcvNinch: 0x1 specifies that **rgbdf.dxfalc.alcv** is ignored.

rgbdf.wrapNinch: 0x1 specifies that **rgbdf.dxfalc.fWrap** is ignored.

rgbdf.trotNinch: 0x1 specifies that **rgbdf.dxfalc.trot** is ignored.

rgbdf.kintoNinch: 0x1 specifies that **rgbdf.dxfalc.fJustLast** is ignored.

rgbdf.cIndentNinch: 0x1 specifies that **rgbdf.dxfalc.cIndent** and **rgbdf.dxfalc.iIndent** are ignored.

rgbdf.fShrinkNinch: 0x1 specifies that **rgbdf.dxfalc.fShrinkToFit** is ignored.

rgbdf.fMergeCellNinch: 0x1 specifies that **rgbdf.dxfalc.fMergeCell** is ignored.

rgbdf.lockedNinch: 0x1 specifies that **rgbdf.dxfprot.fLocked** is ignored.

rgbdf.hiddenNinch: 0x1 specifies that **rgbdf.dxfprot.fHidden** is ignored.

rgbdf.glLeftNinch: 0x1 specifies that **rgbdf.dxfbdr.dgLeft** and **rgbdf.dxfbdr.icvLeft** are ignored.

rgbdf.glRightNinch: 0x1 specifies that **rgbdf.dxfbdr.dgRight** and **rgbdf.dxfbdr.icvRight** are ignored.

rgbdf.glTopNinch: 0x1 specifies that the properties for the top **border** of the cell can be updated and that **rgbdf.dxfbdr.dgTop** and **rgbdf.dxfbdr.icvTop** are ignored.

rgbdf.glBottomNinch: 0x1 specifies that **rgbdf.dxfbdr.dgBottom** and **rgbdf.dxfbdr.icvBottom** are ignored.

rgbdf.glDiagDownNinch: 0x1 specifies that **rgbdf.dxfbdr.bitDiagDown** is ignored.

rgbdf.glDiagUpNinch: 0x1 specifies that **rgbdf.dxfbdr.bitDiagUp** is ignored. Because **rgbdf.glDiagDownNinch** is also set to 0x1, **rgbdf.dxfbdr.dgDiag** and **rgbdf.dxfbdr.icvDiag** are ignored.

rgbdf.flSinch: 0x1 specifies that **rgbdf.dxfpat.flS** is ignored.

rgbdf.icvFNinch: 0x1 specifies that **rgbdf.dxfpat.icvForeground** is ignored.

rgbdf.icvBNinch: 0x1 specifies that **rgbdf.dxfpat.icvBackground** is ignored.

rgbdf.ifmtNinch: 0x1 specifies that **rgbdf.dxfnum.ifmt** is ignored.

rgbdf.fIfntNinch: 0x1 specifies that **rgbdf.dxffntd.ifnt** is ignored.

rgbdf.ibitAtrNum: 0x0 specifies that the **number format** is not part of this structure.

rgbdf.ibitAtrFnt: 0x1 specifies that **font** information is a part of this structure.

rgbdf.ibitAtrAlc: 0x0 specifies that alignment information is not a part of this structure.

rgbdf.ibitAtrBdr: 0x0 specifies that **border formatting** information is not a part of this structure.

rgbdf.ibitAtrPat: 0x0 specifies that pattern information is not a part of this structure.

rgbdf.ibitAtrProt: 0x0 specifies that rotation information is not a part of this structure.

rgbdf.iReadingOrderNinch: 0x1 specifies that **rgbdf.dxfalc.iReadingOrder** is ignored.

rgbdf.fIfmtUser: 0x0 specifies that the number format is not a user-defined **format string**.

rgbdf.fNewBorder: 0x0 specifies that the border formats apply to all cells in the **range**.

rgbdf.fZeroInited: 0x0 specifies that **rgbdf.dxfalc.iReadingOrder** is undefined and not taken into account.

rgbdf.dxffntd: A DXFFntD structure that specifies the font information used for formatting.

rgbdf.dxffntd.cchFont: 0x00 specifies the number of characters in the font name string.

rgbdf.dxffntd.stxp: This specifies the formatting attributes of the font.

rgbdf.dxffntd.stxp.twpHeight: 0xFFFFFFFF specifies that this value is ignored.

rgbdf.dxffntd.stxp.ts: A Ts structure that specifies additional formatting attributes.

rgbdf.dxffntd.stxp.ts.ftsItalic: 0x1 is ignored because **rgbdf.dxffntd.tsNinch.ftsItalic** is 0x1.

rgbdf.dxffntd.stxp.ts.ftsStrikeout: 0x0 is ignored because **rgbdf.dxffntd.tsNinch.ftsStrikeout** is 0x1.

rgbdf.dxffntd.stxp.blis: 0x0000 specifies that the font is normal weight.

rgbdf.dxffntd.stxp.sss: 0x0000 specifies that the font is normal script.

rgbdf.dxffntd.stxp.uls: 0x00 specifies that the font is not underlined.

rgbdf.dxffntd.stxp.bFamily: 0x00 specifies the **font family**.

rgbdf.dxffntd.stxp.bCharSet: 0x00 specifies the font **character set**.

rgbdf.dxffntd.icvFore: 0x0000000A specifies that the font color is red.

rgbdf.dxffntd.tsNinch: A Ts structure that specifies how the value of **rgbdf.dxffntd.stxp.ts** is interpreted.

rgbdf.dxffntd.tsNinch.ftsItalic: 0x1 specifies that the value of **rgbdf.dxffntd.stxp.ts.ftsItalic** is ignored.

rgbdf.dxffntd.tsNinch.ftsStrikeout: 0x1 specifies that the value of **rgbdf.dxffntd.stxp.ts.ftsStrikeout** is ignored.

rgbdf.dxffntd.fSssNinch: 0x00000001 specifies that **rgbdf.dxffntd.stxp.sss** is ignored.

rgbdf.dxffntd.fUlsNinch: 0x00000001 specifies that **rgbdf.dxffntd.stxp.uls** is ignored.

rgbdf.dxffntd.fBlisNinch: 0x00000001 specifies that **rgbdf.dxffntd.stxp.blis** is ignored.

rgbdf.dxffntd.ich: 0x00000000 specifies that the font formatting is applied starting from the first character.

rgbdf.dxffntd.cch: 0x7FFFFFFF specifies that the font formatting applies to 2147483647 characters.

rgbdf.dxffntd.iFnt: 0x0001 is ignored because **rgbdf.fIfntNinch** is 0x1.

rgce1: A CFParsedFormulaNoCCE structure that specifies the first operand of the comparison.

rgce1.rgce: An Rgce that specifies an array of [Ptgs](#).

rgce1.rgce.Ptg[0]: A Ptg that specifies a formula element.

rgce1.rgce.Ptg[0].PtgNum.ptg: 0x1F specifies that this Ptg is a floating point value.

rgce1.rgce.Ptg[0].PtgNum.value: 0x3FF8000000000000 specifies a numeric value of 1.5.

rgce2: A CFParsedFormulaNoCCE structure that specifies the second operand of the comparison.

rgce2.rgce: A Rgce structure that specifies an array of Ptg.

rgce2.rgce.Ptg[0]: A Ptg that specifies a formula element.

rgce2.rgce.Ptg[0].PtgNum.ptg: 0x1F specifies that this Ptg is a floating point value.

rgce2.rgce.Ptg[0].PtgNum.value: 0x4004000000000000 specifies a numeric value of 2.5.

3.2 Defined Name

This example shows a **workbook**-level **defined name**, *MyName*, that points to the **cell** E4 on the second **sheet**. A defined name is specified by a **Lbl** record, which is a part of the **Globals Substream** (not included in this example for brevity). This example includes the **ExternSheet** record referenced by the Lbl record, and the **SupBook** record referenced by the ExternSheet record.

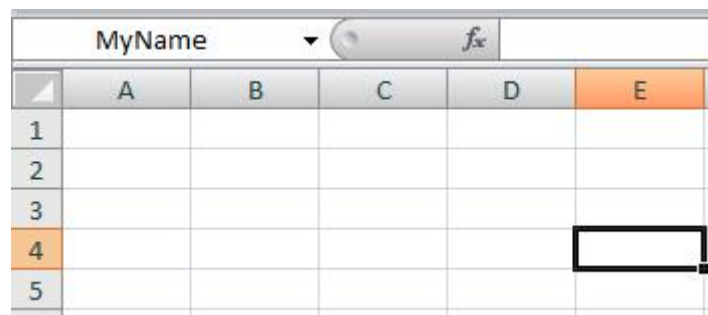

Figure 22: Defined name in this example within a sheet

3.2.1 Defined Name: Lbl

The first record in this example, **Lbl**, stores the **defined name**.

Size	Structure	Value
001C	Lbl - Lbl	
1 bit	USHORT - fHidden	0x0
1 bit	USHORT - fFunc	0x0
1 bit	USHORT - fOB	0x0
1 bit	USHORT - fProc	0x0
1 bit	USHORT - fCalcExp	0x0
1 bit	USHORT - fBuiltin	0x0
6 bits	USHORT - fGrp	0x00
1 bit	USHORT - reserved1	0x0
1 bit	USHORT - fPublished	0x0

Size	Structure	Value
1 bit	USHORT - fWorkbookParam	0x0
1 bit	USHORT - reserved2	0x0
0001	BYTE - chKey	0x00
0001	BYTE - cch	0x06
0002	SHORT - cce	0x0007
0002	SHORT - reserved3	0x0000
0002	USHORT - itab	0x0000
0001	BYTE - reserved4	0x00
0001	BYTE - reserved5	0x00
0001	BYTE - reserved6	0x00
0001	BYTE - reserved7	0x00
0007	XLUnicodeStringNoCch - Name	MyName
0007	NameParsedFormula - rgce	
0007	Ptg - Ptg[0]	
0007	PtgRef3d - PtgRef3d	
5 bits	BYTE - ptg	0x1A
2 bits	PtgDataType - type	0x1
1 bit	BYTE - reserved	0x0
0002	USHORT - ixti	0x0000
0004	RcellLoc - loc	
0002	RwU - row	
0002	USHORT - rw	0x0003
0002	ColRelU - column	
0002	USHORT - col	0x0004

Figure 23: Structure of Lbl

fHidden: 0x0 specifies that the defined name is visible in the list of defined names.

fFunc: 0x0 specifies that the defined name does not represent an **XML**.

fOB: 0x0 specifies that the defined name does not represent a **VBA macro**.

fProc: 0x0 specifies that the defined name does not represent a macro.

fCalcExp: 0x0 specifies that the defined name does not represent a function that could return an array.

fBuiltin: 0x0 specifies that the defined name does not represent a **built-in name**.

fGrp: 0x00 specifies the **function category** for the defined name is "All".

fPublished: 0x0 specifies that this defined name is not **published**.

fWorkbookParam: 0x0 specifies that this defined name is not a **workbook** parameter.

chKey: 0x00 specifies there is no shortcut key for the macro represented by the defined name.

chc: 0x06 specifies that there are six characters in the **Name** field.

cce: 0x0007 specifies that the length of the **rgce** field is 7 bytes.

itab: 0x0000 specifies that the defined name is not local to a **sheet**.

Name: *MyName* specifies the name of the defined name.

rgce: A NameParsedFormula that specifies the formula (section [2.2.2](#)) that represents the defined name.

rgce.Ptg[0].PtgRef3d.ptg: 0x1A specifies that this Ptg is of type PtgRef3d.

rgce.Ptg[0].PtgRef3d.type: 0x1 specifies that this Ptg is a reference to a **range**.

rgce.Ptg[0].PtgRef3d.ixti: 0x0000 specifies that this range refers to the sheet specified by the first [XTI](#) element in the [ExternSheet](#) record.

rgce.Ptg[0].PtgRef3d.loc.row.rw: 0x0003 specifies that the referenced **cell** is in row four of the **worksheet**.

rgce.Ptg[0].PtgRef3d.loc.column.col: 0x0004 specifies that the referenced cell is in column E of the worksheet.

3.2.2 Defined Name: ExternSheet

The next record in this example is an [ExternSheet](#) record. This record defines the set of **sheets** that are referenced by this **workbook**. It is included in this example because the **ixti** field in the [Lb](#) record points to the [XTI](#) structure within this record.

Size	Structure	Value
0008	ExternSheet - ExternSheet	
0002	USHORT - cXTI	0x0001
0006	RgXTI - rgXTI	
0006	XTI - xti[0]	
0002	USHORT - iSupBook	0x0000
0002	SHORT - itabFirst	0x0001
0002	SHORT - itabLast	0x0001

Figure 24: Structure of ExternSheet

cXTI: 0x0001 specifies that there is one XTI record in the **rgXTI** array.

rgXTI.xti[0].iSupBook: 0x0000 specifies the reference to the first [SupBook](#) record in the [global substream](#).

rgXTI.xti[0].itabFirst: 0x0001 specifies that the first sheet referenced by the **defined name** is the second sheet in the workbook (Sheet2). The related [BoundSheet8](#) record is omitted for brevity.

rgXTI.xti[0].itabLast: 0x0001 specifies that the last sheet referenced by the defined name is the second sheet in the workbook (Sheet2).

3.2.3 Defined Name: SupBook

The next record in this example, [SupBook](#), stores information about a **workbook** that is referenced by this workbook.

Size	Structure	Value
0004	SupBook - SupBook	
0002	USHORT - ctab	0x0003
0002	USHORT - cch	0x0401

Figure 25: Structure of SupBook

ctab: 0x0003 specifies that there are three **sheets** in the referenced workbook.

cch: 0x0401 specifies that this record defines a self-referencing [supporting link](#).

3.3 Table

This example shows the records that make up a **table**. The following figure shows a possible implementation of the table discussed in this example:

	A	B	C	D	E	F
1						
2						
3						
4			Item	Price	Sales Tax	
5			Bicycle	50	4	
6			Backpack	24	1.92	
7			Shoes	60	4.8	
8						
9						

Figure 26: Table in this example within a sheet

3.3.1 Table: FeatHdr11

The first record in this example is a [FeatHdr11](#) record that appears in the [worksheet substream](#) (the worksheet substream is not included in this example for brevity). This record stores common information about all the tables on this **sheet**.

Size	Structure	Value
001D	FeatHdr11 - FeatHdr11	
000C	FrtHeader - frt	
0002	USHORT - rt	0x0871

Size	Structure	Value
0002	FrtFlags - grbitFrt	
1 bit	USHORT - fFrtRef	0x0
1 bit	USHORT - fFrtAlert	0x0
14 bits	USHORT - reserved	0x0000
0008	RESERVED - reserved	0x0000000000000000
0002	SharedFeatureType - isf	0x0005
0001	BYTE - reserved1	0x01
0004	DWORD - reserved2	0xFFFFFFFF
0004	DWORD - reserved3	0xFFFFFFFF
0004	DWORD - idListNext	0x00000002
0002	USHORT - reserved4	0x0000

Figure 27: Structure of FeatHdr11

frt: This structure specifies a future version record type FrtHeader.

frt.rt: 0x0871 specifies that this record belongs to a record of type FeatHdr11.

frt.grbitFrt: Stores attributes for this record.

frt.grbitFrt.fFrtRef: 0x0000 specifies that this record does not specify a **range of cells**.

frt.grbitFrt.fFrtAlert: 0x0000 specifies not to alert the user of possible problems when saving the file as an earlier version of the file format.

isf: 0x0005 specifies type Table.

idListNext: 0x00000002 specifies the next identifier to try when assigning a unique identifier to a new **table**.

3.3.2 Table: Feature11

The next record in this example, [Feature11](#), specifies information about this **table** on this **sheet**.

Size	Structure	Value
0116	Feature11 - Feature11	
000C	FrtRefHeaderU - frtRefHeaderU	
0002	USHORT - rt	0x0872
0002	FrtFlags - grbitFrt	
1 bit	USHORT - fFrtRef	0x1
1 bit	USHORT - fFrtAlert	0x0
14 bits	USHORT - reserved	0x0000

Size	Structure	Value
0008	Ref8U - ref8	
0002	RwU - rwFirst	
0002	USHORT - rw	0x0003
0002	RwU - rwLast	
0002	USHORT - rw	0x0006
0002	ColU - colFirst	
0002	USHORT - col	0x0002
0002	ColU - colLast	
0002	USHORT - col	0x0004
0002	USHORT - isf	0x0005
0001	BYTE - reserved1	0x00
0004	DWORD - reserved2	0x00000000
0002	USHORT - cref2	0x0001
0004	DWORD - cbFeatData	0x00000000
0002	USHORT - reserved3	0x0000
0008	REFS2 - refs2	
0008	Ref8U - ref[0]	
0002	RwU - rwFirst	
0002	USHORT - rw	0x0003
0002	RwU - rwLast	
0002	USHORT - rw	0x0006
0002	ColU - colFirst	
0002	USHORT - col	0x0002
0002	ColU - colLast	
0002	USHORT - col	0x0004
00F3	FeatUnion5 - rgbFeat	
00F3	TableFeatureType - TableFeature	
0004	SourceType - It	0x00000000
0004	DWORD - idList	0x00000001
0004	DWORD - crwHeader	0x00000001
0004	DWORD - crwTotals	0x00000000

Size	Structure	Value
0004	DWORD - idFieldNext	0x00000004
0004	ULONG - cbFSData	0x00000040
0002	USHORT - rupBuild	0x0000
0002	USHORT - unused1	0x0000
1 bit	DWORD - unused2	0x0
1 bit	DWORD - fAutoFilter	0x1
1 bit	DWORD - fPersistAutoFilter	0x1
1 bit	DWORD - fShowInsertRow	0x0
1 bit	DWORD - fInsertRowInsCells	0x0
1 bit	DWORD - fLoadPldwIdDeleted	0x0
1 bit	DWORD - fShownTotalRow	0x0
1 bit	DWORD - reserved1	0x0
1 bit	DWORD - fNeedsCommit	0x0
1 bit	DWORD - fSingleCell	0x0
1 bit	DWORD - reserved2	0x0
1 bit	DWORD - fApplyAutoFilter	0x1
1 bit	DWORD - fForceInsertToBeVis	0x0
1 bit	DWORD - fCompressedXml	0x0
1 bit	DWORD - fLoadCSPName	0x0
1 bit	DWORD - fLoadPldwIdChanged	0x0
4 bits	DWORD - verXL	0xB
1 bit	DWORD - fLoadEntryId	0x1
1 bit	DWORD - fLoadPllstclInvalid	0x0
1 bit	DWORD - fGoodRupBld	0x0
1 bit	DWORD - unused3	0x0
1 bit	DWORD - fPublished	0x0
7 bits	DWORD - unused2	0x00
0004	ULONG - lPosStmCache	0x00000000
0004	ULONG - cbStmCache	0x00000000
0004	ULONG - cchStmCache	0x00000000
0004	LEMMode - lem	0x00000000

Size	Structure	Value
0010	rgb - rgbHashParam	0x00000000000000000000000000000000
0008	XLUnicodeString - rgbName	List1
0002	USHORT - cFieldData	0x0003
0004	XLUnicodeString - entryId	1
00A5	Feat11FieldDataArray - fieldData	
0035	Feat11FieldDataItem - Feat11FieldDataItem[0]	
0004	DWORD - idField	0x00000001
0004	DWORD - lfdt	0x00000000
0004	DWORD - lfxidt	0x00000000
0004	DWORD - ilta	0x00000000
0004	DWORD - cbFmtAgg	0x00000000
0004	DWORD - istnAgg	0xFFFFFFFF
1 bit	DWORD - fAutoFilter	0x1
1 bit	DWORD - fAutoFilterHidden	0x0
1 bit	DWORD - fLoadXmapi	0x0
1 bit	DWORD - fLoadFmla	0x0
2 bits	DWORD - unused1	0x0
1 bit	DWORD - reserved2	0x0
1 bit	DWORD - fLoadTotalFmla	0x0
1 bit	DWORD - fLoadTotalArray	0x0
1 bit	DWORD - fSaveStyleName	0x0
1 bit	DWORD - fLoadTotalStr	0x0
1 bit	DWORD - fAutoCreateCalcCol	0x0
20 bits	DWORD - unused2	0x00000
0004	DWORD - cbFmtInsertRow	0x00000000
0004	DWORD - istnInsertRow	0xFFFFFFFF
0004	XLUnicodeString - strFieldName	1
0007	XLUnicodeString - strCaption	Item
0006	Feat11FdaAutoFilter - AutoFilter	
0004	DWORD - cbAutoFilter	0x00000000
0002	USHORT - unused	0x0001

Size	Structure	Value
0036	Feat11FieldDataItem - Feat11FieldDataItem[1]	
0004	DWORD - idField	0x00000002
0004	DWORD - lfdt	0x00000000
0004	DWORD - lfxidt	0x00000000
0004	DWORD - ilta	0x00000000
0004	DWORD - cbFmtAgg	0x00000000
0004	DWORD - istnAgg	0xFFFFFFFF
1 bit	DWORD - fAutoFilter	0x1
1 bit	DWORD - fAutoFilterHidden	0x0
1 bit	DWORD - fLoadXmapi	0x0
1 bit	DWORD - fLoadFmla	0x0
2 bits	DWORD - unused1	0x0
1 bit	DWORD - fLoadCalcColArray	0x0
1 bit	DWORD - fLoadTotalFmla	0x0
1 bit	DWORD - fLoadTotalArray	0x0
1 bit	DWORD - fSaveStyleName	0x0
1 bit	DWORD - fLoadTotalStr	0x0
1 bit	DWORD - fAutoCreateCalcCol	0x0
20 bits	DWORD - unused2	0x000000
0004	DWORD - cbFmtInsertRow	0x00000000
0004	DWORD - istnInsertRow	0xFFFFFFFF
0004	XLUncodeString - strFieldName	2
0008	XLUncodeString - strCaption	Price
0006	Feat11FdaAutoFilter - AutoFilter	
0004	DWORD - cbAutoFilter	0x00000000
0002	USHORT - unused	0x0002
003A	Feat11FieldDataItem - Feat11FieldDataItem[2]	
0004	DWORD - idField	0x00000003
0004	DWORD - lfdt	0x00000000
0004	DWORD - lfxidt	0x00000000
0004	DWORD - ilta	0x00000000

Size	Structure	Value
0004	DWORD - cbFmtAgg	0x00000000
0004	DWORD - istnAgg	0xFFFFFFFF
1 bit	DWORD - fAutoFilter	0x1
1 bit	DWORD - fAutoFilterHidden	0x0
1 bit	DWORD - fLoadXmapi	0x0
1 bit	DWORD - fLoadFmla	0x0
2 bits	DWORD - unused1	0x0
1 bit	DWORD - fLoadCalcColArray	0x0
1 bit	DWORD - fLoadTotalFmla	0x0
1 bit	DWORD - fLoadTotalArray	0x0
1 bit	DWORD - fSaveStyleName	0x0
1 bit	DWORD - fLoadTotalStr	0x0
1 bit	DWORD - fAutoCreateCalcCol	0x0
20 bits	DWORD - unused2	0x00000
0004	DWORD - cbFmtInsertRow	0x00000000
0004	DWORD - istnInsertRow	0xFFFFFFFF
0004	XLUncodeString - strFieldName	3
000C	XLUncodeString - strCaption	Sales Tax
0006	Feat11FdaAutoFilter - AutoFilter	
0004	DWORD - cbAutoFilter	0x00000000
0002	USHORT - unused	0x0003

Figure 28: Structure of Feature11

frtRefHeaderU: This structure specifies a future version record type header.

frtRefHeaderU.rt: 0x0872 specifies that this record belongs to a record of type Feature11.

frtRefHeaderU.grbitFrt: Specifies attributes for this record.

frtRefHeaderU.grbitFrt.fFrtRef: 0x1 specifies that the containing record specifies a range of **cells**.

frtRefHeaderU.grbitFrt.fFrtAlert: 0x0 specifies not to alert the user of possible problems when saving as an earlier version of the file format.

frtRefHeaderU.ref8: Specifies a range of cells on the sheet. This refers to the range C4:E7. Because frt.rt is equal to 0x0872, this field is ignored.

frtRefHeaderU.ref8.rwFirst: Specifies the first row in the Table range.

frtRefHeaderU.ref8.rwFirst.rw: 0x0003 specifies the first row in the table on the sheet. This refers to row four of the sheet.

frtRefHeaderU.ref8.rwLast: Specifies the last row in the table range.

frtRefHeaderU.ref8.rwLast.rw: 0x0006 specifies the last row in the table on the sheet. This refers to row seven of the sheet.

frtRefHeaderU.ref8.colFirst: Specifies the first column in the table range.

frtRefHeaderU.ref8.colFirst.col: 0x0002 specifies the first column in the table on the sheet. This refers to column C of the sheet.

frtRefHeaderU.ref8.colLast: Specifies the last column in the table range.

frtRefHeaderU.ref8.colLast.col: 0x0004 specifies the last column in the table on the sheet. This refers to column E of the sheet.

isf: 0x0005 specifies that the shared feature type is a table feature.

cref2: 0x0001 specifies the count of Ref8U records within the **refs2** field. **refs2** contains one Ref8U record.

cbFeatData: 0x00000000 specifies that the size of the **rgbFeat** field is calculated using the following formula:

- Size of **rgbFeat** = record total size in bytes – size of **refs2** in bytes – 27 bytes
- Size of **rgbFeat** = 278 bytes - 8 bytes - 27 bytes
- Size of **rgbFeat** = 243 bytes

refs2: Specifies the references to the ranges of cells within the sheet that are affected by the feature.

refs2.ref[0]: The first Ref8U record in the array. It specifies the range C4:E7. This specifies the range of cells for the table.

refs2.ref[0].rwFirst.rw: 0x0003 specifies that the first row of the range is row four.

refs2.ref[0].rwLast.rw: 0x0006 specifies that the last row of the range is row seven.

refs2.ref[0].colFirst.col: 0x0002 specifies that the first column of the range is column C.

refs2.ref[0].colLast.col: 0x0004 specifies that the last column of the range is column E.

rgbFeat: Specifies any of the possible features for this record. Contains a TableFeatureType record, as indicated by isf.

rgbFeat.TableFeature: Specifies the definition of this table.

rgbFeat.TableFeature.It: 0x00000000 specifies the type of **data source** for the table is a range.

rgbFeat.TableFeature.idList: 0x00000001 specifies the identifier for the table.

rgbFeat.TableFeature.crwHeader: 0x00000001 specifies there is a row at the top of the table that is used as a **header row**.

rgbFeat.TableFeature.crwTotals: 0x00000000 specifies there is not a row at the bottom of the table that is used as a **total row**.

rgbFeat.TableFeature.idFieldNext: 0x00000004 specifies the next unique identifier to try when assigning unique identifiers to columns of the table.

rgbFeat.TableFeature.cbFSDData: 0x00000040 specifies the size, in bytes, of the fixed portion of this TableFeatureType structure.

rgbFeat.TableFeature.rupBuild: This value is not valid, as specified by **rgbFeat.TableFeature.fGoodRupBld**.

rgbFeat.TableFeature.fAutoFilter: 0x1 specifies the table has **AutoFilters**.

rgbFeat.TableFeature.fPersistAutoFilter: 0x1 specifies that the AutoFilter information is preserved for this table across data refresh operations.

rgbFeat.TableFeature.fShowInsertRow: 0x0 specifies the **insert row** is not visible.

rgbFeat.TableFeature.fInsertRowInsCells: 0x0 specifies rows are not shifted down because the insert row is not visible.

rgbFeat.TableFeature.fLoadPldwIdDeleted: 0x0 specifies the **idDeleted** field is not present.

rgbFeat.TableFeature.fShownTotalRow: 0x0 specifies the total row is not displayed at the bottom of the table.

rgbFeat.TableFeature.fNeedsCommit: 0x0 specifies that only table modifications that are synchronized with the data source exist.

rgbFeat.TableFeature.fSingleCell: 0x0 specifies the table is not limited to a single cell.

rgbFeat.TableFeature.fApplyAutoFilter: 0x1 specifies that the AutoFilter is currently applied.

rgbFeat.TableFeature.fForceInsertToBeVis: 0x0 specifies the insert row is not forced to be visible.

rgbFeat.TableFeature.fCompressedXml: 0x0 specifies the XML data linked to the table is to be compressed. No XML data link is present.

rgbFeat.TableFeature.fLoadCSPName: 0x0 specifies that the **CSPName** field is not present.

rgbFeat.TableFeature.fLoadPldwIdChanged: 0x0 specifies that the **IdChanged** field is not present.

rgbFeat.TableFeature.verXL: 0xB specifies the table was created using Microsoft Office Excel 2003.

rgbFeat.TableFeature.fLoadEntryId: 0x1 specifies the **EntryId** field is present

rgbFeat.TableFeature.fLoadPllstclInvalid: 0x0 specifies the **CellInvalid** field is not present

rgbFeat.TableFeature.fGoodRupBld: 0x0 specifies the **rupBuild** field is not valid.

rgbFeat.TableFeature.fPublished: 0x0 specifies the table was not published.

rgbFeat.TableFeature.lPosStmCache: 0x00000000 specifies the cached data begins at position 0 in the [List Data stream](#).

rgbFeat.TableFeature.cbStmCache: 0x00000000 specifies the size, in bytes, of the cached data within the List Data stream is 0.

rgbFeat.TableFeature.cchStmCache: 0x00000000 specifies the count of characters of the cached data within the List Data stream when uncompressed is 0.

rgbFeat.TableFeature.lem: 0x00000000 specifies the table can be directly edited inline.

rgbFeat.TableFeature.rgbHashParam: The value of this field is required to be zeros because the **It** field is not equal to 0x00000001.

rgbFeat.TableFeature.rgbName: *List1* specifies the unique name of the table.

rgbFeat.TableFeature.cFieldData: 0x0003 specifies the number of columns in the table.

rgbFeat.TableFeature.entryId: 1 specifies the unique identifier for the table. This is ignored because the **It** field is not equal to 0x00000002.

rgbFeat.TableFeature.fieldData: An array of **Feat11FieldDataItem** that contains the definition of the columns of the table. The array contains three items as specified by the **cFieldData** field.

rgbFeat.TableFeature.fieldData.Feat11FieldDataItem[0]: Specifies the definition of the first column of the table.

rgbFeat.TableFeature.fieldData.Feat11FieldDataItem[0].idField: 0x00000001 specifies the identifier of the column.

rgbFeat.TableFeature.fieldData.Feat11FieldDataItem[0].lfdt: 0x00000000 specifies that the table column is of the Web-based data provider data type. This value specifies that the field is unused.

rgbFeat.TableFeature.fieldData.Feat11FieldDataItem[0].lfxidt: 0x00000000 specifies the table column XML data type. This value specifies the field is unused.

rgbFeat.TableFeature.fieldData.Feat11FieldDataItem[0].ilta: 0x00000000 specifies the aggregation function to use for the column. This value specifies that no formula is used.

rgbFeat.TableFeature.fieldData.Feat11FieldDataItem[0].cbFmtAgg: 0x00000000 specifies that the **dxFmtAgg** field does not exist.

rgbFeat.TableFeature.fieldData.Feat11FieldDataItem[0].istnAgg: 0xFFFFFFFF specifies the total row of the column uses the default style of the table.

rgbFeat.TableFeature.fieldData.Feat11FieldDataItem[0].fAutoFilter: 0x1 specifies that this column has AutoFilters.

rgbFeat.TableFeature.fieldData.Feat11FieldDataItem[0].fAutoFilterHidden: 0x0 specifies that this column has AutoFilters displayed.

rgbFeat.TableFeature.fieldData.Feat11FieldDataItem[0].fLoadXmap: 0x0 specifies the **rgXmap** field is not present.

rgbFeat.TableFeature.fieldData.Feat11FieldDataItem[0].fLoadFmla: 0x0 specifies that the **fmla** field is not present.

rgbFeat.TableFeature.fieldData.Feat11FieldDataItem[0].fLoadTotalFmla: 0x0 specifies that the **totalFmla** field is not present.

rgbFeat.TableFeature.fieldData.Feat11FieldDataItem[0].fLoadTotalArray: 0x0 specifies that the formula specified by **totalFmla** is not an array formula.

rgbFeat.TableFeature.fieldData.Feat11FieldDataItem[0].fSaveStyleName: 0x0 specifies that the **dskHdrCache.strStyleName** field is not present.

rgbFeat.TableFeature.fieldData.Feat11FieldDataItem[0].fLoadTotalStr: 0x0 specifies the **strTotal** field is not present.

rgbFeat.TableFeature.fieldData.Feat11FieldDataItem[0].fAutoCreateCalcCol: 0x0 specifies the column does not have a calculated column formula.

rgbFeat.TableFeature.fieldData.Feat11FieldDataItem[0].cbFmtInsertRow: 0x00000000 specifies that the **dxFmtInsertRow** field does not exist.

rgbFeat.TableFeature.fieldData.Feat11FieldDataItem[0].istnInsertRow: 0xFFFFFFFF specifies the insert row of the column uses the default style of the table.

rgbFeat.TableFeature.fieldData.Feat11FieldDataItem[0].strFieldName: Specifies the name of the column, as provided by the data source.

rgbFeat.TableFeature.fieldData.Feat11FieldDataItem[0].strCaption: *Item* specifies the caption of the column.

rgbFeat.TableFeature.fieldData.Feat11FieldDataItem[0].AutoFilter: Specifies the characteristics of the AutoFilter for the column

rgbFeat.TableFeature.fieldData.Feat11FieldDataItem[0].AutoFilter.cbAutoFilter: 0x00000000 specifies that the **recAutoFilter** field does not exist.

rgbFeat.TableFeature.fieldData.Feat11FieldDataItem[1]: Specifies the definition of the second column of the table. The details of most of the fields within this structure are omitted here because they are the same as the fields in the first column
rgbFeat.TableFeature.fieldData.Feat11FieldDataItem[0].

rgbFeat.TableFeature.fieldData.Feat11FieldDataItem[2]: Specifies the definition of the third column of the table. The details of most of the fields within this structure are omitted here because they are the same as the fields in the first column
rgbFeat.TableFeature.fieldData.Feat11FieldDataItem[0].

3.4 Filters

This example shows how filters are applied to a **range of cells** (C4:C8) on a **sheet** when the **AutoFilter** is set to display items that are greater than 70.

The first record in this example is the [FilterMode](#) record that appears in a [worksheet substream](#) (the worksheet substream is not included in this example for brevity). This record specifies that the data in the containing sheet is filtered.

Other records mentioned in this example are the [AutoFilterInfo](#) record and [AutoFilter](#) record. They specify the properties of the AutoFilter and define the conditions that are used to filter the data.

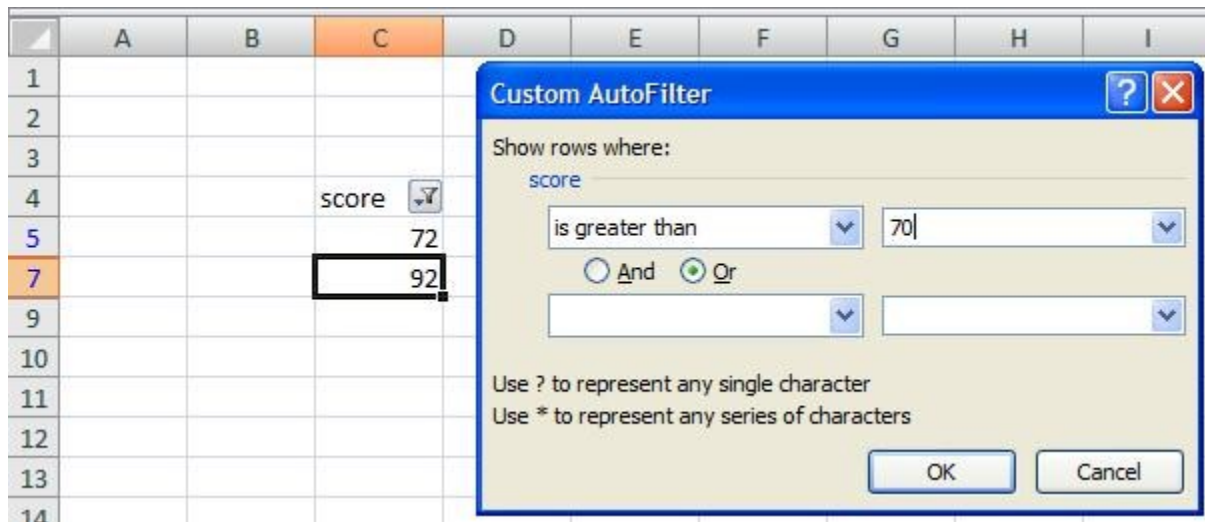

Figure 29: AutoFilter in this example within a sheet

3.4.1 Filters: FilterMode

The first record in this example, [FilterMode](#), specifies that the data in the containing **sheet** is filtered.

Size	Structure
0000	FilterMode - FilterMode

Figure 30: Structure of FilterMode

3.4.2 Filters: AutoFilterInfo

The [AutoFilterInfo](#) record specifies the number of columns that have **AutoFilter** enabled and indicates the beginning of the collection of [AutoFilter](#) records.

Size	Structure	Value
0002	AutoFilterInfo - AutoFilterInfo	
0002	USHORT - cEntries	0x0001

Figure 31: Structure of AutoFilterInfo

cEntries: 0x0001 specifies the number of filtered columns.

3.4.3 Filters: AutoFilter

Next, the [AutoFilter](#) record specifies the criteria that are used to filter the data.

Size	Structure	Value
0018	AutoFilter - AutoFilter	
0002	USHORT - iEntry	0x0000
2 bits	USHORT - wJoin	0x0
1 bit	USHORT - fSimple1	0x0
1 bit	USHORT - fSimple2	0x0
1 bit	USHORT - fTopN	0x0
1 bit	USHORT - fTop	0x0
1 bit	USHORT - fPercent	0x0
9 bits	USHORT - wTopN	0x000
000A	AFDOper - doper1	
0001	BYTE - vt	0x02
0001	BYTE - grbitSign	0x04
0008	AFDOperRk - vtValue	
0004	RkNumber - rk	
1 bit	ULONG - fX100	0x0
1 bit	ULONG - fInt	0x0
30 bits	ULONG - num	0x10146000
0004	DWORD - unused1	0x00000000

Size	Structure	Value
000A	AFDOper - doper2	
0001	BYTE - vt	0x00
0001	BYTE - grbitSign	0x00
0008	BLOB - vtValue	0x0000000000000000

Figure 32: Structure of AutoFilter

iEntry: 0x0000 specifies that this **AutoFilter** applies to the first column in this **sheet**.

wJoin: 0x0 specifies that filtering conditions specified in **doper1** and **doper2** conditions are joined by a logical AND operation when applying the AutoFilter.

fSimple1: 0x0 specifies that an application-specific performance optimization cannot be used.

fSimple2: 0x0 specifies that an application-specific performance optimization cannot be used.

fTopN: 0x0 specifies that this AutoFilter is not a **Top N filter**.

fTop: 0x0 is ignored because **fTopN** is 0.

fPercent: 0x0 is ignored because **fTopN** is 0.

wTopN: 0x000 is ignored because **fTopN** is 0.

doper1: An AFDOper that specifies the first AutoFilter condition.

doper1.vt: 0x02 specifies that the type of comparison is numeric.

doper1.grbitSign: 0x04 specifies that the comparison operation is GREATER THAN.

doper1.vtValue: An AFDOperRk that specifies a numeric value.

doper1.vtValue.rk: An RkNumber specifies a numeric value.

doper1.vtValue.rk.fx100: 0x0 specifies that the value in the **doper1.vtValue.rk.num** field was not multiplied by 100 when it was saved.

doper1.vtValue.rk.fInt: 0x0 specifies that the value in the **doper1.vtValue.rk.num** field is 30 most significant bits of a 64-bit binary floating-point number.

doper1.vtValue.rk.num: 0x10146000 specifies the 30 most significant bits of a 64-bit binary floating-point number whose remaining bits are 0. That number is 70.

doper2: An AFDOper that specifies the second AutoFilter condition.

doper2.vt: 0x00 specifies that there is no second AutoFilter defined.

doper2.grbitSign: 0x00 specifies that there is no second filter.

doper2.vtValue: 0x0000000000000000 is ignored because **doper2.vt** is 0.

3.5 External References

This example shows a workbook where the cell F5 contains an external reference to [Book1.xls]Sheet1!B3. The example workbook and Book1.xls are in the same folder, and the **cell** contents of Sheet1!B3 in the external workbook contains the string "External Cell". The following figure shows a possible implementation of the external reference discussed in this example:

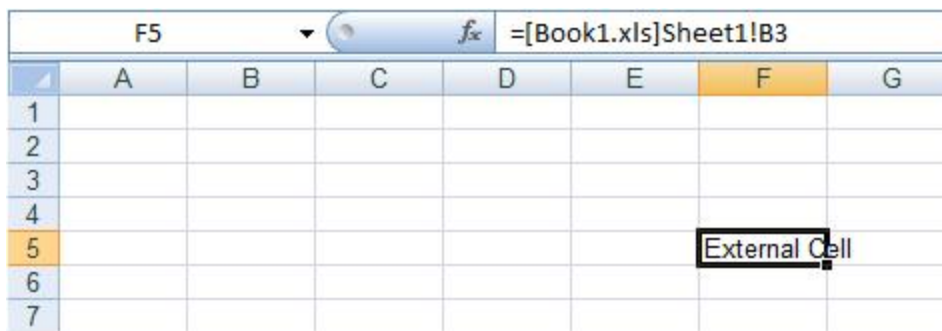

Figure 33: External reference in this example a sheet

3.5.1 External References: Formula

The first record in this example is the [Formula](#) record that appears in the [global substream](#) (the global substream is not included in this example for brevity). This record specifies the formula for the cell F5. The formula is a reference to a [cell](#) in an external [worksheet](#).

Other records mentioned in this example are [String](#), [SupBook](#), [XCT](#), [CRN](#) and [ExternSheet](#) records. These records specify the external referenced cell as well as the [external cell cache](#) that stores the cached value of the cell.

Size	Structure	Value
001D	Formula - Formula	
0006	Cell - cell	
0002	Rw - rw	
0002	USHORT - rw	0x0004
0002	Col - col	
0002	USHORT - col	0x0005
0002	IXFCell - ixfe	
0002	USHORT - ixfe	0x000F
0008	FormulaValue - val	
0001	BYTE - byte1	0x00
0001	BYTE - byte2	0x00
0001	BYTE - byte3	0xA0
0001	BYTE - byte4	0x00
0001	BYTE - byte5	0x9C
0001	BYTE - byte6	0x01
0002	USHORT - fExprO	0xFFFF
1 bit	USHORT - fAlwaysCalc	0x0
1 bit	USHORT - reserved1	0x0

Size	Structure	Value
1 bit	USHORT - fFill	0x0
1 bit	USHORT - fShrFmla	0x0
1 bit	USHORT - reserved2	0x0
1 bit	USHORT - fClearErrors	0x0
10 bits	USHORT - reserved3	0x000
0004	ULONG - unused	0xFCC412C8
0009	CellParsedFormula - formula	
0002	WORD - cce	0x0007
0007	Rgce - rgce	
0007	Ptg - Ptg[0]	
0007	PtgRef3d - PtgRef3d	
5 bits	BYTE - ptg	0x1A
2 bits	PtgDataType - type	0x2
1 bit	BYTE - reserved	0x0
0002	USHORT - ixti	0x0000
0004	RgceLoc - loc	
0002	RwU - row	
0002	USHORT - rw	0x0002
0002	ColRelU - column	
14 bits	USHORT - col	0x0001
1 bit	USHORT - colRelative	0x1
1 bit	USHORT - rowRelative	0x1

Figure 34: Structure of Formula

cell: Specifies a cell in this **sheet** that contains the external reference. The specified cell is F5.

cell.rw: Specifies the row of this cell in this sheet.

cell.rw.rw: 0x0004 specifies that the row of this cell is row 5.

cell.col: Specifies the column of this cell in this sheet.

cell.col.col: 0x0005 specifies that the column of this cell is column F.

cell.ixfe: Specifies the formatting properties for this cell.

cell.ixfe.ixfe: 0x000F specifies that the cell has the default cell format.

val: Specifies the value to which the formula evaluated. This specifies the value stored in cell F5.

val.byte1: 0x00 specifies that the value to which this formula is evaluated is a string value. The string value is stored in the String record following this record.

val.fExprO: 0xFFFF specifies that the value to which this formula evaluated is a Boolean value, an error value, a string value, or a blank string value and that **val.byte2**, **val.byte3**, **val.byte4**, **val.byte5**, and **val.byte6** are ignored. **val.byte2**, **val.byte3**, **val.byte4**, **val.byte5**, and **val.byte6** are omitted from this example for brevity.

fAlwaysCalc: 0x0 specifies that this cell value is not to be calculated during the next recalculation.

fFill: 0x0 specifies that this cell has either a **fill alignment** or a **center-across-selection alignment**.

fShrFmla: 0x0 specifies that the formula (section [2.2.2](#)) is not part of a shared formula.

fClearErrors: 0x0 specifies that the formula is not excluded from **formula error checking**.

formula: Specifies the formula contained in the cell F5 in this sheet.

formula.cce: 0x0007 specifies that the following **formula.rgce** field is 7 bytes.

formula.rgce: Specifies the sequence of Ptgs structures. The sequence of Ptgs specify the formula.

formula.rgce.Ptg[0]: The first and only Ptgs structure in the sequence. Specifies that there is only one element in the formula.

formula.rgce.Ptg[0].PtgRef3d: Specifies the PtgRef3d structure. Specifies that the formula is a reference to a single cell in a sheet.

formula.rgce.Ptg[0].PtgRef3d.ptg: 0x1A specifies that this Ptgs is a PtgRef3d structure.

formula.rgce.Ptg[0].PtgRef3d.type: 0x2 specifies that the PtgRef3d data type is a single value.

formula.rgce.Ptg[0].PtgRef3d.ixti: 0x0000 specifies the first [XTI](#) structure of the **rgXTI** array in the ExternSheet record. The first XTI of the **rgXTI** array specifies the Supbook record that specifies the target sheet that contains the referenced cell. This Supbook record is the third record in this example. The ExternSheet record is the seventh record in this example.

formula.rgce.Ptg[0].PtgRef3d.loc: Specifies the coordinates of the referenced cell. This field is a Rgceloc value because PtgRef3d is not part of a [NameParsedFormula](#) structure.

formula.rgce.Ptg[0].PtgRef3d.loc.row: Specifies the row of the referenced cell.

formula.rgce.Ptg[0].PtgRef3d.loc.row.rw: 0x0002 specifies that the row of the referenced cell is row 3.

formula.rgce.Ptg[0].PtgRef3d.loc.column: Specifies the column of the referenced cell.

formula.rgce.Ptg[0].PtgRef3d.loc.column.col: 0x0001 specifies that the column of the referenced cell is column B.

formula.rgce.Ptg[0].PtgRef3d.loc.column.colRelative: 0x1 specifies that the column is a **relative reference**.

formula.rgce.Ptg[0].PtgRef3d.loc.column.rowRelative: 0x1 specifies that the row is a relative reference.

3.5.2 External References: String

The next record in this example, [String](#), specifies the Unicode string value to which the formula evaluated.

Size	Structure	Value
0010	String - String	
0010	XLUnicodeString - string	External Cell

Figure 35: Structure of String

string: *External Cell* is the Unicode string value.

3.5.3 External References: SupBook 1

The next record in this example, [Supbook](#), specifies an external workbook referencing [supporting link](#) and specifies the beginning of a collection of records that specifies the referenced cell (B3) in the [External Workbook](#) (*Book1.xls*). This record is the first SupBook record in the [global substream](#).

The **workbook** of the referenced cell (*Book1.xls*) is specified in the Supbook record. The **sheet** of the referenced cell (*Sheet1*) is specified in the [XCT](#) record following this record. The referenced cell (B3) is specified in the [CRN](#) record following the XCT record.

Size	Structure	Value
002A	SupBook - SupBook	
0002	USHORT - ctab	0x0003
0002	USHORT - cch	0x000A
000B	XLUnicodeStringNoCch - virtPath	Book1.xls
001B	XLUnicodeString - rgst	
0009	XLUnicodeString - rgst[0]	Sheet1
0009	XLUnicodeString - rgst[1]	Sheet2
0009	XLUnicodeString - rgst[2]	Sheet3

Figure 36: Structure of SupBook

ctab: 0x0003 specifies that there are three sheets in the referenced workbook.

cch: 0x000A specifies that there are 10 characters in **virtPath**.

virtPath: *Book1.xls* specifies the encoded path of the referenced workbook. The length of the string is 10 characters, but the first character is an unprintable Unicode character with a value of 0x01.

rgst: Specifies an array of three sheets contained within the referenced workbook.

rgst.rgst[0]: *Sheet1* specifies the name of the first sheet in the referenced workbook.

rgst.rgst[1]: *Sheet2* specifies the name of the second sheet in the referenced workbook.

rgst.rgst[2]: *Sheet3* specifies the name of the third sheet in the referenced workbook.

3.5.4 External References: XCT

The next record in this example, [XCT](#), specifies the beginning of an [external cell cache](#) and specifies the beginning of a collection of [CRN](#) records. The collection of CRN records specifies the value of the **cell** (B3) in a **sheet** (*Sheet1*) in the external cell cache.

Size	Structure	Value
0004	XCT - Xct	
0002	SHORT - ccrn	0x0001
0002	USHORT - itab	0x0000

Figure 37: Structure of Xct

ccrn: 0x0001 specifies that there is one CRN record immediately following this record.

itab: 0x0000 specifies the first element in the **rgst** field of the [SupBook](#) that specifies that the referenced cell is in the *Sheet1* sheet.

3.5.5 External References: CRN

The next record in this example, [CRN](#), specifies the value of the referenced **cell** in the [external cell cache](#).

Size	Structure	Value
0015	CRN - Crn	
0001	ColByteU - colLast	
0001	BYTE - col	0x01
0001	ColByteU - colFirst	
0001	BYTE - col	0x01
0002	RwU - row	
0002	USHORT - rw	0x0002
0011	CRNOper - crnOper	
0011	SerAr - crnOper[0]	
0001	BYTE - reserved	0x02
0010	SerStr - string	External Cell

Figure 38: Structure of Crn

colLast: Specifies the column of the last cell that has a value in the external cell cache.

colLast.col: 0x01 specifies that the column of the last cell is column B.

colFirst: Specifies the column of the first cell that has a value in the external cell cache.

colFirst.col: 0x01 specifies that the column of the first cell is column B.

row: Specifies the row index of the cell that has a value in the external cell cache.

row.row: 0x0002 specifies that the row of the cell is row 3.

crnOper: Specifies an array of cell values in the range specified by **colLast**, **colFirst** and **row**, which is B3.

crnOper.crnOper[0].string: *External Cell* specifies the text referenced in cell B3.

3.5.6 External References: SupBook 2

The next record in this example, [SupBook](#), specifies a self-referencing [supporting link](#). The self-referencing supporting link is used when a cell in this **workbook** refers to a cell in a different **sheet** in the same workbook. In this example this record is not used. This is the second SupBook record in the [global substream](#).

Size	Structure	Value
0004	SupBook - SupBook	
0002	USHORT - ctab	0x0003
0002	USHORT - cch	0x0401

Figure 39: Structure of SupBook

The **VirtPath** field and **rgst** field of this record are similar to the corresponding fields of the third record (SupBook) in this example and are omitted for brevity.

ctab: 0x0003 specifies that there are three sheets in the referenced workbook.

cch: 0x0401 specifies that this is self-referencing supporting link.

3.5.7 External References: ExternSheet

The next record in this example, [ExternSheet](#), specifies a collection of [XTI](#) records that specify the [supporting link](#) information.

Size	Structure	Value
000E	ExternSheet - ExtSheet	
0002	USHORT - cXTI	0x0002
000C	XTI - rgXTI	
0006	XTI - xti[0]	
0002	USHORT - iSupBook	0x0000
0002	SHORT - itabFirst	0x0000
0002	SHORT - itabLast	0x0000
0006	XTI - xti[1]	
0002	USHORT - iSupBook	0x0001
0002	SHORT - itabFirst	0x0000
0002	SHORT - itabLast	0x0000

Figure 40: Structure of ExtSheet

cXTI: 0x0002 specifies that there are two elements in the **rgXTI** array.

rgXTI: An array of XTI elements. The number of elements in the array is specified by the **cXTI** field.

rgXTI.xti[0]: This is the first XTI element in the array.

rgXTI.xti[0].iSupBook: 0x0000 specifies the reference to the first [SupBook](#) record in the [global substream](#).

rgXTI.xti[0].itabFirst: 0x0000 specifies that the supporting link has a sheet-level scope and specifies the first sheet, within the referenced **workbook**, that is in scope. The first sheet in scope is *Sheet1*.

rgXTI.xti[0].itabLast: 0x0000 specifies that the supporting link has a sheet-level scope and specifies the last sheet, within the referenced workbook, that is in scope. The last sheet in scope is *Sheet1*.

rgXTI.xti[1]: This is the second XTI element in the array. (The details of the referenced XTI record are omitted for brevity.)

rgXTI.xti[1].iSupBook: 0x0001 specifies the reference to the second SupBook record in the global substream.

3.6 Column Chart Object

This example shows a column chart object on a **sheet**. The set of records that specify the column chart exist in the [chart sheet substream](#) of the file (the chart sheet substream is not included in this example for brevity). The column chart specified in this example has a single series with three control points. The following figure shows a possible implementation of the column chart discussed in this example:

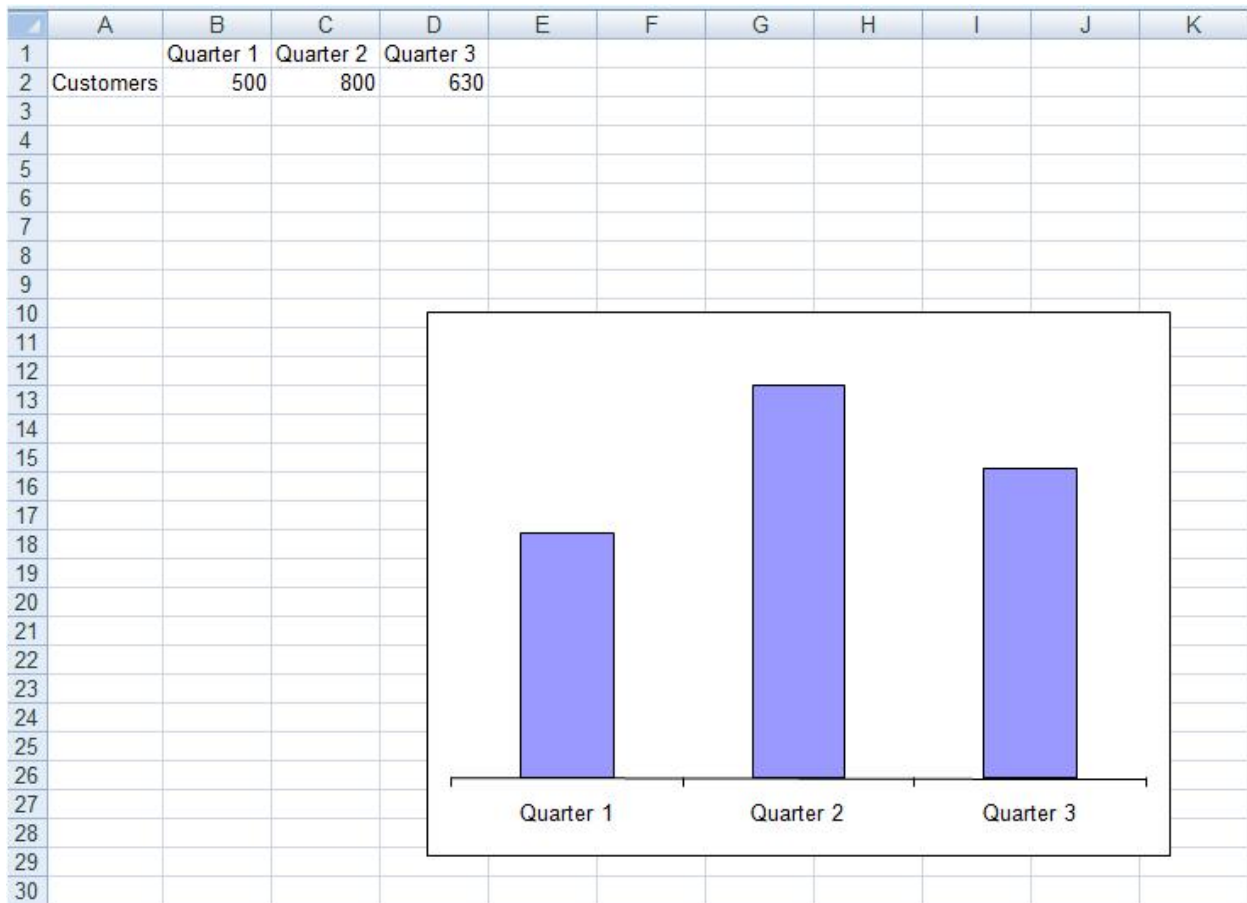

Figure 41: Column chart in this example within a sheet

3.6.1 Column Chart Object: Chart

The first record in this example is the [Chart](#) record. This record specifies the position and dimensions of the **chart area** (section 2.2.3.17). The position of the chart area is automatically calculated by the application and the dimension of the chart is specified by the **dx** and **dy** fields.

Size	Structure	Value
0010	Chart - Chart	
0004	FixedPoint - x	0x00000000
0004	FixedPoint - y	0x00000000
0004	FixedPoint - dx	0x01493FD0
0004	FixedPoint - dy	0x00F0C000

Figure 42: Structure of Chart

x: The value of this field is ignored because the **fAutoPosition** field of the **Frame** record that follows this record equals 1.

y: The value of this field is ignored because the **fAutoPosition** field of the **Frame** record that follows this record equals 1.

dx: 0x01493FD0 specifies the width of the chart in **points**. This field is a fixed point and the width is calculated using the following formula:

$$\text{width of chart} = 0149 + (3FD0 / 65536.0) = 329 + (16336 / 65536)$$

dy: 0x00F0C000 specifies the height of the chart in points. This field is a fixed point and the height is calculated using the following formula:

$$\text{height of chart} = 00F0 + (C000 / 65536.0) = 240 + (49152 / 65536)$$

The next record in this example, [Begin](#), specifies the beginning of a collection of records that specifies the chart area (section 2.2.3.17) of the [chart](#).

The next record in this example, [Scl](#), specifies the **zoom level** of the current view in the window used to display the **sheet**. The zoom level of the current view is equal to 1.

The next record in this example, [PlotGrowth](#), specifies the scale factors for **font scaling** in the **plot area**.

(The details of the Begin record, the Scl record, and the PlotGrowth record are omitted from the example for brevity.)

3.6.2 Column Chart Object: Frame

The next record in this example, [Frame](#), specifies the type, size, and position of the frame around the column chart. The size of the frame is stored in the [Chart](#) record and the position of the frame is automatically calculated by the application.

Size	Structure	Value
0004	Frame - Frame	
0002	USHORT - frt	0x0000
1 bit	USHORT - fAutoSize	0x0

Size	Structure	Value
1 bit	USHORT - fAutoPosition	0x1
14 bits	USHORT - reserved	0x0000

Figure 43: Structure of Frame

frt: 0x0000 specifies that the frame surrounding the chart element does not have a shadow.

fAutoSize: 0x0000 specifies that the size of the frame is not automatically calculated. The width (**dx** field) and height (**dy** field) of the Chart record are used as the size of the frame.

fAutoPosition: 0x0001 specifies that the position of the frame is automatically calculated by the application and the **x** and **y** fields of the Chart record are ignored.

3.6.3 Column Chart Object: LineFormat

The next record in this example, [LineFormat](#), specifies the appearance of the lines of the frame.

Size	Structure	Value
000C	LineFormat - LineFormat	
0004	LongRGB - rgb	
0001	BYTE - red	0x00
0001	BYTE - green	0x00
0001	BYTE - blue	0x00
0001	BYTE - reserved	0x00
0002	USHORT - Ins	0x0000
0002	SHORT - we	0x0000
1 bit	USHORT - fAuto	0x1
1 bit	USHORT - reserved1	0x0
1 bit	USHORT - fAxisOn	0x0
1 bit	USHORT - fAutoCo	0x1
12 bits	USHORT - reserved2	0x000
0002	IcvChart - icv	
0002	USHORT - icv	0x004D

Figure 44: Structure of LineFormat

(Fields in this record that are ignored because **fAuto** is 0x1 are omitted for brevity.)

fAuto: 0x1 specifies that the contents of the **Ins**, **we**, **icv**, and **rgb** field are ignored and the defaults specified in the following table are used instead:

Attribute	Default Value
Line pattern (Ins)	0xFFFF (Hairline)
Line weight (we)	0x0000 (Narrow)

Attribute	Default Value
Line color (icv)	0x004D
Line color (rgb)	0x004D

fAxisOn: 0x0000 specifies this field is ignored because the previous record is not an [AxisLine](#) record with an **id** field equal to 0X0000, specifying the frame does not have any [axis](#) lines.

3.6.4 Column Chart Object: AreaFormat

The next record in this example, [AreaFormat](#), specifies the patterns and colors used in the filled area of the column chart.

Size	Structure	Value
0010	AreaFormat - AreaFormat	
0004	LongRGB - rgbFore	
0001	BYTE - red	0xFF
0001	BYTE - green	0xFF
0001	BYTE - blue	0xFF
0001	BYTE - reserved	0x00
0004	LongRGB - rgbBack	
0001	BYTE - red	0x00
0001	BYTE - green	0x00
0001	BYTE - blue	0x00
0001	BYTE - reserved	0x00
0002	SHORT - fls	0x0001
1 bit	WORD - fAuto	0x1
1 bit	WORD - fInvertNeg	0x0
14 bits	WORD - reserved	0x0000
0002	IcvChart - icvFore	
0002	USHORT - icv	0x004E
0002	IcvChart - icvBack	
0002	USHORT - icv	0x004D

Figure 45: Structure of AreaFormat

(Fields in this record that are ignored because **fAuto** is 0x1 are omitted for brevity.)

fls: 0x0001 specifies that the fill pattern is solid.

fAuto: 0x1 specifies that the fill colors are automatically set by the application.

The next record in this example, [End](#), specifies the end of a collection of records that specifies the **chart area** (section [2.2.3.17](#)) of the [chart](#). The details of End record are omitted from the example for brevity.

3.6.5 Column Chart Object: Series

The next record in this example, [Series](#), specifies a Series of this chart, the type of data it contains and the number of data fields that make up this series. The series of this column chart contains three textual **categories (2)** and three numerical values. In this example the series of this column chart is specified by the first Series record in the collection of Series records in the current [chart sheet substream](#).

Size	Structure	Value
000C	Series - Series	
0002	USHORT - sdtX	0x0003
0002	USHORT - sdtY	0x0001
0002	USHORT - cValx	0x0003
0002	USHORT - cValy	0x0003
0002	USHORT - sdtBSize	0x0001
0002	USHORT - cValBSize	0x0000

Figure 46: Structure of Series

Fields in this record that are ignored because this [chart group](#) is not of the type bubble chart group, are omitted for brevity.

sdtX: 0x0003 specifies that the categories (2) contain text information.

sdtY: 0x0001 specifies that the values contain numeric information.

cValx: 0x0003 specifies that the count of categories (2) is 3.

cValy: 0x0003 specifies that the count of values is 3.

Records following this record, and before the next [BRAI](#) record, are omitted for brevity.

3.6.6 Column Chart Object: BRAI 1

The next record in this example, [BRAI](#), specifies a reference to **cells** in a **sheet** that have values that specify the name of the series.

Size	Structure	Value
000F	BRAI - BRAI	
0001	BYTE - id	0x00
0001	BYTE - rt	0x02
1 bit	USHORT - fUnlinkedIfmt	0x0
15 bits	USHORT - reserved	0x0000
0002	IFmt - ifmt	0x0000

Size	Structure	Value
0009	ChartParsedFormula - formula	
0002	WORD - cce	0x0007
0007	Rgce - rgce	
0007	Ptg - Ptg[0]	
0007	PtgRef3d - PtgRef3d	
5 bits	BYTE - ptg	0x1A
2 bits	PtgDataType - type	0x1
1 bit	BYTE - reserved	0x0
0002	USHORT - ixti	0x0000
0004	RgceLoc - loc	
0002	RwU - row	
0002	USHORT - rw	0x0001
0002	ColRelU - column	
14 bits	USHORT - col	0x0000
1 bit	USHORT - colRelative	0x0
1 bit	USHORT - rowRelative	0x0

Figure 47: Structure of BRAI

id: 0x00 specifies that the values of the referenced cells specify the name of the series.

rt: 0x02 specifies that the **data source** is values from a range of cells in a sheet specified by the **rgce** field.

fUnlinkedIfmt: 0x0 specifies that the series name maintains the number formatting of the referenced data.

ifmt: 0x0000 specifies that the **number format** for the name of the series is automatically determined by the application.

formula.cce: 0x0007 specifies that the length of **rgce** is 7 bytes.

formula.rgce.Ptg[0].PtgRef3d: This operand specifies a reference to a specific cell on one or more sheets.

formula.rgce.Ptg[0].PtgRef3d.ptg: 0x1A specifies that this Ptg is of type PtgRef3d.

formula.rgce.Ptg[0].PtgRef3d.type: 0x1 specifies that the value of the **ptg** field is a reference to a **range**.

formula.rgce.Ptg[0].PtgRef3d.ixti: 0x0000 specifies that the name of the series is found on the sheets referenced by the first **XTI** in the **ExternSheet** record.

formula.rgce.Ptg[0].PtgRef3d.loc: Specifies that the coordinates of the referenced cell for the name of the series refers to cell A2.

formula.rgce.Ptg[0].PtgRef3d.loc.row.rw: 0x0001 specifies that the referenced cell is in row two.

formula.rgce.Ptg[0].PtgRef3d.loc.column.col: 0x0000 specifies that the referenced cell is in column A.

formula.rgce.Ptg[0].PtgRef3d.loc.column.colRelative: 0x0 specifies that the **col** field is an **absolute reference**.

formula.rgce.Ptg[0].PtgRef3d.loc.column.rowRelative: 0x0 specifies that the **rw** field is an absolute reference.

3.6.7 Column Chart Object: SeriesText

The next record in this example, [SeriesText](#), specifies the name of this [Series](#). The name of this Series is *Customers*.

Size	Structure	Value
0016	SeriesText - SeriesText	
0002	USHORT - reserved	0x0000
0014	ShortXLUnicodeString - stText	Customers

Figure 48: Structure of SeriesText

stText: *Customers* specifies name of the series.

3.6.8 Column Chart Object: BRAI 2

The next record in this example, [BRAI](#), specifies a reference to data in a **sheet** that specifies the values of this series. The values for this series are stored in the range B2:D2.

Size	Structure	Value
0013	BRAI - BRAI	
0001	BYTE - id	0x01
0001	BYTE - rt	0x02
1 bit	USHORT - fUnlinkedIfmt	0x0
15 bits	USHORT - reserved	0x0000
0002	IFmt - ifmt	0x0000
000D	ChartParsedFormula - formula	
0002	WORD - cce	0x000B
000B	Rgce - rgce	
000B	Ptg - Ptg[0]	
000B	PtgArea3d - PtgArea3d	
5 bits	BYTE - ptg	0x1B
2 bits	PtgDataType - type	0x1

Size	Structure	Value
1 bit	BYTE - reserved	0x0
0002	USHORT - ixti	0x0000
0008	RgceArea - area	
0002	RwU - rowFirst	
0002	USHORT - rw	0x0001
0002	RwU - rowLast	
0002	USHORT - rw	0x0001
0002	ColRelU - columnFirst	
14 bits	USHORT - col	0x0001
1 bit	USHORT - colRelative	0x0
1 bit	USHORT - rowRelative	0x0
0002	ColRelU - columnLast	
14 bits	USHORT - col	0x0003
1 bit	USHORT - colRelative	0x0
1 bit	USHORT - rowRelative	0x0

Figure 49: Structure of BRAI

id: 0x01 specifies that the referenced data specifies the values of the series.

rt: 0x02 specifies that the **data source** is values from a range of cells in a sheet specified by the **rgce** field.

fUnlinkedIfmt: 0x0 specifies that the series maintains the number formatting of the referenced data.

ifmt: 0x0000 specifies that the **number format** for the values of the series is automatically determined by the application.

formula.cce: 0x000B specifies that the length of the **rgce** field is 11 bytes.

formula.rgce.Ptg[0].PtgArea3d: This operand specifies a reference to the rectangular range of cells on the sheet.

formula.rgce.Ptg[0].PtgArea3d.ptg: 0x1B specifies that this Ptg structure is of type PtgArea3d.

formula.rgce.Ptg[0].PtgArea3d.type: 0x01 specifies that the value of the **ptg** field is a reference to a range.

formula.rgce.Ptg[0].PtgArea3d.ixti: 0x0000 specifies the values of the series are found on the sheet referenced by the first **XTI** structure in the [ExternSheet](#) record.

formula.rgce.Ptg[0].PtgArea3d.area: Specifies that the coordinates of the referenced rectangular range of cells for values of the series are in the range B2:D2.

formula.rgce.Ptg[0].PtgArea3d.area.rowFirst.rw: 0x0001 specifies that row two of the sheet is the first row of the rectangular range of cells.

formula.rgce.Ptg[0].PtgArea3d.area.rowLast.rw: 0x0001 specifies that row two of the sheet is the last row of the rectangular range of cells.

formula.rgce.Ptg[0].PtgArea3d.area.columnFirst.col: 0x0001 specifies that column B of the sheet is the first column of the rectangular range of cells. The details of this ColRelU are not included in this example for brevity.

formula.rgce.Ptg[0].PtgArea3d.area.columnLast.col: 0x0003 specifies that column D of the sheet is the last column of the rectangular range of cells. The details of this ColRelU are not included in this example for brevity.

3.6.9 Column Chart Object: BRAI 3

The next record in this example, [BRAI](#), specifies a reference to data in a **sheet** that specifies the **category (2)** names of this series. The category (2) names are stored in the range B1:D1.

Size	Structure	Value
0013	BRAI - BRAI	
0001	BYTE - id	0x02
0001	BYTE - rt	0x02
0002	USHORT - fUnlinkedIfmt	0x0000
0002	USHORT - reserved	0x0000
0002	IFmt - ifmt	0x0000
000D	ChartParsedFormula - formula	
0002	WORD - cce	0x000B
000B	Rgce - rgce	
000B	Ptg - Ptg[0]	
000B	PtgArea3d - PtgArea3d	
0001	BYTE - ptg	0x1B
0001	PtgDataType - type	0x01
0001	BYTE - reserved	0x00
0002	USHORT - ixti	0x0000
0008	RgceArea - area	
0002	RwU - rowFirst	
0002	USHORT - rw	0x0000
0002	RwU - rowLast	
0002	USHORT - rw	0x0000
0002	ColRelU - columnFirst	
14 bits	USHORT - col	0x0001

Size	Structure	Value
1 bit	USHORT - colRelative	0x0
1 bit	USHORT - rowRelative	0x0
0002	ColRelU - columnLast	
14 bits	USHORT - col	0x0003
1 bit	USHORT - colRelative	0x0
1 bit	USHORT - rowRelative	0x0

Figure 50: Structure of BRAI

id: 0x02 specifies that the referenced data specifies the category (2) name of the series.

rt: 0x02 specifies that the **data source** is values from a range of cells in a sheet specified by the **rgce** field.

fUnlinkedIfmt: 0x0000 specifies that the series maintains the number formatting of the referenced data.

ifmt: 0x0000 specifies that the **number format** for the category (2) names of the series is automatically determined by the application.

formula.cce: 0x000B specifies that the length of the **rgce** field is 11 bytes.

formula.rgce.Ptg[0].PtgArea3d: This operand specifies a reference to the rectangular range of cells on the sheet.

formula.rgce.Ptg[0].PtgArea3d.ptg: 0x1B specifies that this Ptg structure is of type PtgArea3d.

formula.rgce.Ptg[0].PtgArea3d.type: 0x01 specifies that the data type for the value of the **ptg** field is a reference to a range.

formula.rgce.Ptg[0].PtgArea3d.ixti: 0x0000 specifies that the name of the category (2) is found on the sheet referenced by the first [XTI](#) structure in the [ExternSheet](#) record.

formula.rgce.Ptg[0].PtgArea3d.area: Specifies that the coordinates of the referenced rectangular range of cells for the names of categories (2) are in the range B1:D1.

formula.rgce.Ptg[0].PtgArea3d.area.rowFirst.rw: 0x0000 specifies that the first row of the sheet is the first row of the rectangular range of cells.

formula.rgce.Ptg[0].PtgArea3d.area.rowLast.rw: 0x0000 specifies that the first row of the sheet is the last row of the rectangular range of cells.

formula.rgce.Ptg[0].PtgArea3d.area.columnFirst.col: 0x0001 specifies that the second column of the sheet is the first column of the rectangular range of cells. The details of this ColRelU structure are not included in this example for brevity.

formula.rgce.Ptg[0].PtgArea3d.area.columnLast.col: 0x0003 specifies that the fourth column of the sheet is the last column of the rectangular range of cells. The details of this ColRelU are not included in this example for brevity.

(Records following this record, and before the next [DataFormat](#) record, are omitted for brevity.)

3.6.10 Column Chart Object: DataFormat

The next record in this example, [DataFormat](#), specifies the series of this chart to which the formatting information applies. The formatting information is specified by the [LineFormat](#) record and [AreaFormat](#) record following this record. (The LineFormat and AreaFormat records are not included in this example for brevity.)

Size	Structure	Value
0008	DataFormat - DataFormat	
0002	USHORT - xi	0xFFFF
0002	USHORT - yi	0x0000
0002	SHORT - iss	0x0000
15 bits	SHORT - reserved	0x0000

Figure 51: Structure of DataFormat

xi: 0xFFFF specifies that the LineFormat record and AreaFormat record following this record specify the format of the series.

yi: 0x0000 specifies that the series of this chart is specified by the first [Series](#) record in the collection of Series records in the current [chart sheet substream](#).

iss: 0x0000 specifies the number of the series based on the ordering in the legend, which is zero.

The next two records in this example, LineFormat and AreaFormat, specify the formatting information for the series. (The LineFormat record and AreaFormat record are similar to the LineFormat record and AreaFormat record defined earlier in the example and are omitted for brevity.)

3.6.11 Column Chart Object: SerToCrt

The next record in this example, [SerToCrt](#), specifies the chart that contains the series specified in this example. The [ChartFormat](#) record that specifies this chart is the first ChartFormat record in the [chart sheet substream](#).

Size	Structure	Value
0002	SerToCrt - SerToCrt	
0002	USHORT - id	0x0000

Figure 52: Structure of SerToCrt

id: 0x0000 specifies that the chart that contains the series in this example is specified by the first ChartFormat record in the collection of ChartFormat records in the current chart sheet substream.

(Records following this record, and before the next [ShtProps](#) record, are omitted for brevity.)

3.6.12 Column Chart Object: ShtProps

The next record in this example, [ShtProps](#), specifies the properties of this chart.

Size	Structure	Value
0004	ShtProps - ShtProps	

Size	Structure	Value
1 bit	USHORT - fManSerAlloc	0x0
1 bit	USHORT - fPlotVisOnly	0x1
1 bit	USHORT - fNotSizeWith	0x0
1 bit	USHORT - fManPlotArea	0x1
1 bit	USHORT - fAlwaysAutoPlotArea	0x0
11 bits	USHORT - reserved1	0x000
0001	BYTE - mdBlank	0x00
0001	BYTE - reserved2	0x00

Figure 53: Structure of ShtProps

fManSerAlloc: 0x0 specifies that the series is not automatically allocated for this chart.

fPlotVisOnly: 0x1 specifies to plot only **visible** cells on this chart.

fNotSizeWith: 0x0 specifies not to size this chart with the window.

fAlwaysAutoPlotArea: 0x0 specifies that the default **plot area** dimension is used for this chart.

mdBlank: 0x00 specifies that empty cells are not plotted on this chart.

3.6.13 Column Chart Object: DefaultText

The next record in this example, [DefaultText](#), specifies the text elements that are formatted using the information specified in the [Text](#) record that follows this record.

Size	Structure	Value
0002	DefaultText - DefaultText	
0002	USHORT - id	0x0002

Figure 54: Structure of DefaultText

id: 0x0002 specifies that the default formatting of all text in the chart that does not use scalable fonts is to be set by the Text record following this record.

3.6.14 Column Chart Object: Text

The next record in this example, [Text](#), specifies the position and appearance of text fields specified in the preceding [DefaultText](#) record.

Size	Structure	Value
0020	Text - Text	
0001	BYTE - at	0x02
0001	BYTE - vat	0x02
0002	WORD - wBkgMode	0x0001

Size	Structure	Value
0004	LongRGB - rgbText	
0001	BYTE - red	0x00
0001	BYTE - green	0x00
0001	BYTE - blue	0x00
0001	BYTE - reserved	0x00
0004	LONG - x	0xFFFFFFFFD1
0004	LONG - y	0xFFFFFFFFC0
0004	LONG - dx	0x00000000
0004	LONG - dy	0x00000000
1 bit	USHORT - fAutoColor	0x1
1 bit	USHORT - fShowKey	0x0
1 bit	USHORT - fShowValue	0x0
1 bit	USHORT - unused1	0x0
1 bit	USHORT - fAutoText	0x1
1 bit	USHORT - fGenerated	0x1
1 bit	USHORT - fDeleted	0x0
1 bit	USHORT - fAutoMode	0x1
3 bits	USHORT - unused2	0x0
1 bit	USHORT - fShowLabelAndPerc	0x0
1 bit	USHORT - fShowPercent	0x0
1 bit	USHORT - fShowBubbleSizes	0x0
1 bit	USHORT - fShowLabel	0x0
1 bit	USHORT - reserved	0x0
0002	Icv - icvText	
0002	USHORT - icv	0x004D
4 bits	USHORT - dlp	0x0
10 bits	USHORT - unused3	0x317
2 bits	USHORT - iReadingOrder	0x0
0002	USHORT - trot	0x0000

Figure 55: Structure of Text

The position and size specified by the **x** field, **y** field, **dx** field, and **dy** field is ignored because this record is followed by a [Pos](#) record. The **fShowLabelAndPerc** field, **fShowPercent** field, **fShowBubbleSizes** field, **fShowLabel** field, and **dlp** field are ignored because this is a column chart.

at: 0x02 specifies that the horizontal alignment of the text is center-alignment.

vat: 0x02 specifies that the vertical alignment of the text is center-alignment.

wBkgMode: 0x0001 specifies that the background of the text is transparent.

rgbText: Specifies the color of the text.

fAutoColor: 0x0001 specifies that the foreground color is determined automatically.

fAutoText: 0x0001 specifies that the text value of the text field is automatically generated and has not been changed.

fGenerated: 0x0001 specifies that the properties of the text field are automatically generated and was not changed.

fAutoMode: 0x0001 specifies that the background color is determined automatically.

icvText: Specifies a color in the color table.

icvText.icv: 0x004D specifies that the default chart foreground color is used.

iReadingOrder: 0x0000 specifies that the reading order is based on the context.

trot: 0x0000 specifies that the text is not rotated.

(Records following this record, and before the next [FontX](#) record, are omitted for brevity.)

3.6.15 Column Chart Object: FontX

The next record in this example, [FontX](#), specifies the font used for text of this chart.

Size	Structure	Value
0002	FontX - FontX	
0002	USHORT - iFont	0x0005

Figure 56: Structure of FontX

iFont: 0x0005 specifies that the referenced font is the fifth [Font](#) record in the [chart sheet substream](#).

(Records following this record, and before the next [AxesUsed](#) record, are omitted for brevity.)

3.6.16 Column Chart Object: AxesUsed

The next record in this example, [AxesUsed](#), specifies the number of [axis groups](#) on the [chart](#).

Size	Structure	Value
0002	AxesUsed - AxesUsed	
0002	USHORT - cAxes	0x0001

Figure 57: Structure of AxesUsed

cAxes: 0x0001 specifies that this chart contains a single primary axis group.

3.6.17 Column Chart Object: AxisParent

The next record in this example, [AxisParent](#), specifies the properties of an [axis group](#) and specifies the beginning of a collection of records as defined by the [chart sheet substream](#) that specifies an Axis Group.

Size	Structure	Value
0012	AxisParent - AxisParent	
0002	SHORT - iax	0x0000
0010	Unused - unused	5D 00 00 00 81 00 00 00 E6 0E 00 00 10 0D 00 00

Figure 58: Structure of AxisParent

iax: 0x0000 specifies that the Axis Group specified by the records following this record is primary.

Records following this record, and before the next [Axis](#) record, are omitted for brevity.

3.6.18 Column Chart Object: Axis

The next record in this example, [Axis](#), specifies properties of an [axis](#) and specifies the beginning of a collection of records as defined by the [chart sheet substream](#) that specifies the **category (2)** axis.

Size	Structure	Value
0012	Axis - Axis	
0002	WORD - wType	0x0000
0004	ULONG - reserved1	0x00000000
0004	ULONG - reserved2	0x00000000
0004	ULONG - reserved3	0x00000000
0004	ULONG - reserved4	0x00000000

Figure 59: Structure of Axis

wType: 0x0000 specifies that the axis type is category (2) axis.

(Records following this record, and before the next [CatSerRange](#) record, are omitted for brevity.)

3.6.19 Column Chart Object: CatSerRange

The next record in this example, [CatSerRange](#), specifies the properties of the **category (2)** axis.

Size	Structure	Value
0008	CatSerRange - CatSerRange	
0002	SHORT - catCross	0x0001
0002	SHORT - catLabel	0x0001
0002	SHORT - catMark	0x0001
1 bit	USHORT - fBetween	0x1

Size	Structure	Value
1 bit	USHORT - fMaxCross	0x0
1 bit	USHORT - fReverse	0x0
13 bits	USHORT - reserved	0x0000

Figure 60: Structure of CatSerRange

catCross: 0x0001 specifies the category (2) axis is crossed by the value axis at the first category (2).

catLabel: 0x0001 specifies that the number of categories (2) between **major tick mark** labels is 1.

catMark: 0x0001 specifies that the number of categories (2) between major tick marks is 1.

fBetween: 0x0001 specifies that the value axis crosses the category (2) axis between two major tick marks.

fMaxCross: 0x0000 specifies that the value axis crosses the category (2) axis at the category specified by the **catCross** field.

fReverse: 0x0000 specifies that categories (2) are displayed in order.

3.6.20 Column Chart Object: Tick

The next record in this example, [Tick](#), specifies the properties of the **major tick marks** and **minor tick marks** associated with the **category (2) axis**.

Size	Structure	Value
001E	Tick - Tick	
0001	BYTE - tkMajor	0x02
0001	BYTE - tkMinor	0x00
0001	BYTE - tlt	0x03
0001	BYTE - wBkgMode	0x01
0004	LongRGB - rgb	
0001	BYTE - red	0x00
0001	BYTE - green	0x00
0001	BYTE - blue	0x00
0001	BYTE - reserved	0x00
0004	LONG - reserved1	0x00000000
0004	LONG - reserved2	0x00000000
0004	LONG - reserved3	0x00000000
0004	LONG - reserved4	0x00000000
1 bit	USHORT - fAutoCo	0x1
1 bit	USHORT - fAutoMode	0x1

Size	Structure	Value
3 bits	USHORT - rot	0x0
1 bit	USHORT - fAutoRot	0x1
8 bits	USHORT - unused	0x00
2 bits	USHORT - iReadingOrder	0x0
0002	IcvChart - icv	
0002	USHORT - icv	0x004D
0002	SHORT - trot	0x0000

Figure 61: Structure of Tick

The **rgb** field is ignored because the **fAutoCo** field is equal to 0x0001. The **wBkgMode** field is ignored because the **fAutoMode** field is equal to 0x0001. The **rot** field is ignored because the **fAutoRot** field is equal to 0x0001.

tkMajor: 0x02 specifies that the location of the major tick marks is outside, which indicates that the major tick marks are drawn away from the **plot area**.

tkMinor: 0x00 specifies that no minor tick marks are present on the axis.

tl: 0x03 specifies to place axis labels next to the axis.

fAutoCo: 0x0001 specifies that the text uses an automatically selected foreground color, based on the display settings of the computer.

fAutoMode: 0x0001 specifies that the background mode is set according to the [DefaultText](#) settings of the chart

fAutoRot: 0x0001 specifies that the text rotation of axis labels is determined automatically.

iReadingOrder: 0x0000 specifies that the **reading order** of the axis label is determined by the application.

icv.icv: 0x004D specifies that the foreground color is the default chart foreground color. This is the window text color in the chart display.

trot: 0x0000 specifies that the axis label is not rotated.

(Records following this record, and before the next [ChartFormat](#) record, are omitted for brevity.) The collection of records includes a collection of record beginning with the [Axis](#) record that specifies the value axis for this chart.

3.6.21 Column Chart Object: ChartFormat

The next record in this example, [ChartFormat](#), specifies properties of this [chart group](#) and specifies the beginning of a collection of records as defined by the [chart sheet substream](#). The collection of records specifies this chart group. In this example this record is the first ChartFormat record in the collection of ChartFormat records in the current chart sheet substream.

Size	Structure	Value
0014	ChartFormat - ChartFormat	
0004	LONG - Reserved1	0x00000000

Size	Structure	Value
0004	LONG - Reserved2	0x00000000
0004	LONG - Reserved3	0x00000000
0004	LONG - Reserved4	0x00000000
1 bit	WORD - fVaried	0x0
15 bits	WORD - Reserved5	0x0000
0002	SHORT - icrt	0x0000

Figure 62: Structure of ChartFormat

fVaried: 0x0000 specifies that the color of each data point does not vary.

icrt: 0x0000 specifies that this chart group is at the bottom of the **z-order**.

3.6.22 Column Chart Object: Bar

The next record in this example, [Bar](#), specifies the attributes of this [chart group](#).

Size	Structure	Value
0006	Bar - Bar	
0002	SHORT - pcOverlap	0x0000
0002	USHORT - pcGap	0x0096
1 bit	USHORT - fTranspose	0x0
1 bit	USHORT - fStacked	0x0
1 bit	USHORT - f100	0x0
1 bit	USHORT - fHasShadow	0x0
12 bits	USHORT - reserved	0x000

Figure 63: Structure of Bar

pcOverlap: 0x0000 specifies that there is no overlap between data points.

pcGap: 0x0096 specifies that the width of the gap between adjacent **categories (2)** is 150% of the data point width. It also specifies that the width of the gap between the categories (2) and the left and right edges of the **plot area** is 75% of the data point width.

fTranspose: 0x0000 specifies that the data points and the value [axis](#) are vertical.

fStacked: 0x0000 specifies that [data points](#) in the same chart group are not stacked.

f100: 0x0000 specifies that data points in the chart group are not displayed as a percentage of the sum of all data points in the chart group that share the same category (2).

fHasShadow: 0x0000 specifies that none of the data points in the chart group has shadows.

The remaining records following this record, are omitted for brevity.

3.7 Pie Chart Sheet

This is an example of a 2D Pie [Chart Sheet](#). This example omits records previously covered in the [column chart object](#) example.

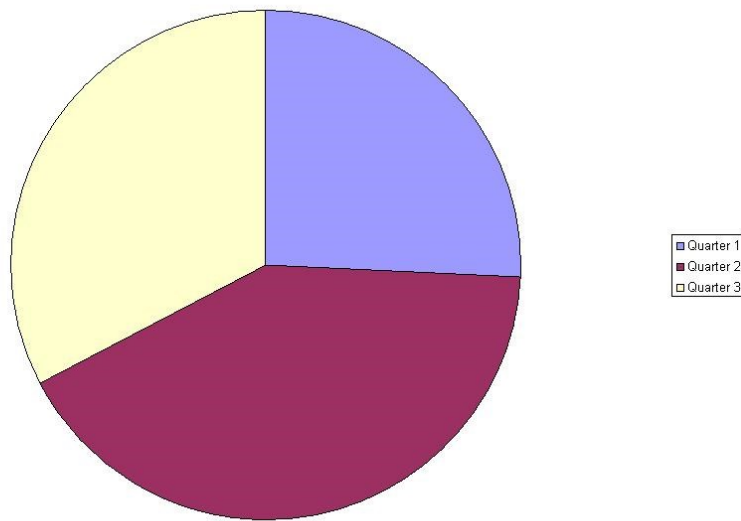

Figure 64: Pie Chart Sheet in this example within a sheet.

3.7.1 Pie Chart Sheet: PrintSize

The first record in this example, [PrintSize](#), specifies the printed size of the [chart](#).

Size	Structure	Value
0002	PrintSize - PrintSize	
0002	WORD - printSize	0x0003

Figure 65: Structure of PrintSize

printSize: 0x0003 specifies that the printed size of the chart is defined in the [Chart](#) record that follows this record.

3.7.2 Pie Chart Sheet: Chart

The next record in this example, [Chart](#), specifies the beginning of the collection of records for the [chart](#), and specifies the position and size of the **chart area** (section [2.2.3.17](#)).

Size	Structure	Value
0010	Chart - Chart	
0004	FixedPoint - x	0x00000000
0004	FixedPoint - y	0x00000000
0004	FixedPoint - dx	0x02AB0A30
0004	FixedPoint - dy	0x01D30A30

Figure 66: Structure of Chart

x: 0x00000000 specifies that the horizontal position of the upper-left corner of the chart is 0 **points**.

y: 0x00000000 specifies that the vertical position of the upper-left corner of the chart is 0 points.

dx: 0x02AB0A30 specifies that the chart is 44763696 points wide.

dy: 0x01D30A30 specifies that the chart is 30607920 points high.

3.7.3 Pie Chart Sheet: ShtProps

The next record in this example, [ShtProps](#), specifies the [chart sheet](#) properties.

Size	Structure	Value
0004	ShtProps - ShtProps	
1 bit	USHORT - fManSerAlloc	0x0
1 bit	USHORT - fPlotVisOnly	0x1
1 bit	USHORT - fNotSizeWith	0x1
1 bit	USHORT - fManPlotArea	0x1
1 bit	USHORT - fAlwaysAutoPlotArea	0x0
11 bits	USHORT - reserved1	0x000
0001	BYTE - mdBlank	0x00
0001	BYTE - reserved2	0x00

Figure 67: Structure of ShtProps

fManSerAlloc: 0x0 specifies that the data [series](#) are not automatically allocated to the series of the [chart](#).

fPlotVisOnly: 0x1 specifies to plot **visible cells** only.

fNotSizeWith: 0x1 specifies not to size the chart with the window.

fManPlotArea: This field is ignored because the **fAlwaysAutoPlotArea** value is 0x0.

fAlwaysAutoPlotArea: 0x0 specifies that the default **plot area** size is used regardless of the [Pos](#) record information.

mdBlank: 0x00 specifies that empty cells are not plotted.

3.7.4 Pie Chart Sheet: AxesUsed

The next record in this example, [AxesUsed](#), specifies the value [axes](#) used on the [chart](#).

Size	Structure	Value
0002	AxesUsed - AxesUsed	
0002	USHORT - cAxes	0x0001

Figure 68: Structure of AxesUsed

cAxes: 0x0001 specifies that a single primary value axis is present and used on the chart.

3.7.5 Pie Chart Sheet: AxisParent

The next record in this example, [AxisParent](#), specifies properties of the one [axis group](#) on the [chart](#) and specifies the beginning of the collection of records that specifies an axis group.

Size	Structure	Value
0012	AxisParent - AxisParent	
0002	SHORT - iax	0x0000
0010	unused - unused	

Figure 69: Structure of AxisParent

iax: 0x0000 specifies that this axis group is a primary axis group.

3.7.6 Pie Chart Sheet: ChartFormat

The next record, [ChartFormat](#), specifies properties of a [chart group](#) and specifies the beginning of the collection of records that specifies further properties of that chart group.

Size	Structure	Value
0014	ChartFormat - ChartFormat	
0004	LONG - reserved1	0x00000000
0004	LONG - reserved2	0x00000000
0004	LONG - reserved3	0x00000000
0004	LONG - reserved4	0x00000000
1 bit	WORD - fVaried	0x1
15 bits	WORD - reserved5	0x0000
0002	SHORT - icrt	0x0000

Figure 70: Structure of ChartFormat

fVaried: 0x0001 specifies that the color for each [data point](#), or the color or type for each **data marker** varies.

icrt: 0x0000 specifies that the drawing order of the chart group relative to the other chart groups is the bottom of the **z-order**.

3.7.7 Pie Chart Sheet: Pie

The next record in this example, [Pie](#), specifies that this is a pie [chart group](#), and specifies attributes of the chart group.

Size	Structure	Value
0006	Pie - Pie	
0002	USHORT - anStart	0x0000

Size	Structure	Value
0002	USHORT - pcDonut	0x0000
1 bit	USHORT - fHasShadow	0x0
1 bit	USHORT - fShowLdrLines	0x1
14 bits	USHORT - reserved	0x0000

Figure 71: Structure of Pie

anStart: 0x0000 specifies that the starting angle, calculated clockwise from the top of the circle, of the first [data point](#) is 0 degrees.

pcDonut: 0x0000 specifies that the chart group is a pie chart group.

fHasShadow: 0x0 specifies that zero data points in the chart group have shadows.

fShowLdrLines: 0x1 specifies that the **leader lines** to the [data labels](#) are shown. This value is ignored because zero data labels are present in this example.

3.7.8 Pie Chart Sheet: Legend

The next record in this example, [Legend](#), specifies the location of the [legend](#) on the display and its overall size. The displayed legend contains all the [series](#) on the [chart](#). The position and size information specified in this record is ignored, and the position and size information specified in the following [Pos](#) record is used.

Size	Structure	Value
0014	Legend - Legend	
0004	ULONG - x	0x00000E47
0004	ULONG - y	0x00000703
0004	ULONG - dx	0x00000147
0004	ULONG - dy	0x00000199
0001	BYTE - unused	0x03
0001	BYTE - wSpace	0x01
1 bit	WORD - fAutoPosition	0x1
1 bit	WORD - reserved1	0x1
1 bit	WORD - fAutoPosX	0x1
1 bit	WORD - fAutoPosY	0x1
1 bit	WORD - fVert	0x1
1 bit	WORD - fWasDataTable	0x0
10 bits	WORD - reserved2	0x000

Figure 72: Structure of Legend

wSpace: 0x01 specifies that there are 40 **twips** between **legend entries**.

fAutoPosition: 0x1 specifies that the legend is automatically positioned.

fAutoPosX: 0x1 specifies that the x-positioning of the legend is automatic.

fAutoPosY: 0x1 specifies that the y-positioning of the legend is automatic.

fVert: 0x1 specifies that the layout of the legend entries contain a single column of entries.

fWasDataTable: 0x0 specifies that the chart is not displaying the chart [data table](#).

The next record in this example, [Begin](#), specifies the beginning of the collection of records that specifies the properties of the legend.

The details of the Begin record have been omitted from the example for brevity.

3.7.9 Pie Chart Sheet: Pos

The next record in this example, [Pos](#), specifies the size and position for the [Legend](#) of the **plot area**.

Size	Structure	Value
0014	Pos - Pos	
0002	PositionMode - mdTopLt	0x0005
0002	PositionMode - mdBotRt	0x0002
0002	SHORT - x1	0x0E47
0002	SHORT - unused1	0x0000
0002	SHORT - y1	0x0703
0002	SHORT - unused2	0x0000
0002	SHORT - x2	0x0000
0002	SHORT - unused3	0x0000
0002	SHORT - y2	0x0000
0002	SHORT - unused4	0x0000

Figure 73: Structure of Pos

Fields in this record that are ignored because **mdTopLt** is 0x0005 and **mdBotRt** is 0x0002 are omitted for brevity.

mdTopLt: 0x0005 specifies that the horizontal offset of the upper-left corner for this Legend is relative to the upper-left corner of the **chart area** (section [2.2.3.17](#)), measured in [SPRC](#).

mdBotRt: 0x0002, when combined with the **mdTopLt** value of 0x0005, specifies that the values of **x1** and **y1** specify the horizontal and vertical offsets of the upper-left corner of the Legend, relative to the upper-left corner of the chart area (section [2.2.3.17](#)).

x1: 0x0E47 specifies that the upper-left corner of the Legend is horizontally offset by 3655 SPRC from the upper-left corner of the chart area (section [2.2.3.17](#)).

y1: 0x0703 specifies that the upper-left corner of the Legend is vertically offset by 1795 SPRC from the upper-left corner of the chart area (section [2.2.3.17](#)).

3.7.10 Pie Chart Sheet: Text

The next record in this example, [Text](#), specifies the position and appearance of text fields that appear on the [chart](#). The position and size information specified in this record are ignored because this record is followed by a [Pos](#) record.

Size	Structure	Value
0020	Text - Text	
0001	BYTE - at	0x02
0001	BYTE - vat	0x02
0002	WORD - wBkgMode	0x0001
0004	LongRGB - rgbText	
0001	BYTE - red	0x00
0001	BYTE - green	0x00
0001	BYTE - blue	0x00
0001	BYTE - reserved	0x00
0004	LONG - x	0xFFFFFFFFEA
0004	LONG - y	0xFFFFFFFF75
0004	LONG - dx	0x00000000
0004	LONG - dy	0x00000000
1 bit	USHORT - fAutoColor	0x1
1 bit	USHORT - fShowKey	0x0
1 bit	USHORT - fShowValue	0x0
1 bit	USHORT - unused1	0x0
1 bit	USHORT - fAutoText	0x1
1 bit	USHORT - fGenerated	0x1
1 bit	USHORT - fDeleted	0x0
1 bit	USHORT - fAutoMode	0x1
3 bits	USHORT - unused2	0x0
1 bit	USHORT - fShowLabelAndPerc	0x0
1 bit	USHORT - fShowPercent	0x0
1 bit	USHORT - fShowBubbleSizes	0x0
1 bit	USHORT - fShowLabel	0x0
1 bit	USHORT - reserved	0x0
0002	Icv - icvText	

Size	Structure	Value
0002	USHORT - icv	0x004D
4 bits	USHORT - dlp	0x0
10 bits	USHORT - unused3	0x069
2 bits	USHORT - iReadingOrder	0x0
0002	USHORT - trot	0x0000

Figure 74: Structure of Text

at: 0x02 specifies that the horizontal alignment of the text fields that appear in the [Legend](#) record is center-aligned.

vat: 0x02 specifies that the vertical alignment of the text fields that appear in the Legend record is center-aligned.

wBkgMode: 0x0001 specifies that the background of the text is transparent.

rgbText: A LongRGB structure that specifies the color of the text.

rgbText.red: 0x00 specifies that the relative intensity of red is 0.

rgbText.green: 0x00 specifies that the relative intensity of green is 0.

rgbText.blue: 0x00 specifies that the relative intensity of blue is 0.

fAutoColor: 0x0001 specifies that the foreground text color is determined automatically.

fShowKey: This field is ignored because this [AttachedLabel](#) is not a [data label](#).

fShowValue: This field is ignored because this AttachedLabel is not a data label.

fAutoText: 0x0001 specifies that the text value of the text field is automatically generated and has not been changed.

fGenerated: 0x0001 specifies that the properties of the text field are automatically generated and have not been changed.

fDeleted: 0x0000 specifies that this text field, which is displayed by default, has been deleted by the user.

fAutoMode: 0x0001 specifies that the background color is determined automatically.

fShowLabelAndPerc: This field is ignored because this AttachedLabel is not a data label.

fShowPercent: This field is ignored because this AttachedLabel is not a data label.

fShowBubbleSizes: This field is ignored because this AttachedLabel is not a data label.

fShowLabel: This field is ignored because this AttachedLabel is not a data label.

icvText: An Icv structure that specifies the color of the text.

icvText.icv: 0x004D specifies that the default chart foreground color is used.

dlp: This field is ignored because this AttachedLabel is not a data label.

iReadingOrder: 0x0000 specifies that the **reading order** of the text is determined by the application.

trot: This field is ignored because this AttachedLabel is not a data label.

The next record in this example, [Begin](#), specifies the beginning of the collection of records that specifies data labels on a **graph object**.

The details of the Begin record have been omitted from the example for brevity.

3.7.11 Pie Chart Sheet: BRAI

The next record in this example, [BRAI](#), specifies a reference to data in a **sheet** that is used by a **legend entry**.

Size	Structure	Value
0008	BRAI - BRAI	
0001	BYTE - id	0x00
0001	BYTE - rt	0x01
1 bit	USHORT - fUnlinkedIfmt	0x0
15 bits	USHORT - reserved	0x0000
0002	IFmt - ifmt	0x0000
0002	ChartParsedFormula - formula	
0002	WORD - cce	0x0000

Figure 75: Structure of BRAI

id: 0x00 specifies that the referenced data is used for the text of a legend entry.

rt: 0x01 specifies that the **data source** is text or the value contained by the **rgce** field.

fUnlinkedIfmt: 0x0 specifies that the data uses the same number formatting as the referenced data.

ifmt: 0x0000 specifies that the identifier for **number format** information is general (automatic).

formula: A ChartParsedFormula that specifies the formula (section [2.2.2](#)) that specifies the referenced data.

formula.cce: 0x0000 specifies that the length of **rgce** is 0 bytes.

The next two records in this example are both [End](#) records. The first End record specifies the end of the collection of records that specifies [data labels](#) on a **graph object**. The second End record specifies the end of the collection of records that specifies the [legend](#).

The details of the End records have been omitted from the example for brevity.

3.7.12 Pie Chart Sheet: Window2

The next record in this example, [Window2](#), specifies attributes of the window used to display a **sheet** in a **workbook**.

Size	Structure	Value
000A	WINDOW2 - Window2	
1 bit	USHORT - fDspFmlaRt	0x0

Size	Structure	Value
1 bit	USHORT - fDspGridRt	0x1
1 bit	USHORT - fDspRwColRt	0x0
1 bit	USHORT - fFrozenRt	0x0
1 bit	USHORT - fDspZerosRt	0x0
1 bit	USHORT - fDefaultHdr	0x0
1 bit	USHORT - fRightToLeft	0x0
1 bit	USHORT - fDspGuts	0x0
1 bit	USHORT - fFrozenNoSplit	0x0
1 bit	USHORT - fSelected	0x1
1 bit	USHORT - fPaged	0x1
1 bit	USHORT - fSLV	0x0
4 bits	USHORT - reserved1	0x0
0002	RwU - rwTop	0x0000
0002	ColU - colLeft	0x0000
0002	Icv - icvHdr	0x0000
0002	USHORT - reserved2	0x0000

Figure 76: Structure of Window2

Fields in this record that are ignored because this Window2 record is contained in a [chart sheet](#) substream are omitted for brevity.

fSelected: 0x1 specifies that the sheet tab of the chart sheet is selected.

3.8 Formatting

In this example, **cell** formatting and **number formats** are applied to three cells in the **sheet**:

Cell B3, containing 1.2345, is formatted with the built-in "0.00" number format.

Cell B4, containing 1.2345, is formatted with the custom number format "0.00000".

Cell B5, containing "1.2345", is formatted with a blue **foreground color**, yellow **background color**, and is bold.

The following screenshot shows a possible implementation of the cells discussed in this example:

	A	B	C	D
1				
2				
3		1.23		
4		1.23450		
5		1.2345		
6				
7				
8				

Figure 77: The formatting in this example within a sheet

This example starts at the first [Font](#) record in the [Workbook stream](#) related to these cells and ends at the [Number](#) record containing the value for the last cell. Other records in the Workbook stream or related substreams which are not related to this example are omitted for brevity. The substream of the [workbook](#) related to this example contains five [Font](#) records, nine [Format](#) records, 24 [XF](#) records, and three [Number](#) records. Of these, the example highlights the first and fifth [Font](#) record, the last [Format](#) record, the first, sixteenth, seventeenth, and eighteenth [XF](#) records, and all three [Number](#) records. Any other records in the substream are skipped in this example.

Each [Number](#) record that specifies a cell with a **floating-point number** corresponds to one of the three cells in this example. The [Number](#) record contains a [Cell](#) structure, which in turn contains an [IXFCell](#) structure with an **ixfe** field containing the index to an [XF](#) record in the [Globals Substream](#). The [XF](#) record that specifies formatting properties for a cell contains a [FontIndex](#) structure and an [IFmt](#) structure. Those records contain indexes for a [Font](#) record and a [Format](#) record, respectively. The [Font](#) record specifies **font** and font formatting information, and the [Format](#) record specifies a number format.

3.8.1 Formatting: Font 1

The first record in the example, [Font](#), specifies the **font** and font formatting information which is used by **cells** B3 and B4.

Size	Structure	Value
001A	Font - Font	
0002	USHORT - dyHeight	0x00C8
1 bit	USHORT - unused1	0x0
1 bit	USHORT - fItalic	0x0
1 bit	USHORT - unused2	0x0
1 bit	USHORT - fStrikeOut	0x0
1 bit	USHORT - fOutline	0x0
1 bit	USHORT - fShadow	0x0
1 bit	USHORT - fCondense	0x0
1 bit	USHORT - fExtend	0x0
8 bits	USHORT - reserved	0x00
0002	USHORT - icv	0x7FFF

Size	Structure	Value
0002	USHORT - bls	0x0190
0002	USHORT - sss	0x0000
0001	BYTE - uls	0x00
0001	BYTE - bFamily	0x00
0001	BYTE - bCharSet	0x00
0001	BYTE - unused3	0xDF
000C	ShortXLUnicodeString - fontName	Arial

Figure 78: Structure of Font

dyHeight: 0x00C8 specifies the height of the font is 200 **twips**.

fItalic: 0x0 specifies that the font is not italicized.

fStrikeOut: 0x0 specifies that the font does not have **strikethrough formatting** applied.

fOutline: 0x0 specifies that the font is not an outline.

fShadow: 0x0 specifies that the font does not have a shadow applied.

fCondense: 0x0 specifies that the font is not condensed by compressing spacing between characters.

fExtend: 0x0 specifies that the font is not extended by stretching spacing between characters.

icv: 0x7FFF is an [Icv](#) value that specifies that the color of the font is the default **foreground color**.

bls: 0x0190 specifies that the font is normal weight.

sss: 0x0000 specifies that the font is normal script.

uls: 0x00 specifies that the font has no underline.

bFamily: 0x00 specifies that the **font family** of the font is not applicable as detailed in the Windows API LOGFONT structure in [\[MSDN-FONTS\]](#).

bCharSet: 0x00 specifies that that this font belongs to the **ANSI character set**.

fontName: Arial specifies the name of the font.

Records following this record, and before the fifth Font record, are omitted for brevity.

3.8.2 Formatting: Font 2

The next record in this example, [Font](#), specifies the **font** and font formatting information which is used by **cell B5**.

Size	Structure	Value
001A	Font - Font	
0002	USHORT - dyHeight	0x00C8
1 bit	USHORT - unused1	0x0

Size	Structure	Value
1 bit	USHORT - fItalic	0x0
1 bit	USHORT - unused2	0x0
1 bit	USHORT - fStrikeOut	0x0
1 bit	USHORT - fOutline	0x0
1 bit	USHORT - fShadow	0x0
1 bit	USHORT - fCondense	0x0
1 bit	USHORT - fExtend	0x0
8 bits	USHORT - reserved	0x00
0002	USHORT - icv	0x000C
0002	USHORT - bls	0x02BC
0002	USHORT - sss	0x0000
0001	BYTE - uls	0x00
0001	BYTE - bFamily	0x00
0001	BYTE - bCharSet	0x00
0001	BYTE - unused3	0xDF
000C	ShortXLUnicodeString - fontName	Arial

Figure 79: Structure of Font

Fields in this record that are explained in previous records in this example have been omitted for brevity.

icv: 0x000C is an [Icv](#) value that specifies that the color of the font is composed of an RGB value with a red value of 0, a green value of 0, and a blue value of 255, representing the color blue.

bls: 0x02BC specifies that the font is bold.

Records following this record, and before the ninth [Format](#) record, are omitted for brevity.

3.8.3 Formatting: Format

The next record in this example, [Format](#), specifies the number format which is used by **cell** B4.

Size	Structure	Value
000C	Format - Format	
0002	IFmt - ifmt	0x00A4
000A	XLUnicodeString - stFormat	0.00000

Figure 80: Structure of Format

ifmt: 0x00A4 specifies the identifier of the format string.

stFormat: "0.00000" specifies the custom **number format** string to be applied.

3.8.4 Formatting: XF 1

The next record in this example, [XF](#), specifies default formatting properties for a **cell** and is written out. It is not referenced in this example.

Size	Structure	Value
0014	XF - XF	
0002	FontIndex - ifnt	
0002	USHORT - ifnt	0x0000
0002	IFmt - ifmt	
0002	USHORT - ifmt	0x0000
1 bit	USHORT - fLocked	0x1
1 bit	USHORT - fHidden	0x0
1 bit	USHORT - fStyle	0x1
1 bit	USHORT - f123Prefix	0x0
12 bits	USHORT - ixfParent	0xFF
000E	StyleXF - Data	
3 bits	BYTE - alc	0x0
1 bit	BYTE - fWrap	0x0
3 bits	BYTE - alcV	0x2
1 bit	BYTE - fJustLast	0x0
0001	XFPropTextRotation - trot	
0001	BYTE - trot	0x00
4 bits	BYTE - cIndent	0x0
1 bit	BYTE - fShrinkToFit	0x0
1 bit	BYTE - reserved1	0x0
2 bits	BYTE - iReadOrder	0x0
0001	BYTE - unused	0x00
4 bits	USHORT - dgLeft	0x0
4 bits	USHORT - dgRight	0x0
4 bits	USHORT - dgTop	0x0
4 bits	USHORT - dgBottom	0x0
7 bits	USHORT - icvLeft	0x00
7 bits	USHORT - icvRight	0x00
2 bits	USHORT - grbitDiag	0x0

Size	Structure	Value
7 bits	ULONG - icvTop	0x00
7 bits	ULONG - icvBottom	0x00
7 bits	ULONG - icvDiag	0x00
4 bits	ULONG - dgDiag	0x0
1 bit	ULONG - reserved2	0x0
6 bits	ULONG - fls	0x00
7 bits	USHORT - icvFore	0x40
7 bits	USHORT - icvBack	0x41
2 bits	USHORT - reserved3	0x0

Figure 81: Structure of XF

ifnt: Specifies formatting properties for the cell.

ifnt.ifnt: 0x0000 specifies the [FontIndex](#) that specifies the cell uses the default **font**.

ifmt: Specifies the **number format** and text formatting for the cell.

ifmt.ifmt: 0x0000 specifies an IFmt that specifies general (automatic) formatting for the cell.

fLocked: 0x1 specifies that the cell is set to be **locked** for user editing when the worksheet is **protected**.

fHidden: 0x0 specifies that the cell formula is not **hidden** when the worksheet is protected.

fStyle: 0x1 specifies that this record specifies a [cell style](#).

f123Prefix: 0x0 specifies that the text in the cell is not prefixed by a single quote mark.

ixfParent: 0xFFF is the required value as **fStyle** is 0x1.

Data: Specifies additional properties of this cell style.

Data.alc: 0x0 specifies that the horizontal alignment of the cell is **general alignment**.

Data.fWrap: 0x0 specifies that the cell text is not line-wrapped within the cell.

Data.alcV: 0x2 specifies that the cell has a bottom **vertical alignment**.

Data.fJustLast: 0x0 specifies that the cell text is not **justify distributed**.

Data.trot: Specifies the text rotation.

Data.trot.trot: 0x00 specifies that the cell text is rotated counterclockwise 0 degrees.

Data.cIndent: 0x0 specifies that the cell text is not indented.

Data.fShrinkToFit: 0x0 specifies that the cell is not **shrink to fit**.

Data.iReadOrder: 0x0 specifies that the **reading order** of the cell is context reading order.

Data.dgLeft: 0x0 specifies that the **logical left border formatting** of the cell is no **border**.

Data.dgRight: 0x0 specifies that the **logical right** border formatting of the cell is no border.

Data.dgTop: 0x0 specifies that the top border formatting of the cell is no border.

Data.dgBottom: 0x0 specifies that the bottom border formatting of the cell is no border.

Data.icvLeft: 0x00 specifies that the color of the logical left border is not specified.

Data.icvRight: 0x00 specifies that the color of the logical right border is not specified.

Data.grbitDiag: 0x0 specifies that the cell does not have a diagonal border.

Data.icvTop: 0x00 specifies that the color of the top border is not specified.

Data.icvBottom: 0x00 specifies that the color of the bottom border is not specified.

Data.icvDiag: 0x00 specifies that the color of the diagonal border is not specified.

Data.dgDiag: 0x0 specifies that the diagonal border formatting of the cell is no border.

Data.fls: 0x00 specifies that there is no **fill pattern** for the cell.

Data.icvFore: 0x40 specifies that the **foreground color** of the fill pattern is the default foreground color.

Data.icvBack: 0x41 specifies that the **background color** of the fill pattern is the default background color.

Records following this record, and before the sixteenth XF record, are omitted for brevity.

3.8.5 Formatting: XF 2

The next record in this example, [XF](#), specifies formatting properties for a **cell** and is referenced by the [Number](#) record for cell B3.

Size	Structure	Value
0014	XF - XF	
0002	FontIndex - ifnt	
0002	USHORT - ifnt	0x0000
0002	IFmt - ifmt	
0002	USHORT - ifmt	0x0002
1 bit	USHORT - fLocked	0x1
1 bit	USHORT - fHidden	0x0
1 bit	USHORT - fStyle	0x0
1 bit	USHORT - f123Prefix	0x0
12 bits	USHORT - ixfParent	0x000
000E	CellXF - Data	
3 bits	BYTE - alc	0x0
1 bit	BYTE - fWrap	0x0
3 bits	BYTE - alcV	0x2

Size	Structure	Value
1 bit	BYTE - fJustLast	0x0
0001	XFPropTextRotation - trot	
0001	BYTE - trot	0x00
4 bits	BYTE - cIndent	0x0
1 bit	BYTE - fShrinkToFit	0x0
1 bit	BYTE - reserved1	0x0
2 bits	BYTE - iReadOrder	0x0
2 bits	BYTE - reserved2	0x0
1 bit	BYTE - fAtrNum	0x1
1 bit	BYTE - fAtrFmt	0x0
1 bit	BYTE - fAtrAlc	0x0
1 bit	BYTE - fAtrBdr	0x0
1 bit	BYTE - fAtrPat	0x0
1 bit	BYTE - fAtrProt	0x0
4 bits	USHORT - dgLeft	0x0
4 bits	USHORT - dgRight	0x0
4 bits	USHORT - dgTop	0x0
4 bits	USHORT - dgBottom	0x0
7 bits	USHORT - icvLeft	0x00
7 bits	USHORT - icvRight	0x00
2 bits	USHORT - grbitDiag	0x0
7 bits	ULONG - icvTop	0x00
7 bits	ULONG - icvBottom	0x00
7 bits	ULONG - icvDiag	0x00
4 bits	ULONG - dgDiag	0x0
1 bit	ULONG - fHasXFExt	0x0
6 bits	ULONG - fls	0x00
7 bits	USHORT - icvFore	0x40
7 bits	USHORT - icvBack	0x41
1 bit	USHORT - fsxButton	0x0
1 bit	USHORT - reserved3	0x0

Figure 82: Structure of XF

Fields in this record that are explained in previous records in this example have been omitted for brevity.

ifmt: Specifies the **number format** and text formatting for the cell.

ifmt.ifmt: 0x0002 specifies an IFmt value that specifies a number format with two decimals and no 1000s comma.

fStyle: 0x0 specifies that the cell uses a cell format.

ixfParent: 0x000 specifies that the cell inherits formatting properties from the first [cell style XF](#) record in the [Globals Substream](#).

Data: Specifies additional properties of the cell format.

Data.fAtrNum: 0x1 specifies that the **ifmt** field of this XF record is not updated when the corresponding field of the XF record specified by the **ixfParent** field of this XF record is changed.

Data.fAtrFmt: 0x0 specifies that the **ifnt** field of this XF record is updated when the corresponding field of the XF record specified by the **ixfParent** field of this XF record is changed.

Data.fAtrAlc: 0x0 specifies that the **alc**, **fWrap**, **alcV**, **fJustLast**, **trot**, **cIndent**, **fShrinkToFit**, and **iReadOrder** fields are updated when the corresponding fields of the XF record specified by the **ixfParent** field of this XF record are changed.

Data.fAtrBdr: 0x0 specifies that the **dgLeft**, **dgRight**, **dgTop**, **dgBottom**, **dgDiag**, **icvLeft**, **icvRight**, **grbitDiag**, **icvTop**, **icvBottom**, and **icvDiag** fields are updated when the corresponding fields of the XF record specified by the **ixfParent** field of this XF record are changed.

Data.fAtrPat: 0x0 specifies that the **fls**, **icvFore**, and **icvBack** fields are updated when the corresponding fields of the XF record specified by the **ixfParent** field of this XF record are changed.

Data.fAtrProt: 0x0 specifies that the **fLocked** and **fHidden** fields are updated when the corresponding fields of the XF record specified by the **ixfParent** field of this XF record are changed.

Data.fHasXFExt: 0x0 specifies that the information in this XF will not be extended by an [XFExt](#) record.

Data.fsxButton: 0x0 specifies that the XF record is not attached to a pivot field drop-down button.

3.8.6 Formatting: XF 3

The next record in this example, [XF](#), specifies formatting properties for a **cell** or a [cell style](#) and is referenced by the [Number](#) record for cell B4.

Size	Structure	Value
0014	XF - XF	
0002	FontIndex - ifnt	
0002	USHORT - ifnt	0x0000
0002	IFmt - ifmt	
0002	USHORT - ifmt	0x00A4

Size	Structure	Value
1 bit	USHORT - fLocked	0x1
1 bit	USHORT - fHidden	0x0
1 bit	USHORT - fStyle	0x0
1 bit	USHORT - f123Prefix	0x0
12 bits	USHORT - ixfParent	0x000
000E	CellXF - Data	
3 bits	BYTE - alc	0x0
1 bit	BYTE - fWrap	0x0
3 bits	BYTE - alcV	0x2
1 bit	BYTE - fJustLast	0x0
0001	XFPropTextRotation - trot	
0001	BYTE - trot	0x00
4 bits	BYTE - cIndent	0x0
1 bit	BYTE - fShrinkToFit	0x0
1 bit	BYTE - reserved1	0x0
2 bits	BYTE - iReadOrder	0x0
2 bits	BYTE - reserved2	0x0
1 bit	BYTE - fAtrNum	0x1
1 bit	BYTE - fAtrFnt	0x0
1 bit	BYTE - fAtrAlc	0x0
1 bit	BYTE - fAtrBdr	0x0
1 bit	BYTE - fAtrPat	0x0
1 bit	BYTE - fAtrProt	0x0
4 bits	USHORT - dgLeft	0x0
4 bits	USHORT - dgRight	0x0
4 bits	USHORT - dgTop	0x0
4 bits	USHORT - dgBottom	0x0
7 bits	USHORT - icvLeft	0x00
7 bits	USHORT - icvRight	0x00
2 bits	USHORT - grbitDiag	0x0
7 bits	ULONG - icvTop	0x00

Size	Structure	Value
7 bits	ULONG - icvBottom	0x00
7 bits	ULONG - icvDiag	0x00
4 bits	ULONG - dgDiag	0x0
1 bit	ULONG - fHasXFExt	0x0
6 bits	ULONG - fls	0x00
7 bits	USHORT - icvFore	0x40
7 bits	USHORT - icvBack	0x41
1 bit	USHORT - fsxButton	0x0
1 bit	USHORT - reserved3	0x0

Figure 83: Structure of XF

Fields in this record that are explained in previous records in this example have been omitted for brevity.

ifmt: Specifies the **number format** and text formatting for the cell.

ifmt.ifmt: 0x00A4 specifies the first user-defined [Format](#) record illustrated previously. The formatting string specified by the referenced Format record is "0.00000".

3.8.7 Formatting: XF 4

The next record in this example, [XF](#), specifies formatting properties for a **cell** or a [cell style](#) and is referenced by the [Number](#) record for cell B5.

Size	Structure	Value
0014	XF - XF	
0002	FontIndex - ifnt	
0002	USHORT - ifnt	0x0005
0002	IFmt - ifmt	
0002	USHORT - ifmt	0x0000
1 bit	USHORT - fLocked	0x1
1 bit	USHORT - fHidden	0x0
1 bit	USHORT - fStyle	0x0
1 bit	USHORT - f123Prefix	0x0
12 bits	USHORT - ixfParent	0x000
000E	CellXF - Data	
3 bits	BYTE - alc	0x0
1 bit	BYTE - fWrap	0x0

Size	Structure	Value
3 bits	BYTE - alcV	0x2
1 bit	BYTE - fJustLast	0x0
0001	XFPropTextRotation - trot	
0001	BYTE - trot	0x00
4 bits	BYTE - cIndent	0x0
1 bit	BYTE - fShrinkToFit	0x0
1 bit	BYTE - reserved1	0x0
2 bits	BYTE - iReadOrder	0x0
2 bits	BYTE - reserved2	0x0
1 bit	BYTE - fAtrNum	0x0
1 bit	BYTE - fAtrFmt	0x1
1 bit	BYTE - fAtrAlc	0x0
1 bit	BYTE - fAtrBdr	0x0
1 bit	BYTE - fAtrPat	0x1
1 bit	BYTE - fAtrProt	0x0
4 bits	USHORT - dgLeft	0x0
4 bits	USHORT - dgRight	0x0
4 bits	USHORT - dgTop	0x0
4 bits	USHORT - dgBottom	0x0
7 bits	USHORT - icvLeft	0x00
7 bits	USHORT - icvRight	0x00
2 bits	USHORT - grbitDiag	0x0
7 bits	ULONG - icvTop	0x00
7 bits	ULONG - icvBottom	0x00
7 bits	ULONG - icvDiag	0x00
4 bits	ULONG - dgDiag	0x0
1 bit	ULONG - fHasXFExt	0x0
6 bits	ULONG - fls	0x01
7 bits	USHORT - icvFore	0x0D
7 bits	USHORT - icvBack	0x40
1 bit	USHORT - fsxButton	0x0

Size	Structure	Value
1 bit	USHORT - reserved3	0x0

Figure 84: Structure of XF

Fields in this record that are explained in previous records in this example have been omitted for brevity.

ifnt: Specifies formatting properties for the cell.

ifnt.ifnt: 0x0005 specifies a [FontIndex](#) which specifies the first [Font](#) record in the collection of Font records in the [Globals Substream](#). This Font record is illustrated previously.

Data: Specifies additional properties of the cell format.

Data.fAtrNum: 0x0 specifies that the **ifnt** field of this XF record is updated when the corresponding field of the XF record specified by the **ixfParent** field of this XF record is changed.

Data.fAtrFmt: 0x1 specifies that the **ifnt** field of this XF record is not updated when the corresponding field of the XF record specified by the **ixfParent** field of the containing XF record is changed.

Data.fAtrPat: 0x1 specifies that the **fls**, **icvFore**, and **icvBack** fields are not updated when the corresponding fields of the XF record specified by the **ixfParent** field of this XF record are changed.

Data.flc: 0x01 specifies a solid **fill pattern**. Only **icvFore** is rendered.

Data.icvFore: 0x0D specifies that the **foreground color** of the fill pattern is field **rgColor**[5] of the [Palette](#) record in the file. If no Palette record exists, the default value is an RGB value with a red value of 255, a green value of 255, and a blue value of 0, representing the color yellow.

Data.icvBack: 0x40 specifies that the **background color** of the fill pattern is the default foreground color.

Records following this record, and before the next Number record, are omitted for brevity.

3.8.8 Formatting: Number 1

The next record in this example, [Number](#), specifies the **cell** B3, which contains a **floating-point number**. This record is the first in the set of Number records in the **workbook**.

Size	Structure	Value
000E	Number - Number	
0006	Cell - cell	
0002	Rw - rw	
0002	USHORT - rw	0x0002
0002	Col - col	
0002	USHORT - col	0x0001
0002	IXFCell - ixfe	
0002	USHORT - ixfe	0x0015
0008	Double - num	3FF3C083126E978D

Figure 85: Structure of Number

cell: Specifies a cell in the current **sheet** containing a floating-point number.

cell.rw: Specifies the row index of the cell.

cell.rw.rw: 0x0002 specifies that the cell is in row 3.

cell.col: Specifies the column index of the cell.

cell.col.col: 0x0001 specifies that the cell is in column B.

cell.ixfe: Specifies the [cell XF](#) record in the collection of [XF](#) records in the [Globals Substream](#).

cell.ixfe.ixfe: 0x0015 specifies that the cell is formatted according to the first user-defined XF record in the Globals Substream. This XF is the second XF record in this example.

num: 0x3FF3C083126E978D specifies a 64-bit IEEE-754 floating-point value of 1.2345 as the value of the cell.

3.8.9 Formatting: Number 2

The next record in this example, [Number](#), specifies the **cell** B4, which contains a **floating-point number**.

Size	Structure	Value
000E	Number - Number	
0006	Cell - cell	
0002	Rw - rw	
0002	USHORT - rw	0x0003
0002	Col - col	
0002	USHORT - col	0x0001
0002	IXFCell - ixfe	
0002	USHORT - ixfe	0x0016
0008	Double - num	3FF3C083126E978D

Figure 86: Structure of Number

Fields in this record that are explained in previous records in this example have been omitted for brevity.

cell: Specifies a cell in the current **sheet** containing a floating-point number.

cell.rw: Specifies the row index of the cell.

cell.rw.rw: 0x0003 specifies that the cell is in row 4.

cell.col: Specifies the column index of the cell.

cell.col.col: 0x0001 specifies that the cell is in column B.

cell.ixfe: Specifies the [cell XF](#) record in the collection of [XF](#) records in the [Globals Substream](#).

cell.ixfe.ixfe: 0x0016 specifies that the cell is formatted according to the second user-defined XF record in the Globals Substream. This XF is the third XF record in this example.

3.8.10 Formatting: Number 3

The next record in this example, [Number](#), specifies the **cell** B5, which contains a **floating-point number**.

Size	Structure	Value
000E	Number - Number	
0006	Cell - cell	
0002	Rw - rw	
0002	USHORT - rw	0x0004
0002	Col - col	
0002	USHORT - col	0x0001
0002	IXFCell - ixfe	
0002	USHORT - ixfe	0x0017
0008	Double - num	3FF3C083126E978D

Figure 87: Structure of Number

Fields in this record that are explained in previous records in this example have been omitted for brevity.

cell: Specifies a cell in the current **sheet** containing a floating-point number.

cell.rw: Specifies the row index of the cell.

cell.rw.rw: 0x0004 specifies that the cell is in row 5.

cell.col: Specifies the column index of the cell.

cell.col.col: 0x0001 specifies that the cell is in column B.

cell.ixfe: Specifies the [cell XF](#) record in the collection of [XF](#) records in the [Globals Substream](#).

cell.ixfe.ixfe: 0x0017 specifies that the cell is formatted according to the third user-defined XF record in the Globals Substream. This XF is the fourth XF record in this example.

3.9 Workbook

This example shows a **workbook** containing three **sheets**, named "Sheet1", "Sheet2" and "Sheet3". "Sheet1" contains the following cell content:

- Cell B4 contains the string "Number".
- Cell B5 contains the number 1.
- Cell B6 contains the string "Formula".
- Cell B7 contains the formula "=SQRT(B5*2)".

The workbook example can be broken into two parts. The first part of the example includes records found in the [Globals Substream](#). These records contain details about the entire workbook through examples of the following parent records: [BOF](#), [RRTabId](#), [BuiltInFnGroupCount](#), [Window1](#), [HideObj](#), [Date1904](#), [CalcPrecision](#), [BookBool](#), [Font](#), [Format](#), [XF](#), [Style](#), [BoundSheet8](#), [Country](#), [RecalcId](#), [SST](#), [ExtSST](#), [BookExt](#), and [EOF](#).

The second part of this example contains the [Worksheet](#) substream. These records contain details about the first sheet through examples of the following parent records: [BOF](#), [Index](#), [DefaultRowHeight](#), [WsBool](#), [Setup](#), [DefColWidth](#), [Dimensions](#), [Row](#), [LabelSst](#), [RK](#), [Formula](#), [DBCell](#), [Window2](#), [Selection](#), [PhoneticInfo](#), and [EOF](#).

"Sheet2" and "Sheet3" are empty sheets and their record details are not documented in this example.

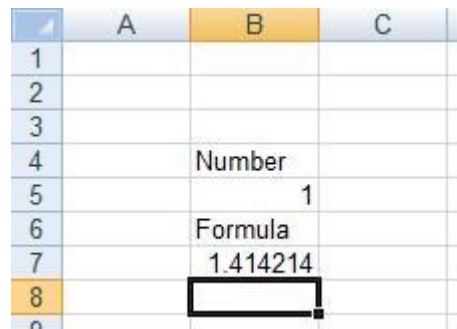

Figure 88: A sheet within a workbook

3.9.1 Workbook: BOF 1

This first [BOF](#) record begins the [Globals Substream](#) and [Workbook](#) stream and specifies global properties and data for a **workbook**, as well as the **sheets** in this example workbook.

Size	Structure	Value
0014	BOF - BOF	
0002	USHORT - vers	0x0600
0002	USHORT - dt	0x0005
0002	USHORT - rupBuild	0x2013
0002	USHORT - rupYear	0x07CD
1 bit	DWORD - fWin	0x1
1 bit	DWORD - fRisc	0x0
1 bit	DWORD - fBeta	0x0
1 bit	DWORD - fWinAny	0x0
1 bit	DWORD - fMacAny	0x0
1 bit	DWORD - fBetaAny	0x0
2 bits	DWORD - unused1	0x3
1 bit	DWORD - fRiscAny	0x0
1 bit	DWORD - fOOM	0x0

Size	Structure	Value
1 bit	DWORD - fGIJmp	0x0
2 bits	DWORD - unused2	0x0
1 bit	DWORD - fFontLimit	0x0
4 bits	DWORD - verXLHigh	0x3
1 bit	DWORD - unused3	0x0
13 bits	DWORD - reserved1	0x0000
8 bits	DWORD - verLowestBiff	0x06
4 bits	DWORD - verLastXLSaved	0x3
20 bits	DWORD - reserved2	0x00000

Figure 89: Structure of BOF

vers: 0x0600 specifies that the **BIFF** version of the file is 1536.

dt: 0x0005 specifies that the substream of records following this BOF record are part of the workbook stream.

rupBuild: 0x2013 specifies that the version of the build is 8211.

rupYear: 0x07CD specifies 1997 as the year when the file format version was first created.

fWin: 0x1 specifies that the file was last edited on a Windows platform.

fRisc: 0x0 specifies that the file was not last edited on a RISC platform.

fBeta: 0x0 specifies that the file was not last edited by a **beta** version of the application.

fWinAny: 0x0 specifies that the file has not been subsequently saved.

fMacAny: 0x0 specifies that the file has never been edited on a Macintosh platform.

fBetaAny: 0x0 specifies that the file has never been edited on a beta version of the application.

fRiscAny: 0x0 specifies that the file has never been edited on a RISC platform.

fOOM: 0x0 specifies that the file has never had an **out-of-memory** failure.

fGIJmp: 0x0 specifies that the file has never had an out-of-memory failure during rendering.

fFontLimit: 0x0 specifies that the file has never reached the 255 **font** limit.

verXLHigh: 0x3 specifies that the file was not edited in any applications after Office Excel 2003.

verLowestBiff: 0x06 specifies that the files are saved in BIFF version 6.

verLastXLSaved: 0x3 specifies that the file was last saved by Office Excel 2003.

Records following this record, and before the next [RRTabId](#) record, are omitted for brevity.

3.9.2 Workbook: RRTabId

This [RRTabId](#) record specifies unique **sheet** identifiers, each of which is associated with a sheet in the **workbook**.

Size	Structure	Value
0006	RRTabId - RRTabId	
0006	RgTabId - rgtabid	
0002	USHORT - rgtabid[0]	0x0001
0002	USHORT - rgtabid[1]	0x0002
0002	USHORT - rgtabid[2]	0x0003

Figure 90: Structure of RRTabId

rgtabid: An array of elements of unique sheet identifiers.

rgtabid.rgtabid[0]: 0x0001 specifies the first sheet identifier.

rgtabid.rgtabid[1]: 0x0002 specifies the second sheet identifier.

rgtabid.rgtabid[2]: 0x0003 specifies the third sheet identifier.

3.9.3 Workbook: BuiltInFnGroupCount

This [BuiltInFnGroupCount](#) record specifies information about the built-in **function categories** in the **workbook**.

Size	Structure	Value
0002	BuiltInFnGroupCount - BuiltinFnGroupCount	
0002	USHORT - count	0x000E

Figure 91: Structure of BuiltinFnGroupCount

count: 0x000E specifies there are 14 built-in function categories in the workbook.

Records following this record, and before the next [Window1](#) record, are omitted for brevity.

3.9.4 Workbook: Window1

This [Window1](#) record specifies attributes of the window used to display the **sheet**.

Size	Structure	Value
0012	Window1 - Window1	
0002	SHORT - xWn	0x01E0
0002	SHORT - yWn	0x0069
0002	SHORT - dxWn	0x4E1B
0002	SHORT - dyWn	0x3CE1
1 bit	USHORT - fHidden	0x0
1 bit	USHORT - fIconic	0x0
1 bit	USHORT - fVeryHidden	0x0

Size	Structure	Value
1 bit	USHORT - fDspHScroll	0x1
1 bit	USHORT - fDspVScroll	0x1
1 bit	USHORT - fBotAdornment	0x1
1 bit	USHORT - fNoAFDateGroup	0x0
9 bits	USHORT - reserved	0x000
0002	TabIndex - itabCur	
0002	USHORT - itab	0x0000
0002	TabIndex - itabFirst	
0002	USHORT - itab	0x0000
0002	USHORT - ctabSel	0x0001
0002	USHORT - wTabRatio	0x0258

Figure 92: Structure of Window1

xWn: 0x01E0 specifies that the horizontal position of the window is 480 **twips** from the logical left edge of the **client area** of the window.

yWn: 0x0069 specifies that the vertical position of the window is 105 twips from the top edge of the client area of the window.

dxWn: 0x4E1B specifies that the width of the window is 19995 twips.

dyWn: 0x3CE1 specifies that the height of the window 15585 twips.

fHidden: 0x0000 specifies that the window is not **hidden**.

fIconic: 0x0000 specifies that the window is not minimized.

fVeryHidden: 0x0000 specifies that the window is not hidden.

fDspHScroll: 0x0001 specifies that the horizontal scroll bar is displayed

fDspVScroll: 0x0001 specifies that the vertical scroll bar is displayed.

fBotAdornment: 0x0001 specifies that the **sheet tabs** are displayed.

fNoAFDateGroup: 0x0000 specifies that dates are grouped by year, month, and day in the **AutoFilter** menu.

itabCur: Specifies which sheet tab is **selected**.

itabCur.itab: 0x0000 specifies that the first sheet tab is selected.

itabFirst: Specifies which is the first displayed sheet tab.

itabFirst.itab: 0x0000 specifies that the first tab is the displayed sheet tab.

ctabSel: 0x0001 specifies that one sheet tab is selected in the **workbook**.

wTabRatio: 0x0258 specifies that the ratio of the width of the sheet tabs to the width of the horizontal scroll bar is 0.6.

Records following this record, and before the next [HideObj](#) record, are omitted for brevity.

3.9.5 Workbook: HideObj

This [HideObj](#) record specifies how **drawing objects** appear in a window that contains the **workbook**.

Size	Structure	Value
0002	HideObj - HideObj	
0002	HideObjEnum - hideObj	0x0000

Figure 93: Structure of HideObj

hideObj: 0x0000 specifies that all drawing objects in the window are shown.

3.9.6 Workbook: Date1904

This [Date1904](#) record specifies whether the **workbook** uses the 1904-based or the 1900-based **date system**.

Size	Structure	Value
0002	Date1904 - Date1904	
0002	SHORT - f1904DateSystem	0x0000

Figure 94: Structure of Date1904

f1904DateSystem: 0x0000 specifies that the workbook uses the 1900 date system.

3.9.7 Workbook: CalcPrecision

This [CalcPrecision](#) record specifies the calculation precision mode for the **workbook**.

Size	Structure	Value
0002	CalcPrecision - CalcPrec	
0002	SHORT - fFullPrec	0x0001

Figure 95: Structure of CalcPrec

fFullPrec: 0x0001 specifies that **precision as displayed** mode is not **selected**.

Records following this record, and before the next [BookBool](#) record, are omitted for brevity.

3.9.8 Workbook: BookBool

This [BookBool](#) record specifies some properties associated with the **workbook**.

Size	Structure	Value
0002	BookBool - BookBool	
1 bit	USHORT - fNoSaveSup	0x0
1 bit	USHORT - reserved1	0x0

Size	Structure	Value
1 bit	USHORT - fHasEnvelope	0x0
1 bit	USHORT - fEnvelopeVisible	0x0
1 bit	USHORT - fEnvelopeInitDone	0x0
2 bits	USHORT - grUpdateLinks	0x0
1 bit	USHORT - unused	0x0
1 bit	USHORT - fHideBorderUnselLists	0x0
7 bits	USHORT - reserved2	0x00

Figure 96: Structure of BookBool

fNoSaveSup: 0x0000 specifies that **external link** values are saved in the workbook.

fHasEnvelope: 0x0000 specifies the workbook does not have an envelope.

fEnvelopeVisible: 0x0000 specifies the envelope is not visible.

fEnvelopeInitDone: 0x0000 specifies the envelope has not been initialized.

grUpdateLinks: 0x0000 specifies the application prompts users to update external links in the workbook.

fHideBorderUnselLists: 0x0000 specifies that borders of **tables** that do not contain the active **cell** are not **hidden**.

3.9.9 Workbook: Font

This [Font](#) record specifies **font** formatting information and is the first of four in the **workbook**.

Size	Structure	Value
001A	Font - Font	
0002	USHORT - dyHeight	0x00C8
1 bit	USHORT - unused1	0x0
1 bit	USHORT - fItalic	0x0
1 bit	USHORT - unused2	0x0
1 bit	USHORT - fStrikeOut	0x0
1 bit	USHORT - fOutline	0x0
1 bit	USHORT - fShadow	0x0
1 bit	USHORT - fCondense	0x0
1 bit	USHORT - fExtend	0x0
8 bits	USHORT - reserved	0x00
0002	USHORT - icv	0x7FFF

Size	Structure	Value
0002	USHORT - bls	0x0190
0002	USHORT - sss	0x0000
0001	BYTE - uls	0x00
0001	BYTE - bFamily	0x00
0001	BYTE - bCharSet	0x00
0001	BYTE - unused3	0x57
000C	ShortXLUnicodeString - fontName	Arial

Figure 97: Structure of Font

dyHeight: 0x00C8 specifies that the height of the font is 200 **twips**.

fItalic: 0x0 specifies that the font is not italic.

fStrikeOut: 0x0 specifies that the font does not have **strikethrough formatting** applied.

fOutline: 0x0 specifies that the font does not have an **outline effect**.

fShadow: 0x0 specifies that the font does not have a **shadow effect**.

fCondense: 0x0 specifies that the font is not condensed

fExtend: 0x0 specifies that the font is not extended.

icv: 0x7FFF specifies that the color of the font is automatic and matches the window text color.

bls: 0x0190 specifies that the font weight is normal.

sss: 0x0000 specifies that no superscript or subscript is used.

uls: 0x00 specifies that the font does not have underlining.

bFamily: 0x00 specifies that the **font family** of the font is not applicable as detailed in the Windows API LOGFONT structure in [\[MSDN-FONTS\]](#).

bCharSet: 0x00 specifies that this font belongs to the **ANSI character set**.

fontName: "Arial" specifies the name of the font.

The three Font records following this record, and before the next [Format](#) record, are omitted for brevity.

3.9.10 Workbook: Format

This [Format](#) record specifies the **number format** applied to a number and is the first of eight in the **workbook**.

Size	Structure	Value
001C	Format - Format	
0002	IFmt - ifmt	0x0005
001A	XLUnicodeString - stFormat	0.00000

Figure 98: Structure of Format

ifmt: 0x0005 specifies the identifier for the formatting string.

stFormat: "0.00000" specifies the custom number format string to be applied.

The seven Format records following this record, and before the next [XF](#) record, are omitted for brevity.

3.9.11 Workbook: XF

This [XF](#) record specifies formatting properties for a **cell** and is the first of 21 XF records in the **workbook**.

Size	Structure	Value
0014	XF - Xf	
0002	FontIndex - ifnt	
0002	USHORT - ifnt	0x0000
0002	IFmt - ifmt	
0002	USHORT - ifmt	0x0000
1 bit	USHORT - fLocked	0x1
1 bit	USHORT - fHidden	0x0
1 bit	USHORT - fStyle	0x1
1 bit	USHORT - f123Prefix	0x0
12 bits	USHORT - ixfParent	0xFFF
0003	StyleXF - Data	
3 bits	BYTE - alc	0x0
1 bit	BYTE - fWrap	0x0
3 bits	BYTE - alcV	0x2
1 bit	BYTE - fJustLast	0x0
0001	XFPropTextRotation - trot	
0001	BYTE - trot	0x00
4 bits	BYTE - cIndent	0x0
1 bit	BYTE - fShrinkToFit	0x0
1 bit	BYTE - reserved1	0x0
2 bits	BYTE - iReadOrder	0x0
0001	BYTE - unused	0x00
4 bits	USHORT - dgLeft	0x0
4 bits	USHORT - dgRight	0x0

Size	Structure	Value
4 bits	USHORT - dgTop	0x0
4 bits	USHORT - dgBottom	0x0
7 bits	USHORT - icvLeft	0x00
7 bits	USHORT - icvRight	0x00
2 bits	USHORT - grbitDiag	0x0
7 bits	ULONG - icvTop	0x00
7 bits	ULONG - icvBottom	0x00
7 bits	ULONG - icvDiag	0x00
4 bits	ULONG - dgDiag	0x0
1 bit	ULONG - reserved2	0x0
6 bits	ULONG - fls	0x00
7 bits	USHORT - icvFore	0x40
7 bits	USHORT - icvBack	0x41
2 bits	USHORT - reserved3	0x0

Figure 99: Structure of Xf

ifnt: A FontIndex that specifies a [Font](#) record.

ifnt.ifnt: 0x0000 specifies that the default **font** is used.

ifmt: Specifies the identifier of a **number format**.

ifmt.ifmt: 0x0000 specifies that general (automatic) formatting is applied for the cell.

fLocked: 0x1 specifies that this cell has **locked protection**. Because this workbook example has no [Protect](#) record, this setting does not apply.

fHidden: 0x0 specifies that this cell is not **hidden**.

fStyle: 0x1 specifies that this record specifies a [cell style XF](#).

f123Prefix: 0x0 specifies that prefix characters are not present in the cell.

ixfParent: 0xFFF specifies that there is no inheritance from a cell style XF.

Data: This structure specifies formatting properties for a [cell style](#).

Data.alc: 0x0 specifies that **horizontal alignment** for the cell is **general alignment**.

Data.fWrap: 0x0 specifies that cell text is not wrapped.

Data.alcV: 0x2 specifies that **vertical alignment** for the cell is bottom alignment.

Data.fJustLast: 0x0 specifies that the cell text is not justified.

Data.trot: This structure specifies rotation for the cell text.

Data.trot.trot: 0x00 specifies zero degrees of rotation.

Data.cIndent: 0x0 specifies that the text indent level is zero.

Data.fShrinkToFit: 0x0 specifies that text is not **shrink to fit**.

Data.iReadOrder: 0x0 specifies that context **reading order** is set.

Data.dgLeft: 0x0 specifies that there is no **logical left** border.

Data.dgRight: 0x0 specifies that there is no **logical right** border.

Data.dgTop: 0x0 specifies that there is no top border.

Data.dgBottom: 0x0 specifies that there is no bottom border.

Data.icvLeft: 0x00 specifies that the logical left border color has not been set.

Data.icvRight: 0x00 specifies that the logical right border color has not been set.

Data.grbitDiag: 0x0 specifies that there is no diagonal border.

Data.icvTop: 0x00 specifies that the top border color has not been set.

Data.icvBottom: 0x00 specifies that the bottom border color has not been set.

Data.icvDiag: 0x00 specifies that the diagonal border color has not been set.

Data.dgDiag: 0x0 specifies the line style for the diagonal border is set to no border.

Data.fls: 0x00 specifies that there is no **fill pattern**.

Data.icvFore: 0x40 specifies that the fill pattern uses the default **foreground color** which is the window text color.

Data.icvBack: 0x41 specifies that fill pattern uses the default **background color** which is the default background color for a cell.

The 20 XF records following this record, and before the next [Style](#) record, are omitted for brevity.

3.9.12 Workbook: Style

This [Style](#) record specifies a [cell style](#) and is the first of six Style records in the **workbook** example .

Size	Structure	Value
0004	Style - Style	
12 bits	USHORT - ixfe	0x010
3 bits	USHORT - unused	0x0
1 bit	USHORT - fBuiltIn	0x1
0002	BuiltInStyle - builtInData	
0001	BYTE - istyBuiltIn	0x03
0001	BYTE - iLevel	0xFF

Figure 100: Structure of Style

Fields in this record that are ignored are omitted for brevity.

ixfe: 0x010 specifies the index to the 16th [XF](#) record for which these properties apply; this XF record is omitted from this workbook example for brevity.

fBuiltIn: 0x0001 specifies that this cell uses the built-in cell style.

builtInData: Specifies an optional built-in cell style.

builtInData.istyBuiltIn: 0x03 specifies that the comma cell style is applied.

The records following this record, and before the next [BoundSheet8](#) record, are omitted for brevity.

3.9.13 Workbook: BoundSheet8 1

This [BoundSheet8](#) record specifies basic information about the first **sheet** in the **workbook** example, including the sheet name, **hidden** state, and type of sheet.

Size	Structure	Value
000E	BoundSheet8 - BoundSheet8	
0004	FilePointer - lbPlyPos	0x000005CA
2 bits	USHORT - hsState	0x0
6 bits	USHORT - unused	0x00
8 bits	USHORT - dt	0x00
0008	ShortXLUnicodeString - stName	Sheet1

Figure 101: Structure of BoundSheet8

lbPlyPos: 0x000005CA specifies the stream position of the start of the [BOF](#) record for the sheet associated with this BoundSheet8 record. This stream position is the start of the binary record, which begins with the two-byte record type and two-byte record size information. See the [record](#) overview for more details. The [worksheet](#) substream for this sheet is shown later in this workbook example.

hsState: 0x0 specifies that the sheet is **visible**.

dt: 0x00 specifies that the sheet type is a **Worksheet**.

stName: "Sheet1" specifies the case-insensitive name of the sheet.

3.9.14 Workbook: BoundSheet8 2

This record is the same as the previous [BoundSheet8](#) record example and specifies basic information about the second **sheet** in the **workbook** example. The fields that contain the same values as the previous record are omitted for brevity.

Size	Structure	Value
000E	BoundSheet8 - BoundSheet8	
0004	FilePointer - lbPlyPos	0x00000785
2 bits	USHORT - hsState	0x0
6 bits	USHORT - unused	0x00

Size	Structure	Value
8 bits	USHORT - dt	0x00
0008	ShortXLUnicodeString - stName	Sheet2

Figure 102: Structure of BoundSheet8

IbPlyPos: 0x00000785 specifies the stream position of the start of the [BOF](#) record for the sheet associated with this BoundSheet8 record. The [worksheet](#) substream for this sheet is omitted for brevity from the workbook example.

stName: "Sheet2" specifies the unique name of the sheet, which is not case sensitive.

3.9.15 Workbook: BoundSheet8 3

This record is the same as the first [BoundSheet8](#) record example and specifies basic information about the third **sheet** in the **workbook** example. The fields that contain the same values as the first BoundSheet8 record are omitted for brevity.

Size	Structure	Value
000E	BoundSheet8 - BoundSheet8	
0004	FilePointer - IbPlyPos	0x0000088C
2 bits	USHORT - hsState	0x0
6 bits	USHORT - unused	0x00
8 bits	USHORT - dt	0x00
0008	ShortXLUnicodeString - stName	Sheet3

Figure 103: Structure of BoundSheet8

IbPlyPos: 0x0000088C specifies the stream position of the start of the [BOF](#) record for the sheet associated with this BoundSheet8 record. The [worksheet](#) substream for this sheet is omitted for brevity from the workbook example.

stName: "Sheet3" specifies the name of the sheet, which is not case sensitive.

3.9.16 Workbook: Country

This [Country](#) record specifies the **locale** information for a **workbook**.

Size	Structure	Value
0004	Country - Country	
0002	USHORT - iCountryDef	0x0001
0002	USHORT - iCountryWinIni	0x0001

Figure 104: Structure of Country

iCountryDef: 0x0001 specifies that the locale for the workbook is the United States.

iCountryWinIni: 0x0001 specifies that the system **regional setting** is United States.

3.9.17 Workbook: RecalcId

This [RecalcId](#) record specifies the recalculation engine identifier of the recalculation engine that last performed a recalculation.

Size	Structure	Value
0008	RecalcId - RecalcID	
0002	USHORT - rt	0x01C1
0002	USHORT - reserved	0x0000
0004	DWORD - dwBuild	0x0001BE22

Figure 105: Structure of RecalcID

rt: 0x01C1 specifies that the record identifier for this record is 449.

dwBuild: 0x0001BE22 specifies the recalculation engine identifier of the recalculation engine that performed the last recalculation, which is 114210.

3.9.18 Workbook: SST

This [SST](#) record specifies string constants.

Size	Structure	Value
001B	SST - Sst	
0004	LONG - cstTotal	0x00000002
0004	LONG - cstUnique	0x00000002
0013	XLUUnicodeRichExtendedString[] - rgb	
0009	XLUUnicodeRichExtendedString - rgb[0]	Number
000A	XLUUnicodeRichExtendedString - rgb[1]	Formula

Figure 106: Structure of Sst

Fields in this record that are ignored because they are optional are omitted for brevity.

cstTotal: 0x00000002 specifies that there are two references in the **workbook** to the strings in the shared string table.

cstUnique: 0x00000002 specifies that there are two unique strings in the shared string table.

rgb: Specifies an array of **Unicode** strings.

rgb.rgb[0]: "Number" is the first string in the shared string table.

rgb.rgb[1]: "Formula" is the second string in the shared string table.

3.9.19 Workbook: ExtSST

This [ExtSST](#) record specifies the location of strings within the shared string table, specified in the previous [SST](#) record.

Size	Structure	Value
000A	ExtSST - ExtSst	
0002	USHORT - dsst	0x0008
0008	ISSTInf[] - rgISSTInf	
0008	ISSTInf - rgISSTInf[0]	
0004	FilePointer - ib	0x0000058C
0002	UINT - cbOffset	0x000C
0002	reserved - reserved	0x0000

Figure 107: Structure of ExtSst

dsst: 0x0008 specifies the default value for this field as specified by the formula in the ExtSST record.

rgISSTInf: Specifies the location of a set of strings within the SST record.

rgISSTInf.rgISSTInf[0].ib: 0x0000058C specifies that the FilePointer as specified in [\[MS-OSHARED\]](#) section 2.2.1.5 that specifies the zero-based offset into the [Workbook](#) stream is 1420.

rgISSTInf.rgISSTInf[0].cbOffset: 0x000C specifies that the zero-based offset into the SST record is 12.

3.9.20 Workbook: BookExt

This [BookExt](#) record specifies properties of the **workbook**.

Size	Structure	Value
0015	BookExt - BookExt	
000C	FrtHeader - FrtHeader	
0002	USHORT - rt	0x0863
0002	FrtFlags - grbitFrt	
1 bit	USHORT - fFrtRef	0x0
1 bit	USHORT - fFrtAlert	0x0
14 bits	USHORT - reserved	0x0000
0008	reserved - reserved	0x0000000000000000
0004	DWORD - cb	0x00000015
1 bit	DWORD - fDontAutoRecover	0x0
1 bit	DWORD - fHidePivotList	0x0
1 bit	DWORD - fFilterPrivacy	0x0
1 bit	DWORD - fEmbedFactoids	0x0
2 bits	DWORD - mdFactoidDisplay	0x0

Size	Structure	Value
1 bit	DWORD - fSavedDuringRecovery	0x0
1 bit	DWORD - fCreatedViaMinimalSave	0x0
1 bit	DWORD - fOpenedViaDataRecovery	0x0
1 bit	DWORD - fOpenedViaSafeLoad	0x0
22 bits	DWORD - reserved	0x000000
0001	BookExt_Conditional11 - grbit1	
1 bit	BYTE - fBuggedUserAboutSolution	0x0
1 bit	BYTE - fShowInkAnnotation	0x1
6 bits	BYTE - unused	0x00

Figure 108: Structure of BookExt

Fields in this record that are ignored because they have zero values are omitted for brevity.

FrtHeader: This structure specifies a [future record](#) header.

FrtHeader.rt: 0x0863 is the required value for this field and specifies that this record is contained in a BookExt record.

FrtHeader.grbitFrt: This structure specifies flags used in the future record header.

FrtHeader.grbitFrt.fFrtRef: 0x0000 specifies that this **FrtHeader** does not specify a **range of cells**.

FrtHeader.grbitFrt.fFrtAlert: 0x0000 specifies that the user is not alerted of possible problems when saving this file without having recognized this record.

cb: 0x00000015 specifies that the size of the record is 21 bytes.

fDontAutoRecover: 0x0 specifies that **AutoRecover** is enabled for the workbook.

fHidePivotList: 0x0 specifies that the [PivotTable](#) field list is not **hidden** for this workbook.

fFilterPrivacy: 0x0 specifies that personal information is not removed from the workbook on save.

fEmbedFactoids: 0x0 specifies that **smart tags** are not embedded in this workbook on save.

mdFactoidDisplay: 0x0 specifies that the workbook displays smart tags as **smart tag actions buttons** and **smart tag indicators**.

fSavedDuringRecovery: 0x0 specifies that the workbook was not saved during AutoRecover.

fCreatedViaMinimalSave: 0x0 specifies the workbook was not created by a **minimal save** during **data recovery**.

fOpenedViaDataRecovery: 0x0 specifies that the workbook was not opened as a result of data recovery.

fOpenedViaSafeLoad: 0x0 specifies that the workbook was not opened in **safe load** mode.

grbit1: Specifies additional workbook information.

grbit1.fBuggedUserAboutSolution: 0x0 specifies that no warning is requested before loading a **manifest** that is a **smart document**.

grbit1.fShowInkAnnotation: 0x1 specifies that **ink comments** for the workbook are not displayed.

3.9.21 Workbook: EOF 1

This [EOF](#) record specifies the end of a collection of records as defined by [Globals Substream ABNF](#).

Size	Structure
0000	EOF - EOF

Figure 109: Structure of EOF

3.9.22 Workbook: BOF 2

This [BOF](#) record specifies the beginning of the [worksheet](#) substream and specifies information about "Sheet1".

Size	Structure	Value
0014	BOF - BOF	
0002	USHORT - vers	0x0600
0002	USHORT - dt	0x0010
0002	USHORT - rupBuild	0x2013
0002	USHORT - rupYear	0x07CD
1 bit	DWORD - fWin	0x1
1 bit	DWORD - fRisc	0x0
1 bit	DWORD - fBeta	0x0
1 bit	DWORD - fWinAny	0x0
1 bit	DWORD - fMacAny	0x0
1 bit	DWORD - fBetaAny	0x0
2 bits	DWORD - unused1	0x3
1 bit	DWORD - fRiscAny	0x0
1 bit	DWORD - fOOM	0x0
1 bit	DWORD - fGIJmp	0x0
2 bits	DWORD - unused2	0x0
1 bit	DWORD - fFontLimit	0x0
4 bits	DWORD - verXLHigh	0x3
1 bit	DWORD - unused3	0x0
13 bits	DWORD - reserved1	0x0000
8 bits	DWORD - verLowestBiff	0x06
4 bits	DWORD - verLastXLSaved	0x3

Size	Structure	Value
20 bits	DWORD - reserved2	0x00000

Figure 110: Structure of BOF

vers: 0x0600 specifies that the file uses **BIFF** version 6.

dt: 0x0010 specifies that the records following this BOF record are part of the worksheet substream.

rupBuild: 0x2013 specifies that the version of the build is 8211.

rupYear: 0x07CD specifies that 1997 was the year when the file format version was first created.

fWin: 0x1 specifies that the file was last edited on a Windows platform.

fRisc: 0x0 specifies that the file was not last edited on a RISC platform.

fBeta: 0x0 specifies that the file was not last edited by a **beta** version of the application.

fWinAny: 0x0 specifies that the file has not been subsequently saved.

fMacAny: 0x0 specifies that the file has never been edited on a Macintosh platform.

fBetaAny: 0x0 specifies that the file has never edited on a beta version of the application.

fRiscAny: 0x0 specifies that the file has never been edited on a RISC platform.

fOOM: 0x0 specifies that the file never had an **out-of-memory** failure.

fGIJump: 0x0 specifies that this file has never had an out-of-memory failure during rendering.

fFontLimit: 0x0 specifies that the file has never reached the 255 **font** limit.

verXLHigh: 0x3 specifies that the file was not edited in any applications after Office Excel 2003.

verLowestBiff: 0x06 specifies that the file is saved in BIFF version 6.

verLastXLSaved: 0x3 specifies that the file was last saved on Office Excel 2003.

3.9.23 Workbook: Index

The next record is an [Index](#) record that specifies row information and the file locations for all [DBCCell](#) records corresponding to each row block in the **sheet**. This record, combined with the DBCCell records, is used to optimize the [lookup of cells](#) in a [cell table](#).

Size	Structure	Value
0014	Index - Index	
0004	ULONG - reserved	0x00000000
0004	RwLongU - rwMic	
0004	ULONG - rw	0x00000003
0004	ULONG - rwMac	0x00000007
0004	FilePointer - ibXF	0x00000686
0004	RgibRw - rgibRw	

Size	Structure	Value
0004	FilePointer - rgibRw[0]	0x0000073E

Figure 111: Structure of Index

rwMic: Specifies the first row that has a cell with data.

rwMic.rw: 0x00000003 specifies that row 4 is the first row with data or formatting.

rwMac: 0x00000007 specifies that row 7 is the last row with data or formatting. This field value specifies the row after the last row that has data or formatting.

ibXF: 0x00000686 specifies a FilePointer as specified in [\[MS-OSHARED\]](#) section 2.2.1.5 that specifies the file position of the [DefColWidth](#) record in this sheet.

rgibRw.rgibRw[0]: 0x0000073E specifies the file position of the DBCell record. This stream position is the start of the binary record, which begins with the two-byte record type and two-byte record size information. See the [record](#) overview for more details.

The records following this record, and before the next [DefaultRowHeight](#) record, are omitted for brevity.

3.9.24 Workbook: DefaultRowHeight

The next record is a [DefaultRowHeight](#) record that specifies the height of all empty rows in the current **sheet**.

Size	Structure	Value
0004	DefaultRowHeight - DefaultRowHeight	
1 bit	USHORT - fUnsynced	0x0
1 bit	USHORT - fDyZero	0x0
1 bit	USHORT - fExAsc	0x0
1 bit	USHORT - fExDsc	0x0
12 bits	USHORT - reserved	0x000
0002	SHORT - miyRw	0x00FF

Figure 112: Structure of DefaultRowHeight

fUnsynced: 0x0 specifies that default settings for the row height have not changed.

fDyZero: 0x0 specifies that empty rows do not have a height of zero.

fExAsc: 0x0 specifies that empty rows do not have a thick **border style** applied to the top **border**.

fExDsc: 0x0 specifies that empty rows do not have a thick border style applied to the bottom border.

miyRw: 0x00FF specifies 255 **twips** as the default row height for empty rows.

3.9.25 Workbook: WsBool

The next record is a [WsBool](#) record that specifies information about a **sheet**.

Size	Structure	Value
0002	WsBool - WsBool	
1 bit	USHORT - fShowAutoBreaks	0x1
3 bits	USHORT - reserved1	0x0
1 bit	USHORT - fDialog	0x0
1 bit	USHORT - fApplyStyles	0x0
1 bit	USHORT - fRowSumsBelow	0x1
1 bit	USHORT - fColSumsRight	0x1
1 bit	USHORT - fFitToPage	0x0
1 bit	USHORT - reserved2	0x0
2 bits	USHORT - unused	0x1
1 bit	USHORT - fSyncHoriz	0x0
1 bit	USHORT - fSyncVert	0x0
1 bit	USHORT - fAltExprEval	0x0
1 bit	USHORT - fAltFormulaEntry	0x0

Figure 113: Structure of WsBool

fShowAutoBreaks: 0x0001 specifies that **page breaks** inserted automatically on the sheet are **visible**.

fDialog: 0x0000 specifies that the sheet is not a **dialog sheet**.

fApplyStyles: 0x0000 specifies not to apply styles in an **outline** when an outline is applied.

fRowSumsBelow: 0x0001 specifies that summary rows appear below an outline's detail rows.

fColSumsRight: 0x0001 specifies that summary columns appear on the left if the sheet is displayed **left-to-right** or appear on the right if the sheet is displayed **right-to-left**.

fFitToPage: 0x0000 specifies that printable contents do not have to fit to a single page when the sheet is printed.

fSyncHoriz: 0x0000 specifies that horizontal scrolling is not synchronized across multiple windows displaying this sheet.

fSyncVert: 0x0000 specifies that vertical scrolling is not synchronized across multiple windows displaying this sheet.

fAltExprEval: 0x0000 specifies that the sheet does not use **transition formula evaluation**.

fAltFormulaEntry: 0x0000 specifies that the sheet does not use **transition formula entry**.

The records following this record, and before the next [Setup](#) record, are omitted for brevity.

3.9.26 Workbook: Setup

The next record is a [Setup](#) record that specifies the page-format settings used to print the current **sheet**.

Size	Structure	Value
0022	Setup - Setup	
0002	USHORT - iPaperSize	0x0000
0002	USHORT - iScale	0x00FF
0002	SHORT - iPageStart	0x0001
0002	USHORT - iFitWidth	0x0001
0002	USHORT - iFitHeight	0x0001
1 bit	BYTE - fLeftToRight	0x0
1 bit	BYTE - fPortrait	0x0
1 bit	BYTE - fNoPls	0x1
1 bit	BYTE - fNoColor	0x0
1 bit	BYTE - fDraft	0x0
1 bit	BYTE - fNotes	0x0
1 bit	BYTE - fNoOrient	0x0
1 bit	BYTE - fUsePage	0x0
1 bit	BYTE - unused1	0x0
1 bit	BYTE - fEndNotes	0x0
2 bits	BYTE - iErrors	0x0
4 bits	BYTE - unused2	0x0
0002	USHORT - iRes	0x0015
0002	USHORT - iVRes	0x0000
0008	Double - numHdr	0x3FE0000000000000
0008	Double - numFtr	0x3FE0000000000000
0002	USHORT - iCopies	0x3030

Figure 114: Structure of Setup

Fields in this record that are ignored because **fNoPls** is 1 are omitted for brevity.

iFitWidth: 0x0001 specifies that the sheet width is fit to one page.

iFitHeight: 0x0001 specifies that the sheet height is fit to one page.

fLeftToRight: 0x00 specifies that the pages are printed in columns.

fNoPls: 0x01 specifies that fields **iPaperSize**, **iScale**, **iRes**, **iVRes**, **iCopies**, **fNoOrient**, and **fPortrait** data are undefined and ignored.

fNoColor: 0x00 specifies that the workbook is not printed in black and white.

fDraft: 0x00 specifies that the workbook is not printed using draft quality.

fNotes: 0x00 specifies that cell notes are not printed. The **fEndNotes** field is not included in this example for brevity.

fUsePage: 0x00 specifies that no custom starting page number is being used to print. The **iPageStart** field is not included in this example for brevity.

iErrors: 0x00 specifies that errors in the **cell** data are printed as displayed on the sheet.

numHdr: 0x3FE0000000000000 specifies that the header margin is .5 inches.

numFtr: 0x3FE0000000000000 specifies that the footer margin is .5 inches.

3.9.27 Workbook: DefColWidth

The next record is a [DefColWidth](#) record that specifies the default column width of a **sheet**.

Size	Structure	Value
0002	DefColWidth - DefColWidth	
0002	USHORT - cchdefColWidth	0x0008

Figure 115: Structure of DefColWidth

cchdefColWidth: 0x0008 specifies that the default width of the columns in the sheet is 8 characters.

3.9.28 Workbook: Dimensions

The next record is a [Dimensions](#) record that specifies the minimum and maximum bounds of all **cells** on the sheet that contain data or formatting.

Size	Structure	Value
000E	Dimensions - Dimensions	
0004	RwLongU - rwMic	
0004	ULONG - rw	0x00000003
0004	ULONG - rwMac	0x00000007
0002	ColU - colMic	
0002	USHORT - col	0x0001
0002	USHORT - colMac	0x0002
0002	USHORT - reserved	0x0000

Figure 116: Structure of Dimensions

rwMic: Specifies the first row in the **sheet** that contains a cell with data or formatting.

rwMic.rw: 0x00000003 specifies that the first row with data or formatting is row 4.

rwMac: 0x00000007 specifies that that row 7 is the last row with data or formatting. This field value specifies the row after the last row that has data or formatting.

colMic: Specifies the first column in the sheet that contains a cell with data or formatting.

colMic.col: 0x0001 specifies that column B is the first column with data or formatting.

colMac: 0x0002 specifies that column B is the last column with data or formatting. This field value specifies the column after the last column that has data or formatting.

3.9.29 Workbook: Row 1

This record is a [Row](#) record that specifies a single row on a [sheet](#).

Size	Structure	Value
0010	Row - Row	
0002	Rw - rw	
0002	USHORT - rw	0x0003
0002	USHORT - colMic	0x0001
0002	USHORT - colMac	0x0002
0002	USHORT - miyRw	0x00FF
0002	SHORT - reserved1	0x0000
0002	SHORT - unused1	0x0000
3 bits	BYTE - iOutLevel	0x0
1 bit	BYTE - reserved2	0x0
1 bit	BYTE - fCollapsed	0x0
1 bit	BYTE - fDyZero	0x0
1 bit	BYTE - fUnsynced	0x0
1 bit	BYTE - fGhostDirty	0x0
0001	BYTE - reserved3	0x01
12 bits	SHORT - ixfe_val	0x00F
1 bit	SHORT - fExAsc	0x0
1 bit	SHORT - fExDes	0x0
1 bit	SHORT - fPhonetic	0x0
1 bit	SHORT - unused2	0x0

Figure 117: Structure of Row

rw: Specifies the row index.

rw.rw: 0x0003 specifies that this record is for row 4.

colMic: 0x0001 specifies that column B is the first column that contains a [cell](#) populated with data or formatting.

colMac: 0x0002 specifies that column B is the last column that contains a cell populated with data or formatting.

miyRw: 0x00FF specifies the row height as 255 **twips**.

iOutLevel: 0x00 specifies the row has no **outline level**.

fDyZero: 0x00 specifies that the row is not **hidden**.

fUnsynced: 0x00 specifies that the row height has not been manually set.

fGhostDirty: 0x00 specifies that the row has not been formatted.

ixfe_val: 0x000F specifies that this row uses the default formatting.

fExAsc: 0x0000 specifies that no cell in the row has a thick top **border**.

fExDes: 0x0000 specifies that no cell in the row has a thick bottom border.

fPhonetic: 0x0000 specifies that **phonetic guide** is not enabled for any cell in this row.

3.9.30 Workbook: Row 2

This record is another [Row](#) record that specifies a single row on a **sheet**.

Size	Structure	Value
0010	Row - Row	
0002	Rw - rw	
0002	USHORT - rw	0x0004
0002	USHORT - colMic	0x0001
0002	USHORT - colMac	0x0002
0002	USHORT - miyRw	0x00FF
0002	SHORT - reserved1	0x0000
0002	SHORT - unused1	0x0000
3 bits	BYTE - iOutLevel	0x0
1 bit	BYTE - reserved2	0x0
1 bit	BYTE - fCollapsed	0x0
1 bit	BYTE - fDyZero	0x0
1 bit	BYTE - fUnsynced	0x0
1 bit	BYTE - fGhostDirty	0x0
0001	BYTE - reserved3	0x01
12 bits	SHORT - ixfe_val	0x00F
1 bit	SHORT - fExAsc	0x0
1 bit	SHORT - fExDes	0x0
1 bit	SHORT - fPhonetic	0x0
1 bit	SHORT - unused2	0x0

Figure 118: Structure of Row

Fields in this record that are explained in previous records in this example are omitted for brevity.

rw.rw: 0x0004 specifies that this record is for row 5.

3.9.31 Workbook: Row 3

This record is another [Row](#) record that specifies a single row on a **sheet**.

Size	Structure	Value
0010	Row - Row	
0002	Rw - rw	
0002	USHORT - rw	0x0005
0002	USHORT - colMic	0x0001
0002	USHORT - colMac	0x0002
0002	USHORT - miyRw	0x00FF
0002	SHORT - reserved1	0x0000
0002	SHORT - unused1	0x0000
3 bits	BYTE - iOutLevel	0x0
1 bit	BYTE - reserved2	0x0
1 bit	BYTE - fCollapsed	0x0
1 bit	BYTE - fDyZero	0x0
1 bit	BYTE - fUnsynced	0x0
1 bit	BYTE - fGhostDirty	0x0
0001	BYTE - reserved3	0x01
12 bits	SHORT - ixfe_val	0x00F
1 bit	SHORT - fExAsc	0x0
1 bit	SHORT - fExDes	0x0
1 bit	SHORT - fPhonetic	0x0
1 bit	SHORT - unused2	0x0

Figure 119: Structure of Row

Fields in this record that are explained in previous records in this example are omitted for brevity.

rw.rw: 0x0005 specifies that this record is for row 6.

3.9.32 Workbook: Row 4

This record is another [Row](#) record that specifies a single row on a **sheet**.

Size	Structure	Value
0010	Row - Row	
0002	Rw - rw	
0002	USHORT - rw	0x0006
0002	USHORT - colMic	0x0001
0002	USHORT - colMac	0x0002
0002	USHORT - miyRw	0x00FF
0002	SHORT - reserved1	0x0000
0002	SHORT - unused1	0x0000
3 bits	BYTE - iOutLevel	0x0
1 bit	BYTE - reserved2	0x0
1 bit	BYTE - fCollapsed	0x0
1 bit	BYTE - fDyZero	0x0
1 bit	BYTE - fUnsynced	0x0
1 bit	BYTE - fGhostDirty	0x0
0001	BYTE - reserved3	0x01
12 bits	SHORT - ixfe_val	0x00F
1 bit	SHORT - fExAsc	0x0
1 bit	SHORT - fExDes	0x0
1 bit	SHORT - fPhonetic	0x0
1 bit	SHORT - unused2	0x0

Figure 120: Structure of Row

Fields in this record that are explained in previous records in this example are omitted for brevity.

rw.rw: 0x0006 specifies that this record is for row 7.

3.9.33 Workbook: LabelSst 1

This record is a [LabelSst](#) record that specifies a string that is stored in a **cell** as a reference to the shared string table.

Size	Structure	Value
000A	LabelSst - LabelSst	
0006	Cell - cell	
0002	Rw - rw	
0002	USHORT - rw	0x0003

Size	Structure	Value
0002	Col - col	
0002	USHORT - col	0x0001
0002	IXFCell - ixfe	
0002	USHORT - ixfe	0x000F
0004	ULONG - isst	0x00000000

Figure 121: Structure of LabelSst

cell: Specifies a cell in a **sheet**.

cell.rw: Specifies a row in the sheet.

cell.rw.rw: 0x0003 specifies row 4.

cell.col: Specifies a column in the sheet.

cell.col.col: 0x0001 specifies column B.

cell.ixfe: Specifies the index of a [cell XF](#) record that describes the formatting properties for the cell.

cell.ixfe.ixfe: 0x000F specifies that this cell uses the default cell format.

isst: 0x00000000 specifies that 0 is the zero-based index into the **rgb** field of [SST](#), which specifies that the text for this cell is "Number".

3.9.34 Workbook: RK

This record is an [RK](#) record that specifies the numeric data contained in a single **cell**.

Size	Structure	Value
000A	RK - Rk	
0002	Rw - rw	
0002	USHORT - rw	0x0004
0002	Col - col	
0002	USHORT - col	0x0001
0006	RkRec - rkrec	
0002	IXFCell - ixfe	
0002	USHORT - ixfe	0x000F
0004	RkNumber - RK	
1 bit	ULONG - FX100	0x0
1 bit	ULONG - FInt	0x0
30 bits	ULONG - num	0x0FFC0000

Figure 122: Structure of Rk

rw: Specifies a row in the **sheet**.

rw.rw: 0x0004 specifies row 5.

col: Specifies a column in the sheet.

col.col: 0x0001 specifies column B.

rkrec: Specifies the numeric data for this cell.

rkrec.ixfe: Specifies the index of a **cell XF** record that describes the formatting properties for the cell.

rkrec.ixfe.ixfe: 0x000F specifies that this cell uses the default cell format.

rkrec.RK: An RkNumber that specifies a numeric value.

rkrec.RK.FX100: 0x0 specifies that the value in the **rkrec.RK.num** field was not multiplied by 100 when it was saved.

rkrec.RK.FInt: 0x0 specifies that the value in the **rkrec.RK.num** field is the 30 most significant bits of a 64-bit binary floating-point number as defined in [\[IEEE754\]](#).

rkrec.RK.num: 0x0FFC0000 specifies the 30 most significant bits of a 64-bit binary floating-point number as defined in [\[IEEE754\]](#). The remaining 34 bits are 0, which evaluates to a numeric value of 1.

3.9.35 Workbook: LabelSst 2

This record is a [LabelSst](#) record that specifies a string that is stored in a **cell** as a reference to the shared string table.

Size	Structure	Value
000A	LabelSst - LabelSst	
0006	Cell - cell	
0002	Rw - rw	
0002	USHORT - rw	0x0005
0002	Col - col	
0002	USHORT - col	0x0001
0002	IXFCell - ixfe	
0002	USHORT - ixfe	0x000F
0004	ULONG - isst	0x00000001

Figure 123: Structure of LabelSst

Fields in this record that are explained in previous records in this example are omitted for brevity.

cell.rw.rw: 0x0005 specifies row 6.

isst: 0x00000001 specifies that 1 is the zero-based index into the **rgb** field of [SST](#), which specifies that the text for this cell is "Formula".

3.9.36 Workbook: Formula

This record is a [Formula](#) record that specifies a formula (section [2.2.2](#)) for a **cell**.

Size	Structure	Value
0022	Formula - Formula	
0006	Cell - cell	
0002	Rw - rw	
0002	USHORT - rw	0x0006
0002	Col - col	
0002	USHORT - col	0x0001
0002	IXFCell - ixfe	
0002	USHORT - ixfe	0x000F
0008	FormulaValue - val	0x3FF6A09E667F3BCD
1 bit	USHORT - fAlwaysCalc	0x0
1 bit	USHORT - reserved1	0x0
1 bit	USHORT - fFill	0x0
1 bit	USHORT - fShrFmla	0x0
1 bit	USHORT - reserved2	0x0
1 bit	USHORT - fClearErrors	0x0
10 bits	USHORT - reserved3	0x000
0004	DWORD - chn	0xFCFC000C
000E	CellParsedFormula - formula	
0002	WORD - cce	0x000C
000C	Rgce - rgce	
0005	Ptg - Ptg[0]	
0005	PtgRef - PtgRef	
5 bits	BYTE - ptg	0x04
2 bits	BYTE - type	0x2
1 bit	BYTE - reserved	0x0
0004	RgceLoc - loc	
0002	RwU - row	
0002	USHORT - rw	0x0004
0002	ColRelU - column	

Size	Structure	Value
14 bits	USHORT - col	0x0001
1 bit	USHORT - colRelative	0x1
1 bit	USHORT - rowRelative	0x1
0003	Ptg - Ptg[1]	
0003	PtgInt - PtgInt	
7 bits	BYTE - ptg	0x1E
1 bit	BYTE - reserved0	0x0
0002	WORD - integer	0x0002
0001	Ptg - Ptg[2]	
0001	PtgMul - PtgMul	
7 bits	BYTE - ptg	0x05
1 bit	BYTE - reserved0	0x0
0003	Ptg - Ptg[3]	
0003	PtgFunc - PtgFunc	
5 bits	BYTE - ptg	0x01
2 bits	BYTE - type	0x2
1 bit	BYTE - reserved	0x0
0002	Ftab - iftab	
0002	WORD - iftab	0x0014

Figure 124: Structure of Formula

cell: Specifies a cell on the **sheet**.

cell.rw: Specifies the row of the cell.

cell.rw.rw: 0x0006 specifies row 7.

cell.col: Specifies the column of the cell.

cell.col.col: 0x0001 specifies column B.

cell.ixfe: Specifies the index of a [cell XF](#) record that describes the formatting properties for the cell.

cell.ixfe.ixfe: 0x000F specifies that this cell uses the default cell format.

val: 0x3FF6A09E667F3BCD specifies the floating-point value of 1.4142135623731, which is the value in the cell as a result of the last calculation.

fAlwaysCalc: 0x0 specifies that the formula does not need to be recalculated.

fFill: 0x0 specifies this cell does not have a **fill alignment** or a **center-across-selection alignment**.

fShrFmla: 0x0 specifies that the formula is not part of a shared formula.

fClearErrors: 0x0 specifies that the formula is not excluded from **formula error checking**.

chn: Specifies an application-specific cache. This is optionally used and can be ignored.

formula: Specifies a formula.

formula.cce: 0x000C specifies the length of **rgce** in bytes.

formula.rgce: Specifies the sequence of Ptgs for the formula $\text{SQRT}(B5*2)$.

formula.rgce.Ptg[0]: Specifies a single element of a formula.

formula.rgce.Ptg[0].PtgRef: Specifies a reference to a single cell on the current sheet.

formula.rgce.Ptg[0].PtgRef.ptg: 0x04 specifies that this Ptg is a PtgRef.

formula.rgce.Ptg[0].PtgRef.type: 0x2 specifies that this PtgRef uses a value data type.

formula.rgce.Ptg[0].PtgRef.loc: Specifies the cell referenced by this Ptg.

formula.rgce.Ptg[0].PtgRef.loc.row: Specifies the row of the referenced cell.

formula.rgce.Ptg[0].PtgRef.loc.row.rw: 0x0004 specifies that the referenced cell is in row 5.

formula.rgce.Ptg[0].PtgRef.loc.column: Specifies the column of the referenced cell.

formula.rgce.Ptg[0].PtgRef.loc.column.col: 0x0001 specifies that the referenced cell is in column B.

formula.rgce.Ptg[0].PtgRef.loc.column.colRelative: 0x1 specifies that the column reference is a **relative reference**.

formula.rgce.Ptg[0].PtgRef.loc.column.rowRelative: 0x1 specifies that the row reference is a relative reference.

formula.rgce.Ptg[1]: Specifies a single element of a formula.

formula.rgce.Ptg[1].PtgInt: Specifies an integer value.

formula.rgce.Ptg[1].PtgInt.ptg: 0x1E specifies that this is a PtgInt.

formula.rgce.Ptg[1].PtgInt.integer: 0x0002 specifies that the value is 2.

formula.rgce.Ptg[2]: Specifies a single element of a formula.

formula.rgce.Ptg[2].PtgMul: Specifies a binary-value-operator that multiplies the first and second expressions in a binary-value-expression.

formula.rgce.Ptg[2].PtgMul.ptg: 0x05 specifies that this Ptg is a PtgMul.

formula.rgce.Ptg[3]: Specifies a single element of a formula.

formula.rgce.Ptg[3].PtgFunc: Specifies a mathematical function.

formula.rgce.Ptg[3].PtgFunc.ptg: 0x01 specifies that this is a PtgFunc.

formula.rgce.Ptg[3].PtgFunc.type: 0x2 specifies that this Ptg uses a value data type.

formula.rgce.Ptg[3].PtgFunc.iftab: Specifies the function to be called for this Ptg.

formula.rgce.Ptg[3].PtgFunc.iftab.iftab: 0x0014 specifies that SQRT is the function to be called.

3.9.37 Workbook: DBCell

This record is a [DBCell](#) record that specifies the location of the first row and the first cell record in each row of the current row block in the [workbook stream](#).

Size	Structure	Value
000C	DBCell - DbCell	
0004	ULONG - dbRtrw	0x000000A0
0008	Rgdb - rgdb	
0002	USHORT - rgdb[0]	0x003C
0002	USHORT - rgdb[1]	0x000E
0002	USHORT - rgdb[2]	0x000E
0002	USHORT - rgdb[3]	0x000E

Figure 125: Structure of DbCell

dbRtrw: 0x000000A0 specifies the offset from the file position of this record to the file position of the first row record.

rgdb: Specifies the file offset to the first cell record in each row.

rgdb.rgdb[0]: 0x003C specifies the file offset in bytes to the first record that specifies a [CELL](#) in each row that is a part of this row block. The starting position of this offset is specified relative to the file position of the end of the first [Row](#) record in the row block

rgdb.rgdb[1]: 0x000E specifies the file offset in bytes to the first record that specifies a CELL in each row that is a part of this row block. The offset is specified relative to the file position of the CELL record specified by the previous element in this array.

rgdb.rgdb[2]: 0x000E specifies the file offset in bytes to the first record that specifies a CELL in each row that is a part of this row block. The offset is specified relative to the file position of the CELL record specified by the previous element in this array.

rgdb.rgdb[3]: 0x000E specifies the file offset in bytes to the first record that specifies a CELL in each row that is a part of this row block. The offset is specified relative to the file position of the CELL record specified by the previous element in this array.

3.9.38 Workbook: Window2

This record is a [Window2](#) record that specifies attributes of the window used to display the **sheet**.

Size	Structure	Value
0012	Window2 - Window2	
1 bit	USHORT - fDspFmlaRt	0x0
1 bit	USHORT - fDspGridRt	0x1
1 bit	USHORT - fDspRwColRt	0x1
1 bit	USHORT - fFrozenRt	0x0
1 bit	USHORT - fDspZerosRt	0x1

Size	Structure	Value
1 bit	USHORT - fDefaultHdr	0x1
1 bit	USHORT - fRightToLeft	0x0
1 bit	USHORT - fDspGuts	0x1
1 bit	USHORT - fFrozenNoSplit	0x0
1 bit	USHORT - fSelected	0x1
1 bit	USHORT - fPaged	0x1
1 bit	USHORT - fSLV	0x0
4 bits	USHORT - reserved1	0x0
0002	RwU - rwTop	
0002	USHORT - rw	0x0000
0002	ColU - colLeft	
0002	USHORT - col	0x0000
0002	Icv - icvHdr	
0002	USHORT - icv	0x0040
0002	USHORT - reserved2	0x0000
0002	USHORT - wScaleSLV	0x0000
0002	USHORT - wScaleNormal	0x0000
0002	USHORT - unused	0x0000
0002	USHORT - reserved3	0x0000

Figure 126: Structure of Window2

fDspFmlaRt: 0x0 specifies that this window displays values.

fDspGridRt: 0x1 specifies that this window displays **gridlines**.

fDspRwColRt: 0x1 specifies that this window displays row headings and column headings.

fFrozenRt: 0x0 specifies that the panes in the window are not **frozen**. The **fFrozenNoSplit** field is not included in this example for brevity.

fDspZerosRt: 0x1 specifies that this window displays each **cell** that has a value of zero as a zero.

fDefaultHdr: 0x1 specifies that the gridlines of this window are drawn in the default **foreground color** of the window.

fRightToLeft: 0x0 specifies that the text is displayed **left-to-right**.

fDspGuts: 0x1 specifies that this window displays the **outline state**.

fSelected: 0x1 specifies that the **sheet tab** is **selected**.

fPaged: 0x1 specifies that the sheet is currently being displayed in the window.

fSLV: 0x0 specifies that the sheet is not in **Page Break Preview view**.

rwTop.rw: 0x0000 specifies row 1 as the first visible row on the sheet.

colLeft.col: 0x0000 specifies column 1 as the first visible column on the sheet.

icvHdr.icv: 0x0040 specifies that the gridlines of this window are drawn in the default foreground color of the window.

wScaleSLV: 0x0000 specifies that the **zoom level** in the Page Break Preview view is the default zoom level.

wScaleNormal: 0x0000 specifies that the zoom level in the **Normal view** is the default zoom level.

3.9.39 Workbook: Selection

This record is a [Selection](#) record that specifies the **selected cells** within a **sheet**.

Size	Structure	Value
000F	Selection - Selection	
0001	PaneType - pnn	0x03
0002	RwU - rwAct	
0002	USHORT - rw	0x0007
0002	ColU - colAct	
0002	USHORT - col	0x0001
0002	USHORT - irefAct	0x0000
0002	USHORT - cref	0x0001
0006	SqRefU - rgref	
0006	RefU - rgref[0]	
0002	RwU - rwFirst	
0002	USHORT - rw	0x0007
0002	RwU - rwLast	
0002	USHORT - rw	0x0007
0001	ColByteU - colFirst	
0001	BYTE - col	0x01
0001	ColByteU - colLast	
0001	BYTE - col	0x01

Figure 127: Structure of Selection

pnn: 0x03 specifies that a top left pane is the **active pane**.

rwAct: An RwU that specifies the row number of the **active cell**.

rwAct.rw: 0x0007 specifies that row 8 contains the active cell.

colAct: A ColU that specifies the column number of the active cell.

colAct.col: 0x0001 specifies that column B contains the active cell.

irefAct: 0x0000 specifies an index into the **rgref** array that specifies the **range** of cells that contain the active cell.

cref: 0x0001 specifies that there is 1 range of cells in the **rgref** array of this record.

rgref: An array of RefU that specifies ranges of selected cells in the sheet.

rgref.rgref[0]: Specifies a range of cells on the sheet.

rgref.rgref[0].rwFirst: An RwU that specifies the first row in the range.

rgref.rgref[0].rwFirst.rw: 0x0007 specifies that row 8 is the first row in the range.

rgref.rgref[0].rwLast: Specifies the last row in the range.

rgref.rgref[0].rwLast.rw: 0x0007 specifies that row 8 is the last row in the range.

rgref.rgref[0].colFirst: A ColByteU that specifies the first column in the range.

rgref.rgref[0].colFirst.col: 0x01 specifies that column B is the first column in the range.

rgref.rgref[0].colLast: A ColByteU that specifies the last column in the range.

rgref.rgref[0].colLast.col: 0x01 specifies that column B is the last column in the range.

3.9.40 Workbook: PhoneticInfo

This record is a [PhoneticInfo](#) record that specifies the default format for **phonetic strings** and the **ranges** of **cells** on the **sheet** that have **visible** phonetic strings.

Size	Structure	Value
0006	PhoneticInfo - PhoneticInfo	
0004	Phs - phs	
0002	FontIndex - ifnt	
0002	USHORT - ifnt	0x0000
2 bits	USHORT - phType	0x3
2 bits	USHORT - alch	0x1
12 bits	USHORT - unused	0x003
0002	SqRef - sqref	
0002	USHORT - cref	0x0000

Figure 128: Structure of PhoneticInfo

phs: A Phs structure that specifies the default format for phonetic string on the sheet.

phs.ifnt: A FontIndex structure that specifies the **font** for the string.

phs.ifnt.ifnt: 0x0000 specifies that the default font is used.

phs.phType: 0x0003 specifies that phonetic string can use any type of characters.

phs.alcH: 0x0001 specifies that left alignment is used in the phonetic string.

sqref: A SqRef structure that specifies the ranges of cells on the sheet that have visible phonetic strings.

sqref.cref: 0x0000 specifies the number of elements in **rgrefs**. The **rgrefs** field is not included in this example for brevity.

3.9.41 Workbook: EOF 2

This record is an [EOF](#) record which specifies the end of a collection of records for this [worksheet](#) substream.

Size	Structure
0000	EOF - EOF

Figure 129: Structure of EOF

The remaining records in this **workbook** example, two Worksheet substreams, are omitted for brevity.

3.10 PivotTable

This example shows a [PivotTable](#) and associated [PivotCache](#) within a **workbook**. The PivotTable uses a range of cells (A1:E45) in the "Source Data" **sheet** as its **data source**. A CustomerName field and ProductName field are added to the [row area](#), a Quantity field to the [data area](#), and an OrderDate field to the [page area](#) of this PivotTable. Two dates are selected in the **filter** for the OrderDate field; the other dates are filtered out from page area. This example addresses important PivotTable records, and those records that are relevant to different parts of the PivotTable from the [Workbook stream](#) and [Pivot Cache Storage stream](#).

The following figure shows a possible implementation of the PivotTable discussed in this example.

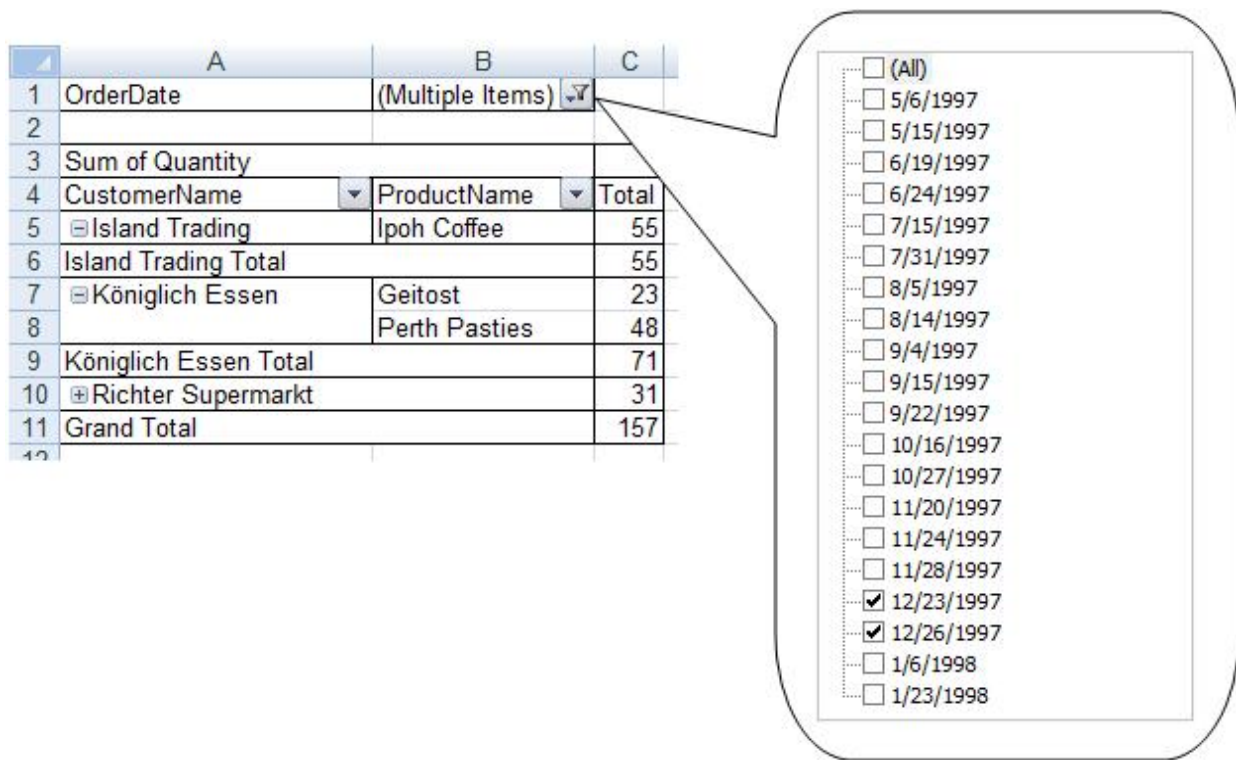

Figure 130: Example PivotTable within a sheet

3.10.1 PivotTable: SXStreamID

The first record, an [SXStreamID](#), specifies the stream in the [PivotCache storage](#) that contains the [PivotCache](#) for this [PivotTable](#).

Size	Structure	Value
0002	SXStreamID - SxStreamID	
0002	USHORT - idstm	0x0001

Figure 131: Structure of SxStreamID

idstm: 0x0001 specifies the identifier of the stream in the PivotCache storage that contains the PivotCache for this PivotTable. The stream identifier is a four-character string representation of the hexadecimal value. In this case the stream identifier is "0001".

3.10.2 PivotTable: SXVS

The next record, an [SXVS](#), specifies that the type of [source data](#) used for this [PivotCache](#) is a **range**.

Size	Structure	Value
0002	SXVS - SXVS	
0002	USHORT - sxvs	0x0001

Figure 132: Structure of SXVS

sxvs: 0x0001 specifies that the source data for this PivotTable is a range. The [DConRef](#) record that follows this record specifies the range.

3.10.3 PivotTable: DConRef

The next record, a [DConRef](#), specifies the **range** in this **workbook** that is the [source data](#) for this [PivotTable](#).

Size	Structure	Value
0016	DConRef - DConRef	
0006	RefU - ref	
0002	RwU - rwFirst	
0002	USHORT - rw	0x0000
0002	RwU - rwLast	
0002	USHORT - rw	0x002C
0001	ColByteU - colFirst	
0001	BYTE - col	0x00
0001	ColByteU - colLast	
0001	BYTE - col	0x04
0002	USHORT - cchFile	0x000C
000D	DConFile - stFile	
000D	XLUnicodeStringNoCch - stFile	Source Data
0001	unused - unused	0x00

Figure 133: Structure of DConRef

ref: A RefU structure that specifies the range of the source data for this PivotTable in the **sheet** specified by **stFile**.

ref.rwFirst: An RwU structure that specifies the first row in the range of the source data for this PivotTable.

ref.rwFirst.rw: 0x0000 specifies that the range of the source data for this PivotTable begins in row 1 of the sheet specified by **stFile**.

ref.rwLast: An RwU structure that specifies the last row in the range of the source data for this PivotTable.

ref.rwLast.rw: 0x002C specifies that the range of the source data for this PivotTable ends in row 45 of the sheet specified by **stFile**.

ref.colFirst: A ColByteU structure that specifies the first column in the range of the source data for this PivotTable.

ref.colFirst.col: 0x00 specifies that the range of the source data for this PivotTable begins in the column A of the sheet specified by **stFile**.

ref.colLast: A ColByteU structure that specifies the last column in the range of the source data for this PivotTable.

ref.colLast.col: 0x04 specifies that the range of the source data for this PivotTable ends in column E of the sheet specified by **stFile**.

chFile: 0x000C specifies that **stFile** is 12 characters in length.

stFile: A DConFile structure that specifies the name of the worksheet that contains the range of the source data for this PivotTable.

stFile.stFile: A string, "Source Data", that specifies the name of the worksheet that contains the range of the source data for this PivotTable.

3.10.4 PivotTable: SXAddl 1

The next record, [SXAddl](#), specifies additional information for this [PivotTable view](#).

Size	Structure	Value
000C	SXAddl SXCCache SXDIId - SXAddl	
0006	SXAddlHdr - hdr	
0004	FrtHeaderOld - frtHeaderOld	
0002	USHORT - rt	0x0864
0002	FrtFlags - grbitFrt	
1 bit	USHORT - fFrtRef	0x0
1 bit	USHORT - fFrtAlert	0x0
14 bits	USHORT - reserved	0x0000
0001	BYTE - sxc	0x03
0001	BYTE - sxd	0x00
0004	ULONG - idCache	0x00000001
0002	USHORT - reserved	0x0000

Figure 134: Structure of SXAddl

hdr: An SXAddlHdr structure that specifies header information for this SXAddl record.

hdr.frtHeaderOld: A structure that specifies a [future record](#) type header.

hdr.frtHeaderOld.rt: 0x0864 specifies the record type identifier for this record.

hdr.frtHeaderOld.grbitFrt: A structure that specifies flags for **hdr.FrtHeaderOld**.

hdr.frtHeaderOld.grbitFrt.fFrtRef: 0x0 specifies that this record does not specify a **range of cells**.

hdr.frtHeaderOld.grbitFrt.fFrtAlert: 0x0 specifies that the application does not alert the user about possible problems if the file is saved without the record being recognized.

hdr.sxc: 0x03 specifies the current [class](#) as an [SxcCache class](#).

hdr.sxd: 0x00 specifies the type of record contained in the **data** field of the containing SXAddl record. This value specifies that the type of this SXAddl record is SXAddl_SXCCache_SXDId.

idCache: 0x00000001 specifies the [PivotCache](#) stream that is associated with this SxcCache class.

3.10.5 PivotTable: SXAddl 2

The next record, [SXAddl](#), specifies additional information for this [PivotTable view](#).

Size	Structure	Value
001C	SXAddl_SXCCache_SXDVer10Info - SXAddl	
0006	SXAddlHdr - hdr	
0004	FrtHeaderOld - frtHeaderOld	
0002	USHORT - rt	0x0864
0002	FrtFlags - grbitFrt	
1 bit	USHORT - fFrtRef	0x0
1 bit	USHORT - fFrtAlert	0x0
14 bits	USHORT - reserved	0x0000
0001	BYTE - sxc	0x03
0001	BYTE - sxd	0x02
0006	reserved - reserved1	0x000000000000
0004	LONG - citmGhostMax	0xFFFFFFFF
0001	BYTE - bVerCacheLastRefresh	0x02
0001	BYTE - bVerCacheRefreshableMin	0x00
0008	DateAsNum - numDateCopy	
0008	Double - dateNum	0x40E355907CBEB8CE
0002	USHORT - reserved2	0x0000

Figure 135: Structure of SXAddl

Fields in this record that are explained in previous record descriptions in this example are omitted for brevity.

hdr: An SXAddlHdr structure that specifies header information for this SXAddl record.

hdr.sxc: 0x03 specifies the current [class](#) as an [SxcCache class](#).

hdr.sxd: 0x02 specifies the type of record contained in the **data** field of the containing SXAddl record. See [class](#) for more information. This value specifies that the type of this SXAddl record is SXAddl_SXCCache_SXDVer10Info.

citmGhostMax: 0xFFFFFFFF specifies that the number of unused [cache items](#) to allow before discarding those that are unused is not determined by the file; instead, the application optimizes the number of unused cache items at run time.

bVerCacheLastRefresh: 0x02 specifies the [data functionality level](#) with which the [PivotCache](#) was last refreshed.

bVerCacheRefreshableMin: 0x00 specifies the lowest data functionality level with which the application is allowed to **refresh** the PivotCache.

numDateCopy: Specifies the date and time when the PivotCache was last refreshed.

numDateCopy.dateNum: 0x40E355907CBEB8CE specifies a DateAsNum structure which indicates that this PivotCache was last refreshed on May 28th, 2008 at 12:21PM.

3.10.6 PivotTable: SXAddI 3

The next record in this example, [SXAddI](#), specifies additional information for this [PivotTable view](#).

Size	Structure	Value
000C	SXAddI_SXCCache_SXDEnd - SXAddI	
0006	SXAddIHdr - hdr	
0004	FrtHeaderOld - frtHeaderOld	
0002	USHORT - rt	0x0864
0002	FrtFlags - grbitFrt	
1 bit	USHORT - fFrtRef	0x0
1 bit	USHORT - fFrtAlert	0x0
14 bits	USHORT - reserved	0x0000
0001	BYTE - sxc	0x03
0001	BYTE - sxd	0xFF
0006	reserved - reserved	0x000000000000

Figure 136: Structure of SXAddI

Fields in this record that are explained in previous record descriptions in this example are omitted for brevity.

hdr: An SXAddIHdr structure that specifies header information for this SXAddI record.

hdr.sxc: 0x03 specifies the current [class](#) as an [SxcCache class](#).

hdr.sxd: 0xFF specifies the type of record contained in the **data** field of the containing SXAddI record. See [class](#) for more information. This value specifies that the type of this SXAddI record is SXAddI_SXCCache_SXDEnd.

3.10.7 PivotTable: SxView

The next record in this example, [SxView](#), specifies the top-level [PivotTable view](#) information for this [PivotTable](#).

Size	Structure	Value
0042	SxView - SxView	

Size	Structure	Value
0008	Ref8U - ref	
0002	RwU - rwFirst	
0002	USHORT - rw	0x0002
0002	RwU - rwLast	
0002	USHORT - rw	0x000A
0002	CoIU - colFirst	
0002	USHORT - col	0x0000
0002	CoIU - colLast	
0002	USHORT - col	0x0002
0002	RwU - rwFirstHead	
0002	USHORT - rw	0x0004
0002	RwU - rwFirstData	
0002	USHORT - rw	0x0004
0002	CoIU - colFirstData	
0002	USHORT - col	0x0002
0002	SHORT - iCache	0x0000
0002	SHORT - reserved	0x0000
0002	SXAxis - sxaxis4Data	
1 bit	USHORT - sxaxisRw	0x1
1 bit	USHORT - sxaxisCol	0x0
1 bit	USHORT - sxaxisPage	0x0
1 bit	USHORT - sxaxisData	0x0
12 bits	USHORT - reserved	0x000
0002	SHORT - ipos4Data	0xFFFF
0002	SHORT - cDim	0x0005
0002	SHORT - cDimRw	0x0002
0002	SHORT - cDimCol	0x0000
0002	SHORT - cDimPg	0x0001
0002	SHORT - cDimData	0x0001
0002	USHORT - cRw	0x0007
0002	USHORT - cCol	0x0001

Size	Structure	Value
1 bit	USHORT - fRwGrand	0x1
1 bit	USHORT - fColGrand	0x1
1 bit	USHORT - unused1	0x0
1 bit	USHORT - fAutoFormat	0x1
1 bit	USHORT - fAtrNum	0x0
1 bit	USHORT - fAtrFmt	0x0
1 bit	USHORT - fAtrAlc	0x0
1 bit	USHORT - fAtrBdr	0x0
1 bit	USHORT - fAtrPat	0x0
1 bit	USHORT - fAtrProc	0x1
6 bits	USHORT - unused2	0x00
0002	AutoFmt8 - itblAutoFmt	0x0001
0002	USHORT - cchTableName	0x0010
0002	USHORT - cchDataName	0x0004
0011	XLUnicodeStringNoCch - stTable	OrdersPivotTable
0005	XLUnicodeStringNoCch - stData	Data

Figure 137: Structure of SxView

ref: A structure that specifies the **range** (A2:C11) that specifies the location of the PivotTable view.

ref.rwFirst: A structure that specifies the first row in the range.

ref.rwFirst.rw: 0x0002 specifies the third row (row 3) in the **sheet**.

ref.rwLast: A structure that specifies the last row in the range.

ref.rwLast.rw: 0x000A specifies the eleventh row (row 11) in the sheet.

ref.colFirst: A structure that specifies the first column in the range.

ref.colFirst.col: 0x0000 specifies the first column (column A) in the sheet.

ref.colLast: A structure that specifies the last column in the range.

ref.colLast.col: 0x0002 specifies the third column (column C) in the sheet.

rwFirstHead: A structure that specifies the first PivotTable **header row**.

rwFirstHead.rw: 0x0004 specifies the fifth row (row 5) in the sheet.

rwFirstData: A structure that specifies the first row that contains PivotTable data.

rwFirstData.rw: 0x0004 specifies the fifth row (row 5) in the sheet.

colFirstData: A structure that specifies the first column that contains PivotTable data.

colFirstData.col: 0x0002 specifies the third column (column C) in the sheet.

iCache: 0x0000 specifies the index of the [PivotCache](#) for this PivotTable, which is the first stream in the `_SX_DB_CUR` storage.

sxaxis4Data: A structure that specifies the default axis for data fields. Only the **sxaxisRow** and **sxaxisCol** bits of the structure are shown, as the rest of the bits are 0.

sxaxis4Data.sxaxisRw: 0x0001 specifies that the [row axis](#) is the default axis for data fields.

sxaxis4Data.sxaxisCol: 0x0000 is required in this field because **sxaxisRw** is 0x0001.

sxaxis4Data.sxaxisPage: 0x0000 is required in this field because **sxaxisRw** is 0x0001.

sxaxis4Data.sxaxisData: 0x0000 is required in this field because **sxaxisRw** is 0x0001.

ipos4Data: 0xFFFF (-1) specifies that the data field is in the default position.

cDim: 0x0005 specifies that there are five fields in the database.

cDimRw: 0x0002 specifies that there are two fields on the row axis.

cDimCol: 0x0000 specifies that there are no fields on the [column axis](#).

cDimPg: 0x0001 specifies that there is one field on the [page axis](#).

cDimData: 0x0001 specifies that there is one field on the [data axis](#).

cRw: 0x0007 specifies that there are seven [pivot lines](#) in the [row area](#) of this PivotTable view.

cCol: 0x0001 specifies that there is one pivot line in the [column area](#) of this PivotTable view.

fRwGrand: 0x0001 specifies that this PivotTable view contains **grand totals** for rows.

fColGrand: 0x0001 specifies that this PivotTable view contains grand totals for columns.

fAutoFormat: 0x0001 specifies that this PivotTable has **AutoFormat** applied.

fAtrNum: 0x0000 specifies that this PivotTable does not have AutoFormat applied for numbers.

fAtrFmt: 0x0000 specifies that this PivotTable does not have AutoFormat applied for fonts.

fAtrAlc: 0x0000 specifies that this PivotTable does not have AutoFormat applied for alignment.

fAtrBdr: 0x0000 specifies that this PivotTable does not have AutoFormat applied for **borders**.

fAtrPat: 0x0000 specifies that this PivotTable does not have AutoFormat applied for patterns.

fAtrProc: 0x0000 specifies that this PivotTable has AutoFormat applied for width and height.

itblAutoFmt: XL8_ITBLCLASSIC1 specifies that this PivotTable is using the "Classic" style of AutoFormat.

cchTableName: 0x0010 specifies that the string in **stTable** has 16 characters.

cchDataName: 0x0004 specifies that the string in **stData** has four characters.

stTable: Specifies that the name of this PivotTable view is "OrdersPivotTable".

stData: Specifies that the name of the data [pivot field](#) is "Data".

3.10.8 PivotTable: Sxvd 1

The next record in this example, [Sxvd](#), specifies the first [pivot field](#) ("CustomerName") in the [row axis](#).

Size	Structure	Value
000A	Sxvd - Sxvd	
0002	SXAxis - sxaxis	
1 bit	USHORT - sxaxisRw	0x1
1 bit	USHORT - sxaxisCol	0x0
1 bit	USHORT - sxaxisPage	0x0
1 bit	USHORT - sxaxisData	0x0
12 bits	USHORT - reserved	0x000
0002	USHORT - cSub	0x0001
1 bit	USHORT - fDefault	0x1
1 bit	USHORT - fSum	0x0
1 bit	USHORT - fCounta	0x0
1 bit	USHORT - fAverage	0x0
1 bit	USHORT - fMax	0x0
1 bit	USHORT - fMin	0x0
1 bit	USHORT - fProduct	0x0
1 bit	USHORT - fCount	0x0
1 bit	USHORT - fStdev	0x0
1 bit	USHORT - fStdevp	0x0
1 bit	USHORT - fVariance	0x0
1 bit	USHORT - fVariancecp	0x0
4 bits	USHORT - reserved	0x0
0002	SHORT - cItm	0x0006
0002	USHORT - cchName	0xFFFF

Figure 138: Structure of Sxvd

sxaxis: Specifies the [PivotTable axis](#) to which this pivot field belongs.

sxaxis.sxaxisRw: 0x1 specifies that this pivot field refers to the row axis.

sxaxis.sxaxisCol: 0x0 specifies that this pivot field does not refer to the [column axis](#).

sxaxis.sxaxisPage: 0x0 specifies that this pivot field does not refer to the [page axis](#).

sxaxis.sxaxisData: 0x0 specifies that this pivot field does not refer to the [value axis](#).

cSub: 0x0001 specifies that one subtotal **function** is used for this pivot field.

fDefault: 0x1 specifies that the default subtotal function is applied.

fSum: 0x0 specifies that the **sum** subtotal function is not displayed.

fCounta: 0x0 specifies that the **count** subtotal function is not displayed.

fAverage: 0x0 specifies that the **average** subtotal function is not displayed.

fMax: 0x0 specifies that the **max** subtotal function is not displayed.

fMin: 0x0 specifies that the **min** subtotal function is not displayed.

fProduct: 0x0 specifies that the **sum** subtotal function is not displayed.

fCount: 0x0 specifies that the **count numbers** subtotal function is not displayed.

fStdev: 0x0 specifies that the **standard deviation** subtotal function is not displayed.

fStdevp: 0x0 specifies that the **standard deviation population** subtotal function is not displayed.

fVariance: 0x0 specifies that the **variance** subtotal function is not displayed.

fVariancep: 0x0 specifies that the **variance population** subtotal function is not displayed.

cItm: 0x0006 specifies that there are six [pivot items](#) for this pivot field.

cchName: 0xFFFF specifies that the caption of this pivot field is NULL, which means that the name is inherited from the associated [cache field](#) instead.

3.10.9 PivotTable: SXVI 1

The next record in this example, [SXVI](#), specifies the first [pivot item](#) ("Antonio Moreno Taquería") of this [pivot field](#) ("CustomerName"). This item is filtered out and not visible in the PivotTable report.

Size	Structure	Value
0008	SXVI - SXVI	
0002	SHORT - itmType	0x0000
1 bit	USHORT - fHidden	0x0
1 bit	USHORT - fHideDetail	0x0
1 bit	USHORT - reserved1	0x0
1 bit	USHORT - fFormula	0x0
1 bit	USHORT - fMissing	0x0
11 bits	USHORT - reserved2	0x000
0002	SHORT - iCache	0x0001
0002	USHORT - cchName	0xFFFF

Figure 139: Structure of SXVI

itmType: 0x0000 specifies that the pivot item is a regular data value.

fHidden: 0x0 specifies that the pivot item is not hidden.

fHideDetail: 0x0 specifies that the pivot item is not collapsed (see [Collapsing](#)).

fFormula: 0x0 specifies that the pivot item is not a [calculated item](#).

fMissing: 0x0 specifies that the pivot item exists in the **data source**.

iCache: This field specifies a [cache item](#) in the [cache field](#) that is associated with this pivot field ("CustomerName"). The index 0x01 specifies the second [SXString](#) ("Antonio Moreno Taquería") in the collection following the [SXFDB](#) with **stFieldName**="CustomerName".

cchName: 0xFFFF specifies that this pivot item does not have a caption.

3.10.10 PivotTable: SXVI 2

The next record in this example, [SXVI](#), specifies the [pivot item](#) "Island Trading" in the [PivotTable view](#).

Size	Structure	Value
0008	SXVI - SXVI	
0002	SHORT - itmType	0x0000
1 bit	USHORT - fHidden	0x0
1 bit	USHORT - fHideDetail	0x0
1 bit	USHORT - reserved1	0x0
1 bit	USHORT - fFormula	0x0
1 bit	USHORT - fMissing	0x0
11 bits	USHORT - reserved2	0x000
0002	SHORT - iCache	0x0003
0002	USHORT - cchName	0xFFFF

Figure 140: Structure of SXVI

Fields in this record that are explained in previous record descriptions in this example are omitted for brevity.

itmType: 0x0000 specifies that this pivot item is a regular data value.

fHidden: 0x0 specifies that this pivot item is not hidden.

fHideDetail: 0x0 specifies that this pivot item is not collapsed (see [Collapsing](#)).

fFormula: 0x0 specifies that this pivot item is not a [calculated item](#).

fMissing: 0x0 specifies that this pivot item exists in the **data source**.

iCache: The index 0x03 specifies the fourth [SXString](#) ("Island Trading") in the collection following the [SXFDB](#) with **stFieldName**="CustomerName".

3.10.11 PivotTable: SXVI 3

The next record in this example, [SXVI](#), specifies the [pivot item](#) "Richter Supermarkt" in the [PivotTable view](#).

Size	Structure	Value
0008	SXVI - SXVI	
0002	SHORT - itmType	0x0000
1 bit	USHORT - fHidden	0x0
1 bit	USHORT - fHideDetail	0x1
1 bit	USHORT - reserved1	0x0
1 bit	USHORT - fFormula	0x0
1 bit	USHORT - fMissing	0x0
11 bits	USHORT - reserved2	0x000
0002	SHORT - iCache	0x0002
0002	USHORT - cchName	0xFFFF

Figure 141: Structure of SXVI

Fields in this record that are explained in previous record descriptions in this example are omitted for brevity.

fHideDetail: 0x1 specifies that the pivot item is collapsed (see [Collapsing](#)).

3.10.12 PivotTable: SXVI 4

The next record in this example, [SXVI](#), specifies the Total row in the [PivotTable view](#).

Size	Structure	Value
0008	SXVI - SXVI	
0002	SHORT - itmType	0x0001
1 bit	USHORT - fHidden	0x0
1 bit	USHORT - fHideDetail	0x0
1 bit	USHORT - reserved1	0x0
1 bit	USHORT - fFormula	0x0
1 bit	USHORT - fMissing	0x0
11 bits	USHORT - reserved2	0x000
0002	SHORT - iCache	0xFFFF
0002	USHORT - cchName	0xFFFF

Figure 142: Structure of SXVI

Fields in this record that are explained in previous record descriptions in this example are omitted for brevity.

itmType: 0x0001 specifies that the [pivot item](#) is a subtotal.

iCache: 0xFFFF specifies that the pivot item does not refer to any [cache item](#).

3.10.13 PivotTable: SXVDEx 1

The next record in this example, [SXVDEx](#), specifies the extended information about this ("CustomerName") [pivot field](#).

Size	Structure	Value
0014	SXVDEx - SXVDEx	
1 bit	USHORT - fShowAllItems	0x0
1 bit	USHORT - fDragToRow	0x1
1 bit	USHORT - fDragToColumn	0x1
1 bit	USHORT - fDragToPage	0x1
1 bit	USHORT - fDragToHide	0x1
1 bit	USHORT - fNotDragToData	0x0
1 bit	USHORT - reserved1	0x0
1 bit	USHORT - fServerBased	0x0
1 bit	USHORT - reserved2	0x0
1 bit	USHORT - fAutoSort	0x0
1 bit	USHORT - fAscendSort	0x1
1 bit	USHORT - fAutoShow	0x0
1 bit	USHORT - fTopAutoShow	0x1
1 bit	USHORT - fCalculatedField	0x0
1 bit	USHORT - fPageBreaksBetweenItems	0x0
1 bit	USHORT - fHideNewItems	0x0
5 bits	USHORT - reserved3	0x00
1 bit	USHORT - fOutline	0x0
1 bit	USHORT - fInsertBlankRow	0x0
1 bit	USHORT - fSubtotalAtTop	0x0
8 bits	USHORT - citmAutoShow	0x0A
0002	SHORT - isxdiAutoSort	0xFFFF
0002	SHORT - isxdiAutoShow	0xFFFF
0002	IFmt - ifmt	
0002	USHORT - ifmt	0x0000
000A	SXVDEx_Opt - subName	
0002	USHORT - cchSubName	0xFFFF
0004	ULONG - reserved1	0x00000000

Size	Structure	Value
0004	ULONG - reserved2	0x00000000

Figure 143: Structure of SXVDEx

- fShowAllItems:** 0x0 specifies that all [pivot items](#) in the [PivotTable view](#) are not displayed.
- fDragToRow:** 0x1 specifies that the pivot field can be dragged to the [row axis](#).
- fDragToColumn:** 0x1 specifies that the pivot field can be placed on the [column axis](#).
- fDragToPage:** 0x1 specifies that the pivot field can be dragged to the [page axis](#).
- fDragToHide:** 0x1 specifies that the pivot field can be removed from the PivotTable view.
- fNotDragToData:** 0x0 specifies that the pivot field can be dragged to the data axis.
- fServerBased:** 0x0 is required because the corresponding [cache field](#) is not server-based.
- fAutoSort:** 0x0 specifies that AutoSort is not enabled for this pivot field.
- fAscendSort:** 0x1 specifies that AutoSort order is set to ascending, and if AutoSort is enabled, this pivot field is sorted in ascending order.
- fAutoShow:** 0x0 specifies that **AutoShow** is not enabled on this pivot field.
- fTopAutoShow:** 0x1 specifies that AutoShow is set to show top 10 values rather than bottom 10 values. If AutoShow is enabled, this PivotTable view uses top 10 values for AutoShow (filter).
- fCalculatedField:** 0x0 specifies that this pivot field is not a [calculated field](#).
- fPageBreaksBetweenItems:** 0x0 specifies that a **page break** is not set between different pivot items in the PivotTable view during printing.
- fHideNewItem:** 0x0 specifies that new pivot items that are added to the **data source** are displayed automatically in the PivotTable view when the [PivotTable](#) is refreshed.
- fOutline:** 0x0 specifies that this pivot field is not displayed in **outline** format.
- fInsertBlankRow:** 0x0 specifies that a blank line is not inserted between different pivot items in the PivotTable view.
- fSubtotalAtTop:** 0x0 specifies that subtotals are displayed at the bottom of the list of pivot items for this pivot field.
- citmAutoShow:** 0x0A specifies that 10 pivot items are set to display for the top *n* AutoShow (filter).
- isxdiAutoSort:** 0xFFFF specifies that AutoSort uses current [data item](#).
- isxdiAutoShow:** 0xFFFF specifies that AutoShow is not enabled for this pivot field.
- subName:** Specifies the name of the aggregate **function** used to calculate this pivot field's subtotals.
- subName.cchSubName:** 0xFFFF specifies that there is no aggregate function to use.

3.10.14 PivotTable: Sxvd 2

The next record in this example, [Sxvd](#), specifies the pageField ("OrderDate") of this [PivotTable view](#).

Size	Structure	Value
000A	Sxvd - Sxvd	
0002	SXAxis - sxaxis	
1 bit	USHORT - sxaxisRw	0x0
1 bit	USHORT - sxaxisCol	0x0
1 bit	USHORT - sxaxisPage	0x1
1 bit	USHORT - sxaxisData	0x0
12 bits	USHORT - reserved	0x000
0002	USHORT - cSub	0x0001
1 bit	USHORT - fDefault	0x1
1 bit	USHORT - fSum	0x0
1 bit	USHORT - fCounta	0x0
1 bit	USHORT - fAverage	0x0
1 bit	USHORT - fMax	0x0
1 bit	USHORT - fMin	0x0
1 bit	USHORT - fProduct	0x0
1 bit	USHORT - fCount	0x0
1 bit	USHORT - fStdev	0x0
1 bit	USHORT - fStdevp	0x0
1 bit	USHORT - fVariance	0x0
1 bit	USHORT - fVariancep	0x0
4 bits	USHORT - reserved	0x0
0002	SHORT - cItm	0x0015
0002	USHORT - cchName	0xFFFF

Figure 144: Structure of Sxvd

Fields in this record that are explained in previous record descriptions in this example are omitted for brevity.

sxaxis: This field specifies the [PivotTable axis](#) upon which this [pivot field](#) exists.

sxaxis.sxaxisRw: 0x0 specifies that this pivot field does not refer to the [row axis](#).

sxaxis.sxaxisCol: 0x0 specifies that this pivot field does not refer to the [column axis](#).

sxaxis.sxaxisPage: 0x1 specifies that this pivot field refers to the [page axis](#).

sxaxis.sxaxisData: 0x0 specifies that this pivot field does not refer to the [data axis](#).

cItm: 0x0015 specifies that this pivot field contains 21 [pivot items](#).

3.10.15 PivotTable: SXVI 5

The next record in this example, [SXVI](#), specifies the first [pivot item](#) (5/6/1997) of this page field ("OrderDate"). This pivot item is filtered out and not displayed in the [PivotTable view](#).

Size	Structure	Value
0008	SXVI - SXVI	
0002	SHORT - itmType	0x0000
1 bit	USHORT - fHidden	0x1
1 bit	USHORT - fHideDetail	0x0
1 bit	USHORT - reserved1	0x0
1 bit	USHORT - fFormula	0x0
1 bit	USHORT - fMissing	0x0
11 bits	USHORT - reserved2	0x000
0002	SHORT - iCache	0x0000
0002	USHORT - cchName	0xFFFF

Figure 145: Structure of SXVI

Fields in this record that are explained in previous record descriptions in this example are omitted for brevity.

fHidden: 0x1 specifies that this pivot item is hidden (filtered out).

3.10.16 PivotTable: SXVI 6

The next record in this example, [SXVI](#), specifies the second [pivot item](#) (11/28/1997) of this page field ("OrderDate").

Size	Structure	Value
0008	SXVI - SXVI	
0002	SHORT - itmType	0x0000
1 bit	USHORT - fHidden	0x1
1 bit	USHORT - fHideDetail	0x0
1 bit	USHORT - reserved1	0x0
1 bit	USHORT - fFormula	0x0
1 bit	USHORT - fMissing	0x0
11 bits	USHORT - reserved2	0x000
0002	SHORT - iCache	0x000F
0002	USHORT - cchName	0xFFFF

Figure 146: Structure of SXVI

Fields in this record that are explained in previous record descriptions in this example are omitted for brevity.

fHidden: 0x1 specifies that the pivot item is hidden. Because this pivot item is one of the items showing in the filter in the [page area](#) but is not actually displayed in the report, it is marked as hidden.

3.10.17 PivotTable: SXVI 7

The next record in this example, [SXVI](#), specifies the third [pivot item](#) (12/23/1997) of this page field ("OrderDate").

Size	Structure	Value
0008	SXVI - SXVI	
0002	SHORT - itmType	0x0000
1 bit	USHORT - fHidden	0x0
1 bit	USHORT - fHideDetail	0x0
1 bit	USHORT - reserved1	0x0
1 bit	USHORT - fFormula	0x0
1 bit	USHORT - fMissing	0x0
11 bits	USHORT - reserved2	0x000
0002	SHORT - iCache	0x0010
0002	USHORT - cchName	0xFFFF

Figure 147: Structure of SXVI

Fields in this record that are explained in previous record descriptions in this example are omitted for brevity.

fHidden: 0x0 specifies that the pivot item is not hidden.

3.10.18 PivotTable: SXVDEx 2

The next record in this example, [SXVDEx](#), specifies extended information about this [pivot field](#) ("OrderDate").

Size	Structure	Value
0014	SXVDEx - SXVDEx	
1 bit	USHORT - fShowAllItems	0x0
1 bit	USHORT - fDragToRow	0x1
1 bit	USHORT - fDragToColumn	0x1
1 bit	USHORT - fDragToPage	0x1
1 bit	USHORT - fDragToHide	0x1
1 bit	USHORT - fNotDragToData	0x0

Size	Structure	Value
1 bit	USHORT - reserved1	0x0
1 bit	USHORT - fServerBased	0x0
1 bit	USHORT - reserved2	0x0
1 bit	USHORT - fAutoSort	0x0
1 bit	USHORT - fAscendSort	0x1
1 bit	USHORT - fAutoShow	0x0
1 bit	USHORT - fTopAutoShow	0x1
1 bit	USHORT - fCalculatedField	0x0
1 bit	USHORT - fPageBreaksBetweenItems	0x0
1 bit	USHORT - fHideNewItem	0x0
5 bits	USHORT - reserved3	0x00
1 bit	USHORT - fOutline	0x0
1 bit	USHORT - fInsertBlankRow	0x0
1 bit	USHORT - fSubtotalAtTop	0x0
8 bits	USHORT - citmAutoShow	0x0A
0002	SHORT - isxdiAutoSort	0xFFFF
0002	SHORT - isxdiAutoShow	0xFFFF
0002	IFmt - ifmt	
0002	USHORT - ifmt	0x000E
000A	SXVDEx_Opt - subName	
0002	USHORT - cchSubName	0xFFFF
0004	ULONG - reserved1	0x00000000
0004	ULONG - reserved2	0x00000000

Figure 148: Structure of SXVDEx

Fields in this record that are explained in previous record descriptions in this example are omitted for brevity.

ifmt: Specifies the **number format** of this pivot field.

ifmt.ifmt: 0x000E specifies that the format of this [pivot item](#) is the built-in format **mm-dd-yy**.

3.10.19 PivotTable: Sxvd 3

The next record in this example, [Sxvd](#), specifies the second field in the [row axis](#), "ProductName".

Size	Structure	Value
000A	Sxvd - Sxvd	
0002	SXAxis - sxaxis	
1 bit	USHORT - sxaxisRw	0x1
1 bit	USHORT - sxaxisCol	0x0
1 bit	USHORT - sxaxisPage	0x0
1 bit	USHORT - sxaxisData	0x0
12 bits	USHORT - reserved	0x000
0002	USHORT - cSub	0x0001
1 bit	USHORT - fDefault	0x1
1 bit	USHORT - fSum	0x0
1 bit	USHORT - fCounta	0x0
1 bit	USHORT - fAverage	0x0
1 bit	USHORT - fMax	0x0
1 bit	USHORT - fMin	0x0
1 bit	USHORT - fProduct	0x0
1 bit	USHORT - fCount	0x0
1 bit	USHORT - fStdev	0x0
1 bit	USHORT - fStdevp	0x0
1 bit	USHORT - fVariance	0x0
1 bit	USHORT - fVariancep	0x0
4 bits	USHORT - reserved	0x0
0002	SHORT - cItm	0x0007
0002	USHORT - cchName	0xFFFF

Figure 149: Structure of Sxvd

Fields in this record that are explained in previous record descriptions in this example are omitted for brevity.

cItm: 0x0007 specifies that this [pivot field](#) has seven [pivot items](#).

3.10.20 PivotTable: Sxvd 4

The next record in this example, [Sxvd](#), specifies the [pivot field](#) "UnitPrice", which is not in the [PivotTable view](#).

Size	Structure	Value
000A	Sxvd - Sxvd	

Size	Structure	Value
0002	SXAxis - sxaxis	
1 bit	USHORT - sxaxisRw	0x0
1 bit	USHORT - sxaxisCol	0x0
1 bit	USHORT - sxaxisPage	0x0
1 bit	USHORT - sxaxisData	0x0
12 bits	USHORT - reserved	0x000
0002	USHORT - cSub	0x0001
1 bit	USHORT - fDefault	0x1
1 bit	USHORT - fSum	0x0
1 bit	USHORT - fCounta	0x0
1 bit	USHORT - fAverage	0x0
1 bit	USHORT - fMax	0x0
1 bit	USHORT - fMin	0x0
1 bit	USHORT - fProduct	0x0
1 bit	USHORT - fCount	0x0
1 bit	USHORT - fStdev	0x0
1 bit	USHORT - fStdevp	0x0
1 bit	USHORT - fVariance	0x0
1 bit	USHORT - fVariancecp	0x0
4 bits	USHORT - reserved	0x0
0002	SHORT - cItm	0x0000
0002	USHORT - cchName	0xFFFF

Figure 150: Structure of Sxvd

Fields in this record that are explained in previous record descriptions in this example are omitted for brevity.

sxaxis: Specifies the [PivotTable](#) axis that this pivot field belongs to.

sxaxis.sxaxisRw: 0x0 specifies that this pivot field does not refer to the [row axis](#).

sxaxis.sxaxisCol: 0x0 specifies that this pivot field does not refer to the [column axis](#).

sxaxis.sxaxisPage: 0x0 specifies that this pivot field does not refer to the [page axis](#).

sxaxis.sxaxisData: 0x0 specifies that this pivot field does not refer to the [data axis](#).

fDefault: 0x1 specifies that the default subtotal is applied.

cItm: cItm: 0x0000 specifies that there are no [pivot items](#) for this pivot field. This is because this pivot field is a numeric field, and cache items do not need to be stored for numeric fields.

Records following this record, and before the next [SXVDEx](#) record, are omitted for brevity.

3.10.21 PivotTable: SXVDEx 3

The next record in this example, [SXVDEx](#), specifies extended information about this [pivot field](#) ("UnitPrice").

Size	Structure	Value
0014	SXVDEx - SXVDEx	
1 bit	USHORT - fShowAllItems	0x0
1 bit	USHORT - fDragToRow	0x1
1 bit	USHORT - fDragToColumn	0x1
1 bit	USHORT - fDragToPage	0x1
1 bit	USHORT - fDragToHide	0x1
1 bit	USHORT - fNotDragToData	0x0
1 bit	USHORT - reserved1	0x0
1 bit	USHORT - fServerBased	0x0
1 bit	USHORT - reserved2	0x0
1 bit	USHORT - fAutoSort	0x0
1 bit	USHORT - fAscendSort	0x1
1 bit	USHORT - fAutoShow	0x0
1 bit	USHORT - fTopAutoShow	0x1
1 bit	USHORT - fCalculatedField	0x0
1 bit	USHORT - fPageBreaksBetweenItems	0x0
1 bit	USHORT - fHideNewItems	0x0
5 bits	USHORT - reserved3	0x00
1 bit	USHORT - fOutline	0x0
1 bit	USHORT - fInsertBlankRow	0x0
1 bit	USHORT - fSubtotalAtTop	0x0
8 bits	USHORT - citmAutoShow	0x0A
0002	SHORT - isxdiAutoSort	0xFFFF
0002	SHORT - isxdiAutoShow	0xFFFF
0002	IFmt - ifmt	
0002	USHORT - ifmt	0x002C

Size	Structure	Value
000A	SXVDEx_Opt - subName	
0002	USHORT - cchSubName	0xFFFF
0004	ULONG - reserved1	0x00000000
0004	ULONG - reserved2	0x00000000

Figure 151: Structure of SXVDEx

fShowAllItems: 0x0 specifies that [pivot items](#) that do not currently exist in the [source data](#) are not displayed.

fDragToRow: 0x1 specifies that this pivot field can be placed on the [row axis](#) of this [PivotTable view](#).

fDragToColumn: 0x1 specifies that this pivot field can be placed on the [column axis](#) of this PivotTable view.

fDragToPage: 0x1 specifies that this pivot field can be dragged to the [page axis](#) of this PivotTable view.

fDragToHide: 0x1 specifies that this pivot field can be removed from the [PivotTable](#) view.

fNotDragToData: 0x0 specifies that this pivot field can be placed on the [data axis](#) of this PivotTable view.

fCalculatedField: 0x0 specifies that this pivot field is not a calculated field.

fOutline: 0x0 specifies that this pivot field is not displayed in **outline** format.

ifmt: Specifies the **number format** of this pivot field.

ifmt.ifmt: 0x002C specifies that this field has the `_(($* #,##0.00_);_($* (#,##0.00);_($* "-"??_);_(@_)` number format applied.

3.10.22 PivotTable: Sxvd 5

The next record in this example, [Sxvd](#), specifies the data field ("Quantity") in the [PivotTable view](#).

Size	Structure	Value
000A	Sxvd - Sxvd	
0002	SXAxis - sxaxis	
1 bit	USHORT - sxaxisRw	0x0
1 bit	USHORT - sxaxisCol	0x0
1 bit	USHORT - sxaxisPage	0x0
1 bit	USHORT - sxaxisData	0x1
12 bits	USHORT - reserved	0x000
0002	USHORT - cSub	0x0001
1 bit	USHORT - fDefault	0x1
1 bit	USHORT - fSum	0x0

Size	Structure	Value
1 bit	USHORT - fCounta	0x0
1 bit	USHORT - fAverage	0x0
1 bit	USHORT - fMax	0x0
1 bit	USHORT - fMin	0x0
1 bit	USHORT - fProduct	0x0
1 bit	USHORT - fCount	0x0
1 bit	USHORT - fStdev	0x0
1 bit	USHORT - fStdevp	0x0
1 bit	USHORT - fVariance	0x0
1 bit	USHORT - fVariancep	0x0
4 bits	USHORT - reserved	0x0
0002	SHORT - cItm	0x0000
0002	USHORT - cchName	0xFFFF

Figure 152: Structure of Sxvd

Fields in this record that are explained in previous record descriptions in this example are omitted for brevity.

sxaxis: This field specifies the [PivotTable axis](#) that this [pivot field](#) is on.

sxaxis.sxaxisRw: 0x0 specifies that this pivot field does not refer to the [row axis](#).

sxaxis.sxaxisCol: 0x0 specifies that this pivot field does not refer to the [column axis](#).

sxaxis.sxaxisPage: 0x0 specifies that this pivot field does not refer to the [page axis](#).

sxaxis.sxaxisData: 0x1 specifies that this pivot field refers to the [data axis](#).

cItm: 0x0000 specifies that there are no [pivot items](#) for this pivot field. This is because this pivot field is a numeric field, and cache items do not need to be stored for numeric fields.

Records following this record, and before the next [SXVDEx](#) record, are omitted for brevity.

3.10.23 PivotTable: SXVDEx 4

The next record in this example, [SXVDEx](#), specifies the extended information about this [pivot field](#) ("Quantity").

Size	Structure	Value
0014	SXVDEx - SXVDEx	
1 bit	USHORT - fShowAllItems	0x0
1 bit	USHORT - fDragToRow	0x1
1 bit	USHORT - fDragToColumn	0x1

Size	Structure	Value
1 bit	USHORT - fDragToPage	0x1
1 bit	USHORT - fDragToHide	0x1
1 bit	USHORT - fNotDragToData	0x0
1 bit	USHORT - reserved1	0x0
1 bit	USHORT - fServerBased	0x0
1 bit	USHORT - reserved2	0x0
1 bit	USHORT - fAutoSort	0x0
1 bit	USHORT - fAscendSort	0x1
1 bit	USHORT - fAutoShow	0x0
1 bit	USHORT - fTopAutoShow	0x1
1 bit	USHORT - fCalculatedField	0x0
1 bit	USHORT - fPageBreaksBetweenItems	0x0
1 bit	USHORT - fHideNewItems	0x0
5 bits	USHORT - reserved3	0x00
1 bit	USHORT - fOutline	0x0
1 bit	USHORT - fInsertBlankRow	0x0
1 bit	USHORT - fSubtotalAtTop	0x0
8 bits	USHORT - citmAutoShow	0x0A
0002	SHORT - isxdiAutoSort	0xFFFF
0002	SHORT - isxdiAutoShow	0xFFFF
0002	IFmt - ifmt	
0002	USHORT - ifmt	0x0000
000A	SXVDEx_Opt - subName	
0002	USHORT - cchSubName	0xFFFF
0004	ULONG - reserved1	0x00000000
0004	ULONG - reserved2	0x00000000

Figure 153: Structure of SXVDEx

Fields in this record that are explained in previous record descriptions in this example are omitted for brevity.

ifmt: A field that specifies the **number format** of this pivot field.

ifmt.ifmt: 0x0000 specifies that the General number format is applied.

3.10.24 PivotTable: SxIvd

The next record in this example, [SxIvd](#), specifies an array of references to [pivot fields](#) on the [row axis](#). Because **cDimRw** is 2 and **cDimCol** is 0 for the parent [SxView](#), this contains an array of rows.

Size	Structure	Value
0004	SxIvd - Sxivd	
0004	rgSxivd - rgSxivd	
0002	SxIvdRw - SxIvdRw[0]	
0002	SHORT - rw	0x0000
0002	SxIvdRw - SxIvdRw[1]	
0002	SHORT - rw	0x0002

Figure 154: Structure of Sxivd

rgSxivd: A field that specifies an array of references to pivot fields.

rgSxivd.SxIvdRw[0]: A field that specifies a reference to a pivot field on the row axis.

rgSxivd.SxIvdRw[0].rw: 0x0000 specifies the first pivot field.

rgSxivd.SxIvdRw[1]: A field that specifies a reference to a pivot field on the row axis.

rgSxivd.SxIvdRw[1].rw: 0x0002 specifies the third pivot field.

3.10.25 PivotTable: SXPI

The next record in this example, [SXPI](#), specifies an array of [SXPI Item](#) (information about the [PivotTable](#) page item) structures that specify the [pivot items](#) on the [page axis](#) of this PivotTable. There is one item in the array because the **cDimPg** field of the [SxView](#) record for the [PivotTable view](#) is 1.

Size	Structure	Value
0006	SXPI - SXPI	
0006	SXPI_Item - rgsxpi	
0006	SXPI_Item - SXPI_Item[0]	
0002	SHORT - isxvd	0x0001
0002	SHORT - isxvi	0x7FFD
0002	SHORT - idObj	0x0001

Figure 155: Structure of SXPI

rgsxpi: Specifies an array of page item information or SXPI_Item Structures.

rgsxpi.SXPI_Item[0]: Specifies the first item in the [page area](#).

rgsxpi.SXPI_Item[0].isxvd: 0x0001 specifies the second [pivot field](#), "OrderDate".

rgsxpi.SXPI_Item[0].isxvi: 0x7FFD specifies that all pivot items are used by the "OrderDate" pivot field.

rgsxpi.SXPI_Item[0].idObj: 0x001 which specifies the object identifier of the [Obj](#) record with the page item drop-down arrow.

3.10.26 PivotTable: SXDI

The next record in this example, [SXDI](#), specifies the [data item](#) "Quantity" for this [PivotTable view](#).

Size	Structure	Value
001E	SXDI - SXDI	
0002	SHORT - isxvdData	0x0004
0002	SHORT - iiftab	0x0000
0002	SHORT - df	0x0000
0002	SHORT - isxvd	0x0000
0002	SHORT - isxvi	0x0000
0002	IFmt - ifmt	
0002	USHORT - ifmt	0x0000
0002	USHORT - cchName	0x000F
0010	XLUnicodeStringNoCch - stName	Sum Of Quantity

Figure 156: Structure of SXDI

isxvdData: A field that specifies a [pivot field](#) in the form of an index in the collection of pivot fields specified by [SXFDB](#). The value 0x04 specifies the fifth pivot field, "Quantity".

iiftab: 0x0000 specifies the "Sum of values" **aggregation function**.

df: 0x0000 specifies that this data item is to be displayed as its raw value with no calculation applied.

isxvd: 0x0000 is required because **df** is 0x0000.

isxvi: 0x0000 is required because **df** is 0x0000.

cchName: 0x000F specifies that the length of this data item is 15 characters.

stName: "Sum Of Quantity" specifies the name of this data item.

3.10.27 PivotTable: SXLI 1

Because the **cRw** and **cCol** fields of the [SxView](#) record are greater than zero, this example contains two [SXLI](#) records. This first SXLI specifies the [pivot lines](#) for the [row area](#).

Size	Structure	Value
0054	SXLI - SXLI	
0054	SXLIItem - rgsxli	
000C	SXLIItem - SXLIItem[0]	
0002	SHORT - cSic	0x0000

Size	Structure	Value
15 bits	USHORT - itmType	0x0000
1 bit	USHORT - reserved1	0x0
0002	SHORT - isxviMac	0x0002
1 bit	USHORT - fMultiDataName	0x0
8 bits	USHORT - iData	0x00
1 bit	USHORT - fSbt	0x0
1 bit	USHORT - fBlock	0x0
1 bit	USHORT - fGrand	0x0
1 bit	USHORT - fMultiDataOnAxis	0x0
1 bit	USHORT - unused1	0x0
1 bit	USHORT - unused2	0x0
1 bit	USHORT - reserved2	0x0
0004	SHORT - rgisxvi	
0002	SHORT - isxvi[0]	0x0002
0002	SHORT - isxvi[1]	0x0002
000C	SXLIItem - SXLIItem[1]	
0002	SHORT - cSic	0x0000
15 bits	USHORT - itmType	0x0001
1 bit	USHORT - reserved1	0x0
0002	SHORT - isxviMac	0x0001
1 bit	USHORT - fMultiDataName	0x0
8 bits	USHORT - iData	0x00
1 bit	USHORT - fSbt	0x1
1 bit	USHORT - fBlock	0x0
1 bit	USHORT - fGrand	0x0
1 bit	USHORT - fMultiDataOnAxis	0x0
1 bit	USHORT - unused1	0x0
1 bit	USHORT - unused2	0x0
1 bit	USHORT - reserved2	0x0
0004	SHORT - rgisxvi	
0002	SHORT - isxvi[0]	0x0002

Size	Structure	Value
0002	SHORT - isxvi[1]	0x0002
000C	SXLIItem - SXLIItem[2]	
0002	SHORT - cSic	0x0000
15 bits	USHORT - itmType	0x0000
1 bit	USHORT - reserved1	0x0
0002	SHORT - isxviMac	0x0002
1 bit	USHORT - fMultiDataName	0x0
8 bits	USHORT - iData	0x00
1 bit	USHORT - fSbt	0x0
1 bit	USHORT - fBlock	0x0
1 bit	USHORT - fGrand	0x0
1 bit	USHORT - fMultiDataOnAxis	0x0
1 bit	USHORT - unused1	0x0
1 bit	USHORT - unused2	0x0
1 bit	USHORT - reserved2	0x0
0004	SHORT - rgisxvi	
0002	SHORT - isxvi[0]	0x0003
0002	SHORT - isxvi[1]	0x0000
000C	SXLIItem - SXLIItem[3]	
0002	SHORT - cSic	0x0001
15 bits	USHORT - itmType	0x0000
1 bit	USHORT - reserved1	0x0
0002	SHORT - isxviMac	0x0002
1 bit	USHORT - fMultiDataName	0x0
8 bits	USHORT - iData	0x00
1 bit	USHORT - fSbt	0x0
1 bit	USHORT - fBlock	0x0
1 bit	USHORT - fGrand	0x0
1 bit	USHORT - fMultiDataOnAxis	0x0
1 bit	USHORT - unused1	0x0
1 bit	USHORT - unused2	0x0

Size	Structure	Value
1 bit	USHORT - reserved2	0x0
0004	SHORT - rgisxvi	
0002	SHORT - isxvi[0]	0x0003
0002	SHORT - isxvi[1]	0x0003
000C	SXLIItem - SXLIItem[4]	
0002	SHORT - cSic	0x0000
15 bits	USHORT - itmType	0x0001
1 bit	USHORT - reserved1	0x0
0002	SHORT - isxviMac	0x0001
1 bit	USHORT - fMultiDataName	0x0
8 bits	USHORT - iData	0x00
1 bit	USHORT - fSbt	0x1
1 bit	USHORT - fBlock	0x0
1 bit	USHORT - fGrand	0x0
1 bit	USHORT - fMultiDataOnAxis	0x0
1 bit	USHORT - unused1	0x0
1 bit	USHORT - unused2	0x0
1 bit	USHORT - reserved2	0x0
0004	SHORT - rgisxvi	
0002	SHORT - isxvi[0]	0x0003
0002	SHORT - isxvi[1]	0x0003
000C	SXLIItem - SXLIItem[5]	
0002	SHORT - cSic	0x0000
15 bits	USHORT - itmType	0x0000
1 bit	USHORT - reserved1	0x0
0002	SHORT - isxviMac	0x0001
1 bit	USHORT - fMultiDataName	0x0
8 bits	USHORT - iData	0x00
1 bit	USHORT - fSbt	0x0
1 bit	USHORT - fBlock	0x0
1 bit	USHORT - fGrand	0x0

Size	Structure	Value
1 bit	USHORT - fMultiDataOnAxis	0x0
1 bit	USHORT - unused1	0x0
1 bit	USHORT - unused2	0x1
1 bit	USHORT - reserved2	0x0
0004	SHORT - rgisxvi	
0002	SHORT - isxvi[0]	0x0004
0002	SHORT - isxvi[1]	0x7FFF
000C	SXLIItem - SXLIItem[6]	
0002	SHORT - cSic	0x0000
15 bits	USHORT - itmType	0x000D
1 bit	USHORT - reserved1	0x0
0002	SHORT - isxviMac	0x0001
1 bit	USHORT - fMultiDataName	0x0
8 bits	USHORT - iData	0x00
1 bit	USHORT - fSbt	0x1
1 bit	USHORT - fBlock	0x0
1 bit	USHORT - fGrand	0x1
1 bit	USHORT - fMultiDataOnAxis	0x0
1 bit	USHORT - unused1	0x0
1 bit	USHORT - unused2	0x0
1 bit	USHORT - reserved2	0x0
0004	SHORT - rgisxvi	
0002	SHORT - isxvi[0]	0x0000
0002	SHORT - isxvi[1]	0x0000

Figure 157: Structure of SXLI

Fields that appear in several SXLIItem structures with the same values are omitted for brevity.

rgsxli: A field that contains an array of SXLIItem structures, which specify the pivot lines present in this [PivotTable](#).

rgsxli.SXLIItem[0]: Specifies the first pivot line and its [pivot items](#) in the [row axis](#).

rgsxli.SXLIItem[0].cSic: 0x0000 specifies that no pivot items in the **rgisxvi** array are identical to the first pivot items in the previous pivot line item in this record.

rgsxli.SXLIItem[0].itmType: 0x0000 specifies that the pivot item is a regular data value.

rgsxli.SXLIItem[0].isxviMac: 0x0002 specifies that this pivot line contains two pivot items.

rgsxli.SXLIItem[0].fMultiDataName: 0x0 specifies that the [data field](#) name is used for the total.

rgsxli.SXLIItem[0].iData: 0x00 specifies that the data item for this line item is "Quantity" (the only data item in this PivotTable).

rgsxli.SXLIItem[0].fSbt: 0x0 specifies that this pivot item does not represent a subtotal.

rgsxli.SXLIItem[0].fBlock: 0x0 specifies that this pivot item is not a block total.

rgsxli.SXLIItem[0].fGrand: 0x0 specifies that this pivot item is not a **grand total**.

rgsxli.SXLIItem[0].fMultiDataOnAxis: 0x0 specifies that this pivot line does not contain multiple data fields.

rgsxli.SXLIItem[0].rgisxvi: Specifies [pivot line entries](#) for this pivot line.

rgsxli.SXLIItem[0].rgisxvi.isxvi[0]: A field that specifies a pivot item index, because the [SxIvd](#) record with the same index, **rgSxivd.SxIvdRw[0]**, specifies a pivot item index. 0x0002 specifies the third pivot item ([SXVI](#)) within this [Sxvd](#) ("CustomerName") record. The referenced pivot item contains an index which refers to the fourth cache item ([SXString](#)) of the corresponding [cache field](#) ("CustomerName"). The fourth [cache item](#) within this cache field is "Island Trading".

rgsxli.SXLIItem[0].rgisxvi.isxvi[1]: A field that specifies a pivot item index, because the [SxIvd](#) record with the same index, **rgSxivd.SxIvdRw[1]**, specifies a pivot item index. 0x0002 specifies the third pivot item ([SXVI](#)) within this [Sxvd](#) ("ProductName"). The referenced pivot item contains an index which refers to the fourth cache item ([SXString](#)) of the corresponding cache field ("ProductName"). The fourth cache item within this cache field is "Ipoh Coffee".

rgsxli.SXLIItem[1]: Specifies the second pivot line and its pivot items in the row axis.

rgsxli.SXLIItem[1].itmType: 0x0001 specifies that the pivot item is a subtotal.

rgsxli.SXLIItem[1].isxviMac: 0x0001 specifies that this pivot line contains one item.

rgsxli.SXLIItem[1].fSbt: 0x1 specifies that this item is a subtotal.

rgsxli.SXLIItem[2]: Specifies the third pivot line and its pivot items in the row axis.

rgsxli.SXLIItem[2].rgisxvi: Specifies pivot line entries for this pivot line.

rgsxli.SXLIItem[2].rgisxvi.isxvi[0]: A field that specifies a pivot item index, because the [SxIvd](#) record with the same index, **rgSxivd.SxIvdRw[0]**, specifies a pivot item index. 0x0003 specifies the fourth pivot item ([SXVI](#)) within this [Sxvd](#) ("CustomerName"). The referenced pivot item contains an index which refers to the fifth cache item ([SXString](#)) of the corresponding cache field ("CustomerName"). The first cache item within this cache field is "Königlich Essen".

rgsxli.SXLIItem[2].rgisxvi.isxvi[1]: A field that specifies a pivot item index, because the [SxIvd](#) record with the same index, **rgSxivd.SxIvdRw[1]**, specifies a pivot item index. 0x0000 specifies the first pivot item ([SXVI](#)) within this [Sxvd](#) ("ProductName") record. The referenced pivot item contains an index which refers to the first cache item ([SXString](#)) of the corresponding cache field ("ProductName"). The first cache item within this cache field is "Geitost".

rgsxli.SXLIItem[3]: Specifies the fourth pivot line and its pivot items in the row axis.

rgsxli.SXLIItem[3].cSic: 0x0001 specifies that one pivot item in the **rgisxvi** array is identical to the first pivot item in the previous pivot line item in this record.

rgsxli.SXLIItem[3].rgisxvi: Specifies pivot line entries for this pivot line.

rgsxli.SXLIItem[3].rgisxvi.isxvi[0]: A field that specifies a pivot item index, because the SxIvd record with the same index, **rgSxivd.SxIvdRw[0]**, specifies a pivot item index. 0x0003 specifies the fourth pivot item (SXVI) within this Sxvd ("CustomerName") record. The referenced pivot item contains an index which refers to the fifth cache item (SXString) of the corresponding cache field ("CustomerName"). The fifth cache item within this cache field is "Königlich Essen".

rgsxli.SXLIItem[3].rgisxvi.isxvi[1]: A field that specifies a pivot item index, because the SxIvd record with the same index, **rgSxivd.SxIvdRw[1]**, specifies a pivot item index. 0x0003 specifies the fourth pivot item (SXVI) within this Sxvd ("ProductName") record. The referenced pivot item contains an index which refers to the third cache item (SXString) of the corresponding cache field ("ProductName"). The third cache item within this cache field is "Perth Pasties".

The next pivot line is similar to the earlier subtotal pivot line and is not described here.

rgsxli.SXLIItem[5]: Specifies the sixth pivot line and its pivot items in the row axis.

rgsxli.SXLIItem[5].rgisxvi: Specifies pivot line entries for this pivot line.

rgsxli.SXLIItem[5].rgisxvi.isxvi[0]: A field that specifies a pivot item index, because the SxIvd record with the same index, **rgSxivd.SxIvdRw[0]**, specifies a pivot item index. 0x0004 specifies the fourth pivot item (SXVI) within this Sxvd ("CustomerName") record. The referenced pivot item contains an index which refers to the third cache item (SXString) of the corresponding cache field ("ProductName"). The third cache item within this cache field is "Richter Supermarkt".

rgsxli.SXLIItem[5].rgisxvi.isxvi[1]: 0x7FFF specifies that there is no pivot item in this position and the cell is blank.

rgsxli.SXLIItem[6]: Specifies the seventh pivot line and its pivot items in the row axis.

rgsxli.SXLIItem[6].itmType: 0x000D specifies that the pivot item is a grand total.

rgsxli.SXLIItem[6].fGrand: 0x1 specifies that this pivot item is a grand total.

rgsxli.SXLIItem[6].rgisxvi: Specifies pivot line entries for this pivot line.

rgsxli.SXLIItem[6].rgisxvi.isxvi[0]: This field has the value 0x0000 because this pivot item is a grand total (**fGrand=1**).

rgsxli.SXLIItem[6].rgisxvi.isxvi[1]: This field has the value 0x0000 because this pivot item is a grand total (**fGrand=1**).

3.10.28 PivotTable: SXLI 2

This second [SXLI](#) record specifies the [pivot line](#) item structures for the [column axis](#). The size of this array (one item) is determined by the **cCol** field of the [SxView](#) record.

Size	Structure	Value
0008	SXLI - SXLI	
0008	SXLIItem - rgsxli	
0008	SXLIItem - SXLI_Item[0]	
0002	SHORT - cSic	0x0000
15 bits	USHORT - itmType	0x0000
1 bit	USHORT - reserved1	0x0

Size	Structure	Value
0002	SHORT - isxviMac	0x0000
1 bit	USHORT - fMultiDataName	0x0
8 bits	USHORT - iData	0x00
1 bit	USHORT - fSbt	0x0
1 bit	USHORT - fBlock	0x0
1 bit	USHORT - fGrand	0x0
1 bit	USHORT - fMultiDataOnAxis	0x0
1 bit	USHORT - unused1	0x0
1 bit	USHORT - unused2	0x0
1 bit	USHORT - reserved2	0x0

Figure 158: Structure of SXLI

All values of this record are 0 because there is no field or any item in column axis. Because of this, none of the fields are described in this section.

3.10.29 PivotTable: SXEx

The next record in this example, [SXEx](#), specifies additional properties of this [PivotTable view](#).

Size	Structure	Value
0018	SXEx - Sxex	
0002	USHORT - csxformat	0x0000
0002	USHORT - cchErrorString	0xFFFF
0002	USHORT - cchNullString	0xFFFF
0002	USHORT - cchTag	0xFFFF
0002	USHORT - csxselect	0x0000
0002	DRw - crwPage	
0002	USHORT - drw	0x0001
0002	DCol - ccolPage	
0002	USHORT - dcol	0x0001
1 bit	USHORT - fAcrossPageLay	0x0
8 bits	USHORT - cWrapPage	0x00
1 bit	USHORT - unused	0x1
1 bit	USHORT - reserved1	0x0
5 bits	USHORT - reserved2	0x00

Size	Structure	Value
1 bit	USHORT - fEnableWizard	0x1
1 bit	USHORT - fEnableDrilldown	0x1
1 bit	USHORT - fEnableFieldDialog	0x1
1 bit	USHORT - fPreserveFormatting	0x1
1 bit	USHORT - fMergeLabels	0x0
1 bit	USHORT - fDisplayErrorString	0x0
1 bit	USHORT - fDisplayNullString	0x1
1 bit	USHORT - fSubtotalHiddenPageItems	0x0
8 bits	USHORT - reserved3	0x00
0002	USHORT - cchPageFieldStyle	0xFFFF
0002	USHORT - cchTableStyle	0xFFFF
0002	USHORT - cchVacateStyle	0xFFFF

Figure 159: Structure of Sxex

csxformat: 0x0000 specifies that no [SxFormat](#) records follow this record.

cchErrorString: 0xFFFF specifies that a custom string displayed in **cells** that contain errors does not exist.

cchNullString: 0xFFFF specifies that a custom string displayed in cells that contain NULL values does not exist.

cchTag: 0xFFFF specifies that a custom string saved with this PivotTable view does not exist.

csxselect: 0x0000 specifies that no [SxSelect](#) records follow this record.

crwPage: Specifies the number of rows in the [page area](#) of the PivotTable view.

crwPage.drw: 0x0001 specifies that this PivotTable view contains one row on the [page axis](#).

ccolPage: Specifies the number of columns in the page area in the PivotTable view.

ccolPage.dcol: 0x0001 specifies that this PivotTable view contains one column on the page axis.

fAcrossPageLay: 0x0 specifies that multiple [pivot fields](#) on the page axis will be displayed in the page area from the top to the bottom first, as fields are added, before moving to another column.

cWrapPage: 0x00 specifies that pivot fields in the page area do not wrap, as specified by **fAcrossPageLay**.

fEnableWizard: 0x1 specifies that the application displays a user interface to interact with the PivotTable view.

fEnableDrilldown: 0x1 specifies that details can be shown for cells in the [data area](#).

fEnableFieldDialog: 0x1 specifies that a user interface for setting properties of a pivot field can be displayed.

fPreserveFormatting: 0x1 specifies that formatting is preserved when the PivotTable view is recalculated.

fMergeLabels: 0x0 specifies that empty cells adjacent to the cells displaying [pivot item](#) captions of pivot fields on the [row axis](#) and [column axis](#) of this PivotTable view are not merged into a single cell.

fDisplayErrorString: 0x0 specifies that the PivotTable view does not display a custom error string in cells that contain errors.

fDisplayNullString: 0x1 specifies that the PivotTable view displays a custom string in cells that contain NULL values.

fSubtotalHiddenPageItems: 0x0 specifies that hidden pivot items, as specified by [SXVI](#) records with the **fHidden** field equal to 1, of a pivot field on the page axis with the **isxvi** field of the corresponding [SXPI Item](#) structure equal to 0x7FFD, are filtered out when calculating the PivotTable view.

cchPageFieldStyle: 0xFFFF specifies that no **style** is applied in the page area of the PivotTable view.

cchTableStyle: 0xFFFF specifies that no style is applied in the [body](#) of the PivotTable view.

cchVacateStyle: 0xFFFF specifies that no style is applied to cells that become empty when the PivotTable view is recalculated.

3.10.30 PivotTable: QsiSxTag

The next record in this example, [QsiSxTag](#), specifies the name and **refresh** information for this [PivotTable](#).

Size	Structure	Value
0025	QsiSxTag - QsiSxTag	
0004	FrtHeaderOld - frtHeader	
0002	USHORT - rt	0x0802
0002	FrtFlags - grbitFrt	
1 bit	USHORT - fFrtRef	0x0
1 bit	USHORT - fFrtAlert	0x0
14 bits	USHORT - reserved	0x0000
0002	SHORT - fSx	0x0001
1 bit	USHORT - fEnableRefresh	0x1
1 bit	USHORT - fInvalid	0x0
1 bit	USHORT - fTensorEx	0x0
13 bits	USHORT - reserved1	0x0000
0004	SXView9Save - dwQsiFuture	
1 bit	USHORT - fNoStencil	0x0
1 bit	USHORT - fHideTotAnnotation	0x1

Size	Structure	Value
1 bit	USHORT - reserved1	0x0
1 bit	USHORT - fIncludeEmptyRw	0x0
1 bit	USHORT - fIncludeEmptyCol	0x0
11 bits	USHORT - reserved2	0x000
16 bits	USHORT - reserved3	0x0000
0001	BYTE - verSxLastUpdated	0x02
0001	BYTE - verSxUpdatableMin	0x00
0001	BYTE - obCchName	0x10
0001	BYTE - reserved2	0x00
0013	XLUnicodeString - stName	OrdersPivotTable
0002	USHORT - unused	0x0100

Figure 160: Structure of QsiSxTag

frtHeader: A structure that specifies a [future record](#) type header.

frtHeader.rt: 0x0802 specifies the record type identifier and is required.

frtHeader.grbitFrt: 0x00 specifies a constant value of 0x00.

fSx: 0x0001 specifies that this record relates to a PivotTable.

fEnableRefresh: 0x1 specifies that the PivotTable is to be refreshed with data from an external **data source**.

fInvalid: 0x0 specifies that the PivotTable needs to be refreshed.

fTensorEx: 0x0 specifies that the PivotTable is not an **OLAP** report.

dwQsiFuture: Specifies additional option flags for a PivotTable.

dwQsiFuture.fNoStencil: 0x0 specifies that the drawing of large drop zones is enabled for this PivotTable view that has no data fields.

dwQsiFuture.fHideTotAnnotation: 0x1 specifies that annotation for the total in this [OLAP PivotTable view](#) is hidden.

dwQsiFuture.fIncludeEmptyRw: 0x0 specifies that empty rows from an OLAP data source are not shown in this PivotTable view.

dwQsiFuture.fIncludeEmptyCol: 0x0 specifies that empty columns from an OLAP data source are not shown in this PivotTable view.

verSxLastUpdated: 0x02 specifies the [data functionality level](#) that this PivotTable was last refreshed with.

verSxUpdatableMin: 0x00 specifies the minimum version of the application that can refresh this PivotTable.

stName: "OrdersPivotTable" specifies the name of this PivotTable.

3.10.31 PivotTable: SXViewEx9

QsiSxTag The next record in this example, [SXViewEx9](#), specifies extensions to the [PivotTable view](#).

Size	Structure	Value
0011	SXViewEx9 - Sxviewex9	
0002	USHORT - rt	0x0810
1 bit	USHORT - reserved1	0x0
1 bit	USHORT - fFrtAlert	0x0
14 bits	USHORT - reserved2	0x0000
0004	ULONG - reserved3	0x00000000
1 bit	ULONG - reserved4	0x0
1 bit	ULONG - fPrintTitles	0x0
1 bit	ULONG - fLineMode	0x0
2 bits	ULONG - reserved5	0x0
1 bit	ULONG - fRepeatItemsOnEachPrintedPage	0x1
26 bits	ULONG - reserved6	0x00000000
0002	AutoFmt8 - itblAutoFmt	0x0001
0003	XLUnicodeString - chGrand	empty string

Figure 161: Structure of Sxviewex9

rt: 0x0810 specifies a constant record type identifier.

fFrtAlert: 0x0000 specifies that features of this [PivotTable](#) are supported in earlier versions of the **BIFF**.

fPrintTitles: 0x00000000 specifies that print titles for the **worksheet** are not set based on the PivotTable report.

fLineMode: 0x00000000 specifies that no [pivot field](#) is in outline mode. See [subtotaling](#) for more information.

fRepeatItemsOnEachPrintedPage: 0x00000001 specifies that [pivot item](#) captions on the [row axis](#) will be repeated at the top of each printed page for pivot fields in tabular form.

itblAutoFmt: 0x0001 specifies the PivotTable **AutoFormat**. A value of 0x001 specifies XL8_ITBLCLASSIC1 or the **Classic 1** AutoFormat style.

3.10.32 PivotTable: SxAddl 4

The next record in this example, [SxAddl](#), specifies additional information for a [PivotTable view](#) and [PivotCache](#).

Size	Structure	Value
001F	SXAddl SXCView SXDId - SXAddl	

Size	Structure	Value
0006	SXAddlHdr - hdr	
0004	FrtHeaderOld - frtHeaderOld	
0002	USHORT - rt	0x0864
0002	FrtFlags - grbitFrt	
1 bit	USHORT - fFrtRef	0x0
1 bit	USHORT - fFrtAlert	0x0
14 bits	USHORT - reserved	0x0000
0001	BYTE - sxc	0x00
0001	BYTE - sxd	0x00
0019	SXAddl_SXString - stName	
0019	XLUnicodeStringSegmentedSXAddl - stName	OrdersPivotTable

Figure 162: Structure of SXAddl

Fields in this record that are explained in previous record descriptions in this example are omitted for brevity.

hdr: An SXAddlHdr structure that specifies header information for this SXAddl record.

hdr.sxc: 0x00 specifies the current [class](#) as an [SxcView class](#).

hdr.sxd: 0x00 specifies the type of record contained in the **data** field of the containing SXAddl record. This value specifies that the type of this SXAddl record is [SXAddl_SXCCache_SXDId](#).

stName.stName: "OrdersPivotTable" specifies the name of the PivotTable View.

3.10.33 PivotTable: SxAddl 5

The next record in this example, [SxAddl](#), specifies additional information for a [PivotTable view](#) and [PivotCache](#).

Size	Structure	Value
000C	SXAddl_SXCView_SXDVer10Info - SXAddl	
0006	SXAddlHdr - hdr	
0004	FrtHeaderOld - frtHeaderOld	
0002	USHORT - rt	0x0864
0002	FrtFlags - grbitFrt	
1 bit	USHORT - fFrtRef	0x0
1 bit	USHORT - fFrtAlert	0x0
14 bits	USHORT - reserved	0x0000
0001	BYTE - sxc	0x00

Size	Structure	Value
0001	BYTE - sxd	0x02
8 bits	ULONG - bVerSxMacro	0x01
1 bit	ULONG - fDisplayImmediateItems	0x1
1 bit	ULONG - fEnableDataEd	0x0
1 bit	ULONG - fDisableFList	0x0
1 bit	ULONG - fReenterOnLoadOnce	0x0
1 bit	ULONG - fNotViewCalculatedMembers	0x0
1 bit	ULONG - fNotVisualTotals	0x0
1 bit	ULONG - fPageMultipleItemLabel	0x1
1 bit	ULONG - fTensorFillCv	0x0
1 bit	ULONG - fHideDDDData	0x0
3 bits	ULONG - reserved1	0x0
12 bits	ULONG - unused	0x000
0002	USHORT - reserved2	0x0000

Figure 163: Structure of SXAddl

Fields in this record that are explained in previous record descriptions in this example are omitted for brevity.

hdr: An SXAddlHdr structure that specifies header information for this SXAddl record.

hdr.sxc: 0x00 specifies the current [class](#) as an [SxcView class](#).

hdr.sxd: 0x02 specifies the type of record contained in the **data** field of the containing SXAddl record. See [class](#) for more information. This value specifies that the type of this SXAddl record is SXAddl_SXCView_SXDVer10Info.

bVerSxMacro: 0x01 specifies the [data functionality level](#) with which this [PivotTable](#) was created.

fDisplayImmediateItems: 0x1 specifies that [pivot items](#) are displayed in the PivotTable view even when there is no [pivot field](#) on the [data axis](#).

fEnableDataEd: 0x0 specifies the user is not allowed to change values in the data axis of the PivotTable view.

fDisableFList: 0x0 specifies the **PivotTable field list** is enabled.

fReenterOnLoadOnce: 0x0 specifies that this PivotTable view will not **refresh** the next time the **workbook** is opened.

fPageMultipleItemLabel: 0x1 specifies that [OLAP calculated members](#) are **hidden** in the PivotTable view.

3.10.34 PivotTable: SxAddl 6

The next record in this example, [SxAddl](#), specifies additional information for a [PivotTable view](#) and [PivotCache](#). In this record, the **data.hdr.sxd** field specifies that this is the last record of an **SxAddl** record collection.

Size	Structure	Value
000C	SXAddl SXCVIEW SXDEnd - SXAddl	
0006	SXAddlHdr - hdr	
0004	FrtHeaderOld - frtHeaderOld	
0002	USHORT - rt	0x0864
0002	FrtFlags - grbitFrt	
1 bit	USHORT - fFrtRef	0x0
1 bit	USHORT - fFrtAlert	0x0
14 bits	USHORT - reserved	0x0000
0001	BYTE - sxc	0x00
0001	BYTE - sxd	0xFF
0006	reserved - reserved	0x000000000000

Figure 164: Structure of SXAddl

Fields in this record that are explained in previous record descriptions in this example are omitted for brevity.

hdr: An SXAddlHdr structure that specifies header information for this SXAddl record.

hdr.sxc: 0x00 specifies the current [class](#) as an [SxcView class](#).

hdr.sxd: 0xFF specifies the type of record contained in the **data** field of the containing SXAddl record. See [class](#) for more information. This value specifies that the type of this SXAddl record is SXAddl_SXCVIEW_SXDEnd.

3.10.35 PivotTable: SXDB

The next record in this example, [SXDB](#), specifies some of the [PivotCache](#) properties for the [PivotTable](#) in this example. This SXDB record marks the beginning of the set of records in the stream associated with this PivotTable that appear in the [Pivot Cache storage](#) ([_SX_DB_CUR](#)).

Size	Structure	Value
001F	SXDB - SXDB	
0004	LONG - crbdb	0x0000002C
0002	USHORT - idstm	0x0001
1 bit	USHORT - fSaveData	0x1
1 bit	USHORT - fInvalid	0x0

Size	Structure	Value
1 bit	USHORT - fRefreshOnLoad	0x0
1 bit	USHORT - fOptimizeCache	0x0
1 bit	USHORT - fBackgroundQuery	0x0
1 bit	USHORT - fEnableRefresh	0x1
10 bits	USHORT - unused1	0x000
0002	SHORT - unused2	0x0666
0002	SHORT - cfbdbb	0x0005
0002	SHORT - cfdbTot	0x0005
0002	SHORT - crdbUsed	0x0006
0002	USHORT - vsType	0x0001
0002	USHORT - cchWho	0x000A
000B	XLUnicodeStringNoCch - rgb	John Smith

Figure 165: Structure of SXDB

crbdbb: 0x0000002C specifies that there are a total of 44 records in the [source data](#) of this PivotCache.

idstm: 0x0001 specifies the identifier of the stream in the PivotCache storage that contains the PivotCache for this PivotTable. The stream identifier is a four-character string representation of the hexadecimal value. In this case the stream identifier is "0001". This field is equal to the **idstm** field of [SXStreamID](#).

fSaveData: 0x1 specifies that [cache records](#) exist for this PivotCache.

fInvalid: 0x0 specifies that the cache does not need to be refreshed before the next recalculation.

fRefreshOnLoad: 0x0 specifies that the PivotCache is not refreshed on load.

fOptimizeCache: 0x0 specifies that the cache is not optimized for reduced memory usage.

fBackgroundQuery: 0x0 specifies that a **refresh** of the PivotCache is performed synchronously.

fEnableRefresh: 0x1 specifies that the PivotCache refresh is enabled.

cfbdbb: 0x0005 specifies that there are five base [cache fields](#) in the source data.

cfdbTot: 0x0005 specifies that there are a sum total of five base, grouped, and calculated fields in the cache. The value of this field is the same as the **cfbdbb** field because there are no grouped or calculated fields.

crdbUsed: 0x0006 specifies that there are six records in use from the source data in the [PivotTable view](#) as a result of the filtering in the [page area](#).

vsType: 0x0001 specifies that the **data source** is a **sheet** range.

cchWho: 0x000A specifies the length (10) of the following **rgb** string.

rgb: "John Smith" specifies the name of the user who last refreshed the PivotTable.

3.10.36 PivotTable: SXDBEx

The next record in this example, [SXDBEx](#), specifies additional [PivotCache](#) properties.

Size	Structure	Value
000C	SXDBEx - SXDBEx	
0008	DateAsNum - numDate	
0008	Xnum - dateNum	0x40E355907CBEB8CE
0004	DWORD - cSxFormula	0x00000000

Figure 166: Structure of SXDBEx

numDate: A DateAsNum structure that specifies the PivotCache was last refreshed on 5/28/2008.

numDate.dateNum: 0x40E355907CBEB8CE specifies the numeric value 39596.515227662035, which represents the date (5/28/2008 12:21:56 PM) that the PivotCache was last refreshed.

cSxFormula: 0x00000000 specifies that there are no [SXFormula](#) records for this PivotCache.

3.10.37 PivotTable: SXFDB 1

The next records in this example are a series of [SXFDB](#) and related records that specify the [cache fields](#) and their contents. This first SXFDB record specifies details of the CustomerName cache field in the [PivotCache](#). In this example, this cache field is displayed in the [row axis](#) of the [PivotTable](#).

Size	Structure	Value
001D	SXFDB - SXFDB	
1 bit	USHORT - fAllAtoms	0x1
1 bit	USHORT - fSomeUnhashed	0x0
1 bit	USHORT - fUsed	0x0
1 bit	USHORT - fHasParent	0x0
1 bit	USHORT - fRangeGroup	0x0
1 bit	USHORT - fNumField	0x0
1 bit	USHORT - unused1	0x0
1 bit	USHORT - fTextEtcField	0x1
1 bit	USHORT - fnumMinMaxValid	0x0
1 bit	USHORT - fShortItems	0x0
1 bit	USHORT - fNonDates	0x1
1 bit	USHORT - fDateInField	0x0
1 bit	USHORT - unused2	0x0
1 bit	USHORT - fServerBased	0x0
1 bit	USHORT - fCantGetUniqueItems	0x0

Size	Structure	Value
1 bit	USHORT - fCalculatedField	0x0
0002	SHORT - ifdbParent	0x0000
0002	SHORT - ifdbBase	0x0000
0002	SHORT - citmUnq	0x0005
0002	SHORT - csxoper	0x0000
0002	SHORT - cisxoper	0x0000
0002	SHORT - catm	0x0005
000F	XLUnicodeString - stFieldName	CustomerName

Figure 167: Structure of SXFDB

Fields in this record that are ignored because **fHasParent** is 0 are omitted for brevity.

fAllAtoms: 0x1 specifies that the [source data](#) for this cache field is cached. It is cached because the CustomerName cache field is displayed in the PivotTable as the first row field.

fSomeUnhashed: 0x0 specifies that all source data is cached in the PivotCache.

fUsed: 0x0 specifies that no calculated cache fields are used in the PivotTable.

fHasParent: 0x0 specifies that this cache field does not have a parent cache field.

fRangeGroup: 0x0 specifies that this cache field is not grouped by range grouping, as specified in [Grouping](#).

fNumField: 0x0 specifies that the [cache items](#) in this cache field do not contain numeric data.

fTextEtcField: 0x1 specifies that the cache items in this cache field contain text values.

fnumMinMaxValid: 0x0 specifies that a valid minimum or maximum value is not computed for this cache field.

fShortIitms: 0x0 specifies that this cache field does not contain more than 255 cache items.

fNonDates: 0x1 specifies that the cache items in this cache field contain values that are neither time nor date values.

fDateInField: 0x0 specifies that none of the cache items in this cache field contain a time or date value.

fServerBased: 0x0 specifies that this cache field is not a server-based field, as specified in Source Data.

fCantGetUniqueItems: 0x0 specifies that it is possible to retrieve a list of unique items for this cache field.

fCalculatedField: 0x0 specifies that this record is not a [calculated field](#).

csxoper: 0x0000 specifies that there are zero cache item values in this cache field that are based on **child** cache fields.

cisxoper: 0x0000 specifies that there are zero values in the child cache fields of this cache field.

catm: 0x0005 specifies that there are five items in the cache item collection for this cache field.

stFieldName: "CustomerName" specifies the name of this cache field.

The following record, [SXFDType](#), is not included in this example because the **sxvs** field of the [SXVS](#) record in this example is 1.

3.10.38 PivotTable: SXString 1

After the [cache field](#) is specified, a series of records follow it that specify the [cache items](#) in the CustomerName cache field. In this example, the next record is an [SXString](#) record, which specifies a string cache item. This cache item is not displayed in the [PivotTable view](#).

Size	Structure	Value
001A	SXString - SXString	
0002	USHORT - cch	0x0017
0018	XLUnicodeStringNoCch - segment	Great Lakes Food Market

Figure 168: Structure of SXString

cch: 0x0017 specifies the length (23) of the cache item string.

segment: "Great Lakes Food Market" specifies the value of the cache item.

3.10.39 PivotTable: SXString 2

The next record in this example, [SXString](#), specifies a string [cache item](#) in the CustomerName [cache field](#). This cache item does not appear in the [PivotTable view](#).

Size	Structure	Value
001A	SXString - SxString	
0002	USHORT - cch	0x0017
0018	XLUnicodeStringNoCch - segment	Antonio Moreno Taquería

Figure 169: Structure of SxString

cch: 0x0017 specifies the length (23) of the cache item string.

segment: "Antonio Moreno Taquería" specifies the value of the cache item.

This record is followed by 1 additional SXString record that is omitted for brevity.

3.10.40 PivotTable: SXString 3

The next record in this example, [SXString](#), specifies a string [cache item](#) in the CustomerName [cache field](#). This record is included in this example because it is displayed in the [PivotTable view](#).

Size	Structure	Value
0011	SXString - SXString	
0002	USHORT - cch	0x000E
000F	XLUnicodeStringNoCch - segment	Island Trading

Figure 170: Structure of SXString

ch: 0x000E specifies the length (14) of the cache item string.

segment: "Island Trading" specifies the value of the cache item.

Records following this record, and before the next [SXFDB](#) record, are omitted for brevity.

3.10.41 PivotTable: SXFDB 2

The next record in this example, [SXFDB](#), specifies the OrderDate [cache field](#) in the [PivotCache](#). This cache field is displayed in the [page axis](#) of the [PivotTable](#).

Size	Structure	Value
001A	SXFDB - SXFDB	
1 bit	USHORT - fAllAtoms	0x1
1 bit	USHORT - fSomeUnhashed	0x0
1 bit	USHORT - fUsed	0x0
1 bit	USHORT - fHasParent	0x0
1 bit	USHORT - fRangeGroup	0x0
1 bit	USHORT - fNumField	0x0
1 bit	USHORT - unused1	0x0
1 bit	USHORT - fTextEtcField	0x0
1 bit	USHORT - fnumMinMaxValid	0x1
1 bit	USHORT - fShortItems	0x0
1 bit	USHORT - fNonDates	0x0
1 bit	USHORT - fDateInField	0x1
1 bit	USHORT - unused2	0x0
1 bit	USHORT - fServerBased	0x0
1 bit	USHORT - fCantGetUniqueItems	0x0
1 bit	USHORT - fCalculatedField	0x0
0002	SHORT - ifdbParent	0x0000
0002	SHORT - ifdbBase	0x0000
0002	SHORT - citmUnq	0x0014
0002	SHORT - csxoper	0x0000
0002	SHORT - cisxoper	0x0000
0002	SHORT - catm	0x0014
000C	XLUnicodeString - stFieldName	OrderDate

Figure 171: Structure of SXFDB

Fields in this record that are explained in previous record descriptions in this example are omitted for brevity.

fAllAtoms: 0x1 specifies that the [source data](#) for this cache field is cached. It is cached because the OrderDate cache field is displayed in the PivotTable as the first page field.

fNonDates: 0x0 specifies that the [cache items](#) in this cache field are date or time values.

fDateInField: 0x1 specifies that at least one cache item in this cache field is a date or time value.

catm: 0x0014 specifies that there are 20 items in the cache item collection for this cache field.

stFieldName: "OrderDate" specifies the name of the cache field.

Records following this record, and before the next [SxDtr](#) record, are omitted for brevity.

3.10.42 PivotTable: SxDtr 1

The next record in this example, [SxDtr](#), specifies a date [cache item](#) in the OrderDate [cache field](#). This cache item is filtered out in the [PivotTable view](#).

Size	Structure	Value
0008	SxDtr - SxDtr	
0002	USHORT - yr	0x07CD
0002	USHORT - mon	0x0005
0001	BYTE - dom	0x06
0001	BYTE - hr	0x00
0001	BYTE - min	0x00
0001	BYTE - sec	0x00

Figure 172: Structure of SxDtr

yr: 0x07CD specifies the year value (1997) of the cache item.

mon: 0x0005 specifies the month value (5) of the cache item.

dom: 0x06 specifies the day of the month value (6) of the cache item.

hr: 0x00 specifies the hour value (0) of the cache item.

min: 0x00 specifies the minute value (0) of the cache item.

sec: 0x00 specifies the second value (0) of the cache item.

This record is followed by 15 additional SxDtr records that are omitted for brevity.

3.10.43 PivotTable: SxDtr 2

The next record in this example, [SxDtr](#), specifies a date [cache item](#) in the OrderDate page field that is not filtered in the [PivotTable view](#).

Size	Structure	Value
0008	SxDtr - SxDtr	

Size	Structure	Value
0002	USHORT - yr	0x07CD
0002	USHORT - mon	0x000C
0001	BYTE - dom	0x17
0001	BYTE - hr	0x00
0001	BYTE - min	0x00
0001	BYTE - sec	0x00

Figure 173: Structure of SXDtr

Fields in this record that are explained in previous record descriptions in this example are omitted for brevity.

yr: 0x07CD specifies the year value (1997) of the cache item.

mon: 0x000C specifies the month value (12) of the cache item.

dom: 0x17 specifies the day of the month value (23) of the cache item.

Records following this record, and before the next [SXFDB](#) record, are omitted for brevity.

3.10.44 PivotTable: SXFDB 3

The next record in this example, [SXFDB](#), specifies the ProductName [cache field](#) in the [PivotCache](#). This cache field is displayed in the [row axis](#) of the [PivotTable](#).

Size	Structure	Value
001C	SXFDB - SXFDB	
1 bit	USHORT - fAllAtoms	0x1
1 bit	USHORT - fSomeUnhashed	0x0
1 bit	USHORT - fUsed	0x0
1 bit	USHORT - fHasParent	0x0
1 bit	USHORT - fRangeGroup	0x0
1 bit	USHORT - fNumField	0x0
1 bit	USHORT - unused1	0x0
1 bit	USHORT - fTextEtcField	0x1
1 bit	USHORT - fnumMinMaxValid	0x0
1 bit	USHORT - fShortItms	0x0
1 bit	USHORT - fNonDates	0x1
1 bit	USHORT - fDateInField	0x0
1 bit	USHORT - unused2	0x0

Size	Structure	Value
1 bit	USHORT - fServerBased	0x0
1 bit	USHORT - fCantGetUniqueItems	0x0
1 bit	USHORT - fCalculatedField	0x0
0002	SHORT - ifdbParent	0x0000
0002	SHORT - ifdbBase	0x0000
0002	SHORT - citmUnq	0x0006
0002	SHORT - csxoper	0x0000
0002	SHORT - cisxoper	0x0000
0002	SHORT - catm	0x0006
000E	XLUnicodeString - stFieldName	ProductName

Figure 174: Structure of SXFDB

Fields in this record that are explained in previous record descriptions in this example are omitted for brevity.

fAllAtoms: 0x1 specifies that the [source data](#) for this cache field is cached. It is cached because the ProductName cache field is displayed in the PivotTable as the first row field.

fNumField: 0x0 specifies that the [cache items](#) in this cache field do not contain numeric data.

fTextEtcField: 0x1 specifies that the cache items in this cache field contain text values.

catm: 0x0006 specifies that there are six items in the cache item collection for this cache field. The number of items in the cache field was affected in this case by the filtering on the page field.

stFieldName: "ProductName" specifies the name of the cache field.

Records following this record, and before the next SXFDB record, are omitted for brevity.

3.10.45 PivotTable: SXFDB 4

The next record in this example, [SXFDB](#), specifies the UnitPrice [cache field](#) in the [PivotCache](#). This cache field does not appear on any [PivotTable axis](#) in the [PivotTable](#).

Size	Structure	Value
001A	SXFDB - SXFDB	
1 bit	USHORT - fAllAtoms	0x1
1 bit	USHORT - fSomeUnhashed	0x0
1 bit	USHORT - fUsed	0x0
1 bit	USHORT - fHasParent	0x0
1 bit	USHORT - fRangeGroup	0x0
1 bit	USHORT - fNumField	0x1

Size	Structure	Value
1 bit	USHORT - unused1	0x0
1 bit	USHORT - fTextEtcField	0x0
1 bit	USHORT - fnumMinMaxValid	0x1
1 bit	USHORT - fShortIitms	0x0
1 bit	USHORT - fNonDates	0x1
1 bit	USHORT - fDateInField	0x0
1 bit	USHORT - unused2	0x0
1 bit	USHORT - fServerBased	0x0
1 bit	USHORT - fCantGetUniqueItems	0x0
1 bit	USHORT - fCalculatedField	0x0
0002	SHORT - ifdbParent	0x0000
0002	SHORT - ifdbBase	0x0000
0002	SHORT - citmUnq	0x0007
0002	SHORT - csxoper	0x0000
0002	SHORT - cisxoper	0x0000
0002	SHORT - catm	0x0007
000C	XLUnicodeString - stFieldName	UnitPrice

Figure 175: Structure of SXFDB

Fields in this record that are explained in previous record descriptions in this example are omitted for brevity.

fAllAtoms: 0x1 specifies that the [source data](#) for this cache field is cached. Though this cache field is not displayed on any areas of the PivotTable, its source data is cached because it was displayed in the PivotTable at some point.

fNumField: 0x1 specifies that the [cache items](#) in this cache field contain numeric data.

catm: 0x0007 specifies that there are seven items in the cache item collection for this cache field.

stFieldName: "UnitPrice" specifies the name of the cache field.

Records following this record, and before the next [SXNum](#) record, are omitted for brevity.

3.10.46 PivotTable: SXNum 1

The next record in this example, [SXNum](#), specifies a **floating-point number** [cache item](#) in the UnitPrice [cache field](#) that is not in the [PivotTable view](#).

Size	Structure	Value
0008	SXNum - SXNum	

Size	Structure	Value
0008	Xnum - num	0x4004000000000000

Figure 176: Structure of SXNum

num: 0x4004000000000000 specifies the cache item's numeric value is 2.5.

Records following this record, and before the next [SXFDB](#) record, are omitted for brevity.

3.10.47 PivotTable: SXFDB 5

The next record in this example, [SXFDB](#), specifies the Quantity [cache field](#) in the [PivotCache](#). This cache field appears in the [data axis](#) of the [PivotTable](#).

Size	Structure	Value
0019	SXFDB - SXFDB	
1 bit	USHORT - fAllAtoms	0x0
1 bit	USHORT - fSomeUnhashed	0x1
1 bit	USHORT - fUsed	0x0
1 bit	USHORT - fHasParent	0x0
1 bit	USHORT - fRangeGroup	0x0
1 bit	USHORT - fNumField	0x1
1 bit	USHORT - unused1	0x1
1 bit	USHORT - fTextEtcField	0x0
1 bit	USHORT - fnumMinMaxValid	0x1
1 bit	USHORT - fShortItems	0x0
1 bit	USHORT - fNonDates	0x1
1 bit	USHORT - fDateInField	0x0
1 bit	USHORT - unused2	0x0
1 bit	USHORT - fServerBased	0x0
1 bit	USHORT - fCantGetUniqueItems	0x0
1 bit	USHORT - fCalculatedField	0x0
0002	SHORT - ifdbParent	0x0000
0002	SHORT - ifdbBase	0x0000
0002	SHORT - citmUnq	0x001E
0002	SHORT - csxoper	0x0000
0002	SHORT - cisxoper	0x0000
0002	SHORT - catm	0x0000

Size	Structure	Value
000B	XLUnicodeString - stFieldName	Quantity

Figure 177: Structure of SXFDB

Fields in this record that are explained in previous record descriptions in this example are omitted for brevity.

fAllAtoms: 0x0 specifies that the [source data](#) for this cache field is not cached. Though this cache field is displayed in the PivotTable, its source data is not cached because the cache field is displayed in the [data area](#).

fNumField: 0x1 specifies that the [cache items](#) in this cache field contain numeric data.

catm: 0x0000 is 0 because **fAllAtoms** is 0.

stFieldName: "Quantity" specifies the name of this cache field.

Records following this record, and before the next [SXDBB](#) record, are omitted for brevity.

3.10.48 PivotTable: SXDBB 1

The next records in this example are a series of [SXDBB](#) and [SXNum](#) records that specify the [cache records](#) for this [PivotCache](#). This first SXDBB specifies the first cache record.

Size	Structure	Value
0004	SXDBB - SXDBB	
0004	rgb - blob	
0001	BYTE - blob[0]	0x00
0001	BYTE - blob[1]	0x00
0001	BYTE - blob[2]	0x00
0001	BYTE - blob[3]	0x00

Figure 178: Structure of SXDBB

blob.blob[0]: 0x00 specifies the index of the first [cache item](#) (Great Lakes Food Market) within the collection of cache items of the first [cache field](#) (CustomerName).

blob.blob[1]: 0x00 specifies the index of the first cache item (5/6/1997) within the collection of cache items of the second cache field (OrderDate).

blob.blob[2]: 0x00 specifies the index of the first cache item (Geitost) within the collection of cache items of the third cache field (ProductName).

blob.blob[3]: 0x00 specifies the index of the first cache item (2.5) within the collection of cache items of the fourth cache field (UnitPrice).

3.10.49 PivotTable: SXNum 2

The next record in this example, [SXNum](#), specifies the **floating-point number** value for the Quantity [cache field](#) in the [cache record](#) specified by the previous [SXDBB](#).

Size	Structure	Value
0008	SXNum - SXNum	
0008	Xnum - num	0x4020000000000000

Figure 179: Structure of SXNum

num: 0x4020000000000000 specifies that the floating-point number value of this [cache item](#) is 8.

This record is followed by 35 additional pairs of SXDBB and SXNum records that are omitted for brevity.

3.10.50 PivotTable: SXDBB 2

The next record in this example, [SXDBB](#), specifies a [cache record](#) that is displayed within the [PivotTable view](#).

Size	Structure	Value
0004	SXDBB - SXDBB	
0004	rgb - blob	
0001	BYTE - blob[0]	0x04
0001	BYTE - blob[1]	0x11
0001	BYTE - blob[2]	0x00
0001	BYTE - blob[3]	0x00

Figure 180: Structure of SXDBB

blob.blob[0]: 0x04 specifies the index of the fifth [cache item](#) (Königlich Essen) within the collection of cache items of the first [cache field](#) (CustomerName).

blob.blob[1]: 0x11 specifies the index of the eighteenth cache item (12/26/1997) within the collection of cache items of the second cache field (OrderDate).

blob.blob[2]: 0x00 specifies the index of the first cache item (Geitost) within the collection of cache items of the third cache field (ProductName).

blob.blob[3]: 0x00 specifies the index of the seventh cache item (2.5) within the collection of cache items of the fourth cache field (UnitPrice).

3.10.51 PivotTable: SXNum 3

The next record in this example, [SXNum](#), specifies the **floating-point number** value for the Quantity [cache field](#) in the [cache record](#) specified by the previous [SXDBB](#).

Size	Structure	Value
0008	SXNum - SXNum	
0008	Xnum - num	0x4037000000000000

Figure 181: Structure of SXNum

num: 0x4037000000000000 specifies that the floating-point number value of this [cache item](#) is 23.

Records following this record, and before the next [EOF](#) record, are omitted for brevity.

3.10.52 PivotTable: EOF

The next record in this example, [EOF](#), specifies the end of the collection of records for this [PivotCache](#).

Size	Structure
0000	EOF - EOF

Figure 182: Structure of EOF

4 Security Considerations

The password verifier features available in the file format (see [Password Verifier Algorithm](#)) are used to prevent accidental modification, rather than being used as security features. It is possible to remove the passwords by removing the records containing the verifier values.

The translation of passwords from a double-byte **Unicode** string to a new character string in the ANSI code page of the current system converts any Unicode character that cannot be mapped to the ANSI code page of the current system to the 0x3F character in that code page (as described in [ECMA-376](#) part 4, 3.2.29). Replacing these characters with 0x3F when the **hash** is verified will generate positive hash value matches. In certain locales this can be a significant portion of the everyday **character set**.

When a file in this format is saved with obfuscation or encryption (see [Encryption](#)), there are two primary security considerations. First, only certain storages and **streams** are encoded during encryption (see Encryption). Second, for the records that are encrypted, the record type and size are not encrypted in the **BIFF** streams. Therefore, the list of records present in the file can be read from the file without actually decrypting it. Further security considerations regarding the file encryption algorithms are described in [\[MS-OFFCRYPTO\]](#) section 4.1.3.

5 Appendix A: Product Behavior

The information in this specification is applicable to the following Microsoft products or supplemental software. References to product versions include updates to those products.

- Microsoft Excel 97
- Microsoft Excel 2000
- Microsoft Excel 2002
- Microsoft Office Excel 2003
- Microsoft Office Excel 2007
- Microsoft Excel 2010
- Microsoft Excel 2013
- Microsoft Excel 2016
- Microsoft Excel 2019
- Microsoft Excel 2021

Exceptions, if any, are noted in this section. If an update version, service pack or Knowledge Base (KB) number appears with a product name, the behavior changed in that update. The new behavior also applies to subsequent updates unless otherwise specified. If a product edition appears with the product version, behavior is different in that product edition.

Unless otherwise specified, any statement of optional behavior in this specification that is prescribed using the terms "SHOULD" or "SHOULD NOT" implies product behavior in accordance with the SHOULD or SHOULD NOT prescription. Unless otherwise specified, the term "MAY" implies that the product does not follow the prescription.

[<1> Section 2.1.7.15](#): Excel 2002, Office Excel 2003, Office Excel 2007, Excel 2010, and Excel 2013 can write, load, and process the Signatures Stream in a file. Excel 97, Excel 2000 can load a file with a Signatures Stream but ignores it.

[<2> Section 2.1.7.20.1](#): When saving unsupported **future records** (section [2.1.6](#)), Excel 97, Excel 2000, Excel 2002, Office Excel 2003, Office Excel 2007, and Excel 2010 will write those records at the end of the **substream** (section [2.1.3](#)) in which they were encountered during load, in the order in which they were encountered.

[<3> Section 2.1.7.20.2](#): When saving unsupported **future records** (section [2.1.6](#)), Excel 97, Excel 2000, Excel 2002, Office Excel 2003, Office Excel 2007, Excel 2010, and Excel 2013 will write those records at the end of the **substream** (section [2.1.3](#)) in which they were encountered during load, in the order in which they were encountered.

[<4> Section 2.1.7.20.2](#): If a **Continue** record (section [2.4.58](#)) is needed in the **MSODRAWING** rule (section [2.1.7.20.2](#)), Office Excel 2003, Office Excel 2007, Excel 2010, and Excel 2013 can write out an **MsoDrawing** record (section [2.4.170](#)) instead of the first **Continue** record (section [2.4.58](#)).

[<5> Section 2.1.7.20.3](#): When saving unsupported **future records** (section [2.1.6](#)), Excel 97, Excel 2000, Excel 2002, Office Excel 2003, Office Excel 2007, Excel 2010, and Excel 2013 will write those records at the end of the **substream** (section [2.1.3](#)) in which they were encountered during load, in the order in which they were encountered.

[<6> Section 2.1.7.20.3](#): If a **Continue** record (section [2.4.58](#)) is needed in the **MSODRAWINGGROUP** rule, Office Excel 2003, Office Excel 2007, Excel 2010, and Excel 2013 can

write out an **MsoDrawingGroup** record (section [2.4.171](#)) instead of the first **Continue** record (section 2.4.58).

<7> [Section 2.1.7.20.4](#): When saving unsupported **future records** (section 2.1.6), Excel 97, Excel 2000, Excel 2002, Office Excel 2003, Office Excel 2007, and Excel 2010 will write those records at the end of the **substream** (section 2.1.3) in which they were encountered during load, in the order in which they were encountered.

<8> [Section 2.1.7.20.5](#): When saving unsupported **future records** (section 2.1.6), Excel 97, Excel 2000, Excel 2002, Office Excel 2003, Office Excel 2007, and Excel 2010 will write those records at the end of the **substream** (section 2.1.3) in which they were encountered during load, in the order in which they were encountered.

<9> [Section 2.1.7.20.6](#): When saving unsupported **future records** (section 2.1.6), Excel 97, Excel 2000, Excel 2002, Office Excel 2003, Office Excel 2007, Excel 2010, and Excel 2013 will write those records at the end of the **substream** (section 2.1.3) in which they were encountered during load, in the order in which they were encountered.

<10> [Section 2.1.7.20.6](#): Office Excel 2007, Excel 2010, and Excel 2013 can save out a CELLTABLE without a **Row** record (section [2.4.221](#)).

<11> [Section 2.1.7.20.6](#): If a **Continue** record (section 2.4.58) is needed in the **MSODRAWING** rule (section 2.1.7.20.2), Office Excel 2003, Office Excel 2007, Excel 2010, and Excel 2013 can write out an **MsoDrawing** record (section 2.4.170) instead of the first **Continue** record.

<12> [Section 2.1.7.21](#): Only Office Excel 2007 and Excel 2010 can write the **XML Signatures storage**. Only Office Excel 2007 and Excel 2010 can load and process a file with a **XML Signatures storage**; Excel 97, Excel 2000, Excel 2002, Office Excel 2003 can load a file with a **XML Signatures storage** but ignore it.

<13> [Section 2.2.3.11](#): Graph Component for Excel 97, Graph Component for Excel 2000, Graph Component for Excel 2002, Graph Component for Office Excel 2003, Graph Component for Office Excel 2007, and Graph Component for Excel 2010 can create files that do not conform to these rules.

<14> [Section 2.2.3.11](#): Graph Component for Excel 97, Graph Component for Excel 2000, Graph Component for Excel 2002, Graph Component for Office Excel 2003, Graph Component for Office Excel 2007, and Graph Component for Excel 2010 can create files that do not conform to these rules.

<15> [Section 2.2.3.11](#): Graph Component for Excel 97, Graph Component for Excel 2000, Graph Component for Excel 2002, Graph Component for Office Excel 2003, Graph Component for Office Excel 2007, and Graph Component for Excel 2010 can create files that do not conform to these rules.

<16> [Section 2.2.3.11](#): Graph Component for Excel 97, Graph Component for Excel 2000, Graph Component for Excel 2002, Graph Component for Office Excel 2003, Graph Component for Office Excel 2007, and Graph Component for Excel 2010 can create files that do not conform to these rules.

<17> [Section 2.2.3.11](#): Graph Component for Excel 97, Graph Component for Excel 2000, Graph Component for Excel 2002, Graph Component for Office Excel 2003, Graph Component for Office Excel 2007, and Graph Component for Excel 2010 can create files that do not conform to these rules.

<18> [Section 2.2.4.3](#): Office Excel 2007 and Excel 2010 save metadata records when cells contain formulas referencing **cube functions**. However, this metadata does not remain associated with the cells and is only recorded for the purpose of load and calculation optimization.

<19> [Section 2.2.9](#): Excel 97, Excel 2000, Excel 2002, Office Excel 2003, Office Excel 2007, and Excel 2010 warn the user when they enter passwords that contain characters other than alphanumeric characters or punctuation symbols.

<20> [Section 2.2.10](#): In Excel 97, Excel 2000, Excel 2002, and Office Excel 2003 the maximum password length is 15 characters. In Office Excel 2007 and Excel 2010 the maximum password length is 255 characters.

<21> [Section 2.2.10](#): Only Excel 2002 and Office Excel 2003 will save files with XOR obfuscation.

<22> [Section 2.2.10](#): Only Excel 2002, Office Excel 2003, Office Excel 2007, and Excel 2010 will load and save files with RC4 CryptoAPI encryption.

<23> [Section 2.4.3](#): Excel 97, Excel 2000, Excel 2002, Office Excel 2003, Office Excel 2007, and Excel 2010 write a value for this field but ignore it on load.

<24> [Section 2.4.3](#): Excel 97, Excel 2000, Excel 2002, Office Excel 2003, Office Excel 2007, and Excel 2010 write a value for this field but ignore it on load.

<25> [Section 2.4.9](#): When the base unit is not days, and the data is near the base value of the **date system** specified by the **Date1904 record** (section [2.4.77](#)), **catMin** value can underflow and get saved as a large number.

<26> [Section 2.4.9](#): When the base unit is not days, and the data is near the maximum value of the date system specified by the **Date1904 record** (section [2.4.77](#)), **catMax** value can overflow and get saved as a small number.

<27> [Section 2.4.21](#): Excel 97 writes 0x07CC for **rupYear**.

<28> [Section 2.4.21](#): Excel 97, Excel 2000, Excel 2002, Office Excel 2003, Office Excel 2007, Excel 2010, and Excel 2013 set the value to 0 on creation, and change it to 1 in subsequent loading and saving.

<29> [Section 2.4.21](#): This happens only for Excel 97.

<30> [Section 2.4.21](#): Excel 97.

<31> [Section 2.4.21](#): Excel 2000.

<32> [Section 2.4.21](#): Excel 2002.

<33> [Section 2.4.21](#): Office Excel 2003.

<34> [Section 2.4.21](#): Office Excel 2007.

<35> [Section 2.4.21](#): Excel 2010

<36> [Section 2.4.21](#): Excel 2013

<37> [Section 2.4.21](#): Excel 97.

<38> [Section 2.4.21](#): Excel 2000.

<39> [Section 2.4.21](#): Excel 2002.

<40> [Section 2.4.21](#): Office Excel 2003.

<41> [Section 2.4.21](#): Office Excel 2007.

<42> [Section 2.4.21](#): Excel 2010.

<43> [Section 2.4.21](#): Excel 2013

<44> [Section 2.4.22](#): Office Excel 2003, Office Excel 2007, and Excel 2010 will prompt the user in this case.

- <45> [Section 2.4.22](#): This behavior does not apply to Office Excel 2007 and Excel 2010.
- <46> [Section 2.4.30](#): Specifies either Excel 97, Excel 2000, Excel 2002, or Office Excel 2003.
- <47> [Section 2.4.30](#): Specifies either Office Excel 2007 or Excel 2010.
- <48> [Section 2.4.45](#): Excel 97, Excel 2000, Excel 2002, Office Excel 2003, Office Excel 2007, and Excel 2010 save negative values, but at load time the negative values are corrected to 0.
- <49> [Section 2.4.45](#): Excel 97, Excel 2000, Excel 2002, Office Excel 2003, Office Excel 2007, and Excel 2010 save negative values, but at load time the negative values are corrected to 0.
- <50> [Section 2.4.45](#): Excel 97, Excel 2000, Excel 2002, Office Excel 2003, Office Excel 2007, and Excel 2010 save negative values, but at load time the negative values are corrected to 0.
- <51> [Section 2.4.45](#): Excel 97, Excel 2000, Excel 2002, Office Excel 2003, Office Excel 2007, and Excel 2010 save negative values, but at load time the negative values are corrected to 0.
- <52> [Section 2.4.46](#): Office Excel 2007 and Excel 2010 can save values greater than or equal to 0 and less than or equal to 200. In Office Excel 2007 and Excel 2010 the view angle is determined by dividing this value by a factor of 2.
- <53> [Section 2.4.46](#): Office Excel 2007 and Excel 2010 can save values less than 5.
- <54> [Section 2.4.46](#): Office Excel 2007 and Excel 2010 can save values greater than 500.
- <55> [Section 2.4.46](#): Office Excel 2007 and Excel 2010 ignores this bit and will set it back to zero if the file is resaved.
- <56> [Section 2.4.49](#): Excel 2000
- <57> [Section 2.4.49](#): Excel 2000, Excel 2002, Office Excel 2003, Office Excel 2007, Excel 2010, or Excel 2013
- <58> [Section 2.4.49](#): Office Excel 2007
- <59> [Section 2.4.49](#): Excel 97
- <60> [Section 2.4.49](#): Excel 97
- <61> [Section 2.4.49](#): Excel 2000
- <62> [Section 2.4.49](#): Excel 2002, Office Excel 2003
- <63> [Section 2.4.49](#): Office Excel 2007
- <64> [Section 2.4.49](#): Excel 2010
- <65> [Section 2.4.49](#): Excel 2013
- <66> [Section 2.4.49](#): Excel 2000
- <67> [Section 2.4.49](#): Excel 2002, Office Excel 2003
- <68> [Section 2.4.49](#): Office Excel 2007
- <69> [Section 2.4.49](#): Excel 2010
- <70> [Section 2.4.49](#): Excel 2013
- <71> [Section 2.4.54](#): Specifies Office Excel 2007, or Excel 2010.
- <72> [Section 2.4.54](#): Specifies Office Excel 2003, Excel 2002, Excel 2000, or Excel 97.

[<73> Section 2.4.54](#): Specifies Office Excel 2003, Excel 2002, Excel 2000, or Excel 97.

[<74> Section 2.4.54](#): Specifies Office Excel 2003, Excel 2002, Excel 2000, or Excel 97.

[<75> Section 2.4.74](#): Office Excel 2007 and Excel 2010 can save values greater than 254.

[<76> Section 2.4.74](#): Though the maximum zero-based series number is 254, Office Excel 2007 and Excel 2010 can save values greater than 254.

[<77> Section 2.4.91](#): This structure is not loaded or saved by Office Excel 2007 and Excel 2010.

[<78> Section 2.4.97](#): Office Excel 2003, Excel 2002, Excel 2000, and Excel 97 can save out 0 for this field. In these cases, if the **xfprops** field specifies a solid fill pattern as part of the formatting properties, the pattern's color is stored in the background color instead of the foreground color.

[<79> Section 2.4.102](#): Excel 97, Excel 2000, Excel 2002, Office Excel 2003, Office Excel 2007, and Excel 2010 write out this record on save.

[<80> Section 2.4.102](#): Excel 97, Excel 2000, Excel 2002, Office Excel 2003, Office Excel 2007, and Excel 2010 do not ignore this record.

[<81> Section 2.4.104](#): Specifies Excel 97.

[<82> Section 2.4.105](#): Specifies Excel 97, Excel 2000, Excel 2002, Office Excel 2003, Office Excel 2007, or Excel 2010.

[<83> Section 2.4.107](#): Excel 97 can save out a different number of elements.

[<84> Section 2.4.109](#): This record is ignored in Office Excel 2007, and Excel 2010.

[<85> Section 2.4.110](#): This record is ignored in Office Excel 2007 and Excel 2010.

[<86> Section 2.4.117](#): This value is 0x0001 for files created using Office Excel 2007 and Excel 2010.

[<87> Section 2.4.122](#): Excel 97, Excel 2000, Excel 2002, Office Excel 2003, Office Excel 2007, and Excel 2010 can save out 0 for certain **fonts**.

[<88> Section 2.4.122](#): Excel 97, Excel 2000, Excel 2002, Office Excel 2003, Office Excel 2007, and Excel 2010 can also write out the value 0 to specify a black font, or the value 72 to specify the automatic color for a control.

[<89> Section 2.4.122](#): Excel 97, Excel 2000, Excel 2002, Office Excel 2003, Office Excel 2007, and Excel 2010 can also write out values 0 and 100 through 1000 (inclusive).

[<90> Section 2.4.122](#): Excel 97, Excel 2000, Excel 2002, Office Excel 2003, Office Excel 2007, and Excel 2010 can save values greater than 5.

[<91> Section 2.4.126](#): Excel 97, Excel 2000, Excel 2002, Office Excel 2003, Office Excel 2007, and Excel 2010 save values of 383 to 392.

[<92> Section 2.4.129](#): Specifies Excel 2000.

[<93> Section 2.4.129](#): Specifies Excel 2002.

[<94> Section 2.4.131](#): If two consecutive Gelframe records appear, the second Gelframe is a continuation of the first.

[<95> Section 2.4.131](#): Excel 97 does not save OPT2.

[<96> Section 2.4.133](#): Office Excel 2007 and Excel 2010 uses this **GUID** to determine if the **VBA** project needs to be recompiled on load by comparing the GUID in the file to the GUID built into the application. If the value is 0x0, the VBA project needs to be recompiled on load.

<97> [Section 2.4.150](#): Excel 97, Excel 2000, Excel 2002, Office Excel 2003, Office Excel 2007, and Excel 2010 can save any value from 0 to 0xFF.

<98> [Section 2.4.154](#): This structure is not loaded or saved by Office Excel 2007 and Excel 2010

<99> [Section 2.4.159](#): This structure is not loaded or saved by Office Excel 2007 and Excel 2010.

<100> [Section 2.4.191](#): If the value of the **wPassword** field of the [Password](#) record in the [Globals Substream](#) is not 0x0000, Excel 97, Excel 2000, Excel 2002, Office Excel 2003, Office Excel 2007, and Excel 2010 encrypt the document as specified in [\[MS-OFFCRYPTO\]](#), section 2.3. If an encryption password is not specified or the workbook or sheet is only protected, the document is encrypted with the default password of "\x56\x65\x6C\x76\x65\x74\x53\x77\x65\x61\x74\x73\x68\x6F\x70".

<101> [Section 2.4.196](#): Excel 97 and Excel 2000 do not save this field as part of the record.

<102> [Section 2.4.196](#): Excel 97 and Excel 2000 do not save this field as part of the record.

<103> [Section 2.4.196](#): Excel 97 and Excel 2000 do not save this field as part of the record.

<104> [Section 2.4.206](#): If the value of the **protPwdRev** field of the [Prot4RevPass](#) record is not 0x0000, Excel 97, Excel 2000, Excel 2002, Office Excel 2003, Office Excel 2007, and Excel 2010 encrypt the document as specified in [\[MS-OFFCRYPTO\]](#), section 2.3. If an encryption password is not specified or the workbook or sheet is only protected, the document is encrypted with the default password of "\x56\x65\x6C\x76\x65\x74\x53\x77\x65\x61\x74\x73\x68\x6F\x70".

<105> [Section 2.4.208](#): In the case of Excel 97 this bit specifies whether the **query table** adjusts column width after refresh. If this bit is set to 1 and the **fPreserveFmt** field in the corresponding **dwQsiFuture** field of the [QsiSXTag](#) is set to 1 then the column width is not adjusted after refresh.

<106> [Section 2.4.210](#): Excel 97

<107> [Section 2.4.210](#): Excel 2000

<108> [Section 2.4.210](#): Excel 2002

<109> [Section 2.4.210](#): Office Excel 2003

<110> [Section 2.4.210](#): Office Excel 2007

<111> [Section 2.4.210](#): Excel 2010

<112> [Section 2.4.210](#): Excel 2013

<113> [Section 2.4.216](#): This structure is not loaded or saved by Office Excel 2007 or Excel 2010.

<114> [Section 2.4.218](#): This record was introduced in Office Excel 2007 as a future record type. Consequently, it is preserved in **BIFF8** format, but ignored by Office Excel 2003, Excel 2002, Excel 2000, and Excel 97.

<115> [Section 2.4.241](#): If the **workbook** contains more than 4112 **sheets**, then Excel 97, Excel 2000, Excel 2002, Office Excel 2003, Office Excel 2007, and Excel 2010 can save a file in which any record that references a sheet identifier can reference the wrong sheet.

<116> [Section 2.4.248](#): Office Excel 2007 and Excel 2010 will save at most 512 RefU in the rgraf array of a Selection record. Office Excel 2003, Excel 2002, Excel 2000, and Excel 97 will save at most 1025 RefU in the rgraf array of a Selection record.

<117> [Section 2.4.258](#): This record was introduced in Office Excel 2007 as a Future Record Type. Consequently, it is preserved in BIFF8 format, but ignored by Office Excel 2003, Excel 2002, Excel 2000, and Excel 97.

[<118> Section 2.4.258](#): This **XML** stream is ignored by Office Excel 2003, Excel 2002, Excel 2000, and Excel 97.

[<119> Section 2.4.259](#): Saved only by Office Excel 2007 and Excel 2010.

[<120> Section 2.4.267](#): Excel 97

[<121> Section 2.4.267](#): Excel 2000

[<122> Section 2.4.267](#): Excel 2002

[<123> Section 2.4.267](#): Office Excel 2003

[<124> Section 2.4.267](#): Office Excel 2007

[<125> Section 2.4.267](#): Excel 2010

[<126> Section 2.4.267](#): Excel 2013

[<127> Section 2.4.269](#): Excel 2010, Office Excel 2007, Office Excel 2003, Excel 2002, Excel 2000, and Excel 97 save out an [XLUnicodeString](#) structure with 0 characters.

[<128> Section 2.4.273.9](#): Excel 2000 has a maximum value of 8000. Excel 2002 and Office Excel 2003 have a maximum value of 32500. Values greater than these are treated as these maximums by these applications.

[<129> Section 2.4.273.108](#): In certain circumstances Office Excel 2003, Excel 2002, and Excel 2000 can save out a higher value.

[<130> Section 2.4.281](#): Office Excel 2007 and Excel 2010 can save out **wbe** with a value of 0x2B

[<131> Section 2.4.310](#): Excel 97 does not create this field and ignores it if present.

[<132> Section 2.4.324](#): Excel can write numbers larger than 4000 due to rounding while editing small charts.

[<133> Section 2.4.324](#): Excel can write numbers larger than 4000 due to rounding while editing small charts.

[<134> Section 2.4.324](#): Excel can write numbers larger than 4000 due to rounding while editing small charts.

[<135> Section 2.4.324](#): Excel can write numbers larger than 4000 due to rounding while editing small charts.

[<136> Section 2.4.325](#): This record was introduced in Office Excel 2007 as a Future Record Type. Consequently, it is preserved in BIFF8 format, but ignored by Office Excel 2003, Excel 2002, Excel 2000, and Excel 97.

[<137> Section 2.4.326](#): Excel 97, Excel 2000, Excel 2002, Office Excel 2003, Office Excel 2007, and Excel 2010 can save value 123820, which also indicates default **theme**.

[<138> Section 2.4.329](#): Excel 97, Excel 2000, Excel 2002, Office Excel 2003, Office Excel 2007, and Excel 2010 also use the value "2" to specify justify low alignment. Justify low occurs when Arabic kashida justification is applied to the text. Justify low lengthens kashidas slightly.

[<139> Section 2.4.329](#): Justified alignment is not supported in Office Excel 2007 and Excel 2010 and is treated as middle alignment.

[<140> Section 2.4.329](#): Excel 97 – East Asian version, Excel 2000 – East Asian version, Excel 2002 – East Asian version, Office Excel 2003 – East Asian version, or Office Excel 2007 – East Asian version, or Excel 2010 – East Asian version.

<141> [Section 2.4.335](#): Excel 97, Excel 2000, Excel 2002, and Office Excel 2003 do not set this bit to 1.

<142> [Section 2.4.337](#): Excel 97, Excel 2000, Excel 2002, and Office Excel 2003 can save out a value of 0x0001, indicating that natural language formulas are enabled. This feature is deprecated in Office Excel 2007 and Excel 2010.

<143> [Section 2.4.344](#): Stream does not exist in Excel 97, Excel 2000, Excel 2002, Office Excel 2003, Office Excel 2007, or Excel 2010.

<144> [Section 2.4.346](#): Excel 97, Excel 2000, Excel 2002, Office Excel 2003, Office Excel 2007, and Excel 2010 truncate **wScaleSLV** into a byte when saving.

<145> [Section 2.4.346](#): Excel 97, Excel 2000, Excel 2002, Office Excel 2003, Office Excel 2007, and Excel 2010 truncate **wScaleNormal** into a byte when saving.

<146> [Section 2.4.353](#): If the Transition Navigation Keys option is turned on, the set of prefix characters is single quote, double quote, caret, and backslash, which indicate left-alignment, right-alignment, center-alignment, and fill alignment, respectively. If the Transition Navigation Keys option is turned off, the only possible prefix character is single quote, which has no alignment significance but indicates (like all prefix characters) that the cell contents are to be treated as a string literal.

<147> [Section 2.4.353](#): Excel 97, Excel 2000, Excel 2002, Office Excel 2003, Office Excel 2007, and Excel 2010 can save 0 in this field when **fStyle** equals 1.

<148> [Section 2.5.4](#): Can be 0 if **year** is equal to 1900 and **month** is equal to 1 and the calendar is Gregorian.

<149> [Section 2.5.9](#): Excel 97, Excel 2000, Excel 2002, Office Excel 2003, Office Excel 2007, and Excel 2010 can save XL8_ITBLJAPAN2, XL8_ITBLJAPAN3, XL8_ITBLJAPAN4, and XL8_ITBLNONE_JPN as 0x0000, 0x0001, 0x0002, and 0x0003. In this case, values 0x0000 through 0x0010 are saved as 0x0004 through 0x0014.

<150> [Section 2.5.10](#): Excel 97, Excel 2000, Excel 2002, Office Excel 2003, Office Excel 2007, and Excel 2010 can save bBoolErr with an error value instead of a Boolean value when fError is 0x00.

<151> [Section 2.5.16](#): Excel 97, Excel 2000, Excel 2002, Office Excel 2003, Office Excel 2007, and Excel 2010 save out 0xFF.

<152> [Section 2.5.20](#): Excel 97, Excel 2000, Excel 2002, Office Excel 2003, Office Excel 2007, and Excel 2010 also save out 0 to specify a black background.

<153> [Section 2.5.21](#): The Alpha channel value in the [LongRGBA](#) structure is ignored and set to 0xFF (opaque).

<154> [Section 2.5.27](#): If Office Excel 2007 or Excel 2010 save different values for **cp** in the [CFEx](#) and [CF](#) records, then the value in CFEx takes precedence over the value in CF.

<155> [Section 2.5.32](#): Office Excel 2007 and Excel 2010 will not apply any coloring to a cell when its CFVO value falls outside of the range of the interpolation curve and **fClamp** is not set.

<156> [Section 2.5.60](#): Specifies Excel 97.

<157> [Section 2.5.60](#): Specifies Excel 2000, Excel 2002, Office Excel 2003, Office Excel 2007, or Excel 2010.

<158> [Section 2.5.60](#): Specifies Excel 97.

<159> [Section 2.5.60](#): Specifies Excel 2000.

<160> [Section 2.5.63](#): The following table shows the maximum [data functionality levels](#) that different application versions support:

Value	Maximum data functionality level for
0	Excel 97 and Excel 2000
1	Excel 2002 and Office Excel 2003
3	Office Excel 2007
4	Excel 2010

<161> [Section 2.5.63](#): In Excel 97, Excel 2000, Excel 2002, and Office Excel 2003, the values of some data functionality level fields might not reflect the correct data functionality level.

<162> [Section 2.5.65](#): In the 1900 date system, Excel 97, Excel 2000, Excel 2002, Office Excel 2003, Office Excel 2007, and Excel 2010 treat the year 1900 as though it was a leap year. That is, the value 59 corresponds to February 28, and the value 61 corresponds to March 1, allowing the (non-existent) date February 29 to have the value 60.

<163> [Section 2.5.91](#): Office Excel 2007 and Excel 2010 can save a value greater than 15 and less than 255.

<164> [Section 2.5.113](#): This value is only possible in the context of a [Feature12](#) record, and cannot be written by Office Excel 2003.

<165> [Section 2.5.113](#): Office Excel 2003 does not save the **totalFmla** field; **fLoadTotalFmla** is 0.

<166> [Section 2.5.118](#): This structure only exists in the context of a Feature12 record, and cannot be written by Office Excel 2003.

<167> [Section 2.5.127](#): Excel 97, Excel 2000, Excel 2002, Office Excel 2003, Office Excel 2007, and Excel 2010 can write out values 0x13 through 0x24.

<168> [Section 2.5.129](#): Excel 97, Excel 2000, Excel 2002, Office Excel 2003, Office Excel 2007, and Excel 2010 can save out values 511 through 1022.

<169> [Section 2.5.129](#): These 4 default structures are saved out as identical [Font](#) structures. They are placeholders for their respective font formatting properties.

<170> [Section 2.5.130](#): This value is ignored in Office Excel 2007 and Excel 2010.

<171> [Section 2.5.134](#): The [Feature11](#) and Feature12 records set the **ref8.rwFirst**, **ref8.rwLast**, **ref8.colFirst**, and **ref8.colLast** fields even if **fFrRef** is 0.

<172> [Section 2.5.143](#): Excel 97, Excel 2000, Excel 2002, and Office Excel 2003 all write out a value of 0 for this field and ignore it on load.

<173> [Section 2.5.162](#): Excel 97, Excel 2000, Excel 2002, Office Excel 2003, Office Excel 2007, and Excel 2010 can write out [Icv](#) values 0x0000 and 0x0001. Office Excel 2007 and Excel 2010 can also write out [Icv](#) values that are greater than or equal to 0x0002 and less than or equal to 0x0007.

<174> [Section 2.5.164](#): Excel 97, Excel 2000, Excel 2002, Office Excel 2003, Office Excel 2007, and Excel 2010 can write out [Icv](#) values greater than or equal to 0x01 and less than or equal to 0x07, or the value 0x48, which specifies the system color for text in windows.

<175> [Section 2.5.165](#): Excel 97, Excel 2000, Excel 2002, Office Excel 2003, Office Excel 2007, and Excel 2010 can write values greater than or equal to 0x017F and less than or equal to 0x0188, but they will not be loaded.

<176> [Section 2.5.198.18](#): In Office Excel 2007 and Excel 2010, **natural language formulas** are transformed into **A1** references.

<177> [Section 2.5.198.23](#): Excel 97, Excel 2000, Excel 2002, Office Excel 2003, Office Excel 2007, and Excel 2010 can write out an **rgce** which contain [PtgArray](#).

<178> [Section 2.5.198.104](#): Excel 97, Excel 2000, Excel 2002 and Office Excel 2003 write out these [Ptgs](#). Office Excel 2007 and Excel 2010 convert these Ptgs to equivalent [PtgAreas](#) or [PtgAreaErrs](#) on load and never introduces these Ptgs.

<179> [Section 2.5.203](#): Excel 97, Excel 2000, Excel 2002, Office Excel 2003, Office Excel 2007, and Excel 2010 expect the **cbKey** field in the **PictFmlaKey** structure to be an even value.

<180> [Section 2.5.244](#): ItExternalData is only read and saved by Office Excel 2007 and Excel 2010.

<181> [Section 2.5.248](#): Excel 97, Excel 2000, Excel 2002, Office Excel 2003, Office Excel 2007, and Excel 2010 can save out 0 for certain fonts.

<182> [Section 2.5.248](#): Office Excel 2003, Office Excel 2007, and Excel 2010 can also write out 0.

<183> [Section 2.5.266](#): Office Excel 2003 has unique table identifiers per sheet rather than per workbook. On load, Office Excel 2007 and Excel 2010 reassigns new identifiers if identical ones exist within a same workbook.

<184> [Section 2.5.266](#): Set to 0x1 in case of Web-based **data provider** list **data source** for **worksheets** created using Office Excel 2003.

<185> [Section 2.5.266](#): Office Excel 2007 and Excel 2010 will only write out the value of 1 for this field.

<186> [Section 2.5.266](#): Office Excel 2003 saves 0xB, Office Excel 2007 saves 0xC, Excel 2010 saves 0xE.

<187> [Section 2.5.266](#): Office Excel 2003, Office Excel 2007, and Excel 2010 do not ignore this field.

<188> [Section 2.5.272](#): For files last saved in East Asian versions of the application, **lastRun** can be a [Run](#) instead of a [TxoLastRun](#).

<189> [Section 2.5.282](#): Specifies Office Excel 2007.

<190> [Section 2.5.314](#): Office Excel 2007 and Excel 2010 can save values larger than 500.

<191> [Section 2.5.342](#): Under certain circumstances, Excel 97, Excel 2000, Excel 2002, Office Excel 2003, Office Excel 2007, and Excel 2010 persist these values.

<192> [Section 2.5.344](#): Office Excel 2003, Office Excel 2007, and Excel 2010 can save a value of -1 on the **itabLast** field for either a workbook-level or a sheet-level reference to an [external workbook](#) if an **Information Rights Management (IRM)** authorization failure occurred during a refresh of that workbook's data.

<193> [Section 2.6.2](#): Web-only view is only used by Excel 97, Excel 2000, Excel 2002, and Office Excel 2003.

6 Change Tracking

This section identifies changes that were made to this document since the last release. Changes are classified as Major, Minor, or None.

The revision class **Major** means that the technical content in the document was significantly revised. Major changes affect protocol interoperability or implementation. Examples of major changes are:

- A document revision that incorporates changes to interoperability requirements.
- A document revision that captures changes to protocol functionality.

The revision class **Minor** means that the meaning of the technical content was clarified. Minor changes do not affect protocol interoperability or implementation. Examples of minor changes are updates to clarify ambiguity at the sentence, paragraph, or table level.

The revision class **None** means that no new technical changes were introduced. Minor editorial and formatting changes may have been made, but the relevant technical content is identical to the last released version.

The changes made to this document are listed in the following table. For more information, please contact dochelp@microsoft.com.

Section	Description	Revision class
2.5.33 CFGradientInterpItem	Changed rbct To rgbCT.	Minor
2.5.34 CFGradientItem	Changed rbct To rgbCT.	Minor

7 Index

A

[AddinUdf](#) 587
[ADO recordset connections](#) 163
[AF12CellIcon](#) 587
[AF12Criteria](#) 588
[AF12DateInfo](#) 588
[AFDOper](#) 589
[AFDOperBoolErr](#) 590
[AFDOperRk](#) 591
[AFDOperStr](#) 591
Algorithms
 [Application data for VtHyperlink](#) 923
[AIRuns](#) 191
[Applicability](#) 54
[Application data for VtHyperlink](#) 923
[Area](#) 191
[AreaFormat](#) 192
[Array](#) 197
[ArrayParsedFormula](#) 724
[Attached label](#) 102
[AttachedLabel](#) 198
[AutoFilter](#) 199
[AutoFilter12](#) 201
[AutoFilterInfo](#) 204
[AutoFmt8](#) 592
[AxcExt](#) 204
[AxesUsed](#) 207
Axis ([section 2.2.3.6](#) 88, [section 2.4.11](#) 207)
[axis group](#) 86
[AxisLine](#) 208
[AxisParent](#) 209

B

[Backup](#) 209
[Bar](#) 209
[BCUsrs](#) 210
[Begin](#) 210
[BErr](#) 724
[Bes](#) 593
[BigName](#) 211
[BkHim](#) 211
[Blank](#) 212
[BOF](#) 212
[Bold](#) 594
[BookBool](#) 214
[BookExt](#) 215
[BookExt_Conditional11](#) 594
[BookExt_Conditional12](#) 594
[Boolean](#) 595
[BoolErr](#) 216
[BopPop](#) 216
[BopPopCustom](#) 218
[BorderStyle](#) 595
[BottomMargin](#) 219
[BoundSheet8](#) 220
[BRAI](#) 221
[BuiltInFnGroupCount](#) 222
[BuiltInStyle](#) 596
[Byte ordering](#) 53

C

[CachedDiskHeader](#) 596
[CalcCount](#) 223
[CalcDelta](#) 223
[CalcIter](#) 223
[CalcMode](#) 223
[CalcPrecision](#) 224
[CalcRefMode](#) 224
[CalcSaveRecalc](#) 224
[CatLab](#) 225
[CatSerRange](#) 225
[CbUsr](#) 227
[Cch255](#) 597
[Cell](#) 597
[Cell metadata](#) 104
[Cell table](#) 79
 [retrieval of last-calculated cell values without loading cell table](#) 80
[CellParsedFormula](#) 725
[CellWatch](#) 227
[CellXF](#) 597
[Cetab](#) 725
[CF](#) 228
[CF12](#) 229
[CFCOLOR](#) 601
[CFDatabar](#) 601
[CFEx](#) 232
[CFExAveragesTemplateParams](#) 603
[CFExDateTemplateParams](#) 603
[CFExDefaultTemplateParams](#) 604
[CFExFilterParams](#) 604
[CFExNonCF12](#) 605
[CFExTemplateParams](#) 607
[CFExTextTemplateParams](#) 608
[CFFilter](#) 608
[CFFlag](#) 609
[CFGradient](#) 610
[CFGradientInterpItem](#) 610
[CFGradientItem](#) 611
[CFMStateItem](#) 612
[CFMultistate](#) 612
[CFParsedFormula](#) 754
[CFParsedFormulaNoCCE](#) 754
[CFrtId](#) 613
[CFT](#) 614
[CFVO](#) 615
[CFVOParsedFormula](#) 754
[Change cells revision](#) 168
[Change tracking](#) 1095
Chart ([section 2.1.6.1](#) 58, [section 2.2.3.3](#) 85, [section 2.4.45](#) 233)
[Chart data cache](#) 84
[Chart group](#) 90
[Chart sheet](#) 83
[Chart3d](#) 234
[Chart3DBarShape](#) 236
[ChartFormat](#) 236
[ChartFrtInfo](#) 237
[ChartNumNillable](#) 616

[ChartParsedFormula](#) 755
[Charts](#) 82
 [attached label](#) 102
 [axis](#) 88
 [axis group](#) 86
 [chart](#) 85
 [chart data cache](#) 84
 [chart group](#) 90
 [chart sheet](#) 83
 [data label](#) 94
 [data point](#) 94
 [data table](#) 101
 [error bar](#) 100
 [legend](#) 91
 [pivot chart](#) 86
 [series](#) 93
 [SPRC](#) 103
 [trendline](#) 100
[ClrtClient](#) 238
[CodeName](#) 239
[CodePage](#) 239
[Col](#) 616
[Col_NegativeOne](#) 616
[Col12](#) 617
[Col256U](#) 617
[ColByte](#) 617
[ColByteU](#) 618
[ColElfu](#) 618
[ColInfo](#) 240
[Collection of records](#) 57
[ColorICV](#) 618
[ColorTheme](#) 619
[ColRelNegU](#) 619
[ColRelU](#) 620
[ColSlco8U](#) 620
[ColU](#) 620
[Column Chart Object example](#) 955
[Column chart object: AreaFormat example](#) 958
[Column chart object: AxesUsed example](#) 968
[Column chart object: Axis example](#) 969
[Column chart object: AxisParent example](#) 969
[Column chart object: Bar example](#) 972
[Column chart object: BRAI 1 example](#) 959
[Column chart object: BRAI 2 example](#) 961
[Column chart object: BRAI 3 example](#) 963
[Column chart object: CatSerRange example](#) 969
[Column chart object: Chart example](#) 956
[Column chart object: ChartFormat example](#) 971
[Column chart object: DataFormat example](#) 965
[Column chart object: DefaultText example](#) 966
[Column chart object: FontX example](#) 968
[Column chart object: Frame example](#) 956
[Column chart object: LineFormat example](#) 957
[Column chart object: Series example](#) 959
[Column chart object: SeriesText example](#) 961
[Column chart object: SerToCrt example](#) 965
[Column chart object: ShtProps example](#) 965
[Column chart object: Text example](#) 966
[Column chart object: Tick example](#) 970
[Colx](#) 621
[Compat12](#) 241
[Component object stream](#) 58
[Compound file](#) 56
[CompressPictures](#) 241
[Conceptual overview](#) 79

[cell table](#) 79
[charts](#) 82
[encryption \(password to open\)](#) 164
[external connections](#) 162
[external references](#) 160
[formulas](#) 80
[metadata](#) 103
[password verifier algorithm](#) 163
[PivotTables](#) 106
[shared feature](#) 168
[shared workbooks](#) 165
[styles](#) 157
[CondDataValue](#) 621
[CondFmt](#) 242
[CondFmt12](#) 242
[CondFmtStructure](#) 621
[Conditional Formatting example](#) 924
[Conditional formatting: CF example](#) 926
[Conditional formatting: CondFmt example](#) 924
[Connection files](#) 162
[Connection name](#) 162
[ConnGrbitDbt](#) 622
[ConnGrbitDbtAdo](#) 622
[ConnGrbitDbtOledb](#) 623
[ConnGrbitDbtWeb](#) 624
[Continue](#) 243
[Continue_SxaddlSxString](#) 431
[ContinueBigName](#) 243
[ContinueFrt](#) 244
[ContinueFrt11](#) 244
[ContinueFrt12](#) 245
[Control stream](#) 59
[Control tokens](#) 82
[ControlInfo](#) 625
[Country](#) 245
[CrErr](#) 247
[CRN](#) 247
[CrtLayout12](#) 248
[CrtLayout12A](#) 250
[CrtLayout12Mode](#) 625
[CrtLine](#) 252
[CrtLink](#) 253
[CrtMIFrt](#) 253
[CrtMIFrtContinue](#) 254
[CTB](#) 920
[CTBS](#) 919
[CTBWRAPPER](#) 919
[CUsr](#) 254

D
[DAO recordset connections](#) 163
[Dat](#) 254
[data functionality level](#) 117
[Data label](#) 94
[Data point](#) 94
[Data spaces storage](#) 59
[Data table](#) 101
[DataFormat](#) 255
[DataFunctionalityLevel](#) 626
[DataLabExt \(section 2.4.75](#) 255, [section 2.4.76](#) 256)
[DataSourceType](#) 626
[Date1904](#) 257
[DateAsNum](#) 626
[DateUnit](#) 626

[DBCCell](#) 257
[DbOrParamQry](#) 258
[DbQuery](#) 258
[DbQueryExt](#) 260
[DCol](#) 627
[DColByteU](#) 627
[DCon](#) 262
[DConBin](#) 264
[DConFile](#) 627
[DConn](#) 265
[DConName](#) 270
[DConnConnectionOleDb](#) 628
[DConnConnectionWeb](#) 629
[DConnId](#) 629
[DConnParamBinding](#) 630
[DConnParamBindingValByte](#) 630
[DConnParamBindingValInt](#) 630
[DConnParamBindingValString](#) 630
[DConnParamBindingValType](#) 631
[DConnParameter](#) 631
[DConnStringSequence](#) 632
[DConnUnicodeStringSegmented](#) 632
[DConRef](#) 271
[DDE data item](#) 161
[DDE data source](#) 161
[DefaultRowHeight](#) 272
[DefaultText](#) 272
[DefColWidth](#) 273
[Defined Name example](#) 933
[Defined name: ExternSheet example](#) 935
[Defined name: Lbl example](#) 933
[Defined name: SupBook example](#) 936
Details
[AddinUdf structure](#) 587
[AF12CellIcon structure](#) 587
[AF12Criteria structure](#) 588
[AF12DateInfo structure](#) 588
[AFDOper structure](#) 589
[AFDOperBoolErr structure](#) 590
[AFDOperRk structure](#) 591
[AFDOperStr structure](#) 591
[AlRuns record](#) 191
[Application data for VtHyperlink algorithm](#) 923
[Area record](#) 191
[AreaFormat record](#) 192
[Array record](#) 197
[ArrayParsedFormula structure](#) 724
[AttachedLabel record](#) 198
[AutoFilter record](#) 199
[AutoFilter12 record](#) 201
[AutoFilterInfo record](#) 204
[AutoFmt8 structure](#) 592
[AxcExt record](#) 204
[AxesUsed record](#) 207
[Axis record](#) 207
[AxisLine record](#) 208
[AxisParent record](#) 209
[Backup record](#) 209
[Bar record](#) 209
[BCUsrs record](#) 210
[Begin record](#) 210
[BErr structure](#) 724
[Bes structure](#) 593
[BigName record](#) 211
[BkHim record](#) 211
[Blank record](#) 212
[BOF record](#) 212
[Bold structure](#) 594
[BookBool record](#) 214
[BookExt record](#) 215
[BookExt_Conditional11 structure](#) 594
[BookExt_Conditional12 structure](#) 594
[Boolean structure](#) 595
[BoolErr record](#) 216
[BopPop record](#) 216
[BopPopCustom record](#) 218
[BorderStyle structure](#) 595
[BottomMargin record](#) 219
[BoundSheet8 record](#) 220
[BRAI record](#) 221
[BuiltInFnGroupCount record](#) 222
[BuiltInStyle structure](#) 596
[CachedDiskHeader structure](#) 596
[CalcCount record](#) 223
[CalcDelta record](#) 223
[CalcIter record](#) 223
[CalcMode record](#) 223
[CalcPrecision record](#) 224
[CalcRefMode record](#) 224
[CalcSaveRecalc record](#) 224
[CatLab record](#) 225
[CatSerRange record](#) 225
[CbUsr record](#) 227
[Cch255 structure](#) 597
[Cell structure](#) 597
[CellParsedFormula structure](#) 725
[CellWatch record](#) 227
[CellXF structure](#) 597
[Cetab structure](#) 725
[CF record](#) 228
[CF12 record](#) 229
[CFColor structure](#) 601
[CFDatabar structure](#) 601
[CFEx record](#) 232
[CFExAveragesTemplateParams structure](#) 603
[CFExDateTemplateParams structure](#) 603
[CFExDefaultTemplateParams structure](#) 604
[CFExFilterParams structure](#) 604
[CFExNonCF12 structure](#) 605
[CFExTemplateParams structure](#) 607
[CFExTextTemplateParams structure](#) 608
[CFFilter structure](#) 608
[CFFlag structure](#) 609
[CFGradient structure](#) 610
[CFGradientInterpItem structure](#) 610
[CFGradientItem structure](#) 611
[CFMStateItem structure](#) 612
[CFMultistate structure](#) 612
[CFParsedFormula structure](#) 754
[CFParsedFormulaNoCCE structure](#) 754
[CFrtId structure](#) 613
[CFT structure](#) 614
[CFVO structure](#) 615
[CFVOParsedFormula structure](#) 754
[Chart record](#) 233
[Chart3d record](#) 234
[Chart3DBarShape record](#) 236
[ChartFormat record](#) 236
[ChartFrtInfo record](#) 237
[ChartNumNillable structure](#) 616

[ChartParsedFormula structure](#) 755
[ClrtClient record](#) 238
[CodeName record](#) 239
[CodePage record](#) 239
[Col structure](#) 616
[Col_NegativeOne structure](#) 616
[Col12 structure](#) 617
[Col256U structure](#) 617
[ColByte structure](#) 617
[ColByteU structure](#) 618
[ColElfU structure](#) 618
[ColInfo record](#) 240
[ColorICV structure](#) 618
[ColorTheme structure](#) 619
[ColRelNegU structure](#) 619
[ColRelU structure](#) 620
[ColSico8U structure](#) 620
[ColU structure](#) 620
[Colx structure](#) 621
[Compat12 record](#) 241
[component object stream](#) 58
[CompressPictures record](#) 241
[CondDataValue structure](#) 621
[CondFmt record](#) 242
[CondFmt12 record](#) 242
[CondFmtStructure structure](#) 621
[ConnGrbitDbt structure](#) 622
[ConnGrbitDbtAdo structure](#) 622
[ConnGrbitDbtOledb structure](#) 623
[ConnGrbitDbtWeb structure](#) 624
[Continue record](#) 243
[Continue_SxaddlSxString record](#) 431
[ContinueBigName record](#) 243
[ContinueFrt record](#) 244
[ContinueFrt11 record](#) 244
[ContinueFrt12 record](#) 245
[control stream](#) 59
[ControlInfo structure](#) 625
[Country record](#) 245
[CrErr record](#) 247
[CRN record](#) 247
[CrtLayout12 record](#) 248
[CrtLayout12A record](#) 250
[CrtLayout12Mode structure](#) 625
[CrtLine record](#) 252
[CrtLink record](#) 253
[CrtMIFrt record](#) 253
[CrtMIFrtContinue record](#) 254
[CTB_XCB structure](#) 920
[CTBS_XCB structure](#) 919
[CTBWRAPPER_XCB structure](#) 919
[CUsr record](#) 254
[Dat record](#) 254
[data spaces storage](#) 59
[DataFormat record](#) 255
[DataFunctionalityLevel structure](#) 626
[DataLabExt record \(section 2.4.75 255, section 2.4.76 256\)](#)
[DataSourceType structure](#) 626
[Date1904 record](#) 257
[DateAsNum structure](#) 626
[DateUnit structure](#) 626
[DBCell record](#) 257
[DbOrParamQry record](#) 258
[DbQuery record](#) 258
[DbQueryExt record](#) 260
[DCol structure](#) 627
[DColByteU structure](#) 627
[DCon record](#) 262
[DConBin record](#) 264
[DConFile structure](#) 627
[DConn record](#) 265
[DConName record](#) 270
[DConnConnectionOleDb structure](#) 628
[DConnConnectionWeb structure](#) 629
[DConnId structure](#) 629
[DConnParamBinding structure](#) 630
[DConnParamBindingValByte structure](#) 630
[DConnParamBindingValInt structure](#) 630
[DConnParamBindingValString structure](#) 630
[DConnParamBindingValType structure](#) 631
[DConnParameter structure](#) 631
[DConnStringSequence structure](#) 632
[DConnUnicodeStringSegmented structure](#) 632
[DConRef record](#) 271
[DefaultRowHeight record](#) 272
[DefaultText record](#) 272
[DefColWidth record](#) 273
[Dimensions record](#) 273
[DJoin structure](#) 633
[DocRoute record](#) 274
[document summary information stream](#) 59
[DropBar record](#) 276
[DropDownObjIds record](#) 277
[DRw structure](#) 633
[DRwByteU structure](#) 633
[DSF record](#) 277
[Duce structure](#) 633
[DuceRadical structure](#) 634
[DuceStacked structure](#) 635
[Ducr structure](#) 635
[DucrConditionalLbl structure](#) 636
[DucrConditionalNoLbl structure](#) 637
[Dv record](#) 277
[DVal record](#) 280
[DVParsedFormula structure](#) 755
[DwQsiFuture structure](#) 637
[DXF record](#) 281
[DXFALC structure](#) 638
[DXFBdr structure](#) 639
[DXFFntD structure](#) 640
[DXFId structure](#) 641
[DXFN structure](#) 641
[DXFN12 structure](#) 644
[DXFN12List structure](#) 645
[DXFN12NoCB structure](#) 645
[DXFNum structure](#) 645
[DXFNumIFmt structure](#) 646
[DXFNumUsr structure](#) 646
[DXFPat structure](#) 646
[DXFProt structure](#) 647
[DxGCol record](#) 282
[embedding storage](#) 59
[encryption stream](#) 59
[End record](#) 282
[EndBlock record](#) 282
[EndObject record](#) 284
[EnhancedProtection structure](#) 647
[EntExU2 record](#) 285
[EOF record](#) 285

[Excel9File record](#) 285
[ExternDdeLinkNoOper structure](#) 648
[ExternDocName structure](#) 648
[ExternName record](#) 285
[ExternOleDdeLink structure](#) 649
[ExternSheet record](#) 287
[ExtNameParsedFormula structure](#) 756
[ExtProp structure](#) 649
[ExtPtgArea3D structure](#) 757
[ExtPtgAreaErr3D structure](#) 757
[ExtPtgErr structure](#) 757
[ExtPtgRef3D structure](#) 758
[ExtPtgRefErr3D structure](#) 758
[ExtRst structure](#) 650
[ExtSheetPair structure](#) 758
[ExtSST record](#) 288
[ExtString record](#) 288
[FactoidData structure](#) 651
[Fbi record](#) 289
[Fbi2 record](#) 290
[Feat record](#) 291
[Feat11CellStruct structure](#) 651
[Feat11FdaAutoFilter structure](#) 651
[Feat11FieldDataItem structure](#) 652
[Feat11Fmla structure](#) 659
[Feat11RqInvalidCells structure](#) 659
[Feat11RqSharepointIdChange structure](#) 659
[Feat11RqSharepointIdDel structure](#) 660
[Feat11TotalFmla structure](#) 660
[Feat11WSSListInfo structure](#) 660
[Feat11XMap structure](#) 663
[Feat11XMapEntry structure](#) 663
[Feat11XMapEntry2 structure](#) 664
[FeatFormulaErr2 structure](#) 664
[FeatHdr record](#) 292
[FeatHdr11 record](#) 293
[FeatProtection structure](#) 664
[FeatSmartTag structure](#) 665
[Feature11 record](#) 293
[Feature12 record](#) 295
[FFErrorCheck structure](#) 666
[FileLock record](#) 295
[FilePass record](#) 296
[FileSharing record](#) 297
[FillPattern structure](#) 666
[FillStylePropertiesForShapePropsStreamChecksum structure](#) 667
[FilterMode record](#) 297
[FnGroupName record](#) 297
[FnGrp12 record](#) 297
[Font record](#) 298
[FontIndex structure](#) 677
[FontInfo structure](#) 677
[FontScheme structure](#) 678
[FontX record](#) 300
[Footer record](#) 301
[ForceFullCalculation record](#) 301
[Format record](#) 302
[FormatRun structure](#) 678
[Formula record](#) 309
[FormulaValue structure](#) 678
[Frame record](#) 310
[FrtFlags structure](#) 679
[FrtFontList record](#) 311
[FrtHeader structure](#) 680
[FrtHeaderOld structure](#) 680
[FrtRefHeader structure](#) 680
[FrtRefHeaderNoGrbit structure](#) 681
[FrtRefHeaderU structure](#) 681
[FrtWrapper record](#) 311
[Ftab structure](#) 759
[FtCbIs structure](#) 682
[FtCbIsData structure](#) 682
[FtCf structure](#) 683
[FtCmo structure](#) 683
[FtEdoData structure](#) 686
[FtGboData structure](#) 687
[FtGmo structure](#) 687
[FtLbsData structure](#) 688
[FtMacro structure](#) 690
[FtNts structure](#) 691
[FtPictFmla structure](#) 691
[FtPioGrbit structure](#) 692
[FtRbo structure](#) 694
[FtSbs structure](#) 695
[FullColorExt structure](#) 696
[GelFrame record](#) 312
[GradStop structure](#) 696
[GridSet record](#) 314
[GUIDTypeLib record](#) 314
[Guts record](#) 314
[HCenter record](#) 315
[Header record](#) 315
[HeaderFooter record](#) 319
[HFPicture record](#) 320
[HiddenMemberSet structure](#) 697
[HideObj record](#) 322
[HideObjEnum structure](#) 697
[HLink record](#) 322
[HLinkTooltip record](#) 322
[HorizAlign structure](#) 698
[HorizontalPageBreaks record](#) 323
[HorzBrk structure](#) 698
[Icv structure](#) 698
[IcvChart structure](#) 702
[IcvFont structure](#) 702
[IcvXF structure](#) 702
[IFmt structure](#) 702
[IFmtRecord record](#) 323
[Ilel structure](#) 786
[Index record](#) 323
[InterfaceEnd record](#) 324
[InterfaceHdr record](#) 324
[InteriorColorPropertiesForShapePropsStreamChecksum structure](#) 703
[Intl record](#) 324
[ISSTInf structure](#) 704
[IXFCell structure](#) 704
[KPIProp structure](#) 704
[KPISets structure](#) 705
[Label record](#) 325
[LabelSst record](#) 325
[Lbl record](#) 325
[LbsDropData structure](#) 705
[LeftMargin record](#) 328
[Legend record](#) 328
[LegendException record](#) 329
[Lel record](#) 330
[LEMMode structure](#) 706

[Line record](#) 330
[LineFormat record](#) 331
[LinePropertiesForShapePropsStreamChecksum structure](#) 707
[link storage](#) 59
[list data stream](#) 60
[List12 record](#) 332
[List12BlockLevel structure](#) 708
[List12DisplayName structure](#) 710
[List12TableStyleClientInfo structure](#) 711
[ListParsedArrayFormula structure](#) 787
[ListParsedFormula structure](#) 787
[LongRGB structure](#) 711
[LongRGBA structure](#) 712
[LPr record](#) 333
[LPWideString structure](#) 712
[LRng record](#) 334
[MarkerFormat record](#) 334
[MDB record](#) 336
[MDir structure](#) 712
[MDTInfo record](#) 336
[MDTInfoIndex structure](#) 713
[MDXKPI record](#) 338
[MDXProp record](#) 339
[MDXSet record](#) 339
[MDXStr record](#) 340
[MDXStrIndex structure](#) 713
[MDXTuple record](#) 341
[MergeCells record](#) 341
[Mms record](#) 342
[MOper structure](#) 713
[MsoDrawing record](#) 342
[MsoDrawingGroup record](#) 342
[MsoDrawingSelection record](#) 343
[MTRSettings record](#) 343
[MulBlank record](#) 344
[MulRk record](#) 344
[NameCmt record](#) 345
[NameFnGrp12 record](#) 346
[NameParsedFormula structure](#) 787
[NamePublish record](#) 347
[NilChartNum structure](#) 714
[Note record](#) 347
[NoteRR structure](#) 714
[NoteSh structure](#) 715
[Number record](#) 348
[Obj record](#) 348
[ObjectLink record](#) 351
[ObjectParsedFormula structure](#) 788
[ObjFmla structure](#) ([section 2.5.187](#) 716, [section 2.5.188](#) 717)
[ObjLinkFmla structure](#) 717
[ObjProtect record](#) 351
[ObNoMacros record](#) 352
[ObProj record](#) 352
[ODBCType structure](#) 718
[Office data store storage](#) 64
[Office toolbars stream](#) 64
[OfficeArtClientAnchorChart structure](#) 718
[OfficeArtClientAnchorHF structure](#) 719
[OfficeArtClientAnchorSheet structure](#) 720
[OfficeArtClientData structure](#) 721
[OfficeArtClientTextbox structure](#) 722
[OLE stream](#) 65
[OleDbConn record](#) 352
[OleObjectSize record](#) 353
[Palette record](#) 353
[Pane record](#) 353
[PaneType structure](#) 722
[ParameterParsedFormula structure](#) 788
[ParamQry record](#) 354
[PARAMQRY Fixed structure](#) 723
[Password record](#) 354
[PBT structure](#) 832
[PhoneticInfo record](#) 355
[PhRuns structure](#) 833
[Phs structure](#) 833
[PicF record](#) 355
[PictFmlaEmbedInfo structure](#) 834
[PictFmlaKey structure](#) 834
[Pie record](#) 356
[PieFormat record](#) 357
[pivot cache storage](#) 65
[PivotChartBits record](#) 357
[PivotCompProp structure](#) 835
[PivotParsedFormula structure](#) 789
[PlotArea record](#) 358
[PlotGrowth record](#) 358
[Pls record](#) 358
[PLV record](#) 359
[Pos record](#) 359
[PositionMode structure](#) 835
[PrintGrid record](#) 361
[PrintRowCol record](#) 361
[PrintSize record](#) 362
[Prot4Rev record](#) 362
[Prot4RevPass record](#) 363
[Protect record](#) 363
[protected content stream](#) 65
[Ptg structure](#) 789
[PtgAdd structure](#) 792
[PtgArea structure](#) 792
[PtgArea3d structure](#) 793
[PtgAreaErr structure](#) 793
[PtgAreaErr3d structure](#) ([section 2.5.198.30](#) 794, [section 2.5.198.31](#) 794)
[PtgArray structure](#) 795
[PtgAttrBaxcel structure](#) 795
[PtgAttrChoose structure](#) 796
[PtgAttrGoto structure](#) 796
[PtgAttrIf structure](#) 797
[PtgAttrSemi structure](#) 797
[PtgAttrSpace structure](#) 797
[PtgAttrSpaceSemi structure](#) 798
[PtgAttrSpaceType structure](#) 798
[PtgAttrSum structure](#) 799
[PtgBool structure](#) 799
[PtgConcat structure](#) 799
[PtgDataType structure](#) 799
[PtgDiv structure](#) 800
[PtgElfCol structure](#) 800
[PtgElfColS structure](#) 800
[PtgElfColSV structure](#) 801
[PtgElfColV structure](#) 801
[PtgElfLel structure](#) 801
[PtgElfRadical structure](#) 802
[PtgElfRadicalLel structure](#) 802
[PtgElfRadicalS structure](#) 803
[PtgElfRw structure](#) 803
[PtgElfRwV structure](#) 804

[PtgEq structure](#) 804
[PtgErr structure](#) 804
[PtgExp structure](#) 804
[PtgExtraArray structure](#) 805
[PtgExtraElf structure](#) 805
[PtgExtraMem structure](#) 806
[PtgFunc structure](#) 806
[PtgFuncVar structure](#) 806
[PtgGe structure](#) 807
[PtgGt structure](#) 807
[PtgInt structure](#) 807
[PtgIsect structure](#) 808
[PtgLe structure](#) 808
[PtgLt structure](#) 808
[PtgMemArea structure](#) 808
[PtgMemErr structure](#) 809
[PtgMemFunc structure](#) 809
[PtgMemNoMem structure](#) 810
[PtgMissArg structure](#) 810
[PtgMul structure](#) 810
[PtgName structure](#) 811
[PtgNameX structure](#) 811
[PtgNe structure](#) 812
[PtgNum structure](#) 812
[PtgParen structure](#) 812
[PtgPercent structure](#) 813
[PtgPower structure](#) 813
[PtgRange structure](#) 813
[PtgRef structure](#) 813
[PtgRef3d structure](#) 814
[PtgRefErr structure](#) 814
[PtgRefErr3d structure](#) 815
[PtgRefN structure](#) 815
[PtgStr structure](#) 815
[PtgSub structure](#) 816
[PtgSxName structure](#) 816
[PtgTbl structure](#) 816
[PtgUminus structure](#) 817
[PtgUnion structure](#) 817
[PtgUplus structure](#) 817
[Qsi record](#) 363
[Qsif record](#) 366
[Qsir record](#) 367
[QsiSXTag record](#) 369
[Radar record](#) 371
[RadarArea record](#) 371
[ReadingOrder structure](#) 835
[RealTimeData record](#) 372
[RecalcId record](#) 373
[RecipName record](#) 373
[Ref structure](#) 836
[Ref8 structure](#) 836
[Ref8U structure](#) 837
[Ref8U2007 structure](#) 837
[RefreshAll record](#) 374
[RefU structure](#) 838
[RevExtern structure](#) 818
[revision stream](#) 65
[RevisionType structure](#) 838
[RevItab structure](#) 818
[RevLblName structure](#) 819
[RevName structure](#) 820
[RevNamePly structure](#) 821
[RevNameTabId structure](#) 821
[RevSheetName structure](#) 821
[RFX structure](#) 839
[RgbExtra structure](#) 822
[Rqce structure](#) 823
[RqceArea structure](#) 826
[RqceAreaRel structure](#) 827
[RqceElfLoc structure](#) 827
[RqceElfLocExtra structure](#) 828
[RqceLoc structure](#) 828
[RqceLoc8 structure](#) 828
[RqceLocRel structure](#) 828
[RichTextStream record](#) 374
[RichTextStreamChecksumData structure](#) 839
[RichTextStreamChecksumFontInformation structure](#) 841

[RichTextStreamChecksumFontInformationArrayItem structure](#) 843
[RightMargin record](#) 376
[RK record](#) 376
[RkNumber structure](#) 843
[RkRec structure](#) 844
[Row record](#) 377
[RPHSSub structure](#) 844
[RRAutoFmt record](#) 378
[RRD structure](#) 845
[RRDChgCell record](#) 379
[RRDConflict record](#) 383
[RRDDefName record](#) 384
[RRDDefNameFlags structure](#) 845
[RRDHead record](#) 386
[RRDInfo record](#) 388
[RRDInsDel record](#) 389
[RRDInsDelBegin record](#) 390
[RRDInsDelEnd record](#) 390
[RRDMove record](#) 390
[RRDMoveBegin record](#) 391
[RRDMoveEnd record](#) 391
[RRDRenSheet record](#) 391
[RRDRstEtxp record](#) 392
[RRDTQSIF record](#) 393
[RRDUserView record](#) 394
[RRFormat record](#) 395
[RRInsertSh record](#) 395
[RRLoc structure](#) 847
[RRSort record](#) 396
[RRTabId record](#) 397
[RTDEItem structure](#) 847
[RTDOper structure](#) 847
[RTDOperStr structure](#) 848
[Run structure](#) 848
[Rw structure](#) 848
[Rw12 structure](#) 849
[RwLongU structure](#) 849
[RwU structure](#) 849
[Rwx structure](#) 849
[SBaseRef record](#) 397
[Scatter record](#) 398
[SCENARIO record](#) 399
[ScenarioProtect record](#) 400
[ScenMan record](#) 400
[Scl record](#) 401
[Script structure](#) 850
[SD_SetSortOrder structure](#) 850
[SDContainer structure](#) 850
[SecurityDescriptor structure](#) 851

[Selection record](#) 401
[SerAr structure](#) 829
[SerAuxErrBar record](#) 402
[SerAuxTrend record](#) 403
[SerBool structure](#) 829
[SerErr structure](#) 830
[SerFmt record](#) 404
[Series record](#) 405
[SeriesList record](#) 406
[SeriesText record](#) 406
[SerNil structure](#) 830
[SerNum structure](#) 830
[SerParent record](#) 406
[SerStr structure](#) 831
[SerToCrt record](#) 407
[Setup record](#) 407
[ShapePropsStream record](#) 412
[ShapePropsStreamChecksumData structure](#) 851
[SharedFeatureType structure](#) 852
[SharedParsedFormula structure](#) 831
[SheetExt record](#) 413
[SheetExtOptional structure](#) 853
[ShortDTR structure](#) 854
[ShortXLUnicodeString structure](#) 854
[ShrFmla record](#) 414
[ShtProps record](#) 414
[signatures stream](#) 66
[SIIndex record](#) 415
[SLCO8 structure](#) 855
[Sort record](#) 416
[SortCond12 structure](#) 855
[SortData record](#) 417
[SortItem structure](#) 856
[SourceType structure](#) 857
[SQElfFlags structure](#) 857
[SqRef structure](#) 857
[SqRefU structure](#) 858
[SST record](#) 419
[StartBlock record](#) 420
[StartObject record](#) 425
[String record](#) 426
[structure](#) 694
[Stxp structure](#) 858
[Style record](#) 426
[StyleExt record](#) 427
[StyleXF structure](#) 859
[summary information stream](#) 66
[SupBook record](#) 428
[Surf record](#) 430
[SXAddl record](#) 431
[SXAddl SXCAutoSort SXDEnd record](#) 432
[SXAddl SXCAutoSort SXDIId record](#) 432
[SXAddl SXCCache SXDEnd record](#) 433
[SXAddl SXCCache SXDIId record](#) 433
[SXAddl SXCCache SXDIInfo12 record](#) 433
[SXAddl SXCCache SXDIInvRefreshReal record](#) 434
[SXAddl SXCCache SXDVer10Info record](#) 434
[SXAddl SXCCache SXDVerSxMacro record](#) 435
[SXAddl SXCCache SXDVerUpdInv record](#) 436
[SXAddl SXCCacheField SXDCaption record](#) 436
[SXAddl SXCCacheField SXDEnd record](#) 436
[SXAddl SXCCacheField SXDIId record](#) 437
[SXAddl SXCCacheField SXDIfdbMempropMap record](#) 437

[SXAddl SXCCacheField SXDIfdbMpMapCount record](#) 438
[SXAddl SXCCacheField SXDProperty record](#) 438
[SXAddl SXCCacheField SXDPropName record](#) 439
[SXAddl SXCCacheField SXDSxmitmCount record](#) 439
[SXAddl SXCCacheItem SXDEnd record](#) 440
[SXAddl SXCCacheItem SXDIId record](#) 440
[SXAddl SXCCacheItem SXDIItmMpMapCount record](#) 440
[SXAddl SXCCacheItem SXDIItmMpropMap record](#) 441
[SXAddl SXCCacheItem SXDSxmitmDisp record](#) 441
[SXAddl SXCFIELD SXDEnd record](#) 442
[SXAddl SXCFIELD SXDIId record](#) 442
[SXAddl SXCFIELD SXDVer10Info record](#) 442
[SXAddl SXCFIELD12 SXDAutoshow record](#) 443
[SXAddl SXCFIELD12 SXDEnd record](#) 443
[SXAddl SXCFIELD12 SXDIId record](#) 444
[SXAddl SXCFIELD12 SXDISXTH record](#) 444
[SXAddl SXCFIELD12 SXDMemberCaption record](#) 445
[SXAddl SXCFIELD12 SXDVer12Info record](#) 445
[SXAddl SXCFIELD12 SXDVerUpdInv record](#) 446
[SXAddl SXCGroup SXDEnd record](#) 446
[SXAddl SXCGroup SXDGrpInfo record](#) 447
[SXAddl SXCGroup SXDIId record](#) 448
[SXAddl SXCGroup SXDMember record](#) 448
[SXAddl SXCGrpLevel SXDEnd record](#) 449
[SXAddl SXCGrpLevel SXDGrpLevelInfo record](#) 449
[SXAddl SXCGrpLevel SXDIId record](#) 450
[SXAddl SXCHierarchy SXDDisplayFolder record](#) 450
[SXAddl SXCHierarchy SXDEnd record](#) 451
[SXAddl SXCHierarchy SXDFilterMember record](#) 451
[SXAddl SXCHierarchy SXDFilterMember12 record](#) 452
[SXAddl SXCHierarchy SXDIIconSet record](#) 453
[SXAddl SXCHierarchy SXDIId record](#) 453
[SXAddl SXCHierarchy SXDIInfo12 record](#) 454
[SXAddl SXCHierarchy SXDKPIGoal record](#) 455
[SXAddl SXCHierarchy SXDKPIStatus record](#) 455
[SXAddl SXCHierarchy SXDKPITime record](#) 455
[SXAddl SXCHierarchy SXDKPITrend record](#) 456
[SXAddl SXCHierarchy SXDKPIValue record](#) 456
[SXAddl SXCHierarchy SXDKPIWeight record](#) 457
[SXAddl SXCHierarchy SXDMeasureGrp record](#) 457
[SXAddl SXCHierarchy SXDParentKPI record](#) 458
[SXAddl SXCHierarchy SXDProperty record](#) 458
[SXAddl SXCHierarchy SXDSXSetParentUnique record](#) 460
[SXAddl SXCHierarchy SXDUserCaption record](#) 460
[SXAddl SXCHierarchy SXDVerUpdInv record](#) 460
[SXAddl SXCQsi SXDEnd record](#) 461
[SXAddl SXCQsi SXDIId record](#) 461
[SXAddl SXCQuery SXDEnd record](#) 461
[SXAddl SXCQuery SXDRReconnCond record](#) 462
[SXAddl SXCQuery SXDSrcConnFile record](#) 463
[SXAddl SXCQuery SXDSrcDataFile record](#) 463
[SXAddl SXCQuery SXDXMLSource record](#) 463
[SXAddl SXCSXCondFmt SXDEnd record](#) 464
[SXAddl SXCSXCondFmt SXDSXCondFmt record](#) 464

[SXAddl SXCSXCondFmts SXDEnd record](#) 465
[SXAddl SXCSXCondFmts SXDIId record](#) 466
[SXAddl SXCSXDH SXDEnd record](#) 466
[SXAddl SXCSXDH SXDIId record](#) 467
[SXAddl SXCSXDH SXDSxdh record](#) 467
[SXAddl SXCSXfilt SXDEnd record](#) 468
[SXAddl SXCSXfilt SXDIId record](#) 469
[SXAddl SXCSXfilt SXDSXfilt record](#) 469
[SXAddl SXCSXfilt SXDSXitm record](#) 470
[SXAddl SXCSXFilter12 SXDCaption record](#) 471
[SXAddl SXCSXFilter12 SXDEnd record](#) 472
[SXAddl SXCSXFilter12 SXDIId record](#) 472
[SXAddl SXCSXFilter12 SXDSXFilter record](#) 472
[SXAddl SXCSXFilter12 SXDSXFilterDesc record](#)
474
[SXAddl SXCSXFilter12 SXDSXFilterValue1 record](#)
474
[SXAddl SXCSXFilter12 SXDSXFilterValue2 record](#)
474
[SXAddl SXCSXFilter12 SXDXIsFilter record](#) 475
[SXAddl SXCSXFilter12 SXDXIsFilterValue1 record](#)
475
[SXAddl SXCSXFilter12 SXDXIsFilterValue2 record](#)
476
[SXAddl SXCSXFilters12 SXDEnd record](#) 476
[SXAddl SXCSXFilters12 SXDIId record](#) 477
[SXAddl SXCSXMg SXDEnd record](#) 477
[SXAddl SXCSXMg SXDIId record](#) 477
[SXAddl SXCSXMg SXDUserCaption record](#) 478
[SXAddl SXCSXMgs SXDEnd record](#) 478
[SXAddl SXCSXMgs SXDIId record](#) 478
[SXAddl SXCSXMgs SXDMGrpSXDHMap record](#) 479
[SXAddl SXCSXrule SXDEnd record](#) 480
[SXAddl SXCSXrule SXDIId record](#) 480
[SXAddl SXCSXrule SXDSXrule record](#) 480
[SXAddl SXCView SXDCalcMember record](#) 483
[SXAddl SXCView SXDCalcMemString record](#) 485
[SXAddl SXCView SXDCompactColHdr record](#) 485
[SXAddl SXCView SXDCompactRwHdr record](#) 486
[SXAddl SXCView SXDEnd record](#) 486
[SXAddl SXCView SXDIId record](#) 487
[SXAddl SXCView SXDSXPIIvmb record](#) 487
[SXAddl SXCView SXDTableStyleClient record](#) 488
[SXAddl SXCView SXDVer10Info record](#) 488
[SXAddl SXCView SXDVer12Info record](#) 490
[SXAddl SXCView SXDVerUpdInv record](#) 492
[SxAddl SXDEnd structure](#) 861
[SxAddl SXDVerUpdInv structure](#) 861
[SxAddl SXString structure](#) 861
[SXAddlHdr structure](#) 862
[SXAxis structure](#) 862
[SxBool record](#) 493
[SXDB record](#) 493
[SXDBB record](#) 494
[SXDBEx record](#) 494
[SXDI record](#) 495
[SXDtr record](#) 497
[SxDXF record](#) 497
[SxErr record](#) 498
[SXEx record](#) 498
[SXEZDoper structure](#) 862
[SXFDB record](#) 501
[SXFDBType record](#) 504
[SxFilt record](#) 504
[SxFmla record](#) 505
[SxFormat record](#) 506
[SxFormula record](#) 506
[SxFT structure](#) 863
[SxInt record](#) 506
[SxIsxoper record](#) 507
[SxItm record](#) 507
[SxIvd record](#) 508
[SxIvdCol structure](#) 867
[SxIvdRw structure](#) 867
[SxLI record](#) 509
[SxLIItem structure](#) 867
[SxName record](#) 509
[SxNil record](#) 510
[SXNum record](#) 510
[SXPair record](#) 510
[SXPI record](#) 511
[SXPI Item structure](#) 870
[SXPIEx record](#) 512
[SXRng record](#) 512
[SxRule record](#) 514
[SxSelect record](#) 516
[SXStreamID record](#) 518
[SXString record](#) 518
[SXTbl record](#) 518
[SxTbpg record](#) 519
[SXTBRGIITM record](#) 520
[SxTH record](#) 520
[Sxvd record](#) 523
[SXVDEx record](#) 527
[SXVDEx Opt structure](#) 870
[SXVDTEx record](#) 530
[SXVI record](#) 531
[SxView record](#) 533
[SxView9Save structure](#) 871
[SxViewEx record](#) 535
[SxViewEx9 record](#) 536
[SxViewLink record](#) 537
[SXVIFlags structure](#) 871
[SXVS record](#) 538
[Sync record](#) 538
[TabId structure](#) 872
[TabIndex structure](#) 872
[Table record](#) 538
[TableFeatureType structure](#) 872
[TableStyle record](#) 540
[TableStyleElement record](#) 541
[TableStyles record](#) 544
[Tag Fn MDX structure](#) 876
[TBC XCB structure](#) 921
[TBCCmd XCB structure](#) 922
[Template record](#) 545
[Text record](#) 545
[TextPropsStream record](#) 550
[TextPropsStreamChecksumData structure](#) 877
[Theme record](#) 552
[Tick record](#) 552
[Top10FT structure](#) 879
[TopMargin record](#) 555
[Ts structure](#) 879
[TxO record](#) 556
[TxOLastRun structure](#) 879
[TxORuns structure](#) 880
[TxtQry record](#) 558
[TxtWf structure](#) 880
[Uncalced record](#) 560

[Underline structure](#) 881
[Units record](#) 560
[user_names_stream](#) 67
[UserBView record](#) 560
[UserSViewBegin record](#) 564
[UserSViewBegin_Chart record](#) 567
[UserSViewEnd record](#) 569
[UsesELFs record](#) 569
[UsrChk record](#) 569
[UsrExcl record](#) 570
[UsrInfo record](#) 571
[ValueRange record](#) 571
[VBA storage](#) 67
[VCenter record](#) 574
[VertAlign structure](#) 881
[VertBrk structure](#) 881
[VerticalPageBreaks record](#) 574
[viewer_content_stream](#) 67
[VirtualPath structure](#) 881
[WebPub record](#) 574
[WebPubString structure](#) 883
[Window1 record](#) 577
[Window2 record](#) 578
[WinProtect record](#) 580
[WOpt record](#) 581
[workbook_stream](#) 67
[WriteAccess record](#) 582
[WriteProtect record](#) 583
[WsBool record](#) 583
[XColorType structure](#) 884
[XCT record](#) 584
[XF record](#) 584
[XFCRC record](#) 585
[XFExt record](#) 585
[XFExtGradient structure](#) 884
[XFExtNoFRT structure](#) 885
[XFIndex structure](#) 885
[XFProp structure](#) 887
[XFPropBorder structure](#) 889
[XFPropColor structure](#) 889
[XFPropGradient structure](#) 890
[XFPropGradientStop structure](#) 891
[XFProps structure](#) 891
[XFPropTextRotation structure](#) 892
[XLNameUnicodeString structure](#) 892
[XlsFilter_Criteria structure](#) 893
[XlsFilter_Top10 structure](#) 894
[XLUnicodeRichExtendedString structure](#) 895
[XLUnicodeString structure](#) 896
[XLUnicodeStringMin2 structure](#) 897
[XLUnicodeStringNoCch structure](#) 897
[XLUnicodeStringSegmented structure](#) 897
[XLUnicodeStringSegmentedRTD structure](#) 898
[XLUnicodeStringSegmentedSXAddl structure](#) 898
[XML signatures storage](#) 75
[XML stream](#) 75
[XmlTkBackWallThicknessFrt structure](#) 899
[XmlTkBaseTimeUnitFrt structure](#) 899
[XmlTkBlob structure](#) 900
[XmlTkBool structure](#) 900
[XmlTkChain structure](#) 901
[XmlTkColorMappingOverride structure](#) 903
[XmlTkDispBlanksAsFrt structure](#) 903
[XmlTkDouble structure](#) 904
[XmlTkDWord structure](#) 904
[XmlTkEnd structure](#) 905
[XmlTkEndSurface structure](#) 905
[XmlTkFloorThicknessFrt structure](#) 905
[XmlTkFormatCodeFrt structure](#) 906
[XmlTkHeader structure](#) 906
[XmlTkHeightPercent structure](#) 906
[XmlTkLogBaseFrt structure](#) 907
[XmlTkMajorUnitFrt structure](#) 907
[XmlTkMajorUnitTypeFrt structure](#) 907
[XmlTkMaxFrt structure](#) 908
[XmlTkMinFrt structure](#) 908
[XmlTkMinorUnitFrt structure](#) 909
[XmlTkMinorUnitTypeFrt structure](#) 909
[XmlTkNoMultiLvlLbl structure](#) 910
[XmlTkOverlay structure](#) 910
[XmlTkPerspectiveFrt structure](#) 911
[XmlTkPieComboFrom12Frt structure](#) 911
[XmlTkRAngAxOffFrt structure](#) 911
[XmlTkRotXFrt structure](#) 912
[XmlTkRotYFrt structure](#) 912
[XmlTkShowDLblsOverMax structure](#) 912
[XmlTkSpb structure](#) 913
[XmlTkStart structure](#) 913
[XmlTkStartSurface structure](#) 913
[XmlTkString structure](#) 914
[XmlTkStyle structure](#) 914
[XmlTkSymbolFrt structure](#) 914
[XmlTkThemeOverride structure](#) 915
[XmlTkTickLabelPositionFrt structure](#) 915
[XmlTkTickLabelSkipFrt structure](#) 916
[XmlTkTickMarkSkipFrt structure](#) 916
[XmlTkToken structure](#) 916
[XmlTkTpb structure](#) 917
[Xnum structure](#) 917
[XORObfuscation structure](#) 917
[XTI structure](#) 917
[XtiIndexstructure](#) 832
[YMult record](#) 586
[Differential formatting \(DXFs\)](#) 158
[Dimensions](#) 273
[Display tokens](#) 82
[DJoin](#) 633
[DocRoute](#) 274
[Document_summary_information_stream](#) 59
[DropBar](#) 276
[DropDownObjIds](#) 277
[DRw](#) 633
[DRwByteU](#) 633
[DSF](#) 277
[Duce](#) 633
[DuceRadical](#) 634
[DuceStacked](#) 635
[Ducr](#) 635
[DucrConditionalLbl](#) 636
[DucrConditionalNoLbl](#) 637
[Dv](#) 277
[DVal](#) 280
[DVParsedFormula](#) 755
[DwOsiFuture](#) 637
[DXF](#) 281
[DXFALC](#) 638
[DXFBdr](#) 639
[DXFFntD](#) 640
[DXFId](#) 641
[DXFN](#) 641

[DXFN12](#) 644
[DXFN12List](#) 645
[DXFN12NoCB](#) 645
[DXFNum](#) 645
[DXFNumIFmt](#) 646
[DXFNumUsr](#) 646
[DXFPat](#) 646
[DXFProt](#) 647
[DXFs \(differential formatting\)](#) 158
[DxGCol](#) 282

E

[Embedding storage](#) 59
[Encryption \(password to open\)](#) 164
[Encryption stream](#) 59
[End](#) 282
[EndBlock](#) 282
[EndObject](#) 284
[EnhancedProtection](#) 647
[EntExU2](#) 285
[EOF](#) 285
[Error bar](#) 100
[Examples](#) 924
 [Column Chart Object](#) 955
 [column chart object: AreaFormat](#) 958
 [column chart object: AxesUsed](#) 968
 [column chart object: Axis](#) 969
 [column chart object: AxisParent](#) 969
 [column chart object: Bar](#) 972
 [column chart object: BRAI 1](#) 959
 [column chart object: BRAI 2](#) 961
 [column chart object: BRAI 3](#) 963
 [column chart object: CatSerRange](#) 969
 [column chart object: Chart](#) 956
 [column chart object: ChartFormat](#) 971
 [column chart object: DataFormat](#) 965
 [column chart object: DefaultText](#) 966
 [column chart object: FontX](#) 968
 [column chart object: Frame](#) 956
 [column chart object: LineFormat](#) 957
 [column chart object: Series](#) 959
 [column chart object: SeriesText](#) 961
 [column chart object: SerToCrt](#) 965
 [column chart object: ShtProps](#) 965
 [column chart object: Text](#) 966
 [column chart object: Tick](#) 970
 [Conditional Formatting](#) 924
 [conditional formatting: CF](#) 926
 [conditional formatting: CondFmt](#) 924
 [Defined Name](#) 933
 [defined name: ExternSheet](#) 935
 [defined name: Lbl](#) 933
 [defined name: SupBook](#) 936
 [External References](#) 948
 [external references: CRN](#) 953
 [external references: ExternSheet](#) 954
 [external references: Formula](#) 949
 [external references: String](#) 951
 [external references: SupBook 1](#) 952
 [external references: SupBook 2](#) 954
 [external references: XCT](#) 952
 [Filters](#) 946
 [filters: AutoFilter](#) 947
 [filters: AutoFilterInfo](#) 947

[filters: FilterMode](#) 946
[Formatting](#) 981
 [formatting: Font 1](#) 982
 [formatting: Font 2](#) 983
 [formatting: Format](#) 984
 [formatting: Number 1](#) 993
 [formatting: Number 2](#) 994
 [formatting: Number 3](#) 995
 [formatting: XF 1](#) 985
 [formatting: XF 2](#) 987
 [formatting: XF 3](#) 989
 [formatting: XF 4](#) 991
 [Pie Chart Sheet](#) 973
 [pie chart sheet: AxesUsed](#) 974
 [pie chart sheet: AxisParent](#) 975
 [pie chart sheet: BRAI](#) 980
 [pie chart sheet: Chart](#) 973
 [pie chart sheet: ChartFormat](#) 975
 [pie chart sheet: Legend](#) 976
 [pie chart sheet: Pie](#) 975
 [pie chart sheet: Pos](#) 977
 [pie chart sheet: PrintSize](#) 973
 [pie chart sheet: ShtProps](#) 974
 [pie chart sheet: Text](#) 978
 [pie chart sheet: Window2](#) 980
 [PivotTable](#) 1030
 [PivotTable: DConRef](#) 1032
 [PivotTable: EOF](#) 1083
 [PivotTable: QsiSXTag](#) 1065
 [PivotTable: SXAddl 1](#) 1033
 [PivotTable: SXAddl 2](#) 1034
 [PivotTable: SXAddl 3](#) 1035
 [PivotTable: SxAddl 4](#) 1067
 [PivotTable: SxAddl 5](#) 1068
 [PivotTable: SxAddl 6](#) 1070
 [PivotTable: SXDB](#) 1070
 [PivotTable: SXDBB 1](#) 1081
 [PivotTable: SXDBB 2](#) 1082
 [PivotTable: SXDBEx](#) 1072
 [PivotTable: SXDI](#) 1056
 [PivotTable: SXDtr 1](#) 1076
 [PivotTable: SXDtr 2](#) 1076
 [PivotTable: SXEx](#) 1063
 [PivotTable: SXFDB 1](#) 1072
 [PivotTable: SXFDB 2](#) 1075
 [PivotTable: SXFDB 3](#) 1077
 [PivotTable: SXFDB 4](#) 1078
 [PivotTable: SXFDB 5](#) 1080
 [PivotTable: SxIvd](#) 1055
 [PivotTable: SXLI 1](#) 1056
 [PivotTable: SXLI 2](#) 1062
 [PivotTable: SXNum 1](#) 1079
 [PivotTable: SXNum 2](#) 1081
 [PivotTable: SXNum 3](#) 1082
 [PivotTable: SXPI](#) 1055
 [PivotTable: SXStreamID](#) 1031
 [PivotTable: SXString 1](#) 1074
 [PivotTable: SXString 2](#) 1074
 [PivotTable: SXString 3](#) 1074
 [PivotTable: Sxvd 1](#) 1039
 [PivotTable: Sxvd 2](#) 1044
 [PivotTable: Sxvd 3](#) 1048
 [PivotTable: Sxvd 4](#) 1049
 [PivotTable: Sxvd 5](#) 1052
 [PivotTable: SXVDEx 1](#) 1043

[PivotTable: SXVDEx 2](#) 1047
[PivotTable: SXVDEx 3](#) 1051
[PivotTable: SXVDEx 4](#) 1053
[PivotTable: SXVI 1](#) 1040
[PivotTable: SXVI 2](#) 1041
[PivotTable: SXVI 3](#) 1041
[PivotTable: SXVI 4](#) 1042
[PivotTable: SXVI 5](#) 1046
[PivotTable: SXVI 6](#) 1046
[PivotTable: SXVI 7](#) 1047
[PivotTable: SxView](#) 1035
[PivotTable: SXViewEx9](#) 1067
[PivotTable: SXVS](#) 1031
[Table](#) 936
[table: Feathdr11](#) 936
[table: Feature11](#) 937
[Workbook](#) 995
[workbook: BOF 1](#) 996
[workbook: BookBool](#) 1000
[workbook: BookExt](#) 1009
[workbook: BoundSheet8 1](#) 1006
[workbook: BoundSheet8 2](#) 1006
[workbook: BoundSheet8 3](#) 1007
[workbook: BuiltInFnGroupCount](#) 998
[workbook: CalcPrecision](#) 1000
[workbook: Country](#) 1007
[workbook: Date1904](#) 1000
[workbook: DBCell](#) 1026
[workbook: DefaultRowHeight](#) 1013
[workbook: DefColWidth](#) 1016
[workbook: Dimensions](#) 1016
[workbook: EOF 1](#) 1011
[workbook: EOF 2](#) ([section 3.9.22](#) 1011, [section 3.9.41](#) 1030)
[workbook: ExtSST](#) 1008
[workbook: Font](#) 1001
[workbook: Format](#) 1002
[workbook: Formula](#) 1023
[workbook: HideObj](#) 1000
[workbook: Index](#) 1012
[workbook: LabelSst 1](#) 1020
[workbook: LabelSst 2](#) 1022
[workbook: PhoneticInfo](#) 1029
[workbook: RecalcId](#) 1008
[workbook: RK](#) 1021
[workbook: Row 1](#) 1017
[workbook: Row 2](#) 1018
[workbook: Row 3](#) 1019
[workbook: Row 4](#) 1019
[workbook: RRTabId](#) 997
[workbook: Selection](#) 1028
[workbook: Setup](#) 1014
[workbook: SST](#) 1008
[workbook: Style](#) 1005
[workbook: Window1](#) 998
[workbook: Window2](#) 1026
[workbook: WsBool](#) 1013
[workbook: XF](#) 1003
[Excel9File](#) 285
[External cell cache](#) 161
[External connections](#) 162
[ADO recordset connections](#) 163
[connection files](#) 162
[connection name](#) 162
[DAO recordset connections](#) 163
[ODBC connections](#) 163
[OLE DB connections](#) 162
[text import connections](#) 163
[web connections](#) 163
[External defined name](#) 161
[External reference consumers](#) 160
[External references](#) 160
[DDE data item](#) 161
[DDE data source](#) 161
[external cell cache](#) 161
[external defined name](#) 161
[external reference consumers](#) 160
[external workbook](#) 161
[OLE data item](#) 161
[OLE data source](#) 161
[supporting link](#) 160
[External References example](#) 948
[External references: CRN example](#) 953
[External references: ExternSheet example](#) 954
[External references: Formula example](#) 949
[External references: String example](#) 951
[External references: SupBook 1 example](#) 952
[External references: SupBook 2 example](#) 954
[External references: XCT example](#) 952
[External workbook](#) 161
[ExternDdeLinkNoOper](#) 648
[ExternDocName](#) 648
[ExternName](#) 285
[ExternOleDdeLink](#) 649
[ExternSheet](#) 287
[ExtNameParsedFormula](#) 756
[ExtProp](#) 649
[ExtPtgArea3D](#) 757
[ExtPtgAreaErr3D](#) 757
[ExtPtgErr](#) 757
[ExtPtgRef3D](#) 758
[ExtPtgRefErr3D](#) 758
[ExtRst](#) 650
[ExtSheetPair](#) 758
[ExtSST](#) 288
[ExtString](#) 288

F

[FactoidData](#) 651
[Fbi](#) 289
[Fbi2](#) 290
[Feat](#) 291
[Feat11CellStruct](#) 651
[Feat11FdaAutoFilter](#) 651
[Feat11FieldDataItem](#) 652
[Feat11Fmla](#) 659
[Feat11RqInvalidCells](#) 659
[Feat11RqSharepointIdChange](#) 659
[Feat11RqSharepointIdDel](#) 660
[Feat11TotalFmla](#) 660
[Feat11WSSListInfo](#) 660
[Feat11XMap](#) 663
[Feat11XMapEntry](#) 663
[Feat11XMapEntry2](#) 664
[FeatFormulaErr2](#) 664
[FeatHdr](#) 292
[FeatHdr11](#) 293
[FeatProtection](#) 664
[FeatSmartTag](#) 665

[Feature11](#) 293
[Feature12](#) 295
[FFErrorCheck](#) 666
[Fields - vendor-extensible](#) 55
File storage
 [data spaces](#) 59
 [embedding](#) 59
 [link](#) 59
 [Office data store](#) 64
 [pivot cache](#) 65
 [VBA](#) 67
 [XML signatures](#) 75
File streams
 [component object](#) 58
 [control](#) 59
 [document summary information](#) 59
 [encryption](#) 59
 [list data](#) 60
 [Office toolbars](#) 64
 [OLE](#) 65
 [protected content](#) 65
 [revision](#) 65
 [signatures](#) 66
 [summary information](#) 66
 [user names](#) 67
 [viewer content](#) 67
 [workbook](#) 67
 [XML](#) 75
[File structure](#) 56
 [collection of records](#) 57
 [compound file](#) 56
 [future record](#) 57
 [record](#) 56
 [storages](#) 58
 [stream](#) 56
 [streams](#) 58
 [substream](#) 56
[FileLock](#) 295
[FilePass](#) 296
[FileSharing](#) 297
[FillPattern](#) 666
[FillStylePropertiesForShapePropsStreamChecksum](#)
 667
[FilterMode](#) 297
[Filters example](#) 946
[Filters: AutoFilter example](#) 947
[Filters: AutoFilterInfo example](#) 947
[Filters: FilterMode example](#) 946
[FnGroupName](#) 297
[FnGrp12](#) 297
[Font](#) 298
[FontIndex](#) 677
[FontInfo](#) 677
[FontScheme](#) 678
[FontX](#) 300
[Footer](#) 301
[ForceFullCalculation](#) 301
[Format](#) 302
[Format conflicts](#) 159
[FormatRun](#) 678
[Formatting example](#) 981
[Formatting: Font 1 example](#) 982
[Formatting: Font 2 example](#) 983
[Formatting: Format example](#) 984
[Formatting: Number 1 example](#) 993
[Formatting: Number 2 example](#) 994
[Formatting: Number 3 example](#) 995
[Formatting: XF 1 example](#) 985
[Formatting: XF 2 example](#) 987
[Formatting: XF 3 example](#) 989
[Formatting: XF 4 example](#) 991
[Formula](#) 309
[Formula elements](#) 82
[Formulas](#) 80
 [control tokens](#) 82
 [display tokens](#) 82
 [Formula elements](#) 82
 [Mem tokens](#) 82
 [operand tokens](#) 81
 [operator tokens](#) 81
[FormulaValue](#) 678
[Frame](#) 310
[FrftFlags](#) 679
[FrftFontList](#) 311
[FrftHeader](#) 680
[FrftHeaderOld](#) 680
[FrftRefHeader](#) 680
[FrftRefHeaderNoGrbit](#) 681
[FrftRefHeaderU](#) 681
[FrftWrapper](#) 311
[Ftab](#) 759
[FtCbIs](#) 682
[FtCbIsData](#) 682
[FtCf](#) 683
[FtCmo](#) 683
[FtEdoData](#) 686
[FtGboData](#) 687
[FtGmo](#) 687
[FtLbsData](#) 688
[FtMacro](#) 690
[FtNts](#) 691
[FtPictFmla](#) 691
[FtPioGrbit](#) 692
[FtRbo](#) 694
[FtSbs](#) 695
[FullColorExt](#) 696
[Future record](#) 57
 [chart](#) 58
 [PivotTable](#) 58
G
[GelFrame](#) 312
[Glossary](#) 28
[GradStop](#) 696
[GridSet](#) 314
[GUIDTypeLib](#) 314
[Guts](#) 314
H
[HCenter](#) 315
[Header](#) 315
[HeaderFooter](#) 319
[HFPicture](#) 320
[HiddenMemberSet](#) 697
[HideObj](#) 322
[HideObjEnum](#) 697
[HLink](#) 322
[HLinkTooltip](#) 322

[HorizAlign](#) 698
[HorizontalPageBreaks](#) 323
[HorzBrk](#) 698

I

[Icv](#) 698
[IcvChart](#) 702
[IcvFont](#) 702
[IcvXF](#) 702
[IFmt](#) 702
[IFmtRecord](#) 323
[Ilel](#) 786
[Implementer - security considerations](#) 1084
[Implementer - security considerations](#) 1084
[Index](#) 323
[Informative references](#) 52
[Insertion/deletion of rows/columns revision](#) 167
[InterfaceEnd](#) 324
[InterfaceHdr](#) 324
[InteriorColorPropertiesForShapePropsStreamChecksum](#)
[m](#) 703
[Intl](#) 324
[Introduction](#) 28
[ISSTInf](#) 704
[IXFCell](#) 704

K

[KPIProp](#) 704
[KPISets](#) 705

L

[Label](#) 325
[LabelSst](#) 325
[Lbl](#) 325
[LbsDropData](#) 705
[LeftMargin](#) 328
Legend ([section 2.2.3.8](#) 91, [section 2.4.152](#) 328)
[LegendException](#) 329
[Lel](#) 330
[LEMMode](#) 706
[Line](#) 330
[LineFormat](#) 331
[LinePropertiesForShapePropsStreamChecksum](#) 707
[Link storage](#) 59
[List data stream](#) 60
[List12](#) 332
[List12BlockLevel](#) 708
[List12DisplayName](#) 710
[List12TableStyleClientInfo](#) 711
[ListParsedArrayFormula](#) 787
[ListParsedFormula](#) 787
[Localization](#) 54
[LongRGB](#) 711
[LongRGBA](#) 712
[LPr](#) 333
[LPWideString](#) 712
[LRng](#) 334

M

[MarkerFormat](#) 334
[MDB](#) 336

[MDir](#) 712
[MDTInfo](#) 336
[MDTInfoIndex](#) 713
[MDX metadata](#) 105
[MDXKPI](#) 338
[MDXProp](#) 339
[MDXSet](#) 339
[MDXStr](#) 340
[MDXStrIndex](#) 713
[MDXTuple](#) 341
[Mem tokens](#) 82
[MergeCells](#) 341
[Metadata](#) 103
[cell metadata](#) 104
[MDX metadata](#) 105
[Metadata block](#) 105
[metadata types](#) 104
[value metadata](#) 104
[Metadata block](#) 105
[Metadata types](#) 104
[Mms](#) 342
[MOper](#) 713
[Move cells revision](#) 168
[MsoDrawing](#) 342
[MsoDrawingGroup](#) 342
[MsoDrawingSelection](#) 343
[MTRSettings](#) 343
[MulBlank](#) 344
[MulRk](#) 344

N

[NameCmt](#) 345
[NameFnGrp12](#) 346
[NameParsedFormula](#) 787
[NamePublish](#) 347
[NilChartNum](#) 714
[Normative references](#) 51
[Note](#) 347
[NoteRR](#) 714
[NoteSh](#) 715
[Number](#) 348

O

[Obj](#) 348
[ObjectLink](#) 351
[ObjectParsedFormula](#) 788
[ObjFmla](#) ([section 2.5.187](#) 716, [section 2.5.188](#) 717)
[ObjLinkFmla](#) 717
[ObjProtect](#) 351
[ObNoMacros](#) 352
[ObProj](#) 352
[ODBC connections](#) 163
[ODBCType](#) 718
[Office data store storage](#) 64
[Office toolbars stream](#) 64
[OfficeArtClientAnchorChart](#) 718
[OfficeArtClientAnchorHF](#) 719
[OfficeArtClientAnchorSheet](#) 720
[OfficeArtClientData](#) 721
[OfficeArtClientTextbox](#) 722
[OLE data item](#) 161
[OLE data source](#) 161
[OLE DB connections](#) 162

[OLE stream](#) 65
[OleDbConn](#) 352
[OleObjectSize](#) 353
[Operand tokens](#) 81
[Operator tokens](#) 81
[Organization of this documentation](#) 53
Overview
 [byte ordering](#) 53
 [organization of this documentation](#) 53
[Overview \(synopsis\)](#) 53

P

[Palette](#) 353
[Pane](#) 353
[PaneType](#) 722
[ParameterParsedFormula](#) 788
[ParamQry](#) 354
[PARAMQRY_Fixed](#) 723
Parsed expressions
 [ArrayParsedFormula](#) 724
 [BErr](#) 724
 [CellParsedFormula](#) 725
 [Cetab](#) 725
 [CFParsedFormula](#) 754
 [CFParsedFormulaNoCCE](#) 754
 [CFVOParsedFormula](#) 754
 [ChartParsedFormula](#) 755
 [DVParsedFormula](#) 755
 [ExtNameParsedFormula](#) 756
 [ExtPtgArea3D](#) 757
 [ExtPtgAreaErr3D](#) 757
 [ExtPtgErr](#) 757
 [ExtPtgRef3D](#) 758
 [ExtPtgRefErr3D](#) 758
 [ExtSheetPair structure](#) 758
 [Ftab](#) 759
 [Ilel](#) 786
 [ListParsedArrayFormula](#) 787
 [ListParsedFormula](#) 787
 [NameParsedFormula](#) 787
 [ObjectParsedFormula](#) 788
 [ParameterParsedFormula](#) 788
 [PivotParsedFormula](#) 789
 [Ptg](#) 789
 [PtgAdd](#) 792
 [PtgArea](#) 792
 [PtgArea3d](#) 793
 [PtgAreaErr](#) 793
 [PtgAreaErr3d](#) ([section 2.5.198.30](#) 794, [section 2.5.198.31](#) 794)
 [PtgArray](#) 795
 [PtgAttrBaxcel](#) 795
 [PtgAttrChoose](#) 796
 [PtgAttrGoto](#) 796
 [PtgAttrIf structure](#) 797
 [PtgAttrSemi](#) 797
 [PtgAttrSpace](#) 797
 [PtgAttrSpaceSemi](#) 798
 [PtgAttrSpaceType](#) 798
 [PtgAttrSum](#) 799
 [PtgBool](#) 799
 [PtgConcat](#) 799
 [PtgDataType](#) 799
 [PtgDiv](#) 800

[PtgElfCol](#) 800
[PtgElfColS](#) 800
[PtgElfColSV](#) 801
[PtgElfColV](#) 801
[PtgElfLel](#) 801
[PtgElfRadical](#) 802
[PtgElfRadicalLel](#) 802
[PtgElfRadicalS](#) 803
[PtgElfRw](#) 803
[PtgElfRwV](#) 804
[PtgEq](#) 804
[PtgErr](#) 804
[PtgExp](#) 804
[PtgExtraArray](#) 805
[PtgExtraElf](#) 805
[PtgExtraMem](#) 806
[PtgFunc](#) 806
[PtgFuncVar](#) 806
[PtgGe](#) 807
[PtgGt](#) 807
[PtgInt](#) 807
[PtgIsect](#) 808
[PtgLe](#) 808
[PtgLt](#) 808
[PtgMemArea](#) 808
[PtgMemErr](#) 809
[PtgMemFunc](#) 809
[PtgMemNoMem](#) 810
[PtgMissArg](#) 810
[PtgMul](#) 810
[PtgName](#) 811
[PtgNameX](#) 811
[PtgNe](#) 812
[PtgNum](#) 812
[PtgParen](#) 812
[PtgPercent](#) 813
[PtgPower](#) 813
[PtgRange](#) 813
[PtgRef](#) 813
[PtgRef3d](#) 814
[PtgRefErr](#) 814
[PtgRefErr3d](#) 815
[PtgRefN](#) 815
[PtgStr](#) 815
[PtgSub](#) 816
[PtgSxName](#) 816
[PtgTbl](#) 816
[PtgUminus](#) 817
[PtgUnion](#) 817
[PtgUplus](#) 817
[RevExtern](#) 818
[RevItab](#) 818
[RevLblName](#) 819
[RevName](#) 820
[RevNamePly](#) 821
[RevNameTabid](#) 821
[RevSheetName](#) 821
[RgbExtra](#) 822
[Rqce](#) 823
[RqceArea](#) 826
[RqceAreaRel](#) 827
[RqceElfLoc](#) 827
[RqceElfLocExtra](#) 828
[RqceLoc](#) 828
[RqceLoc8](#) 828

[RgceLocRel](#) 828
[SerAr](#) 829
[SerBool](#) 829
[SerErr](#) 830
[SerNil](#) 830
[SerNum](#) 830
[SerStr](#) 831
[SharedParsedFormula](#) 831
[XtiIndex](#) 832
[Password](#) 354
[password verifier algorithm](#) 163
[PBT](#) 832
[PhoneticInfo](#) 355
[PhRuns](#) 833
[Phs](#) 833
[PicF](#) 355
[PictFmlaEmbedInfo](#) 834
[PictFmlaKey](#) 834
[Pie](#) 356
[Pie Chart Sheet example](#) 973
[Pie chart sheet: AxesUsed example](#) 974
[Pie chart sheet: AxisParent example](#) 975
[Pie chart sheet: BRAI example](#) 980
[Pie chart sheet: Chart example](#) 973
[Pie chart sheet: ChartFormat example](#) 975
[Pie chart sheet: Legend example](#) 976
[Pie chart sheet: Pie example](#) 975
[Pie chart sheet: Pos example](#) 977
[Pie chart sheet: PrintSize example](#) 973
[Pie chart sheet: ShtProps example](#) 974
[Pie chart sheet: Text example](#) 978
[Pie chart sheet: Window2 example](#) 980
[PieFormat](#) 357
[Pivot cache storage](#) 65
[Pivot chart](#) 86
[PivotCache](#) 117
[PivotChartBits](#) 357
[PivotCompProp](#) 835
[PivotParsedFormula](#) 789
[PivotTable](#) 58
[PivotTable example](#) 1030
[PivotTable records](#) 107
[PivotTable view](#) 134
[PivotTable: DConRef example](#) 1032
[PivotTable: EOF example](#) 1083
[PivotTable: OsiSXTag example](#) 1065
[PivotTable: SXAddl 1 example](#) 1033
[PivotTable: SXAddl 2 example](#) 1034
[PivotTable: SXAddl 3 example](#) 1035
[PivotTable: SxAddl 4 example](#) 1067
[PivotTable: SxAddl 5 example](#) 1068
[PivotTable: SxAddl 6 example](#) 1070
[PivotTable: SXDB example](#) 1070
[PivotTable: SXDBB 1 example](#) 1081
[PivotTable: SXDBB 2 example](#) 1082
[PivotTable: SXDBEx example](#) 1072
[PivotTable: SXDI example](#) 1056
[PivotTable: SXDtr 1 example](#) 1076
[PivotTable: SXDtr 2 example](#) 1076
[PivotTable: SXEx example](#) 1063
[PivotTable: SXFDB 1 example](#) 1072
[PivotTable: SXFDB 2 example](#) 1075
[PivotTable: SXFDB 3 example](#) 1077
[PivotTable: SXFDB 4 example](#) 1078
[PivotTable: SXFDB 5 example](#) 1080
[PivotTable: SxIvd example](#) 1055
[PivotTable: SXLI 1 example](#) 1056
[PivotTable: SXLI 2 example](#) 1062
[PivotTable: SXNum 1 example](#) 1079
[PivotTable: SXNum 2 example](#) 1081
[PivotTable: SXNum 3 example](#) 1082
[PivotTable: SXPI example](#) 1055
[PivotTable: SXStreamID example](#) 1031
[PivotTable: SXString 1 example](#) 1074
[PivotTable: SXString 3 example](#) 1074
[PivotTable: SXString21 example](#) 1074
[PivotTable: Sxvd 1 example](#) 1039
[PivotTable: Sxvd 2 example](#) 1044
[PivotTable: Sxvd 3 example](#) 1048
[PivotTable: Sxvd 4 example](#) 1049
[PivotTable: Sxvd 5 example](#) 1052
[PivotTable: SXVDEx 1 example](#) 1043
[PivotTable: SXVDEx 2 example](#) 1047
[PivotTable: SXVDEx 3 example](#) 1051
[PivotTable: SXVDEx 4 example](#) 1053
[PivotTable: SXVI 1 example](#) 1040
[PivotTable: SXVI 2 example](#) 1041
[PivotTable: SXVI 3 example](#) 1041
[PivotTable: SXVI 4 example](#) 1042
[PivotTable: SXVI 5 example](#) 1046
[PivotTable: SXVI 6 example](#) 1046
[PivotTable: SXVI 7 example](#) 1047
[PivotTable: SxView example](#) 1035
[PivotTable: SXViewEx9 example](#) 1067
[PivotTable: SXVS example](#) 1031
[PivotTables](#) 106
[data functionality level](#) 117
[PivotCache](#) 117
[PivotTable records](#) 107
[PivotTable view](#) 134
[PlotArea](#) 358
[PlotGrowth](#) 358
[Pls](#) 358
[PLV](#) 359
[Pos](#) 359
[PositionMode](#) 835
[PrintGrid](#) 361
[PrintRowCol](#) 361
[PrintSize](#) 362
[Product behavior](#) 1085
[Prot4Rev](#) 362
[Prot4RevPass](#) 363
[Protect](#) 363
[Protected content stream](#) 65
[Ptg](#) 789
[PtgAdd](#) 792
[PtgArea](#) 792
[PtgArea3d](#) 793
[PtgAreaErr](#) 793
[PtgAreaErr3d \(section 2.5.198.30 794, section 2.5.198.31 794\)](#)
[PtgArray](#) 795
[PtgAttrBaxcel](#) 795
[PtgAttrChoose](#) 796
[PtgAttrGoto](#) 796
[PtgAttrIf](#) 797
[PtgAttrSemi](#) 797
[PtgAttrSpace](#) 797
[PtgAttrSpaceSemi](#) 798
[PtgAttrSpaceType](#) 798

[PtgAttrSum](#) 799
[PtgBool](#) 799
[PtgConcat](#) 799
[PtgDataType](#) 799
[PtgDiv](#) 800
[PtgElfCol](#) 800
[PtgElfColS](#) 800
[PtgElfColSV](#) 801
[PtgElfColV](#) 801
[PtgElfLeI](#) 801
[PtgElfRadical](#) 802
[PtgElfRadicalLeI](#) 802
[PtgElfRadicalS](#) 803
[PtgElfRw](#) 803
[PtgElfRwV](#) 804
[PtgEq](#) 804
[PtgErr](#) 804
[PtgExp](#) 804
[PtgExtraArray](#) 805
[PtgExtraElf](#) 805
[PtgExtraMem](#) 806
[PtgFunc](#) 806
[PtgFuncVar](#) 806
[PtgGe](#) 807
[PtgGt](#) 807
[PtgInt](#) 807
[PtgIsect](#) 808
[PtgLe](#) 808
[PtgLt](#) 808
[PtgMemArea](#) 808
[PtgMemErr](#) 809
[PtgMemFunc](#) 809
[PtgMemNoMem](#) 810
[PtgMissArg](#) 810
[PtgMul](#) 810
[PtgName](#) 811
[PtgNameX](#) 811
[PtgNe](#) 812
[PtgNum](#) 812
[PtgParen](#) 812
[PtgPercent](#) 813
[PtgPower](#) 813
[PtgRange](#) 813
[PtgRef](#) 813
[PtgRef3d](#) 814
[PtgRefErr](#) 814
[PtgRefErr3d](#) 815
[PtgRefN](#) 815
[PtgStr](#) 815
[PtgSub](#) 816
[PtgSxName](#) 816
[PtgTbl](#) 816
[PtgUminus](#) 817
[PtgUnion](#) 817
[PtgUplus](#) 817

Q

[Qsi](#) 363
[Qsif](#) 366
[Qsir](#) 367
[QsiSXTag](#) 369

R

[Radar](#) 371
[RadarArea](#) 371
[ReadingOrder](#) 835
[RealTimeData](#) 372
[RecalcId](#) 373
[RecipName](#) 373
[Record](#) 56
[Record enumeration](#) 168
 [by name](#) 169
 [by number](#) 180
Records
 [AIRuns](#) 191
 [Area](#) 191
 [AreaFormat](#) 192
 [Array](#) 197
 [AttachedLabel](#) 198
 [AutoFilter](#) 199
 [AutoFilter12](#) 201
 [AutoFilterInfo](#) 204
 [AxcExt](#) 204
 [AxesUsed](#) 207
 [Axis](#) 207
 [AxisLine](#) 208
 [AxisParent](#) 209
 [Backup](#) 209
 [Bar](#) 209
 [BCUsrs](#) 210
 [Begin](#) 210
 [BigName](#) 211
 [BkHim](#) 211
 [Blank](#) 212
 [BOF](#) 212
 [BookBool](#) 214
 [BookExt](#) 215
 [BoolErr](#) 216
 [BopPop](#) 216
 [BopPopCustom](#) 218
 [BottomMargin](#) 219
 [BoundSheet8](#) 220
 [BRAI](#) 221
 [BuiltInFnGroupCount](#) 222
 [CalcCount](#) 223
 [CalcDelta](#) 223
 [CalcIter](#) 223
 [CalcMode](#) 223
 [CalcPrecision](#) 224
 [CalcRefMode](#) 224
 [CalcSaveRecalc](#) 224
 [CatLab](#) 225
 [CatSerRange](#) 225
 [CbUsr](#) 227
 [CellWatch](#) 227
 [CF](#) 228
 [CF12](#) 229
 [CFEx](#) 232
 [Chart](#) 233
 [Chart3d](#) 234
 [Chart3DBarShape](#) 236
 [ChartFormat](#) 236
 [ChartFrtInfo](#) 237
 [ClrtClient](#) 238
 [CodeName](#) 239
 [CodePage](#) 239
 [ColInfo](#) 240
 [Compat12](#) 241

[CompressPictures](#) 241
[CondFmt](#) 242
[CondFmt12](#) 242
[Continue](#) 243
[Continue_SxaddlSxString](#) 431
[ContinueBigName](#) 243
[ContinueFrt](#) 244
[ContinueFrt11](#) 244
[ContinueFrt12](#) 245
[Country](#) 245
[CrErr](#) 247
[CRN](#) 247
[CrtLayout12](#) 248
[CrtLayout12A](#) 250
[CrtLine](#) 252
[CrtLink](#) 253
[CrtMIFrt](#) 253
[CrtMIFrtContinue](#) 254
[CUsr](#) 254
[Dat](#) 254
[DataFormat](#) 255
[DataLabExt](#) 255
[DataLabExtContents](#) 256
[Date1904](#) 257
[DBCCell](#) 257
[DbOrParamQry](#) 258
[DbQuery](#) 258
[DbQueryExt](#) 260
[DCon](#) 262
[DConBin](#) 264
[DConn](#) 265
[DConName](#) 270
[DConRef](#) 271
[DefaultRowHeight](#) 272
[DefaultText](#) 272
[DefColWidth](#) 273
[Dimensions](#) 273
[DocRoute](#) 274
[DropBar](#) 276
[DropDownObjIds](#) 277
[DSF](#) 277
[Dv](#) 277
[DVal](#) 280
[DXF](#) 281
[DxGCol](#) 282
[End](#) 282
[EndBlock](#) 282
[EndObject](#) 284
[EntExU2](#) 285
[EOF](#) 285
[Excel9File](#) 285
[ExternName](#) 285
[ExternSheet](#) 287
[ExtSST](#) 288
[ExtString](#) 288
[Fbi](#) 289
[Fbi2](#) 290
[Feat](#) 291
[FeatHdr](#) 292
[FeatHdr11](#) 293
[Feature11](#) 293
[Feature12](#) 295
[FileLock](#) 295
[FilePass](#) 296
[FileSharing](#) 297
[FilterMode](#) 297
[FnGroupName](#) 297
[FnGrp12](#) 297
[Font](#) 298
[FontX](#) 300
[Footer](#) 301
[ForceFullCalculation](#) 301
[Format](#) 302
[Formula](#) 309
[Frame](#) 310
[FrtFontList](#) 311
[FrtWrapper](#) 311
[GelFrame](#) 312
[GridSet](#) 314
[GUIDTypeLib](#) 314
[Guts](#) 314
[HCenter](#) 315
[Header](#) 315
[HeaderFooter](#) 319
[HFPicture](#) 320
[HideObj](#) 322
[HLink](#) 322
[HLinkTooltip](#) 322
[HorizontalPageBreaks](#) 323
[IFmtRecord](#) 323
[Index](#) 323
[InterfaceEnd](#) 324
[InterfaceHdr](#) 324
[Intl](#) 324
[Label](#) 325
[LabelSst](#) 325
[Lbl](#) 325
[LeftMargin](#) 328
[Legend](#) 328
[LegendException](#) 329
[LeI](#) 330
[Line](#) 330
[LineFormat](#) 331
[List12](#) 332
[LPr](#) 333
[LRng](#) 334
[MarkerFormat](#) 334
[MDB](#) 336
[MDTInfo](#) 336
[MDXKPI](#) 338
[MDXProp](#) 339
[MDXSet](#) 339
[MDXStr](#) 340
[MDXTuple](#) 341
[MergeCells](#) 341
[Mms](#) 342
[MsoDrawing](#) 342
[MsoDrawingGroup](#) 342
[MsoDrawingSelection](#) 343
[MTRSettings](#) 343
[MulBlank](#) 344
[MulRk](#) 344
[NameCmt](#) 345
[NameFnGrp12](#) 346
[NamePublish](#) 347
[Note](#) 347
[Number](#) 348
[Obj](#) 348
[ObjectLink](#) 351
[ObjProtect](#) 351

[ObNoMacros](#) 352
[ObProj](#) 352
[OleDbConn](#) 352
[OleObjectSize](#) 353
[Palette](#) 353
[Pane](#) 353
[ParamQry](#) 354
[Password](#) 354
[PhoneticInfo](#) 355
[PicF](#) 355
[Pie](#) 356
[PieFormat](#) 357
[PivotChartBits](#) 357
[PlotArea](#) 358
[PlotGrowth](#) 358
[Pls](#) 358
[PLV](#) 359
[Pos](#) 359
[PrintGrid](#) 361
[PrintRowCol](#) 361
[PrintSize](#) 362
[Prot4Rev](#) 362
[Prot4RevPass](#) 363
[Protect](#) 363
[Qsj](#) 363
[Qsif](#) 366
[Qsir](#) 367
[QsiSxTag](#) 369
[Radar](#) 371
[RadarArea](#) 371
[RealTimeData](#) 372
[RecalcId](#) 373
[RecipName](#) 373
[RefreshAll](#) 374
[RichTextStream](#) 374
[RightMargin](#) 376
[RK](#) 376
[Row](#) 377
[RRAutoFmt](#) 378
[RRDChgCell](#) 379
[RRDConflict](#) 383
[RRDDefName](#) 384
[RRDHead](#) 386
[RRDInfo](#) 388
[RRDInsDel](#) 389
[RRDInsDelBegin](#) 390
[RRDInsDelEnd](#) 390
[RRDMove](#) 390
[RRDMoveBegin](#) 391
[RRDMoveEnd](#) 391
[RRDRenSheet](#) 391
[RRDRstEtxp](#) 392
[RRDTQSIF](#) 393
[RRDUserView](#) 394
[RRFormat](#) 395
[RRInsertSh](#) 395
[RRSort](#) 396
[RRTabId](#) 397
[SBaseRef](#) 397
[Scatter](#) 398
[SCENARIO](#) 399
[ScenarioProtect](#) 400
[ScenMan](#) 400
[Scl](#) 401
[Selection](#) 401
[SerAuxErrBar](#) 402
[SerAuxTrend](#) 403
[SerFmt](#) 404
[Series](#) 405
[SeriesList](#) 406
[SeriesText](#) 406
[SerParent](#) 406
[SerToCrt](#) 407
[Setup](#) 407
[ShapePropsStream](#) 412
[SheetExt](#) 413
[ShrFmla](#) 414
[ShtProps](#) 414
[SIIndex](#) 415
[Sort](#) 416
[SortData](#) 417
[SST](#) 419
[StartBlock](#) 420
[StartObject](#) 425
[String](#) 426
[Style](#) 426
[StyleExt](#) 427
[SupBook](#) 428
[Surf](#) 430
[SXAddl](#) 431
[SXAddl SXCAutoSort SXDEnd](#) 432
[SXAddl SXCAutoSort SXDId](#) 432
[SXAddl SXCCache SXDEnd](#) 433
[SXAddl SXCCache SXDId](#) 433
[SXAddl SXCCache SXDInfo12](#) 433
[SXAddl SXCCache SXDInvRefreshReal](#) 434
[SXAddl SXCCache SXDVer10Info](#) 434
[SXAddl SXCCache SXDVerSxMacro](#) 435
[SXAddl SXCCache SXDVerUpdInv](#) 436
[SXAddl SXCCacheField SXDCaption](#) 436
[SXAddl SXCCacheField SXDEnd](#) 436
[SXAddl SXCCacheField SXDId](#) 437
[SXAddl SXCCacheField SXDIfdbMempropMap](#) 437
[SXAddl SXCCacheField SXDIfdbMpMapCount](#) 438
[SXAddl SXCCacheField SXDProperty](#) 438
[SXAddl SXCCacheField SXDPropName](#) 439
[SXAddl SXCCacheField SXDSxmitmCount](#) 439
[SXAddl SXCCacheItem SXDEnd](#) 440
[SXAddl SXCCacheItem SXDId](#) 440
[SXAddl SXCCacheItem SXDitmMpMapCount](#) 440
[SXAddl SXCCacheItem SXDitmMpropMap](#) 441
[SXAddl SXCCacheItem SXDSxmitmDisp](#) 441
[SXAddl SXCField SXDEnd](#) 442
[SXAddl SXCField SXDId](#) 442
[SXAddl SXCField SXDVer10Info](#) 442
[SXAddl SXCField12 SXDAutoshow](#) 443
[SXAddl SXCField12 SXDEnd](#) 443
[SXAddl SXCField12 SXDId](#) 444
[SXAddl SXCField12 SXDISXTH](#) 444
[SXAddl SXCField12 SXDMemberCaption](#) 445
[SXAddl SXCField12 SXDVer12Info](#) 445
[SXAddl SXCField12 SXDVerUpdInv](#) 446
[SXAddl SXCGroup SXDEnd](#) 446
[SXAddl SXCGroup SXDGrpInfo](#) 447
[SXAddl SXCGroup SXDId](#) 448
[SXAddl SXCGroup SXDMember](#) 448
[SXAddl SXCGrpLevel SXDEnd](#) 449
[SXAddl SXCGrpLevel SXDGrpLevelInfo](#) 449
[SXAddl SXCGrpLevel SXDId](#) 450
[SXAddl SXCHierarchy SXDDisplayFolder](#) 450

[SXAddl SXCHierarchy SXDEnd](#) 451
[SXAddl SXCHierarchy SXDFilterMember](#) 451
[SXAddl SXCHierarchy SXDFilterMember12](#) 452
[SXAddl SXCHierarchy SXDIIconSet](#) 453
[SXAddl SXCHierarchy SXDIId](#) 453
[SXAddl SXCHierarchy SXDInfo12](#) 454
[SXAddl SXCHierarchy SXDKPIGoal](#) 455
[SXAddl SXCHierarchy SXDKPIStatus](#) 455
[SXAddl SXCHierarchy SXDKPITime](#) 455
[SXAddl SXCHierarchy SXDKPITrend](#) 456
[SXAddl SXCHierarchy SXDKPIValue](#) 456
[SXAddl SXCHierarchy SXDKPIWeight](#) 457
[SXAddl SXCHierarchy SXDMeasureGrp](#) 457
[SXAddl SXCHierarchy SXDParentKPI](#) 458
[SXAddl SXCHierarchy SXDProperty](#) 458
[SXAddl SXCHierarchy SXDSXSetParentUnique](#) 460
[SXAddl SXCHierarchy SXDUserCaption](#) 460
[SXAddl SXCHierarchy SXDVerUpdInv](#) 460
[SXAddl SXCQsi SXDEnd](#) 461
[SXAddl SXCQsi SXDIId](#) 461
[SXAddl SXCQuery SXDEnd](#) 461
[SXAddl SXCQuery SXDRReconnCond](#) 462
[SXAddl SXCQuery SXDSrcConnFile](#) 463
[SXAddl SXCQuery SXDSrcDataFile](#) 463
[SXAddl SXCQuery SXDXMLSource](#) 463
[SXAddl SXCSXCondFmt SXDEnd](#) 464
[SXAddl SXCSXCondFmt SXDSXCondFmt](#) 464
[SXAddl SXCSXCondFmts SXDEnd](#) 465
[SXAddl SXCSXCondFmts SXDIId](#) 466
[SXAddl SXCSXDH SXDEnd](#) 466
[SXAddl SXCSXDH SXDIId](#) 467
[SXAddl SXCSXDH SXDSxdh](#) 467
[SXAddl SXCSXfilt SXDEnd](#) 468
[SXAddl SXCSXfilt SXDIId](#) 469
[SXAddl SXCSXfilt SXDSXfilt](#) 469
[SXAddl SXCSXfilt SXDSXitm](#) 470
[SXAddl SXCSXFilter12 SXDCaption](#) 471
[SXAddl SXCSXFilter12 SXDEnd](#) 472
[SXAddl SXCSXFilter12 SXDIId](#) 472
[SXAddl SXCSXFilter12 SXDSXFilter](#) 472
[SXAddl SXCSXFilter12 SXDSXFilterDesc](#) 474
[SXAddl SXCSXFilter12 SXDSXFilterValue1](#) 474
[SXAddl SXCSXFilter12 SXDSXFilterValue2](#) 474
[SXAddl SXCSXFilter12 SXDXIsFilter](#) 475
[SXAddl SXCSXFilter12 SXDXIsFilterValue1](#) 475
[SXAddl SXCSXFilter12 SXDXIsFilterValue2](#) 476
[SXAddl SXCSXFilters12 SXDEnd](#) 476
[SXAddl SXCSXFilters12 SXDIId](#) 477
[SXAddl SXCSXMq SXDEnd](#) 477
[SXAddl SXCSXMq SXDIId](#) 477
[SXAddl SXCSXMq SXDUserCaption](#) 478
[SXAddl SXCSXMqs SXDEnd](#) 478
[SXAddl SXCSXMqs SXDIId](#) 478
[SXAddl SXCSXMqs SXDMGrpSXDHMap](#) 479
[SXAddl SXCSXrule SXDEnd](#) 480
[SXAddl SXCSXrule SXDIId](#) 480
[SXAddl SXCSXrule SXDSXrule](#) 480
[SXAddl SXCView SXDCalcMember](#) 483
[SXAddl SXCView SXDCalcMemString](#) 485
[SXAddl SXCView SXDCompactColHdr](#) 485
[SXAddl SXCView SXDCompactRwHdr](#) 486
[SXAddl SXCView SXDEnd](#) 486
[SXAddl SXCView SXDIId](#) 487
[SXAddl SXCView SXDSXPIIvmb](#) 487
[SXAddl SXCView SXDTableStyleClient](#) 488
[SXAddl SXCView SXDVer10Info](#) 488
[SXAddl SXCView SXDVer12Info](#) 490
[SXAddl SXCView SXDVerUpdInv](#) 492
[SxBool](#) 493
[SXDB](#) 493
[SXDBB](#) 494
[SXDBEx](#) 494
[SXDI](#) 495
[SXDtr](#) 497
[SxDXF](#) 497
[SxErr](#) 498
[SxEx](#) 498
[SXFDB](#) 501
[SXFDBType](#) 504
[SxFilt](#) 504
[SxFmla](#) 505
[SxFormat](#) 506
[SxFormula](#) 506
[SxInt](#) 506
[SxIsxoper](#) 507
[SxItm](#) 507
[SxIvd](#) 508
[SxLI](#) 509
[SxName](#) 509
[SxNil](#) 510
[SXNum](#) 510
[SXPair](#) 510
[SXPI](#) 511
[SXPIEx](#) 512
[SXRng](#) 512
[SxRule](#) 514
[SxSelect](#) 516
[SXStreamID](#) 518
[SXString](#) 518
[SXTbl](#) 518
[SxTbpg](#) 519
[SXTBRGIITM](#) 520
[SxTH](#) 520
[Sxvd](#) 523
[SXVDEx](#) 527
[SXVDTEx](#) 530
[SXVI](#) 531
[SxView](#) 533
[SxViewEx](#) 535
[SxViewEx9](#) 536
[SxViewLink](#) 537
[SXVS](#) 538
[Sync](#) 538
[Table](#) 538
[TableStyle](#) 540
[TableStyleElement](#) 541
[TableStyles](#) 544
[Template](#) 545
[Text](#) 545
[TextPropsStream](#) 550
[Theme](#) 552
[Tick](#) 552
[TopMargin](#) 555
[TxO](#) 556
[TxtQry](#) 558
[Uncalced](#) 560
[Units](#) 560
[UserBView](#) 560
[UserSViewBegin](#) 564
[UserSViewBegin Chart](#) 567

[UserSViewEnd](#) 569
[UsesELFs](#) 569
[UsrChk](#) 569
[UsrExcl](#) 570
[UsrInfo](#) 571
[ValueRange](#) 571
[VCenter](#) 574
[VerticalPageBreaks](#) 574
[WebPub](#) 574
[Window1](#) 577
[Window2](#) 578
[WinProtect](#) 580
[WOpt](#) 581
[WriteAccess](#) 582
[WriteProtect](#) 583
[WsBool](#) 583
[XCT](#) 584
[XF](#) 584
[XFCRC](#) 585
[XExt](#) 585
[YMult](#) 586
[Ref](#) 836
[Ref8](#) 836
[Ref8U](#) 837
[Ref8U2007](#) 837
[References](#) 51
 [informative](#) 52
 [normative](#) 51
[RefreshAll](#) 374
[RefU](#) 838
[Relationship to protocols and other structures](#) 54
[RevExtern](#) 818
[Revision logs](#) 167
[Revision records](#) 167
[Revision stream](#) 65
[RevisionType](#) 838
[RevItab](#) 818
[RevLblName](#) 819
[RevName](#) 820
[RevNamePly](#) 821
[RevNameTabid](#) 821
[RevSheetName](#) 821
[RFX](#) 839
[RgbExtra](#) 822
[Rgce](#) 823
[RgceArea](#) 826
[RgceAreaRel](#) 827
[RgceElfLoc](#) 827
[RgceElfLocExtra](#) 828
[RgceLoc](#) 828
[RgceLoc8](#) 828
[RgceLocRel](#) 828
[RichTextStream](#) 374
[RichTextStreamChecksumData](#) 839
[RichTextStreamChecksumFontInformation](#) 841
[RichTextStreamChecksumFontInformationArrayItem](#)
 843
[RightMargin](#) 376
[RK](#) 376
[RkNumber](#) 843
[RkRec](#) 844
[Row](#) 377
[RPHSSub](#) 844
[RRAutoFmt](#) 378
[RRD](#) 845
[RRDChgCell](#) 379
[RRDConflict](#) 383
[RRDDefName](#) 384
[RRDDefNameFlags](#) 845
[RRDHead](#) 386
[RRDInfo](#) 388
[RRDInsDel](#) 389
[RRDInsDelBegin](#) 390
[RRDInsDelEnd](#) 390
[RRDMove](#) 390
[RRDMoveBegin](#) 391
[RRDMoveEnd](#) 391
[RRDRenSheet](#) 391
[RRDRstEtxp](#) 392
[RRDTQSIF](#) 393
[RRDUserView](#) 394
[RRFormat](#) 395
[RRInsertSh](#) 395
[RRLoc](#) 847
[RRSort](#) 396
[RRTabId](#) 397
[RTDEItem](#) 847
[RTDOper](#) 847
[RTDOperStr](#) 848
[Run](#) 848
[Rw](#) 848
[Rw12](#) 849
[RwLongU](#) 849
[RwU](#) 849
[Rwx](#) 849

S

[SBaseRef](#) 397
[Scatter](#) 398
[SCENARIO](#) 399
[ScenarioProtect](#) 400
[ScenMan](#) 400
[Scl](#) 401
[Script](#) 850
[SD_SetSortOrder](#) 850
[SDContainer](#) 850
[Security - implementer considerations](#) 1084
[Security - implementer considerations](#) 1084
 Security considerations
 [encryption \(password to open\)](#) 164
 [password verifier algorithm](#) 163
[SecurityDescriptor](#) 851
[Selection](#) 401
[SerAr](#) 829
[SerAuxErrBar](#) 402
[SerAuxTrend](#) 403
[SerBool](#) 829
[SerErr](#) 830
[SerFmt](#) 404
 Series ([section 2.2.3.9](#) 93, [section 2.4.252](#) 405)
[SeriesList](#) 406
[SeriesText](#) 406
[SerNil](#) 830
[SerNum](#) 830
[SerParent](#) 406
[SerStr](#) 831
[SerToCrt](#) 407
[Setup](#) 407
[ShapePropsStream](#) 412

[ShapePropsStreamChecksumData](#) 851
[Shared feature](#) 168
[Shared workbooks](#) 165
 [change cells revision](#) 168
 [insertion/deletion of rows/columns revision](#) 167
 [move cells revision](#) 168
 [revision logs](#) 167
 [revision records](#) 167
 [sort map](#) 168
 [user log](#) 167
[SharedFeatureType](#) 852
[SharedParsedFormula](#) 831
[SheetExt](#) 413
[SheetExtOptional](#) 853
[ShortDTR](#) 854
[ShortXLUnicodeString](#) 854
[ShrFmla](#) 414
[ShtProps](#) 414
[Signatures stream](#) 66
[SIIndex](#) 415
[SLCO8](#) 855
[Sort](#) 416
 [sort map](#) 168
 [SortCond12](#) 855
 [SortData](#) 417
 [SortItem](#) 856
 [SourceType](#) 857
[SPRC](#) 103
[SQElfFlags](#) 857
[SqRef](#) 857
[SqRefU](#) 858
[SST](#) 419
[StartBlock](#) 420
[StartObject](#) 425
[Storages](#) 58
[Stream](#) 56
[Streams](#) 58
 [document summary information](#) 59
[String](#) 426
Structures
 [AddinUdf](#) 587
 [AF12CellIcon](#) 587
 [AF12Criteria](#) 588
 [AF12DateInfo](#) 588
 [AFDOper](#) 589
 [AFDOperBoolErr](#) 590
 [AFDOperRk](#) 591
 [AFDOperStr](#) 591
 [ArrayParsedFormula](#) 724
 [AutoFmt8](#) 592
 [BErr](#) 724
 [Bes](#) 593
 [Bold](#) 594
 [BookExt_Conditional11](#) 594
 [BookExt_Conditional12](#) 594
 [Boolean](#) 595
 [BorderStyle](#) 595
 [BuiltInStyle](#) 596
 [CachedDiskHeader](#) 596
 [Cch255](#) 597
 [Cell](#) 597
 [CellParsedFormula](#) 725
 [CellXF](#) 597
 [Cetab](#) 725
 [CFColor](#) 601
 [CFDatabar](#) 601
 [CFExAveragesTemplateParams](#) 603
 [CFExDateTemplateParams](#) 603
 [CFExDefaultTemplateParams](#) 604
 [CFExFilterParams](#) 604
 [CFExNonCF12](#) 605
 [CFExTemplateParams](#) 607
 [CFExTextTemplateParams](#) 608
 [CFFilter](#) 608
 [CFFlag](#) 609
 [CFGradient](#) 610
 [CFGradientInterpItem](#) 610
 [CFGradientItem](#) 611
 [CFMStateItem](#) 612
 [CFMultistate](#) 612
 [CFParsedFormula](#) 754
 [CFParsedFormulaNoCCE](#) 754
 [CFrtId](#) 613
 [CFT](#) 614
 [CFVO](#) 615
 [CFVOParsedFormula](#) 754
 [ChartNumNillable](#) 616
 [ChartParsedFormula](#) 755
 [Col](#) 616
 [Col_NegativeOne](#) 616
 [Col12](#) 617
 [Col256U](#) 617
 [ColByte](#) 617
 [ColByteU](#) 618
 [ColElfU](#) 618
 [ColorICV](#) 618
 [ColorTheme](#) 619
 [ColRelNegU](#) 619
 [ColRelU](#) 620
 [ColSico8U](#) 620
 [ColU](#) 620
 [Colx](#) 621
 [conceptual overview](#) 79
 [CondDataValue](#) 621
 [CondFmtStructure](#) 621
 [ConnGrbitDbt](#) 622
 [ConnGrbitDbtAdo](#) 622
 [ConnGrbitDbtOledb](#) 623
 [ConnGrbitDbtWeb](#) 624
 [ControlInfo](#) 625
 [CrtLayout12Mode](#) 625
 [DataFunctionalityLevel](#) 626
 [DataSourceType](#) 626
 [DateAsNum](#) 626
 [DateUnit](#) 626
 [DCol](#) 627
 [DColByteU](#) 627
 [DConFile](#) 627
 [DConnConnectionOleDb](#) 628
 [DConnConnectionWeb](#) 629
 [DConnId](#) 629
 [DConnParamBinding](#) 630
 [DConnParamBindingValByte](#) 630
 [DConnParamBindingValInt](#) 630
 [DConnParamBindingValString](#) 630
 [DConnParamBindingValType](#) 631
 [DConnParameter](#) 631
 [DConnStringSequence](#) 632
 [DConnUnicodeStringSegmented](#) 632
 [DJoin](#) 633

[DRw](#) 633
[DRwByteU](#) 633
[Duce](#) 633
[DuceRadical](#) 634
[DuceStacked](#) 635
[Ducr](#) 635
[DucrConditionalLbl](#) 636
[DucrConditionalNoLbl](#) 637
[DVParsedFormula](#) 755
[DwQsiFuture](#) 637
[DXFALC](#) 638
[DXFBdr](#) 639
[DXFFntD](#) 640
[DXFId](#) 641
[DXFN](#) 641
[DXFN12](#) 644
[DXFN12List](#) 645
[DXFN12NoCB](#) 645
[DXFNum](#) 645
[DXFNumIFmt](#) 646
[DXFNumUsr](#) 646
[DXFPat](#) 646
[DXFProt](#) 647
[EnhancedProtection](#) 647
[ExternDdeLinkNoOper](#) 648
[ExternDocName](#) 648
[ExternOleDdeLink](#) 649
[ExtNameParsedFormula](#) 756
[ExtProp](#) 649
[ExtPtgArea3D](#) 757
[ExtPtgAreaErr3D](#) 757
[ExtPtgErr](#) 757
[ExtPtgRef3D](#) 758
[ExtPtgRefErr3D](#) 758
[ExtRst](#) 650
[ExtSheetPair](#) 758
[FactoidData](#) 651
[Feat11CellStruct](#) 651
[Feat11FdaAutoFilter](#) 651
[Feat11FieldDataItem](#) 652
[Feat11Fmla](#) 659
[Feat11RgInvalidCells](#) 659
[Feat11RgSharepointIdChange](#) 659
[Feat11RgSharepointIdDel](#) 660
[Feat11TotalFmla](#) 660
[Feat11WSSListInfo](#) 660
[Feat11XMap](#) 663
[Feat11XMapEntry](#) 663
[Feat11XMapEntry2](#) 664
[FeatFormulaErr2](#) 664
[FeatProtection](#) 664
[FeatSmartTag](#) 665
[FFErrorCheck](#) 666
[file structure](#) 56
[FillPattern](#) 666
[FillStylePropertiesForShapePropsStreamChecksum](#) 667
[FontIndex](#) 677
[FontInfo](#) 677
[FontScheme](#) 678
[FormatRun](#) 678
[FormulaValue](#) 678
[FrtFlags](#) 679
[FrtHeader](#) 680
[FrtHeaderOld](#) 680
[FrtRefHeader](#) 680
[FrtRefHeaderNoGrbit](#) 681
[FrtRefHeaderU](#) 681
[Ftab](#) 759
[FtCbIs](#) 682
[FtCbIsData](#) 682
[FtCf](#) 683
[FtCmo](#) 683
[FtEdoData](#) 686
[FtGboData](#) 687
[FtGmo](#) 687
[FtLbsData](#) 688
[FtMacro](#) 690
[FtNts](#) 691
[FtPictFmla](#) 691
[FtPioGrbit](#) 692
[FtRbo](#) 694
[FtRboData](#) 694
[FtSbs](#) 695
[FullColorExt](#) 696
[GradStop](#) 696
[HiddenMemberSet](#) 697
[HideObjEnum](#) 697
[HorizAlign](#) 698
[HorzBrk](#) 698
[Icv](#) 698
[IcvChart](#) 702
[IcvFont](#) 702
[IcvXF](#) 702
[IFmt](#) 702
[Ilel](#) 786

[InteriorColorPropertiesForShapePropsStreamChecksum](#) 703
[ISSTInf](#) 704
[IXFCell](#) 704
[KPIProp](#) 704
[KPISets](#) 705
[LbsDropData](#) 705
[LEMMode](#) 706
[LinePropertiesForShapePropsStreamChecksum](#) 707
[List12BlockLevel](#) 708
[List12DisplayName](#) 710
[List12TableStyleClientInfo](#) 711
[ListParsedArrayFormula](#) 787
[ListParsedFormula](#) 787
[LongRGB](#) 711
[LongRGBA](#) 712
[LPWideString](#) 712
[MDir](#) 712
[MDTInfoIndex](#) 713
[MDXStrIndex](#) 713
[MOper](#) 713
[NameParsedFormula](#) 787
[NilChartNum](#) 714
[NoteRR](#) 714
[NoteSh](#) 715
[ObjectParsedFormula](#) 788
[ObjFmla \(section 2.5.187 716, section 2.5.188 717\)](#)
[ObjLinkFmla](#) 717
[ODBCType](#) 718
[OfficeArtClientAnchorChart](#) 718
[OfficeArtClientAnchorHF](#) 719
[OfficeArtClientAnchorSheet](#) 720

[OfficeArtClientData](#) 721
[OfficeArtClientTextbox](#) 722
[PaneType](#) 722
[ParameterParsedFormula](#) 788
[PARAMORY Fixed](#) 723
[PBT](#) 832
[PhRuns](#) 833
[Phs](#) 833
[PictFmlaEmbedInfo](#) 834
[PictFmlaKey](#) 834
[PivotCompProp](#) 835
[PivotParsedFormula](#) 789
[PositionMode](#) 835
[Ptg](#) 789
[PtgAdd](#) 792
[PtgArea](#) 792
[PtgArea3d](#) 793
[PtgAreaErr](#) 793
[PtgAreaErr3d](#) 794
[PtgAreaN](#) 794
[PtgArray](#) 795
[PtgAttrBaxcel](#) 795
[PtgAttrChoose](#) 796
[PtgAttrGoto](#) 796
[PtgAttrIf](#) 797
[PtgAttrSemi](#) 797
[PtgAttrSpace](#) 797
[PtgAttrSpaceSemi](#) 798
[PtgAttrSpaceType](#) 798
[PtgAttrSum](#) 799
[PtgBool](#) 799
[PtgConcat](#) 799
[PtgDataType](#) 799
[PtgDiv](#) 800
[PtgElfCol](#) 800
[PtgElfColS](#) 800
[PtgElfColSV](#) 801
[PtgElfColV](#) 801
[PtgElfLel](#) 801
[PtgElfRadical](#) 802
[PtgElfRadicalLel](#) 802
[PtgElfRadicalS](#) 803
[PtgElfRw](#) 803
[PtgElfRwV](#) 804
[PtgEq](#) 804
[PtgErr](#) 804
[PtgExp](#) 804
[PtgExtraArray](#) 805
[PtgExtraElf](#) 805
[PtgExtraMem](#) 806
[PtgFunc](#) 806
[PtgFuncVar](#) 806
[PtgGe](#) 807
[PtgGt](#) 807
[PtgInt](#) 807
[PtgIsect](#) 808
[PtgLe](#) 808
[PtgLt](#) 808
[PtgMemArea](#) 808
[PtgMemErr](#) 809
[PtgMemFunc](#) 809
[PtgMemNoMem](#) 810
[PtgMissArg](#) 810
[PtgMul](#) 810
[PtgName](#) 811

[PtgNameX](#) 811
[PtgNe](#) 812
[PtgNum](#) 812
[PtgParen](#) 812
[PtgPercent](#) 813
[PtgPower](#) 813
[PtgRange](#) 813
[PtgRef](#) 813
[PtgRef3d](#) 814
[PtgRefErr](#) 814
[PtgRefErr3d](#) 815
[PtgRefN](#) 815
[PtgStr](#) 815
[PtgSub](#) 816
[PtgSxName](#) 816
[PtgTbl](#) 816
[PtgUminus](#) 817
[PtgUnion](#) 817
[PtgUplus](#) 817
[ReadingOrder](#) 835
[record enumeration](#) 168
[Ref](#) 836
[Ref8](#) 836
[Ref8U](#) 837
[Ref8U2007](#) 837
[RefU](#) 838
[RevExtern](#) 818
[RevisionType](#) 838
[RevItab](#) 818
[RevLblName](#) 819
[RevName](#) 820
[RevNamePly](#) 821
[RevNameTabid](#) 821
[RevSheetName](#) 821
[RFX](#) 839
[RqbExtra](#) 822
[Rqce](#) 823
[RqceArea](#) 826
[RqceAreaRel](#) 827
[RqceElfLoc](#) 827
[RqceElfLocExtra](#) 828
[RqceLoc](#) 828
[RqceLoc8](#) 828
[RqceLocRel](#) 828
[RichTextStreamChecksumData](#) 839
[RichTextStreamChecksumFontInformation](#) 841

[RichTextStreamChecksumFontInformationArrayItem](#) 843
[RkNumber](#) 843
[RkRec](#) 844
[RPHSSub](#) 844
[RRD](#) 845
[RRDDefNameFlags](#) 845
[RRLoc](#) 847
[RTDEItem](#) 847
[RTDOper](#) 847
[RTDOperStr](#) 848
[Run](#) 848
[Rw](#) 848
[Rw12](#) 849
[RwLongU](#) 849
[RwU](#) 849
[Rwx](#) 849
[Script](#) 850

[SD_SetSortOrder](#) 850
[SDContainer](#) 850
[SecurityDescriptor](#) 851
[SerAr](#) 829
[SerBool](#) 829
[SerErr](#) 830
[SerNil](#) 830
[SerNum](#) 830
[SerStr](#) 831
[ShapePropsStreamChecksumData](#) 851
[SharedFeatureType](#) 852
[SharedParsedFormula](#) 831
[SheetExtOptional](#) 853
[ShortDTR](#) 854
[ShortXLUnicodeString](#) 854
[SLCO8](#) 855
[SortCond12](#) 855
[SortItem](#) 856
[SourceType](#) 857
[SQEffFlags](#) 857
[SqRef](#) 857
[SqRefU](#) 858
[Stxp](#) 858
[StyleXF](#) 859
[SxAddl_SXDEnd](#) 861
[SxAddl_SXDVerUpdInv](#) 861
[SxAddl_SXString](#) 861
[SXAddlHdr](#) 862
[SXAxis](#) 862
[SXEZDoper](#) 862
[SxFT](#) 863
[SxIvdCol](#) 867
[SxIvdRw](#) 867
[SXLItem](#) 867
[SXPI_Item](#) 870
[SXVDEx_Opt](#) 870
[SxView9Save](#) 871
[SXVIFlags](#) 871
[TabId](#) 872
[TabIndex](#) 872
[TableFeatureType](#) 872
[Tag_Fn_MDX](#) 876
[TextPropsStreamChecksumData](#) 877
[Top10FT](#) 879
[Ts](#) 879
[TxOLastRun](#) 879
[TxORuns](#) 880
[TxtWf](#) 880
[Underline](#) 881
[VertAlign](#) 881
[VertBrk](#) 881
[VirtualPath](#) 881
[WebPubString](#) 883
[XColorType](#) 884
[XExtGradient](#) 884
[XExtNoFRT](#) 885
[XFIndex](#) 885
[XFProp](#) 887
[XFPropBorder](#) 889
[XFPropColor](#) 889
[XFPropGradient](#) 890
[XFPropGradientStop](#) 891
[XFProps](#) 891
[XFPropTextRotation](#) 892
[XLNameUnicodeString](#) 892
[XlsFilter_Criteria](#) 893
[XlsFilter_Top10](#) 894
[XLUnicodeRichExtendedString](#) 895
[XLUnicodeString](#) 896
[XLUnicodeStringMin2](#) 897
[XLUnicodeStringNoCch](#) 897
[XLUnicodeStringSegmented](#) 897
[XLUnicodeStringSegmentedRTD](#) 898
[XLUnicodeStringSegmentedSXAddl](#) 898
[XmITkBackWallThicknessFrnt](#) 899
[XmITkBaseTimeUnitFrnt](#) 899
[XmITkBlob](#) 900
[XmITkBool](#) 900
[XmITkChain](#) 901
[XmITkColorMappingOverride](#) 903
[XmITkDispBlanksAsFrnt](#) 903
[XmITkDouble](#) 904
[XmITkDWord](#) 904
[XmITkEnd](#) 905
[XmITkEndSurface](#) 905
[XmITkFloorThicknessFrnt](#) 905
[XmITkFormatCodeFrnt](#) 906
[XmITkHeader](#) 906
[XmITkHeightPercent](#) 906
[XmITkLogBaseFrnt](#) 907
[XmITkMajorUnitFrnt](#) 907
[XmITkMajorUnitTypeFrnt](#) 907
[XmITkMaxFrnt](#) 908
[XmITkMinFrnt](#) 908
[XmITkMinorUnitFrnt](#) 909
[XmITkMinorUnitTypeFrnt](#) 909
[XmITkNoMultiLvlLbl](#) 910
[XmITkOverlay](#) 910
[XmITkPerspectiveFrnt](#) 911
[XmITkPieComboFrom12Frnt](#) 911
[XmITkRangAxOffFrnt](#) 911
[XmITkRotXFrt](#) 912
[XmITkRotYFrt](#) 912
[XmITkShowDLblsOverMax](#) 912
[XmITkSpb](#) 913
[XmITkStart](#) 913
[XmITkStartSurface](#) 913
[XmITkString](#) 914
[XmITkStyle](#) 914
[XmITkSymbolFrnt](#) 914
[XmITkThemeOverride](#) 915
[XmITkTickLabelPositionFrnt](#) 915
[XmITkTickLabelSkipFrnt](#) 916
[XmITkTickMarkSkipFrnt](#) 916
[XmITkToken](#) 916
[XmITkTpb](#) 917
[Xnum](#) 917
[XORObfuscation](#) 917
[XTI](#) 917
[XtiIndex](#) 832
[Stxp](#) 858
[Style](#) 426
[StyleExt](#) 427
[Styles](#) 157
[differential formatting \(DXFs\)](#) 158
[format conflicts](#) 159
[table styles](#) 159
[XFs](#) 157
[StyleXF](#) 859
[Substream](#) 56

[Summary information stream](#) 66
[SupBook](#) 428
[Supporting link](#) 160
[Surf](#) 430
[SXAddl](#) 431
[SxAddl records \(section 2.4.273.29](#) 443, [section 2.4.273.86](#) 475)
[Continue SxaddlSxString](#) 431
[SXAddl](#) 431
[SXAddl SXCAutoSort SXDEnd](#) 432
[SXAddl SXCAutoSort SXDIId](#) 432
[SXAddl SXCCache SXDEnd](#) 433
[SXAddl SXCCache SXDIId](#) 433
[SXAddl SXCCache SXDInfo12](#) 433
[SXAddl SXCCache SXDIInvRefreshReal](#) 434
[SXAddl SXCCache SXDVer10Info](#) 434
[SXAddl SXCCache SXDVerSxMacro](#) 435
[SXAddl SXCCache SXDVerUpdInv](#) 436
[SXAddl SXCCacheField SXDCaption](#) 436
[SXAddl SXCCacheField SXDEnd](#) 436
[SXAddl SXCCacheField SXDIId](#) 437
[SXAddl SXCCacheField SXDIfdbMempropMap](#) 437
[SXAddl SXCCacheField SXDIfdbMpMapCount](#) 438
[SXAddl SXCCacheField SXDProperty](#) 438
[SXAddl SXCCacheField SXDPropName](#) 439
[SXAddl SXCCacheField SXDSxrmitmCount](#) 439
[SXAddl SXCCacheItem SXDEnd](#) 440
[SXAddl SXCCacheItem SXDIId](#) 440
[SXAddl SXCCacheItem SXDIitmMpMapCount](#) 440
[SXAddl SXCCacheItem SXDIitmMpropMap](#) 441
[SXAddl SXCCacheItem SXDSxrmitmDisp](#) 441
[SXAddl SXCFIELD SXDEnd](#) 442
[SXAddl SXCFIELD SXDIId](#) 442
[SXAddl SXCFIELD SXDVer10Info](#) 442
[SXAddl SXCFIELD12 SXDAutoshow](#) 443
[SXAddl SXCFIELD12 SXDIId](#) 444
[SXAddl SXCFIELD12 SXDISXTH](#) 444
[SXAddl SXCFIELD12 SXDMemberCaption](#) 445
[SXAddl SXCFIELD12 SXDVer12Info](#) 445
[SXAddl SXCFIELD12 SXDVerUpdInv](#) 446
[SXAddl SXCGroup SXDEnd](#) 446
[SXAddl SXCGroup SXDGrpInfo](#) 447
[SXAddl SXCGroup SXDIId](#) 448
[SXAddl SXCGroup SXDMember](#) 448
[SXAddl SXCGrpLevel SXDEnd](#) 449
[SXAddl SXCGrpLevel SXDGrpLevelInfo](#) 449
[SXAddl SXCGrpLevel SXDIId](#) 450
[SXAddl SXCHierarchy SXDDisplayFolder](#) 450
[SXAddl SXCHierarchy SXDEnd](#) 451
[SXAddl SXCHierarchy SXDFilterMember](#) 451
[SXAddl SXCHierarchy SXDFilterMember12](#) 452
[SXAddl SXCHierarchy SXDIIconSet](#) 453
[SXAddl SXCHierarchy SXDIId](#) 453
[SXAddl SXCHierarchy SXDIInfo12](#) 454
[SXAddl SXCHierarchy SXDKPIGoal](#) 455
[SXAddl SXCHierarchy SXDKPIStatus](#) 455
[SXAddl SXCHierarchy SXDKPITime](#) 455
[SXAddl SXCHierarchy SXDKPItrend](#) 456
[SXAddl SXCHierarchy SXDKPIValue](#) 456
[SXAddl SXCHierarchy SXDKPIWeight](#) 457
[SXAddl SXCHierarchy SXDMeasureGrp](#) 457
[SXAddl SXCHierarchy SXDParentKPI](#) 458
[SXAddl SXCHierarchy SXDProperty](#) 458
[SXAddl SXCHierarchy SXDSXSetParentUnique](#) 460
[SXAddl SXCHierarchy SXDUserCaption](#) 460
[SXAddl SXCHierarchy SXDVerUpdInv](#) 460
[SXAddl SXCOsi SXDEnd](#) 461
[SXAddl SXCOsi SXDIId](#) 461
[SXAddl SXCQuery SXDEnd](#) 461
[SXAddl SXCQuery SXDReconnCond](#) 462
[SXAddl SXCQuery SXDSrcConnFile](#) 463
[SXAddl SXCQuery SXDSrcDataFile](#) 463
[SXAddl SXCQuery SXDXMLSource](#) 463
[SXAddl SXCSXCondFmt SXDEnd](#) 464
[SXAddl SXCSXCondFmt SXDSXCondFmt](#) 464
[SXAddl SXCSXCondFmts SXDEnd](#) 465
[SXAddl SXCSXCondFmts SXDIId](#) 466
[SXAddl SXCSXDH SXDEnd](#) 466
[SXAddl SXCSXDH SXDIId](#) 467
[SXAddl SXCSXDH SXDSxdlh](#) 467
[SXAddl SXCSXfilt SXDEnd](#) 468
[SXAddl SXCSXfilt SXDIId](#) 469
[SXAddl SXCSXfilt SXDSXfilt](#) 469
[SXAddl SXCSXfilt SXDSXitm](#) 470
[SXAddl SXCSXFilter12 SXDCaption](#) 471
[SXAddl SXCSXFilter12 SXDEnd](#) 472
[SXAddl SXCSXFilter12 SXDIId](#) 472
[SXAddl SXCSXFilter12 SXDSXFilter](#) 472
[SXAddl SXCSXFilter12 SXDSXFilterDesc](#) 474
[SXAddl SXCSXFilter12 SXDSXFilterValue1](#) 474
[SXAddl SXCSXFilter12 SXDSXFilterValue2](#) 474
[SXAddl SXCSXFilter12 SXDXIsFilterValue1](#) 475
[SXAddl SXCSXFilter12 SXDXIsFilterValue2](#) 476
[SXAddl SXCSXFilters12 SXDEnd](#) 476
[SXAddl SXCSXFilters12 SXDIId](#) 477
[SXAddl SXCSXMg SXDEnd](#) 477
[SXAddl SXCSXMg SXDIId](#) 477
[SXAddl SXCSXMg SXDUserCaption](#) 478
[SXAddl SXCSXMgs SXDEnd](#) 478
[SXAddl SXCSXMgs SXDIId](#) 478
[SXAddl SXCSXMgs SXDMGrpSXDHMap](#) 479
[SXAddl SXCSXrule SXDEnd](#) 480
[SXAddl SXCSXrule SXDIId](#) 480
[SXAddl SXCSXrule SXDSXrule](#) 480
[SXAddl SXCView SXDCalcMember](#) 483
[SXAddl SXCView SXDCalcMemString](#) 485
[SXAddl SXCView SXDCompactColHdr](#) 485
[SXAddl SXCView SXDCompactRwHdr](#) 486
[SXAddl SXCView SXDEnd](#) 486
[SXAddl SXCView SXDIId](#) 487
[SXAddl SXCView SXDSXPiIvmb](#) 487
[SXAddl SXCView SXDTableStyleClient](#) 488
[SXAddl SXCView SXDVer10Info](#) 488
[SXAddl SXCView SXDVer12Info](#) 490
[SXAddl SXCView SXDVerUpdInv](#) 492
[SXAddl SXCAutoSort SXDEnd](#) 432
[SXAddl SXCAutoSort SXDIId](#) 432
[SXAddl SXCCache SXDEnd](#) 433
[SXAddl SXCCache SXDIId](#) 433
[SXAddl SXCCache SXDIInfo12](#) 433
[SXAddl SXCCache SXDIInvRefreshReal](#) 434
[SXAddl SXCCache SXDVer10Info](#) 434
[SXAddl SXCCache SXDVerSxMacro](#) 435
[SXAddl SXCCache SXDVerUpdInv](#) 436
[SXAddl SXCCacheField SXDCaption](#) 436
[SXAddl SXCCacheField SXDEnd](#) 436
[SXAddl SXCCacheField SXDIId](#) 437
[SXAddl SXCCacheField SXDIfdbMempropMap](#) 437
[SXAddl SXCCacheField SXDIfdbMpMapCount](#) 438
[SXAddl SXCCacheField SXDProperty](#) 438

[SXAddl SXCCacheField SXDPropName](#) 439
[SXAddl SXCCacheField SXDSxrmitmCount](#) 439
[SXAddl SXCCacheItem SXDEnd](#) 440
[SXAddl SXCCacheItem SXDIId](#) 440
[SXAddl SXCCacheItem SXDIitmMpMapCount](#) 440
[SXAddl SXCCacheItem SXDIitmMpropMap](#) 441
[SXAddl SXCCacheItem SXDSxrmitmDisp](#) 441
[SXAddl SXCFIELD SXDEnd](#) 442
[SXAddl SXCFIELD SXDIId](#) 442
[SXAddl SXCFIELD SXDVer10Info](#) 442
[SXAddl SXCFIELD12 SXDAutoshow](#) 443
[SXAddl SXCFIELD12 SXDEnd](#) 443
[SXAddl SXCFIELD12 SXDIId](#) 444
[SXAddl SXCFIELD12 SXDISXTH](#) 444
[SXAddl SXCFIELD12 SXDMemberCaption](#) 445
[SXAddl SXCFIELD12 SXDVer12Info](#) 445
[SXAddl SXCFIELD12 SXDVerUpdInv](#) 446
[SXAddl SXCGROUP SXDEnd](#) 446
[SXAddl SXCGROUP SXDGrpInfo](#) 447
[SXAddl SXCGROUP SXDIId](#) 448
[SXAddl SXCGROUP SXDMember](#) 448
[SXAddl SXCGrpLevel SXDEnd](#) 449
[SXAddl SXCGrpLevel SXDGrpLevelInfo](#) 449
[SXAddl SXCGrpLevel SXDIId](#) 450
[SXAddl SXCHierarchy SXDDisplayFolder](#) 450
[SXAddl SXCHierarchy SXDEnd](#) 451
[SXAddl SXCHierarchy SXDFilterMember](#) 451
[SXAddl SXCHierarchy SXDFilterMember12](#) 452
[SXAddl SXCHierarchy SXDIIconSet](#) 453
[SXAddl SXCHierarchy SXDIId](#) 453
[SXAddl SXCHierarchy SXDIInfo12](#) 454
[SXAddl SXCHierarchy SXDKPIGoal](#) 455
[SXAddl SXCHierarchy SXDKPIStatus](#) 455
[SXAddl SXCHierarchy SXDKPITime](#) 455
[SXAddl SXCHierarchy SXDKPITrend](#) 456
[SXAddl SXCHierarchy SXDKPIValue](#) 456
[SXAddl SXCHierarchy SXDKPIWeight](#) 457
[SXAddl SXCHierarchy SXDMeasureGrp](#) 457
[SXAddl SXCHierarchy SXDParentKPI](#) 458
[SXAddl SXCHierarchy SXDProperty](#) 458
[SXAddl SXCHierarchy SXDSXSetParentUnique](#) 460
[SXAddl SXCHierarchy SXDUserCaption](#) 460
[SXAddl SXCHierarchy SXDVerUpdInv](#) 460
[SXAddl SXCQsi SXDEnd](#) 461
[SXAddl SXCQsi SXDIId](#) 461
[SXAddl SXCQuery SXDEnd](#) 461
[SXAddl SXCQuery SXDReconnCond](#) 462
[SXAddl SXCQuery SXDSrcConnFile](#) 463
[SXAddl SXCQuery SXDSrcDataFile](#) 463
[SXAddl SXCQuery SXDXMLSource](#) 463
[SXAddl SXCSXCondFmt SXDEnd](#) 464
[SXAddl SXCSXCondFmt SXDSXCondFmt](#) 464
[SXAddl SXCSXCondFmts SXDEnd](#) 465
[SXAddl SXCSXCondFmts SXDIId](#) 466
[SXAddl SXCSXDH SXDEnd](#) 466
[SXAddl SXCSXDH SXDIId](#) 467
[SXAddl SXCSXDH SXDSxdh](#) 467
[SXAddl SXCSXfilt SXDEnd](#) 468
[SXAddl SXCSXfilt SXDIId](#) 469
[SXAddl SXCSXfilt SXDSXfilt](#) 469
[SXAddl SXCSXfilt SXDSXitm](#) 470
[SXAddl SXCSXFilter12 SXDCaption](#) 471
[SXAddl SXCSXFilter12 SXDEnd](#) 472
[SXAddl SXCSXFilter12 SXDIId](#) 472
[SXAddl SXCSXFilter12 SXDSXFilter](#) 472
[SXAddl SXCSXFilter12 SXDSXFilterDesc](#) 474
[SXAddl SXCSXFilter12 SXDSXFilterValue1](#) 474
[SXAddl SXCSXFilter12 SXDSXFilterValue2](#) 474
[SXAddl SXCSXFilter12 SXDXIsFilter](#) 475
[SXAddl SXCSXFilter12 SXDXIsFilterValue1](#) 475
[SXAddl SXCSXFilter12 SXDXIsFilterValue2](#) 476
[SXAddl SXCSXFilters12 SXDEnd](#) 476
[SXAddl SXCSXFilters12 SXDIId](#) 477
[SXAddl SXCSXMq SXDEnd](#) 477
[SXAddl SXCSXMq SXDIId](#) 477
[SXAddl SXCSXMq SXDUserCaption](#) 478
[SXAddl SXCSXMgs SXDEnd](#) 478
[SXAddl SXCSXMgs SXDIId](#) 478
[SXAddl SXCSXMgs SXDMGrpSXDHMap](#) 479
[SXAddl SXCSXrule SXDEnd](#) 480
[SXAddl SXCSXrule SXDIId](#) 480
[SXAddl SXCSXrule SXDSXrule](#) 480
[SXAddl SXCVIEW SXDCalcMember](#) 483
[SXAddl SXCVIEW SXDCalcMemString](#) 485
[SXAddl SXCVIEW SXDCompactColHdr](#) 485
[SXAddl SXCVIEW SXDCompactRwHdr](#) 486
[SXAddl SXCVIEW SXDEnd](#) 486
[SXAddl SXCVIEW SXDIId](#) 487
[SXAddl SXCVIEW SXDSXPiIvmb](#) 487
[SXAddl SXCVIEW SXDTableStyleClient](#) 488
[SXAddl SXCVIEW SXDVer10Info](#) 488
[SXAddl SXCVIEW SXDVer12Info](#) 490
[SXAddl SXCVIEW SXDVerUpdInv](#) 492
[SxAddl SXDEnd](#) 861
[SxAddl SXDVerUpdInv](#) 861
[SxAddl SXString](#) 861
[SXAddlHdr](#) 862
[SXAxis](#) 862
[SxBool](#) 493
[SXDB](#) 493
[SXDBB](#) 494
[SXDBEx](#) 494
[SXDI](#) 495
[SXDItr](#) 497
[SxDXF](#) 497
[SxErr](#) 498
[SXEx](#) 498
[SXEZDoper](#) 862
[SXFDB](#) 501
[SXFDBType](#) 504
[SxFilt](#) 504
[SxFmla](#) 505
[SxFormat](#) 506
[SxFormula](#) 506
[SxFT](#) 863
[SxInt](#) 506
[SxIsxoper](#) 507
[Sxitm](#) 507
[SxIvd](#) 508
[SxIvdCol](#) 867
[SxIvdRw](#) 867
[SXLI](#) 509
[SXLIItem](#) 867
[SxName](#) 509
[SxNil](#) 510
[SXNum](#) 510
[SXPair](#) 510
[SXPI](#) 511
[SXPI Item](#) 870
[SXPIEx](#) 512

[SXRng](#) 512
[SxRule](#) 514
[SxSelect](#) 516
[SXStreamID](#) 518
[SXString](#) 518
[SXTbl](#) 518
[SxTbpg](#) 519
[SXTBRGIITM](#) 520
[SXTH](#) 520
[Sxvd](#) 523
[SXVDEx](#) 527
[SXVDEx_Opt](#) 870
[SXVDTEx](#) 530
[SXVI](#) 531
[SxView](#) 533
[SxView9Save](#) 871
[SxViewEx](#) 535
[SxViewEx9](#) 536
[SxViewLink](#) 537
[SXVIFlags](#) 871
[SXVS](#) 538
[Sync](#) 538

T

[TabId](#) 872
[TabIndex](#) 872
[Table](#) 538
[Table example](#) 936
[Table styles](#) 159
[Table: Feathdr11 example](#) 936
[Table: Feature11 example](#) 937
[TableFeatureType](#) 872
[TableStyle](#) 540
[TableStyleElement](#) 541
[TableStyles](#) 544
[Tag_Fn_MDX](#) 876
[TBC](#) 921
[TBCCmd](#) 922
[Template](#) 545
[Text](#) 545
[Text import connections](#) 163
[TextPropsStream](#) 550
[TextPropsStreamChecksumData](#) 877
[Theme](#) 552
[Tick](#) 552
Tokens
 [control](#) 82
 [display](#) 82
 [mem](#) 82
 [operand](#) 81
 [operator](#) 81
[Top10FT](#) 879
[TopMargin](#) 555
[Tracking changes](#) 1095
[Trendline](#) 100
[Ts](#) 879
[TxO](#) 556
[TxOLastRun](#) 879
[TxORuns](#) 880
[TxtQry](#) 558
[TxtWf](#) 880

U

[Uncalced](#) 560
[Underline](#) 881
[Units](#) 560
[User log](#) 167
[User names stream](#) 67
[UserBView](#) 560
[UserSViewBegin](#) 564
[UserSViewBegin_Chart](#) 567
[UserSViewEnd](#) 569
[UsesELFs](#) 569
[UsrChk](#) 569
[UsrExcl](#) 570
[UsrInfo](#) 571

V

[Value metadata](#) 104
[ValueRange](#) 571
[VBA storage](#) 67
[VCenter](#) 574
[Vendor-extensible fields](#) 55
[Versioning](#) 54
[VertAlign](#) 881
[VertBrk](#) 881
[VerticalPageBreaks](#) 574
[Viewer content stream](#) 67
[VirtualPath](#) 881

W

[Web connections](#) 163
[WebPub](#) 574
[WebPubString](#) 883
[Window1](#) 577
[Window2](#) 578
[WinProtect](#) 580
[WOpt](#) 581
[Workbook example](#) 995
[Workbook stream](#) 67
[Workbook: BOF 1 example](#) 996
[Workbook: BookBool example](#) 1000
[Workbook: BookExt example](#) 1009
[Workbook: BoundSheet8 1 example](#) 1006
[Workbook: BoundSheet8 2 example](#) 1006
[Workbook: BoundSheet8 3 example](#) 1007
[Workbook: BuiltInFnGroupCount example](#) 998
[Workbook: CalcPrecision example](#) 1000
[Workbook: Country example](#) 1007
[Workbook: Date1904 example](#) 1000
[Workbook: DBCell example](#) 1026
[Workbook: DefaultRowHeight example](#) 1013
[Workbook: DefColWidth example](#) 1016
[Workbook: Dimensions example](#) 1016
[Workbook: EOF 1 example](#) 1011
[Workbook: EOF 2 example \(section 3.9.22 1011, section 3.9.41 1030\)](#)
[Workbook: ExtSST example](#) 1008
[Workbook: Font example](#) 1001
[Workbook: Format example](#) 1002
[Workbook: Formula example](#) 1023
[Workbook: HideObj example](#) 1000
[Workbook: Index example](#) 1012
[Workbook: LabelSst 1 example](#) 1020
[Workbook: LabelSst 2 example](#) 1022
[Workbook: PhoneticInfo example](#) 1029

[Workbook: RecalcId example](#) 1008
[Workbook: RK example](#) 1021
[Workbook: Row 1 example](#) 1017
[Workbook: Row 2 example](#) 1018
[Workbook: Row 3 example](#) 1019
[Workbook: Row 4 example](#) 1019
[Workbook: RRTabId example](#) 997
[Workbook: Selection example](#) 1028
[Workbook: Setup example](#) 1014
[Workbook: SST example](#) 1008
[Workbook: Style example](#) 1005
[Workbook: Window1 example](#) 998
[Workbook: Window2 example](#) 1026
[Workbook: WsBool example](#) 1013
[Workbook: XF example](#) 1003
[WriteAccess](#) 582
[WriteProtect](#) 583
[WsBool](#) 583

X

XCB structures
[CTB](#) 920
[CTBS](#) 919
[CTBWRAPPER](#) 919
[TBC](#) 921
[TBCCmd](#) 922
[XColorType](#) 884
[XCT](#) 584
[XF](#) 584
[XFCRC](#) 585
[XFExt](#) 585
[XFExtGradient](#) 884
[XFExtNoFRT](#) 885
[XFIndex](#) 885
[XFProp](#) 887
[XFPropBorder](#) 889
[XFPropColor](#) 889
[XFPropGradient](#) 890
[XFPropGradientStop](#) 891
[XFProps](#) 891
[XFPropTextRotation](#) 892
[XFs](#) 157
[XLNameUnicodeString](#) 892
[XlsFilter_Criteria](#) 893
[XlsFilter_Top10](#) 894
[XLUnicodeRichExtendedString](#) 895
[XLUnicodeString](#) 896
[XLUnicodeStringMin2](#) 897
[XLUnicodeStringNoCch](#) 897
[XLUnicodeStringSegmented](#) 897
[XLUnicodeStringSegmentedRTD](#) 898
[XLUnicodeStringSegmentedSXAddl](#) 898
[XML signatures storage](#) 75
[XML stream](#) 75
[XmlTkBackWallThicknessFrnt](#) 899
[XmlTkBaseTimeUnitFrnt](#) 899
[XmlTkBlob](#) 900
[XmlTkBool](#) 900
[XmlTkChain](#) 901
[XmlTkColorMappingOverride](#) 903
[XmlTkDispBlanksAsFrnt](#) 903
[XmlTkDouble](#) 904
[XmlTkDWord](#) 904
[XmlTkEnd](#) 905

[XmlTkEndSurface](#) 905
[XmlTkFloorThicknessFrnt](#) 905
[XmlTkFormatCodeFrnt](#) 906
[XmlTkHeader](#) 906
[XmlTkHeightPercent](#) 906
[XmlTkLogBaseFrnt](#) 907
[XmlTkMajorUnitFrnt](#) 907
[XmlTkMajorUnitTypeFrnt](#) 907
[XmlTkMaxFrnt](#) 908
[XmlTkMinFrnt](#) 908
[XmlTkMinorUnitFrnt](#) 909
[XmlTkMinorUnitTypeFrnt](#) 909
[XmlTkNoMultiLvlLbl](#) 910
[XmlTkOverlay](#) 910
[XmlTkPerspectiveFrnt](#) 911
[XmlTkPieComboFrom12Frnt](#) 911
[XmlTkRANGAxOffFrnt](#) 911
[XmlTkRotXFrt](#) 912
[XmlTkRotYFrt](#) 912
[XmlTkShowDLblsOverMax](#) 912
[XmlTkSpb](#) 913
[XmlTkStart](#) 913
[XmlTkStartSurface](#) 913
[XmlTkString](#) 914
[XmlTkStyle](#) 914
[XmlTkSymbolFrnt](#) 914
[XmlTkThemeOverride](#) 915
[XmlTkTickLabelPositionFrnt](#) 915
[XmlTkTickLabelSkipFrnt](#) 916
[XmlTkTickMarkSkipFrnt](#) 916
[XmlTkToken](#) 916
[XmlTkTpb](#) 917
[Xnum](#) 917
[XORObfuscation](#) 917
[XTI](#) 917
[XtiIndex](#) 832

Y

[YMult](#) 586