

[MS-WSSFO3]: Windows SharePoint Services (WSS): File Operations Database Communications Version 3 Protocol

Intellectual Property Rights Notice for Open Specifications Documentation

- **Technical Documentation.** Microsoft publishes Open Specifications documentation for protocols, file formats, languages, standards as well as overviews of the interaction among each of these technologies.
- **Copyrights.** This documentation is covered by Microsoft copyrights. Regardless of any other terms that are contained in the terms of use for the Microsoft website that hosts this documentation, you may make copies of it in order to develop implementations of the technologies described in the Open Specifications and may distribute portions of it in your implementations using these technologies or your documentation as necessary to properly document the implementation. You may also distribute in your implementation, with or without modification, any schema, IDL's, or code samples that are included in the documentation. This permission also applies to any documents that are referenced in the Open Specifications.
- **No Trade Secrets.** Microsoft does not claim any trade secret rights in this documentation.
- **Patents.** Microsoft has patents that may cover your implementations of the technologies described in the Open Specifications. Neither this notice nor Microsoft's delivery of the documentation grants any licenses under those or any other Microsoft patents. However, a given Open Specification may be covered by Microsoft [Open Specification Promise](#) or the [Community Promise](#). If you would prefer a written license, or if the technologies described in the Open Specifications are not covered by the Open Specifications Promise or Community Promise, as applicable, patent licenses are available by contacting iplg@microsoft.com.
- **Trademarks.** The names of companies and products contained in this documentation may be covered by trademarks or similar intellectual property rights. This notice does not grant any licenses under those rights. For a list of Microsoft trademarks, visit www.microsoft.com/trademarks.
- **Fictitious Names.** The example companies, organizations, products, domain names, email addresses, logos, people, places, and events depicted in this documentation are fictitious. No association with any real company, organization, product, domain name, email address, logo, person, place, or event is intended or should be inferred.

Reservation of Rights. All other rights are reserved, and this notice does not grant any rights other than specifically described above, whether by implication, estoppel, or otherwise.

Tools. The Open Specifications do not require the use of Microsoft programming tools or programming environments in order for you to develop an implementation. If you have access to Microsoft programming tools and environments you are free to take advantage of them. Certain Open Specifications are intended for use in conjunction with publicly available standard

specifications and network programming art, and assumes that the reader either is familiar with the aforementioned material or has immediate access to it.

Revision Summary

| Date | Revision History | Revision Class | Comments |
|------------|------------------|----------------|--|
| 01/20/2012 | 0.1 | New | Released new document. |
| 04/11/2012 | 0.1 | No change | No changes to the meaning, language, or formatting of the technical content. |
| 07/16/2012 | 0.1 | No change | No changes to the meaning, language, or formatting of the technical content. |
| 09/12/2012 | 0.1 | No change | No changes to the meaning, language, or formatting of the technical content. |
| 10/08/2012 | 1.0 | Major | Significantly changed the technical content. |
| 02/11/2013 | 2.0 | Major | Significantly changed the technical content. |
| 07/30/2013 | 2.0 | No change | No changes to the meaning, language, or formatting of the technical content. |
| 11/18/2013 | 2.0 | No change | No changes to the meaning, language, or formatting of the technical content. |
| 02/10/2014 | 2.1 | Minor | Clarified the meaning of the technical content. |
| 04/30/2014 | 2.2 | Minor | Clarified the meaning of the technical content. |
| 07/31/2014 | 2.3 | Minor | Clarified the meaning of the technical content. |

Table of Contents

| | |
|---|-----------|
| 1 Introduction | 16 |
| 1.1 Glossary | 16 |
| 1.2 References | 20 |
| 1.2.1 Normative References | 20 |
| 1.2.2 Informative References | 21 |
| 1.3 Overview | 21 |
| 1.3.1 File Operations | 21 |
| 1.3.2 User and Group Operations | 22 |
| 1.4 Relationship to Other Protocols | 22 |
| 1.5 Prerequisites/Preconditions | 23 |
| 1.6 Applicability Statement | 23 |
| 1.7 Versioning and Capability Negotiation | 23 |
| 1.8 Vendor-Extensible Fields | 23 |
| 1.9 Standards Assignments | 23 |
| 2 Messages | 24 |
| 2.1 Transport | 24 |
| 2.2 Common Data Types | 24 |
| 2.2.1 Simple Data Types and Enumerations | 24 |
| 2.2.1.1 Simple Data Types | 24 |
| 2.2.1.1.1 Content Type Identifier | 24 |
| 2.2.1.1.2 Document Identifier | 24 |
| 2.2.1.1.3 Event Receiver Identifier | 24 |
| 2.2.1.1.4 Feature Identifier | 24 |
| 2.2.1.1.5 List Identifier | 24 |
| 2.2.1.1.6 List Item Identifier | 24 |
| 2.2.1.1.7 Role Identifier | 24 |
| 2.2.1.1.8 Scope Identifier | 25 |
| 2.2.1.1.9 Site Collection Identifier | 25 |
| 2.2.1.1.10 Site Group Identifier | 25 |
| 2.2.1.1.11 Site Identifier | 25 |
| 2.2.1.1.12 SystemID | 25 |
| 2.2.1.1.13 User Identifier | 25 |
| 2.2.1.1.14 View Identifier | 25 |
| 2.2.1.1.15 Web Part Identifier | 25 |
| 2.2.1.1.16 Workflow Identifier | 26 |
| 2.2.1.1.17 tPermMask | 26 |
| 2.2.1.2 Enumerations | 26 |
| 2.2.1.2.1 Attachments Flag | 26 |
| 2.2.1.2.2 Audit Item Type | 26 |
| 2.2.1.2.3 Calendar Type | 26 |
| 2.2.1.2.4 Collation Order Enumeration | 27 |
| 2.2.1.2.5 Event Host Type | 29 |
| 2.2.1.2.6 Event Receiver Type | 29 |
| 2.2.1.2.7 Excluded Folder Type | 31 |
| 2.2.1.2.8 LinkDynamic Type | 31 |
| 2.2.1.2.9 LinkSecurity Type | 32 |
| 2.2.1.2.10 LinkType Types | 32 |
| 2.2.1.2.11 List Base Type | 33 |
| 2.2.1.2.12 List Server Template | 33 |

| | | |
|------------|---|----|
| 2.2.1.2.13 | Moderation Status | 36 |
| 2.2.1.2.14 | Page Type | 36 |
| 2.2.1.2.15 | Redirect Type..... | 37 |
| 2.2.1.2.16 | Role Definition Type..... | 37 |
| 2.2.1.2.17 | Virus Status..... | 37 |
| 2.2.1.2.18 | App Principal Permissions Enumeration | 38 |
| 2.2.2 | Bit Fields and Flag Structures..... | 38 |
| 2.2.2.1 | Audit Flags..... | 38 |
| 2.2.2.2 | Configuration Object Status | 39 |
| 2.2.2.3 | Doc Flags | 39 |
| 2.2.2.4 | Document Store Type | 40 |
| 2.2.2.5 | List Flags..... | 41 |
| 2.2.2.6 | Publishing Level Type..... | 44 |
| 2.2.2.7 | Put Flags Type..... | 44 |
| 2.2.2.8 | Rename Flags | 45 |
| 2.2.2.9 | Site Collection Flags..... | 46 |
| 2.2.2.10 | Site Collection Upgrade Flags | 47 |
| 2.2.2.11 | Site Property Flags..... | 47 |
| 2.2.2.12 | UserInfo tp_flags | 48 |
| 2.2.2.13 | View Flags | 49 |
| 2.2.2.14 | Workdays Flag..... | 50 |
| 2.2.2.15 | WSS Rights Mask..... | 50 |
| 2.2.3 | Binary Structures | 53 |
| 2.2.3.1 | Calendar View Options Type..... | 53 |
| 2.2.3.2 | External Group Token | 54 |
| 2.2.3.3 | Token Group Offset and Attributes..... | 55 |
| 2.2.3.4 | Token Groups..... | 56 |
| 2.2.3.5 | WSS ACE..... | 56 |
| 2.2.3.6 | WSS ACL Format | 57 |
| 2.2.3.7 | WSS External Group Map Cache Format | 57 |
| 2.2.3.8 | WSS Compressed Structures..... | 58 |
| 2.2.3.9 | WSS External Group Record..... | 59 |
| 2.2.3.10 | WSS User Token | 59 |
| 2.2.4 | Result Sets | 60 |
| 2.2.4.1 | ACL and Permission Result Set | 60 |
| 2.2.4.2 | Custom Actions From Scope Result Set | 60 |
| 2.2.4.3 | Domain Group Cache BEDS Update Result Set | 61 |
| 2.2.4.4 | Domain Group Cache Versions Result Set | 61 |
| 2.2.4.5 | Domain Group Cache WFE Update Result Set | 62 |
| 2.2.4.6 | Document Content Metadata Result Set..... | 62 |
| 2.2.4.7 | Document Content Stream Result Set | 64 |
| 2.2.4.8 | Document Metadata Result Set..... | 64 |
| 2.2.4.9 | Document Version Metadata Result Set | 68 |
| 2.2.4.10 | Empty Result Set | 73 |
| 2.2.4.11 | Event Receivers Result Set..... | 73 |
| 2.2.4.12 | Individual URL Security Result Set | 75 |
| 2.2.4.13 | Link Information Result Set..... | 77 |
| 2.2.4.14 | List Metadata Result Set | 78 |
| 2.2.4.15 | List Web Parts Result Set..... | 82 |
| 2.2.4.16 | NULL Individual URL Security Result Set | 83 |
| 2.2.4.17 | NULL Unique Permissions Result Set..... | 84 |
| 2.2.4.18 | Object ID Result Set..... | 85 |
| 2.2.4.19 | Principal User Information Result Set | 85 |

| | | |
|-------------|--|-----|
| 2.2.4.20 | Server Time Result Set | 85 |
| 2.2.4.21 | Single Doc Link Information Result Set | 86 |
| 2.2.4.22 | Site Audit Mask Result Set | 87 |
| 2.2.4.23 | Site Feature List Result Set | 87 |
| 2.2.4.24 | Site Metadata Result Set | 87 |
| 2.2.4.25 | Site MetaInfo Result Set | 93 |
| 2.2.4.26 | Unique Permissions Result Set | 94 |
| 2.2.4.27 | URL Result Set | 94 |
| 2.2.4.28 | List Related Fields Result Set | 94 |
| 2.2.4.29 | App Principal Information Result Set | 95 |
| 2.2.4.30 | App Principal Permissions Result Set | 95 |
| 2.2.5 | SQL Structures | 96 |
| 2.2.5.1 | Configuration Object | 96 |
| 2.2.5.1.1 | Class | 96 |
| 2.2.5.1.2 | Id | 96 |
| 2.2.5.1.3 | Name | 97 |
| 2.2.5.1.4 | Parent | 97 |
| 2.2.5.1.5 | Status | 97 |
| 2.2.5.1.6 | Version | 97 |
| 2.2.5.1.7 | Properties | 97 |
| 2.2.5.1.7.1 | Alternate URL Collection | 98 |
| 2.2.5.1.7.2 | Content Database | 98 |
| 2.2.5.1.7.3 | Web Application | 99 |
| 2.2.5.2 | Dependencies | 100 |
| 2.2.6 | Tables and Views | 100 |
| 2.2.6.1 | AllDocs Table | 100 |
| 2.2.6.2 | AllUserData Table | 107 |
| 2.2.6.3 | Docs View | 178 |
| 2.2.6.4 | GroupMembership Table | 178 |
| 2.2.6.5 | Sec_SiteGroupsView | 179 |
| 2.2.6.6 | AllSites Table | 182 |
| 2.2.6.7 | Sites View | 186 |
| 2.2.6.8 | UserData View | 186 |
| 2.2.6.9 | UserDataVersioned View | 186 |
| 2.2.6.10 | UserInfo Table | 186 |
| 2.2.6.11 | WebMembers | 189 |
| 2.2.6.12 | Versions | 189 |
| 2.2.7 | XML Structures | 190 |
| 2.2.7.1 | Namespaces | 190 |
| 2.2.7.2 | Simple Types | 190 |
| 2.2.7.2.1 | FALSE_Case_Insensitive_ElseAnything | 190 |
| 2.2.7.2.2 | FieldInternalType | 190 |
| 2.2.7.2.3 | FieldAggregationAttribute | 192 |
| 2.2.7.2.4 | FieldRefType | 193 |
| 2.2.7.2.5 | FieldRichTextMode | 193 |
| 2.2.7.2.6 | IMEMode | 194 |
| 2.2.7.2.7 | IntPositive | 194 |
| 2.2.7.2.8 | JoinType | 194 |
| 2.2.7.2.9 | TextDirection | 194 |
| 2.2.7.2.10 | TRUE_If_Present | 195 |
| 2.2.7.2.11 | TRUEFALSE | 195 |
| 2.2.7.2.12 | TRUE_Case_Sensitive_ElseAnything | 195 |
| 2.2.7.2.13 | UniqueIdentifierWithBracesUppercase | 195 |

| | | |
|--------------|-------------------------------------|-----|
| 2.2.7.2.14 | UniqueIdentifierWithOrWithoutBraces | 196 |
| 2.2.7.2.15 | RelationshipDeleteBehaviorAttribute | 196 |
| 2.2.7.3 | Complex Types | 196 |
| 2.2.7.3.1 | CHOICEDEFINITION | 196 |
| 2.2.7.3.1.1 | Schema | 196 |
| 2.2.7.3.1.2 | Attributes | 197 |
| 2.2.7.3.1.3 | Child Elements | 197 |
| 2.2.7.3.2 | CHOICEDEFINITIONS | 197 |
| 2.2.7.3.2.1 | Schema | 197 |
| 2.2.7.3.2.2 | Attributes | 197 |
| 2.2.7.3.2.3 | Child Elements | 197 |
| 2.2.7.3.3 | FieldDefinition | 197 |
| 2.2.7.3.3.1 | Schema | 197 |
| 2.2.7.3.3.2 | Attributes | 201 |
| 2.2.7.3.3.3 | Child Elements | 210 |
| 2.2.7.3.4 | FieldDefinitionDatabase | 211 |
| 2.2.7.3.4.1 | Schema | 211 |
| 2.2.7.3.4.2 | Attributes | 211 |
| 2.2.7.3.4.3 | Child Elements | 211 |
| 2.2.7.3.5 | FieldDefinitionDatabaseWithVersion | 211 |
| 2.2.7.3.5.1 | Schema | 211 |
| 2.2.7.3.5.2 | Attributes | 211 |
| 2.2.7.3.5.3 | Child Elements | 211 |
| 2.2.7.3.6 | FieldDefinitionTP | 212 |
| 2.2.7.3.6.1 | Schema | 212 |
| 2.2.7.3.6.2 | Attributes | 212 |
| 2.2.7.3.6.3 | Child Elements | 212 |
| 2.2.7.3.7 | FieldParserRef | 212 |
| 2.2.7.3.7.1 | Schema | 212 |
| 2.2.7.3.7.2 | Attributes | 212 |
| 2.2.7.3.7.3 | Child Elements | 213 |
| 2.2.7.3.8 | FieldParserRefs | 213 |
| 2.2.7.3.8.1 | Schema | 213 |
| 2.2.7.3.8.2 | Attributes | 213 |
| 2.2.7.3.8.3 | Child Elements | 213 |
| 2.2.7.3.9 | FieldRefDefinitionField | 213 |
| 2.2.7.3.9.1 | Schema | 213 |
| 2.2.7.3.9.2 | Attributes | 213 |
| 2.2.7.3.9.3 | Child Elements | 214 |
| 2.2.7.3.10 | FieldRefDefinitionIndex | 214 |
| 2.2.7.3.10.1 | Schema | 214 |
| 2.2.7.3.10.2 | Attributes | 214 |
| 2.2.7.3.10.3 | Child Elements | 214 |
| 2.2.7.3.11 | FieldRefDefinitionTP | 214 |
| 2.2.7.3.11.1 | Schema | 214 |
| 2.2.7.3.11.2 | Attributes | 215 |
| 2.2.7.3.11.3 | Child Elements | 215 |
| 2.2.7.3.12 | IndexDefinitionTP | 215 |
| 2.2.7.3.12.1 | Schema | 215 |
| 2.2.7.3.12.2 | Attributes | 215 |
| 2.2.7.3.12.3 | Child Elements | 215 |
| 2.2.7.3.13 | MAPPINGDEFINITION | 215 |
| 2.2.7.3.13.1 | Schema | 215 |

| | | |
|--------------|--|------------|
| 2.2.7.3.13.2 | Attributes | 215 |
| 2.2.7.3.13.3 | Child Elements | 216 |
| 2.2.7.3.14 | MAPPINGDEFINITIONS | 216 |
| 2.2.7.3.14.1 | Schema | 216 |
| 2.2.7.3.14.2 | Attributes | 216 |
| 2.2.7.3.14.3 | Child Elements | 216 |
| 2.2.7.4 | Elements | 216 |
| 2.2.7.5 | Attributes | 216 |
| 2.2.7.6 | Groups | 216 |
| 2.2.7.7 | Attribute Groups | 216 |
| 2.2.8 | User-Defined Table Types | 216 |
| 2.2.8.1 | tvpsBNMetadata | 216 |
| 2.2.8.2 | tvpsBNMetadata2 | 217 |
| 2.2.8.3 | tvpsStreamData | 217 |
| 3 | Protocol Details | 219 |
| 3.1 | Back-End Database Server Details | 219 |
| 3.1.1 | Abstract Data Model | 219 |
| 3.1.2 | Timers | 220 |
| 3.1.3 | Initialization | 220 |
| 3.1.4 | Higher-Layer Triggered Events | 220 |
| 3.1.5 | Message Processing Events and Sequencing Rules | 220 |
| 3.1.5.1 | fn_GetFullUrl | 229 |
| 3.1.5.2 | proc_AddBuildDependency | 230 |
| 3.1.5.3 | proc_AddDocument | 230 |
| 3.1.5.3.1 | Site List for Normalization Result Set | 234 |
| 3.1.5.3.2 | Checkout Information Result Set | 235 |
| 3.1.5.4 | proc_AddListItem | 235 |
| 3.1.5.5 | proc_ChangeLevelForDoc | 241 |
| 3.1.5.6 | proc_CheckRbsInstalled | 242 |
| 3.1.5.7 | proc_CheckoutDocument | 243 |
| 3.1.5.7.1 | Link Info Single Doc Result Set | 245 |
| 3.1.5.7.2 | Document Metadata Result Set | 245 |
| 3.1.5.7.3 | Event Receivers Result Set | 246 |
| 3.1.5.7.4 | Audit Mask Result Set | 246 |
| 3.1.5.8 | proc_ClearLinks | 246 |
| 3.1.5.9 | proc_CreateDir | 247 |
| 3.1.5.10 | proc_DeleteAllDocumentVersions | 249 |
| 3.1.5.11 | proc_DeleteDocBuildDependencySet | 251 |
| 3.1.5.12 | proc_DeleteDocumentVersion | 251 |
| 3.1.5.13 | proc_DeleteUrl | 252 |
| 3.1.5.13.1 | Deleted Documents Result Set | 255 |
| 3.1.5.13.2 | Deleted Aliased Lists Result Set | 255 |
| 3.1.5.13.3 | Empty Deleted Aliased Lists Result Set | 256 |
| 3.1.5.14 | proc_DisableRbs | 256 |
| 3.1.5.15 | proc_DirtyDependents | 256 |
| 3.1.5.16 | proc_EnableRbs | 257 |
| 3.1.5.17 | proc_EnumLists | 258 |
| 3.1.5.17.1 | List Information Result Set | 259 |
| 3.1.5.17.2 | Recycle Bin Information Result Set | 263 |
| 3.1.5.17.3 | NULL Result Set | 263 |
| 3.1.5.18 | proc_ReadStream | 263 |
| 3.1.5.18.1 | Document Stream Chunk Result Set | 264 |

| | | |
|-------------|---|-----|
| 3.1.5.19 | proc_FetchDocForHttpGet | 264 |
| 3.1.5.19.1 | HTTP Document Metadata Result Set | 268 |
| 3.1.5.19.2 | Domain Group Cache Versions Result Set | 271 |
| 3.1.5.19.3 | Domain Group Cache BEDS Update Result Set | 271 |
| 3.1.5.19.4 | Domain Group Cache WFE Update Result Set | 272 |
| 3.1.5.19.5 | User Information Result Set | 272 |
| 3.1.5.19.6 | Welcome Page Redirect Information Result Set | 273 |
| 3.1.5.19.7 | Non-Welcome Page Redirect Information Result Set | 273 |
| 3.1.5.19.8 | Document Information (Get) Metadata Result Set | 273 |
| 3.1.5.19.9 | Document Information (Get) Stream Result Set | 274 |
| 3.1.5.19.10 | Site Collection Audit Mask Result Set | 274 |
| 3.1.5.19.11 | List Audit Mask Result Set | 274 |
| 3.1.5.19.12 | Document Build Dependency Set Result Set | 275 |
| 3.1.5.19.13 | Document Build Dependency Metadata Result Set | 275 |
| 3.1.5.19.14 | Site Metadata Result Set | 277 |
| 3.1.5.19.15 | Event Receivers Result Set | 277 |
| 3.1.5.19.16 | Web Event Receiver Result Set | 277 |
| 3.1.5.19.17 | Site Features List Result Set | 277 |
| 3.1.5.19.18 | WebParts Metadata, Personalized Result Set | 278 |
| 3.1.5.19.19 | Web Parts Metadata, Nonpersonalized Result Set | 280 |
| 3.1.5.19.20 | List Metadata Result Set | 282 |
| 3.1.5.19.21 | List Event Receivers Result Set | 282 |
| 3.1.5.19.22 | List Security Information Result Set | 282 |
| 3.1.5.19.23 | SiteCollection Custom Action Result Set | 283 |
| 3.1.5.19.24 | Site Custom Actions Result Set | 283 |
| 3.1.5.19.25 | List Custom Actions Result Set | 283 |
| 3.1.5.19.26 | List Web Parts Result Set | 283 |
| 3.1.5.19.27 | Content Type Order Result Set | 284 |
| 3.1.5.19.28 | Current Folder Scope Result Set | 284 |
| 3.1.5.19.29 | Navigation Context Security Information Result Set | 284 |
| 3.1.5.19.30 | NULL Navigation Context Security Information Result Set | 285 |
| 3.1.5.19.31 | Empty Navigation Context Security Information Result Set | 285 |
| 3.1.5.19.32 | App Principal Information Result Set | 285 |
| 3.1.5.19.33 | App Principal Permissions Result Set | 285 |
| 3.1.5.20 | proc_FetchDocForRead | 285 |
| 3.1.5.20.1 | Subsite List Result Set | 287 |
| 3.1.5.20.2 | Link Info Single Doc Result Set | 288 |
| 3.1.5.20.3 | Document Metadata Result Set | 288 |
| 3.1.5.20.4 | Document Version Metadata Result Set | 288 |
| 3.1.5.20.5 | NULL Result Set | 288 |
| 3.1.5.20.6 | Event Receivers Result Set | 288 |
| 3.1.5.20.7 | List Metadata Result Set | 289 |
| 3.1.5.20.8 | Empty List Result Set | 289 |
| 3.1.5.20.9 | Event Receivers Result Set (1) | 289 |
| 3.1.5.20.10 | Document Information and Content (Read) Metadata Result Set | 289 |
| 3.1.5.20.11 | Document Information and Content (Read) Stream Result Set | 290 |
| 3.1.5.20.12 | Document Version Information and Content Result Set | 290 |
| 3.1.5.20.13 | Document Version Information and Content Stream Result Set | 290 |
| 3.1.5.20.14 | Attachment State Result Set | 290 |
| 3.1.5.20.15 | Audit Mask Result Set | 291 |
| 3.1.5.21 | proc_FetchDocForUpdate | 291 |
| 3.1.5.21.1 | Subsite List Result Set | 293 |
| 3.1.5.21.2 | ACL and Permission Result Set | 293 |

| | | |
|-------------|---|-----|
| 3.1.5.21.3 | Document Metadata Result Set | 293 |
| 3.1.5.21.4 | Document Version Metadata Result Set | 293 |
| 3.1.5.21.5 | NULL Result Set | 293 |
| 3.1.5.21.6 | Event Receivers Result Set | 294 |
| 3.1.5.21.7 | Link Info Single Doc Fixup Result Set | 294 |
| 3.1.5.21.8 | Web Part Info Result Set | 295 |
| 3.1.5.21.9 | Zone ID Result Set | 295 |
| 3.1.5.21.10 | File Format Metadata Result Set | 295 |
| 3.1.5.21.11 | List Metadata Result Set | 296 |
| 3.1.5.21.12 | Empty List Result Set | 296 |
| 3.1.5.21.13 | Event Receivers Result Set (1) | 296 |
| 3.1.5.21.14 | Document Information and Content (Update) Metadata Result Set | 296 |
| 3.1.5.21.15 | Document Information and Content (Update) Stream Result Set | 297 |
| 3.1.5.21.16 | Document Version Information and Content (Update) Metadata Result Set | 297 |
| 3.1.5.21.17 | Document Version Information and Content (Update) Stream Result Set | 297 |
| 3.1.5.21.18 | Attachment State Result Set | 297 |
| 3.1.5.22 | proc_FetchWelcomeNames | 298 |
| 3.1.5.22.1 | Welcome Pages Result Set | 298 |
| 3.1.5.23 | proc_GenerateNextId | 298 |
| 3.1.5.24 | proc_GetAllRolesForUser | 299 |
| 3.1.5.24.1 | User Roles Result Set | 299 |
| 3.1.5.25 | proc_GetAuditMask | 300 |
| 3.1.5.25.1 | Audit Mask Result Set | 300 |
| 3.1.5.26 | proc_GetAuditMaskOutput | 300 |
| 3.1.5.27 | proc_GetContainingList | 301 |
| 3.1.5.27.1 | List Metadata Result Set | 302 |
| 3.1.5.27.2 | Empty Result Set | 302 |
| 3.1.5.27.3 | Event Receivers Result Set | 302 |
| 3.1.5.28 | proc_GetContainingListCore | 302 |
| 3.1.5.28.1 | List Metadata Result Set | 304 |
| 3.1.5.28.2 | Empty Result Set | 304 |
| 3.1.5.29 | proc_GetDocsMetaInfo | 304 |
| 3.1.5.29.1 | Individual URL Security Result Set | 306 |
| 3.1.5.29.2 | NULL Individual Url Security Result Set | 306 |
| 3.1.5.29.3 | Server Time Result Set | 307 |
| 3.1.5.29.4 | Subsite List Result Set | 307 |
| 3.1.5.29.5 | Link Info Result Set | 307 |
| 3.1.5.29.6 | Multiple Document Metadata Result Set | 307 |
| 3.1.5.30 | proc_GetLinkInfoSingleDoc | 312 |
| 3.1.5.30.1 | Link Info Single Doc Result Set | 312 |
| 3.1.5.31 | proc_GetListCheckedOutFiles | 312 |
| 3.1.5.31.1 | Checked Out Files Result Set | 313 |
| 3.1.5.32 | proc_GetListFields | 313 |
| 3.1.5.32.1 | Fields Information Result Set | 314 |
| 3.1.5.33 | proc_GetListMetaAndEventReceivers | 314 |
| 3.1.5.33.1 | List Metadata Result Set | 315 |
| 3.1.5.33.2 | Unique Permissions Result Set | 315 |
| 3.1.5.33.3 | NULL Unique Permissions Result Set | 315 |
| 3.1.5.33.4 | List Event Receivers Result Set | 316 |
| 3.1.5.33.5 | List Web Parts Result Set | 316 |
| 3.1.5.33.6 | List Related Fields Result Set | 316 |

| | | |
|-------------|--|-----|
| 3.1.5.34 | proc_getObject | 316 |
| 3.1.5.34.1 | Object Result Set | 317 |
| 3.1.5.35 | proc_getObjectsByBaseClass | 317 |
| 3.1.5.35.1 | Object ID Result Set | 318 |
| 3.1.5.36 | proc_getObjectsByClass | 318 |
| 3.1.5.36.1 | Object ID Result Set | 318 |
| 3.1.5.37 | proc_GetSiteFlags | 319 |
| 3.1.5.37.1 | Site Collection Flags Result Set | 319 |
| 3.1.5.38 | proc_getSiteMap | 319 |
| 3.1.5.38.1 | Site Map Result Set | 320 |
| 3.1.5.39 | proc_getSiteMapById | 320 |
| 3.1.5.39.1 | Site Map By Id Result Set | 321 |
| 3.1.5.40 | proc_GetTpWebMetaDataAndListMetaData | 322 |
| 3.1.5.40.1 | Web Url Result Set | 325 |
| 3.1.5.40.2 | Domain Group Cache Versions Result Set | 325 |
| 3.1.5.40.3 | Domain Group Cache BEDS Update Result Set | 325 |
| 3.1.5.40.4 | Domain Group Cache WFE Update Result Set | 326 |
| 3.1.5.40.5 | Site Metadata Result Set | 326 |
| 3.1.5.40.6 | Site Collection Event Receivers Result Set | 326 |
| 3.1.5.40.7 | Site Event Receivers Result Set | 326 |
| 3.1.5.40.8 | Site MetaInfo Result Set | 327 |
| 3.1.5.40.9 | Site Feature List Result Set | 327 |
| 3.1.5.40.10 | Site Unique Permissions Result Set | 327 |
| 3.1.5.40.11 | Site NULL Unique Permissions Result Set | 327 |
| 3.1.5.40.12 | Empty Result Set | 328 |
| 3.1.5.40.13 | Redirect Url Result Set | 328 |
| 3.1.5.40.14 | No Welcome Redirect Url Result Set | 329 |
| 3.1.5.40.15 | List Identifier Result Set | 329 |
| 3.1.5.40.16 | List Metadata Result Set | 330 |
| 3.1.5.40.17 | List Related Fields Result Set | 330 |
| 3.1.5.40.18 | List Unique Permissions Result Set | 330 |
| 3.1.5.40.19 | List NULL Unique Permissions Result Set | 330 |
| 3.1.5.40.20 | Event Receivers Result Set | 330 |
| 3.1.5.40.21 | List Web Parts Result Set | 331 |
| 3.1.5.40.22 | List Metadata Result Set (1) | 331 |
| 3.1.5.40.23 | Unique Permissions Result Set | 331 |
| 3.1.5.40.24 | NULL Unique Permissions Result Set | 332 |
| 3.1.5.40.25 | Event Receivers Result Set (1) | 332 |
| 3.1.5.40.26 | List Web Parts Result Set (1) | 333 |
| 3.1.5.40.27 | Document Metadata Result Set | 333 |
| 3.1.5.40.28 | NULL Result Set | 333 |
| 3.1.5.40.29 | App Principal Information Result Set | 333 |
| 3.1.5.40.30 | App Principal Permissions Result Set | 334 |
| 3.1.5.41 | proc_GetUniqueScopesInList | 334 |
| 3.1.5.41.1 | Unique Permissions Result Set | 334 |
| 3.1.5.41.2 | NULL Unique Permissions Result Set | 335 |
| 3.1.5.42 | proc_GetVersion | 335 |
| 3.1.5.43 | proc_GetWebMetaInfo | 336 |
| 3.1.5.43.1 | Site MetaInfo Result Set | 337 |
| 3.1.5.43.2 | Domain Group Cache Versions Result Set | 337 |
| 3.1.5.43.3 | Domain Group Cache BEDS Update Result Set | 337 |
| 3.1.5.43.4 | Domain Group Cache WFE Update Result Set | 338 |
| 3.1.5.43.5 | Site Metadata Result Set | 338 |

| | | |
|------------|---|-----|
| 3.1.5.43.6 | Event Receivers Result Set | 338 |
| 3.1.5.44 | proc_GetWebMetainfoByUrl | 338 |
| 3.1.5.44.1 | Site URL Result Set..... | 339 |
| 3.1.5.44.2 | Site Metainfo Result Set | 339 |
| 3.1.5.44.3 | Domain Group Cache Versions Result Set | 340 |
| 3.1.5.44.4 | Domain Group Cache BEDS Update Result Set | 340 |
| 3.1.5.44.5 | Domain Group Cache WFE Update Result Set..... | 340 |
| 3.1.5.44.6 | Site Metadata Result Set | 340 |
| 3.1.5.44.7 | Event Receivers Result Set | 341 |
| 3.1.5.45 | proc_ListDocumentVersions | 341 |
| 3.1.5.45.1 | Individual URL Security Result Set..... | 342 |
| 3.1.5.45.2 | NULL Individual URL Security Result Set..... | 342 |
| 3.1.5.45.3 | Document Versions Result Set | 342 |
| 3.1.5.46 | proc_ListRbsStores | 343 |
| 3.1.5.46.1 | List RBS Stores Result Set | 343 |
| 3.1.5.47 | proc_ListUrls | 343 |
| 3.1.5.47.1 | Individual URL Security Result Set..... | 345 |
| 3.1.5.47.2 | NULL Individual URL Security Result Set..... | 345 |
| 3.1.5.47.3 | Server Time Result Set | 345 |
| 3.1.5.47.4 | Subsite List Result Set | 345 |
| 3.1.5.47.5 | Document Metadata Result Set | 346 |
| 3.1.5.47.6 | Link Info Result Set | 350 |
| 3.1.5.47.7 | Contained Document Metadata Result Set | 350 |
| 3.1.5.48 | proc_RenameUrl | 354 |
| 3.1.5.48.1 | Rename Result Set | 357 |
| 3.1.5.48.2 | Backward Link Result Set | 357 |
| 3.1.5.49 | proc_SecAddPrincipalToRole..... | 358 |
| 3.1.5.49.1 | Site Audit Mask Result Set..... | 359 |
| 3.1.5.50 | proc_SecAddRoleDef | 359 |
| 3.1.5.50.1 | Site Audit Mask Result Set..... | 360 |
| 3.1.5.51 | proc_SecAddUser..... | 360 |
| 3.1.5.52 | proc_SecAddUserToSiteGroup | 363 |
| 3.1.5.53 | proc_SecAddWebMembership..... | 364 |
| 3.1.5.54 | proc_SecChangeToInheritedList..... | 365 |
| 3.1.5.54.1 | Site Audit Mask Result Set..... | 365 |
| 3.1.5.55 | proc_SecChangeToInheritedWeb..... | 365 |
| 3.1.5.55.1 | Inherited Site Result Set | 366 |
| 3.1.5.55.2 | Site Audit Mask Result Set..... | 366 |
| 3.1.5.56 | proc_SecChangeToUniqueScope | 366 |
| 3.1.5.56.1 | Site Audit Mask Result Set..... | 368 |
| 3.1.5.57 | proc_SecCheckDeletedAccounts..... | 368 |
| 3.1.5.57.1 | Login Result Set | 369 |
| 3.1.5.58 | proc_SecCloneRoleDefinitions..... | 369 |
| 3.1.5.58.1 | Site Audit Mask Result Set..... | 370 |
| 3.1.5.59 | proc_SecCreateSiteGroup | 370 |
| 3.1.5.60 | proc_SecDecCurrentUsersCount..... | 372 |
| 3.1.5.61 | proc_SecGetAccountStatus | 372 |
| 3.1.5.61.1 | Account Status Result Set | 373 |
| 3.1.5.62 | proc_SecGetAclFromScope..... | 373 |
| 3.1.5.62.1 | ACL and Permission Result Set..... | 373 |
| 3.1.5.63 | proc_SecGetAllAclsForSite..... | 374 |
| 3.1.5.63.1 | Access Control List Result Set | 374 |
| 3.1.5.64 | proc_SecGetAllGroupsAndMembershipInfo | 374 |

| | | |
|------------|---|-----|
| 3.1.5.64.1 | Groups Result Set..... | 375 |
| 3.1.5.64.2 | Group Membership Result Set | 375 |
| 3.1.5.65 | proc_SecGetApplicationPrincipalAndUserToken | 376 |
| 3.1.5.65.1 | Application Principal Result Set | 377 |
| 3.1.5.65.2 | External Token Result Set..... | 377 |
| 3.1.5.66 | proc_SecGetCompleteWebRoleMemberList..... | 377 |
| 3.1.5.66.1 | Role Member Result Set | 378 |
| 3.1.5.67 | proc_SecGetCurrentUsersCount..... | 378 |
| 3.1.5.67.1 | User Count Result Set..... | 379 |
| 3.1.5.68 | proc_SecGetDomainGroupMapData | 379 |
| 3.1.5.68.1 | Domain Group Cache Versions Result Set | 380 |
| 3.1.5.68.2 | Domain Group Cache BEDS Update Result Set | 380 |
| 3.1.5.68.3 | Domain Group Cache WFE Update Result Set..... | 380 |
| 3.1.5.69 | proc_SecGetGroupById | 380 |
| 3.1.5.70 | proc_SecGetGroupOwner | 381 |
| 3.1.5.71 | proc_SecGetGroupSecurityScopes..... | 381 |
| 3.1.5.71.1 | Security Scopes Result Set | 382 |
| 3.1.5.72 | proc_SecGetIndividualUrlSecurityCheckEventReceivers..... | 382 |
| 3.1.5.72.1 | Individual URL Security Result Set..... | 383 |
| 3.1.5.72.2 | NULL Individual URL Security Result Set..... | 383 |
| 3.1.5.72.3 | List Metadata Result Set..... | 384 |
| 3.1.5.72.4 | Event Receivers Result Set | 384 |
| 3.1.5.72.5 | List Scopes Result Set..... | 384 |
| 3.1.5.73 | proc_SecGetItemsWithUniquePermissions | 384 |
| 3.1.5.73.1 | Items with Unique Permissions Result Set | 385 |
| 3.1.5.74 | proc_SecGetPrincipalByEmail..... | 386 |
| 3.1.5.74.1 | Principal User Information Result Set | 386 |
| 3.1.5.75 | proc_SecGetPrincipalById | 386 |
| 3.1.5.75.1 | User Information Result Set..... | 387 |
| 3.1.5.76 | proc_SecGetPrincipalByIdEx | 388 |
| 3.1.5.76.1 | Extended Principal User Information Result Set | 389 |
| 3.1.5.77 | proc_SecGetPrincipalByLogin..... | 390 |
| 3.1.5.77.1 | User Information Result Set..... | 390 |
| 3.1.5.78 | proc_SecGetPrincipalByLogin20 | 391 |
| 3.1.5.78.1 | User Information Result Set..... | 392 |
| 3.1.5.79 | proc_SecGetPrincipalDisplayInformation20..... | 392 |
| 3.1.5.79.1 | Site Group Principal Display Information Result Set | 393 |
| 3.1.5.79.2 | Security Principal Display Information Result Set..... | 394 |
| 3.1.5.80 | proc_SecGetRoleAssignments..... | 395 |
| 3.1.5.80.1 | WSSACE Result Set | 395 |
| 3.1.5.81 | proc_SecGetRoleBindingsForAllPrincipals | 396 |
| 3.1.5.81.1 | Role Assignment Result Set | 396 |
| 3.1.5.82 | proc_SecGetRoleDefs | 396 |
| 3.1.5.82.1 | Role Definition Result Set | 397 |
| 3.1.5.83 | proc_SecGetSecurityInfo | 397 |
| 3.1.5.83.1 | Security Information Result Set..... | 398 |
| 3.1.5.84 | proc_SecGetSiteAdmins..... | 399 |
| 3.1.5.84.1 | Site Administrators Result Set..... | 399 |
| 3.1.5.85 | proc_SecGetSiteGroupById | 400 |
| 3.1.5.85.1 | Site Group Result Set..... | 400 |
| 3.1.5.86 | proc_SecGetSiteGroupByTitle | 400 |
| 3.1.5.86.1 | Site Group Information Result Set | 401 |
| 3.1.5.87 | proc_SecGetSiteGroupByTitle20 | 401 |

| | | |
|-------------|---|-----|
| 3.1.5.87.1 | Site Group Information Result Set | 402 |
| 3.1.5.88 | proc_SecGetUserAccountDirectoryPath | 402 |
| 3.1.5.88.1 | User Account Directory Path Result Set | 402 |
| 3.1.5.89 | proc_SecGetUserPermissionOnGroup | 402 |
| 3.1.5.90 | proc_SecGetWebsAndListWithUniquePermissions | 403 |
| 3.1.5.90.1 | Site Information Result Set | 404 |
| 3.1.5.90.2 | Sub Site Information Result Set | 404 |
| 3.1.5.90.3 | Site List Information Result Set | 405 |
| 3.1.5.90.4 | Sub Site List Information Result Set | 405 |
| 3.1.5.91 | proc_SecListAllSiteMembers | 406 |
| 3.1.5.91.1 | User Information Result Set | 406 |
| 3.1.5.92 | proc_SecListAllWebMembers | 407 |
| 3.1.5.92.1 | Site Membership Result Set | 407 |
| 3.1.5.93 | proc_SecListGroupsInRole | 408 |
| 3.1.5.93.1 | Site Group Information Result Set | 408 |
| 3.1.5.94 | proc_SecListScopeGroups | 408 |
| 3.1.5.94.1 | Site Groups Result Set | 409 |
| 3.1.5.95 | proc_SecListScopeUsers | 409 |
| 3.1.5.95.1 | User Information Result Set | 409 |
| 3.1.5.96 | proc_SecListSiteGroupMembership | 410 |
| 3.1.5.96.1 | User Information Result Set | 410 |
| 3.1.5.97 | proc_SecListSiteGroups | 411 |
| 3.1.5.97.1 | Site Group Information Result Set | 411 |
| 3.1.5.98 | proc_SecListSiteGroupsContainingUser | 411 |
| 3.1.5.98.1 | Site Group Information Result Set | 412 |
| 3.1.5.99 | proc_SecListSiteGroupsWhichUserOwns | 412 |
| 3.1.5.99.1 | Site Group Information Result Set | 412 |
| 3.1.5.100 | proc_SecListUsersInRole | 412 |
| 3.1.5.100.1 | User Role Membership Result Set | 413 |
| 3.1.5.101 | proc_SecMigrateUser | 413 |
| 3.1.5.102 | proc_SecReCalculateWebFGP | 414 |
| 3.1.5.103 | proc_SecRefreshToken | 415 |
| 3.1.5.104 | proc_SecRemoveGroup | 416 |
| 3.1.5.104.1 | DALias Result Set | 417 |
| 3.1.5.105 | proc_SecMarkGroupForWebDelete | 417 |
| 3.1.5.105.1 | DALias Result Set | 418 |
| 3.1.5.106 | proc_SecRemovePrincipalFromScope | 418 |
| 3.1.5.106.1 | Site Audit Mask Result Set | 419 |
| 3.1.5.107 | proc_SecRemoveRoleDef | 420 |
| 3.1.5.107.1 | Site Audit Mask Result Set | 420 |
| 3.1.5.108 | proc_SecRemoveUserFromScopeByLogin | 420 |
| 3.1.5.108.1 | Site Audit Mask Result Set | 421 |
| 3.1.5.109 | proc_SecRemoveUserFromSite | 421 |
| 3.1.5.110 | proc_SecRemoveUserFromSiteGroup | 422 |
| 3.1.5.111 | proc_SecRemoveUserFromSiteGroupByLogin | 423 |
| 3.1.5.112 | proc_SecResetItemPerm | 425 |
| 3.1.5.112.1 | Site Audit Mask Result Set | 425 |
| 3.1.5.113 | proc_SecResetWebToDefaultRoleDefinition | 426 |
| 3.1.5.113.1 | Site Audit Mask Result Set | 427 |
| 3.1.5.114 | proc_SecResolvePrincipal | 427 |
| 3.1.5.114.1 | Principal Information Result Set | 429 |
| 3.1.5.115 | proc_SecSetSiteGroupProperties | 429 |
| 3.1.5.116 | proc_SecSetUserAccountDirectoryPath | 431 |

| | | |
|-------------|---|------------|
| 3.1.5.117 | proc_SecSetWebRequestAccess | 432 |
| 3.1.5.118 | proc_SecUpdateAnonymousPermMask | 432 |
| 3.1.5.119 | proc_SecUpdateDomainGroupMapData | 433 |
| 3.1.5.120 | proc_SecUpdateRoleDef | 434 |
| 3.1.5.120.1 | Site Audit Mask Result Set | 435 |
| 3.1.5.121 | proc_SecUpdateUser | 435 |
| 3.1.5.122 | proc_SecUpdateUserActiveStatus | 436 |
| 3.1.5.123 | proc_TakeOverCheckOut | 436 |
| 3.1.5.124 | proc_UncheckoutDocument | 437 |
| 3.1.5.124.1 | Link Info Result Set | 438 |
| 3.1.5.124.2 | Document Metadata Result Set | 439 |
| 3.1.5.124.3 | NULL Result Set | 439 |
| 3.1.5.124.4 | Event Receivers Result Set | 439 |
| 3.1.5.125 | proc_UpdateDocBuildDependencySet | 439 |
| 3.1.5.126 | proc_UpdateDocument | 440 |
| 3.1.5.126.1 | Site List For Normalization Result Set | 445 |
| 3.1.5.126.2 | Site Audit Mask Result Set | 446 |
| 3.1.5.126.3 | Lock Information Result Set | 446 |
| 3.1.5.127 | proc_UpdateListItem | 446 |
| 3.1.5.127.1 | Item Update Result Set | 451 |
| 3.1.5.128 | proc_UpdateListSettings | 452 |
| 3.1.5.129 | proc_UpdateUserInfoInTableFromRowUpdater | 457 |
| 3.1.5.130 | proc_UrlToWebUrl | 458 |
| 3.1.5.130.1 | Web URL Result Set | 459 |
| 3.1.5.131 | proc_WriteChunkToAllDocStreams | 459 |
| 3.1.5.132 | proc_WriteStreamToRBS | 464 |
| 3.1.5.133 | proc_WriteStreams | 465 |
| 3.1.5.134 | proc_WriteStreamToSQL | 466 |
| 3.1.5.135 | proc_SetStreamsToDoc | 468 |
| 3.1.5.136 | proc_SetStreamsToDocNoTVP | 469 |
| 3.1.5.137 | TVF_Docs_Url_Level | 471 |
| 3.1.5.138 | TVF_UserData_ListItemLevelRow | 471 |
| 3.1.5.139 | TVF_UserData_PId_DId_Level_Row | 472 |
| 3.1.5.140 | proc_HasCurrentPublishVersion | 473 |
| 3.1.5.141 | proc_GetSiteDenyPermMask | 473 |
| 3.1.5.141.1 | Deny Permissions Mask Result Set | 474 |
| 3.1.5.142 | proc_GetNewListItemId | 474 |
| 3.1.5.143 | proc_UpdateDiskUsed | 474 |
| 3.1.6 | Timer Events | 475 |
| 3.1.7 | Other Local Events | 475 |
| 3.2 | Web Front End Client Details | 475 |
| 3.2.1 | Abstract Data Model | 475 |
| 3.2.2 | Timers | 476 |
| 3.2.3 | Initialization | 476 |
| 3.2.4 | Higher-Layer Triggered Events | 476 |
| 3.2.5 | Message Processing Events and Sequencing Rules | 476 |
| 3.2.6 | Timer Events | 476 |
| 3.2.7 | Other Local Events | 476 |
| 4 | Protocol Examples | 477 |
| 4.1 | File: Open File OM | 477 |
| 4.1.1 | Determine a User's Permission Level to a Document | 478 |
| 4.2 | Group Add User to Site Group OM | 479 |

| | | |
|----------|--|------------|
| 4.3 | Group Update Site Group Properties OM | 481 |
| 4.4 | Security: Add User to Document Library via Object Model..... | 483 |
| 4.5 | Security: Break Web Inheritance OM | 485 |
| 4.6 | Site Collection Lookup | 486 |
| 4.6.1 | Retrieving the Farm Id | 486 |
| 4.6.2 | Retrieving the Alternate URL Collection Ids..... | 487 |
| 4.6.3 | Retrieving the Alternate URL Collections..... | 487 |
| 4.6.4 | Alternate URL Matching | 488 |
| 4.6.5 | Retrieving the Web Service Ids | 488 |
| 4.6.6 | Retrieving the Web Application Ids | 488 |
| 4.6.7 | Retrieving the Web Applications | 489 |
| 4.6.8 | Web Application Lookup | 489 |
| 4.6.9 | Prefix Matching | 489 |
| 4.6.9.1 | Explicit Prefixes | 489 |
| 4.6.9.2 | Wildcard Prefixes | 490 |
| 4.6.10 | Site Collection Id Lookup | 490 |
| 4.6.11 | Building Content Database Connection String..... | 491 |
| 4.6.11.1 | Name | 491 |
| 4.7 | User Update User Properties OM | 492 |
| 4.8 | Version Negotiation..... | 495 |
| 4.9 | Folder: Move Folder OM..... | 495 |
| 5 | Security..... | 497 |
| 5.1 | Security Considerations for Implementers..... | 497 |
| 5.2 | Index of Security Parameters | 497 |
| 6 | Appendix A: Product Behavior..... | 500 |
| 7 | Change Tracking..... | 501 |
| 8 | Index | 505 |

1 Introduction

The File Operations Database Communications Version 3 Protocol specifies the communication sequences used by front-end Web servers to perform data query and update commands on back-end database servers as part of file, user, and **group (2)** administration operations.

Sections 1.8, 2, and 3 of this specification are normative and can contain the terms MAY, SHOULD, MUST, MUST NOT, and SHOULD NOT as defined in [\[RFC2119\]](#). Sections 1.5 and 1.9 are also normative but does not contain those terms. All other sections and examples in this specification are informative.

1.1 Glossary

The following terms are defined in [\[MS-GLOS\]](#):

- access control list (ACL)**
- Active Directory**
- anonymous user**
- Augmented Backus-Naur Form (ABNF)**
- code page**
- Coordinated Universal Time (UTC)**
- GUID**
- Hypertext Transfer Protocol (HTTP)**
- Hypertext Transfer Protocol over Secure Sockets Layer (HTTPS)**
- language code identifier (LCID)**
- NULL GUID**
- principal**
- Secure Sockets Layer (SSL)**
- security identifier (SID)**
- security policy**
- SOAP**
- UTF-8**
- XML**
- XML namespace**

The following terms are defined in [\[MS-OFCGLOS\]](#):

- Active Directory account creation mode**
- alert**
- app**
- app principal**
- app site domain identifier**
- app web domain identifier**
- ASP.NET**
- assembly name**
- attachment**
- audit entry**
- author**
- back-end database server**
- backward link**
- binary large object (BLOB)**
- blog**
- Boolean**
- bot**
- build dependency set**

calculated column
CAML
cascading style sheet (CSS)
Central Administration site
change log
character set
check in
check out
checked out
class identifier (CLSID)
CLSID
collation order
content database
content type
content type identifier
crawler
current user
current version
custom action
customized
datasheet
datetime
default view
directory name
dirty
discussion board
display name
displayed version
distribution list
document
document flag
document identifier
document library
document stream
document template
document version
domain group
draft
editor
email address
email enabled list
event
event host
event receiver
event sink
expire
external security provider
feature
feature identifier
field
field definition
field identifier
file
file extension
folder

form
forward link
front-end web server
full URL
fully qualified class name
group
hash
home page
host header
host name
HTTP GET
HTTP HEAD
Hypertext Markup Language (HTML)
Input Method Editor (IME)
internal version number
item
item identifier
leaf name
level
list
list identifier
list item
list item identifier
list server template
list template
list template identifier
list view
locale
locked
login name
major version
manifest
master page
meeting instance
Meeting Workspace site
member
metadict
minor version
mobile device
moderation status
navigation node
navigation node element identifier
navigation structure
owner
page
parent site
path segment
permission
permission level
personal view
provisioned
published
published version
publishing level
read-only mode

Really Simple Syndication (RSS)
Recycle Bin
request identifier
result set
return code
rich text
role
role assignment
role definition
role identifier
root folder
sandboxed solution
scope identifier
securable object
security group
security principal
security provider
security role
security scope
server-relative URL
setup path
site
site collection
site collection administrator
site collection identifier
site definition
site identifier
site subscription identifier
site template
site-relative URL
stored procedure
store-relative form
store-relative URL
stream
stream binary piece
stream identifier
stream partition
stream schema
Structured Query Language (SQL)
subsite
SystemID
TCP/IP
thicket
thicket folder
thicket main file
thicket supporting file
Transact-Structured Query Language (T-SQL)
Transport Layer Security (TLS)
uncustomized
Uniform Resource Identifier (URI)
Uniform Resource Locator (URL)
upgrade evaluation site collection
user account directory path
user identifier
user information list

user interface (UI) version
user name
version
view
virus scanner
web application
web bot
Web Part
Web Part zone
Web Part zone identifier
website
Windows code page
Windows collation name
workflow
workflow identifier
workflow instance
XML document
XML Path Language (XPath)
XML schema definition (XSD)

The following terms are specific to this document:

app host header name: A unique name assigned to an app instance.

MAY, SHOULD, MUST, SHOULD NOT, MUST NOT: These terms (in all caps) are used as described in [\[RFC2119\]](#). All statements of optional behavior use either MAY, SHOULD, or SHOULD NOT.

1.2 References

References to Microsoft Open Specification documents do not include a publishing year because links are to the latest version of the documents, which are updated frequently. References to other documents include a publishing year when one is available.

1.2.1 Normative References

We conduct frequent surveys of the normative references to assure their continued availability. If you have any issue with finding a normative reference, please contact dochelp@microsoft.com. We will assist you in finding the relevant information.

[HTML] World Wide Web Consortium, "HTML 4.01 Specification", December 1999, <http://www.w3.org/TR/html4/>

[Iseminger] Microsoft Corporation, "SQL Server 2000 Architecture and XML/Internet Support", Volume 1 of Microsoft SQL Server 2000 Reference Library, Microsoft Press, 2001, ISBN 0-7356-1280-3, <http://www.microsoft.com/mspress/books/5001.aspx>

[MC-FPSEWM] Microsoft Corporation, "[FrontPage Server Extensions: Website Management Protocol](#)".

[MS-DTYP] Microsoft Corporation, "[Windows Data Types](#)".

[MS-FPSE] Microsoft Corporation, "[FrontPage Server Extensions Remote Protocol](#)".

[MS-TDS] Microsoft Corporation, "[Tabular Data Stream Protocol](#)".

[RFC1950] Deutsch, P., and Gailly, J-L., "ZLIB Compressed Data Format Specification version 3.3", RFC 1950, May 1996, <http://www.ietf.org/rfc/rfc1950.txt>

[RFC2119] Bradner, S., "Key words for use in RFCs to Indicate Requirement Levels", BCP 14, RFC 2119, March 1997, <http://www.rfc-editor.org/rfc/rfc2119.txt>

[RFC2518] Goland, Y., Whitehead, E., Faizi, A., et al., "HTTP Extensions for Distributed Authoring - WebDAV", RFC 2518, February 1999, <http://www.ietf.org/rfc/rfc2518.txt>

[RFC2616] Fielding, R., Gettys, J., Mogul, J., et al., "Hypertext Transfer Protocol -- HTTP/1.1", RFC 2616, June 1999, <http://www.ietf.org/rfc/rfc2616.txt>

[RFC2660] Rescorla, E., and Schiffman, A., "The Secure HyperText Transfer Protocol", RFC 2660, August 1999, <http://www.ietf.org/rfc/rfc2660.txt>

[TSQL-Ref] Microsoft Corporation, "Transact-SQL Reference", <http://msdn.microsoft.com/en-us/library/dd884419.aspx>

[XPath] Clark, J. and DeRose, S., "XML Path Language (XPath), Version 1.0", W3C Recommendation, November 1999, <http://www.w3.org/TR/xpath>

1.2.2 Informative References

[CSS3UI] Celik, T., Ed., "CSS Basic User Interface Module Level 3 (CSS3 UI)", W3C Working Draft 17, January 2012, <http://www.w3.org/TR/2012/WD-css3-ui-20120117/>

[MS-GLOS] Microsoft Corporation, "[Windows Protocols Master Glossary](#)".

[MS-OFCGLOS] Microsoft Corporation, "[Microsoft Office Master Glossary](#)".

[MS-WSSFO2] Microsoft Corporation, "[Windows SharePoint Services \(WSS\): File Operations Database Communications Version 2 Protocol](#)".

[MS-WSSO] Microsoft Corporation, "[Windows SharePoint Services Overview](#)".

1.3 Overview

This protocol specifies the communication between the **front-end Web server** and the **back-end database server** used to satisfy requests involving file access and administration of users and groups (2). This client-to-server protocol uses the Tabular Data Stream Protocol [[MS-TDS](#)] as its transport between the front-end Web server, acting as a client, and the back-end database server, acting as a server. The T-SQL language [[TSQL-Ref](#)] is used to define the queries and returned data which is transported over Tabular Data Stream.

End User Clients use remote file access protocols to communicate with the Windows SharePoint Services front-end Web servers, specifically using FrontPage Server Extensions Remote Protocol (as specified in [[MS-FPSE](#)]), **Hypertext Transfer Protocol (HTTP)** (as specified in [[RFC2616](#)]), and WebDAV (as specified in [[RFC2518](#)]).

Further information about the interoperation of the clients with the front-end Web server, and the front-end Web server with the back-end database server, can be found in the Windows SharePoint Services Technical Document [[MS-WSSO](#)].

1.3.1 File Operations

This protocol provides methods for retrieving and manipulating files' properties, along with support for retrieving and manipulating files' security information. When client requests for files or file

information are sent to the front-end Web server, the front-end Web server sends a series of **stored procedure** calls to the back-end database server for the requested information. The stored procedures return data that in turn can be used for further calls to other stored procedures. The front-end Web server turns the values in the stored procedures' **return codes** and **result sets** into the data and metadata for the files requested by the client, and sends it back to the client using the same protocol used by the initial request.

1.3.2 User and Group Operations

This protocol provides methods for retrieving and manipulating information about individual users and groups (2), along with support for retrieving information from **Active Directory** about users. When the Object Model on the front-end Web server operates on requests to query or update users or groups (2), the front-end Web server confirms whether the data is already populated in the local objects that represent the specific user or groups (2). If it does not exist, the front-end Web server sends a series of stored procedure calls to the back-end database server for the requested information. The stored procedures return data, which in turn can be used for further calls to other stored procedures. The front-end Web server turns the values in the stored procedures' return codes and result sets into objects that contain the data and metadata for the requested users or groups (2), and uses the objects according to implementation-specific procedures.

1.4 Relationship to Other Protocols

This protocol relies on [\[MS-TDS\]](#) as its transport protocol to invoke stored procedures to inspect and manipulate **document** properties via result sets and return codes. Database queries or calls to stored procedures, and the returned result sets, are written in the [\[TSQL-Ref\]](#) language.

The relationship between Tabular Data Stream Protocol (TDS), SNMP Multiplexing (SMUX), **Transport Layer Security (TLS)** and **Secure Sockets Layer (SSL)**, and Transmission Control Protocol/Internet Protocol (**TCP/IP**) is illustrated in the following figure.

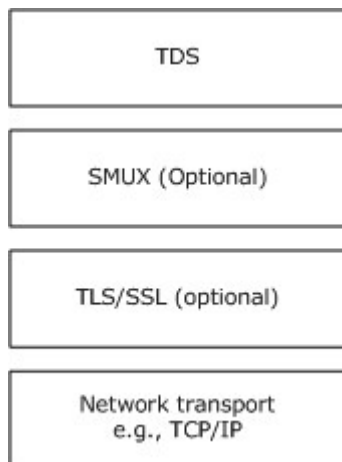

Figure 1: Protocol relationship

Requests to a front-end Web server via FrontPage Server Extensions (as specified in [\[MS-FPSE\]](#)) and WebDAV (as specified in [\[RFC2518\]](#)) rely on this protocol, via the front-end Web server, to retrieve and manipulate file and security information persistently stored on the back-end database server and to service requests for files and their properties from their clients.

1.5 Prerequisites/Preconditions

Unless otherwise specified, the stored procedures and any related tables are present in the **content database** that is being queried on the back-end database server. The tables in the content database have to contain valid data in a consistent state to be queried successfully by the stored procedures.

For operations defined in this document, any file access, addition, or modification has to be to a valid location, such as a **site, list, document library, folder**, or document, as defined by the data within the tables and the front-end Web server, in order for the request to be successfully processed. The user making the request to the front-end Web server has to have adequate **permission** to access the content of the specified valid location in order for the request to be successfully processed.

1.6 Applicability Statement

This protocol is only applicable to front-end Web servers when communicating with the back-end database server for file, user, and group (2) administration operations.

1.7 Versioning and Capability Negotiation

The front-end Web server and back-end database server use this protocol to perform explicit version verifications. The front-end Web server calls stored procedure **proc_GetVersion** to retrieve version information from the back-end database server, which it uses to decide whether it needs to connect with the back-end database server. The version information is stored in the Versions table (section [2.2.6.12](#)).

1.8 Vendor-Extensible Fields

For complex types defined in this document, an implementation of protocol servers can optionally support reading, writing, and persisting additional arbitrary elements or attributes. Unless otherwise specified in the underlying schema definition, this capability MUST NOT be used by vendors or by protocol server implementations to provide extensions to the schema specified in this document.

The **Customization** element, which is specified in the **FieldDefinition** type (section [2.2.7.3.3](#)), can be used by third parties to store additional data on a **field (2)**.

1.9 Standards Assignments

None.

2 Messages

2.1 Transport

[\[MS-TDS\]](#) is the transport protocol used to call the stored procedures, query **SQL** Views, or SQL Tables, and return Result Codes and result sets.

2.2 Common Data Types

The following are common data types used in conjunction with this protocol. The low-level data type and size are specified using commonly-known data type descriptions. It is possible that the variable is stored in multiple T-SQL data types, depending on the actual implementation of each Stored Procedure, Result Set, or Database Table.

2.2.1 Simple Data Types and Enumerations

2.2.1.1 Simple Data Types

2.2.1.1.1 Content Type Identifier

A content type identifier is a numeric string value of arbitrary but limited length, which uniquely identifies a **content type**, stored on the back-end database server (BEDS) as a T-SQL varbinary(512).

2.2.1.1.2 Document Identifier

A **document identifier (2)** is a **GUID**, as specified in [\[MS-DTYP\]](#) section 2.3.2.3, used to uniquely identify a document within a **site collection**. Specialized varieties of document identifiers (2) include **site identifiers** and **list identifiers**.

2.2.1.1.3 Event Receiver Identifier

An event receiver identifier is a GUID used to uniquely identify an **event receiver** within a site collection.

2.2.1.1.4 Feature Identifier

A feature identifier is a GUID used to uniquely identify a **feature** within a site collection.

2.2.1.1.5 List Identifier

A list identifier is a variety of document identifier (2). The list identifier is a GUID used to uniquely identify a list within a site collection.

2.2.1.1.6 List Item Identifier

A list item identifier is a 4-byte integer value used to uniquely identify a **list item** within any list in a particular site collection.

2.2.1.1.7 Role Identifier

A **Role Identifier** is a 4-byte integer value used to uniquely identify a Role Definition within a site collection.

| Role identifier value | Role definition |
|-----------------------|-----------------|
| 1073741825 | Guest |
| 1073741826 | Reader |
| 1073741827 | Contributor |
| 1073741828 | Web Designer |
| 1073741829 | Administrator |

2.2.1.1.8 Scope Identifier

A **scope identifier** is a GUID used to uniquely identify a scope within a site collection.

2.2.1.1.9 Site Collection Identifier

A site collection identifier is a GUID used to uniquely identify a site collection within a content database.

2.2.1.1.10 Site Group Identifier

A site group identifier is a 4-byte integer value used to uniquely identify a site group within a site collection. Site group identifiers are assigned from the same numbering space as User Identifiers and cannot overlap. Values of -1 and 0 are reserved to indicate invalid or unknown user or site group identifiers. [<1>](#)

2.2.1.1.11 Site Identifier

A site identifier is a variety of document identifier (2). The site identifier is a GUID used to uniquely identify a site within a site collection.

2.2.1.1.12 SystemID

A **SystemID** is a binary value of arbitrary but limited length that uniquely identifies a **principal**, stored on the BEDS as a T-SQL varbinary(512).

2.2.1.1.13 User Identifier

A **user identifier** is a 4-byte integer value used to uniquely identify a principal within a site collection. User identifiers are assigned from the same numbering space as site group identifiers and cannot overlap. Certain user identifiers are predefined such as the system account (1073741823), the site collection **owner (1)**, and the secondary site collection contact (2). Values of -1 and 0 are reserved to indicate invalid or unknown user or site group identifiers.

2.2.1.1.14 View Identifier

A view identifier is a 4-byte integer value used to identify a **view** within a list or document library. A view identifier is unique only within a particular list or document library.

2.2.1.1.15 Web Part Identifier

A Web Part identifier is a GUID used to uniquely identify a **Web Part** within a site collection.

2.2.1.1.16 Workflow Identifier

A **workflow identifier** is a GUID used to uniquely identify a **workflow (2)** within a site collection.

2.2.1.1.17 tPermMask

A **tPermMask** is an 8-byte integer value used to specify the rights that can be assigned to a user or site group.

2.2.1.2 Enumerations

2.2.1.2.1 Attachments Flag

The **Attachments Flag** is a 1-byte integer flag that specifies whether an item appears to be an **attachment** or a folder related to attachments based on this document's **Uniform Resource Locator (URL)**. The following are valid values for **Attachments Flag**.

| Value | Description |
|-------|--|
| 0 | The URL does not appear to be an attachment. |
| 1 | The URL is an attachment file. The directory name of the document has the string "Attachments" as its next-to-last path segment , and a 32-bit, base-10, signed integer as the last path segment that is referring to the item ID to which this file is attached and where the permissions will be checked (for example, "Announcements/Attachments/17/file1.txt"). |
| 2 | The URL is a list item attachment folder (for example, "Announcements/Attachments/17"). |
| 3 | The URL is the list Attachments folder itself. The last path segment of the URL is the string "Attachments" (for example, "Announcements/Attachments"). |

2.2.1.2.2 Audit Item Type

Audit Item Type is a 2-byte integer flag that specifies the type of the object in an audit specification. The following are the only valid values for **Audit Item Type**.

| Value | Description |
|-------|--------------------------|
| 1 | A page or a file. |
| 3 | A list item. |
| 4 | A list. |
| 5 | A folder. |
| 6 | A site. |
| 7 | A site collection. |

2.2.1.2.3 Calendar Type

Calendar Type is a 2-byte integer value that specifies the type of calendar to use in a particular context. The only valid values of the **Calendar Type** are specified as follows.

| Value | Description |
|-------|------------------------------------|
| 1 | Gregorian (localized) |
| 3 | Japanese Emperor Era |
| 4 | Taiwan Calendar |
| 5 | Korean Tangun Era |
| 6 | Hijri (Arabic Lunar) |
| 7 | Thai |
| 8 | Hebrew (Lunar) |
| 9 | Gregorian (Middle East French) |
| 10 | Gregorian (Arabic) |
| 11 | Gregorian (Transliterated English) |
| 12 | Gregorian (Transliterated French) |
| 16 | Saka Era |
| 23 | Umm al-Qura |

2.2.1.2.4 Collation Order Enumeration

Collation Order Enumeration is a 2-byte integer value indicating **collation order** for textual information. The Collation Order values are mapped to Windows Collation Designator values, as defined in [\[Iseminger\]](#). The only valid values of **Collation Order Enumeration** are specified as follows.

| Value | Description |
|-------|-------------------------|
| 0 | Albanian |
| 1 | Arabic |
| 2 | Chinese_PRC |
| 3 | Chinese_PRC_Stroke |
| 4 | Chinese_Taiwan_Bopomofo |
| 5 | Chinese_Taiwan_Stroke |
| 6 | Croatian |
| 7 | Cyrillic_General |
| 8 | Czech |
| 9 | Danish_Norwegian |
| 10 | Estonian |

| Value | Description |
|--------------|------------------------|
| 11 | Finnish_Swedish |
| 12 | French |
| 13 | Georgian_Modern_Sort |
| 14 | German_PhoneBook |
| 15 | Greek |
| 16 | Hebrew |
| 17 | Hindi |
| 18 | Hungarian |
| 19 | Hungarian_Technical |
| 20 | Icelandic |
| 21 | Japanese |
| 22 | Japanese_Unicode |
| 23 | Korean_Wansung |
| 24 | Korean_Wansung_Unicode |
| 25 | Latin1_General |
| 26 | Latvian |
| 27 | Lithuanian |
| 28 | Lithuanian_Classic |
| 29 | Traditional_Spanish |
| 30 | Modern_Spanish |
| 31 | Polish |
| 32 | Romanian |
| 33 | Slovak |
| 34 | Slovenian |
| 35 | Thai |
| 36 | Turkish |
| 37 | Ukrainian |
| 38 | Vietnamese |
| 39 | Azeri_Cyrillic_90 |
| 40 | Azeri_Latin_90 |

| Value | Description |
|-------|-----------------------------|
| 41 | Chinese_Hong_Kong_Stroke_90 |
| 42 | Divehi_90 |
| 43 | Indic_General_90 |
| 44 | Kazakh_90 |
| 45 | Macedonian_FYROM_90 |
| 46 | Syriac_90 |
| 47 | Tatar_90 |
| 48 | Uzbek_Latin_90 |

2.2.1.2.5 Event Host Type

Event Host Type is a 4-byte, signed integer that specifies the type of object used as an **event host** for an event receiver. The only valid values of the **Event Host Type** are specified as follows.

| Value | Description |
|-------|--------------------------------------|
| -1 | The Event Host Type is invalid. |
| 0 | The event host is a site collection. |
| 1 | The event host is a site. |
| 2 | The event host is a list. |
| 3 | The event host is a list item. |
| 4 | The event host is a content type. |
| 5 | The event host is a workflow (2). |
| 6 | The event host is a feature. |

2.2.1.2.6 Event Receiver Type

Event Receiver Type is a 32-bit signed integer that specifies the type of an event receiver, which specifies when the handler for the **event (2)** is invoked. The only valid values of the **Event Receiver Type** are specified as follows.

| Value | Description |
|-------|--|
| 1 | The event receiver is invoked before a list item is added. |
| 2 | The event receiver is invoked before a list item is updated. |
| 3 | The event receiver is invoked before a list item is deleted. |
| 4 | The event receiver is invoked before a list item is checked in. |
| 5 | The event receiver is invoked before a list item is checked out. |

| Value | Description |
|--------------|---|
| 6 | The event receiver is invoked before a list item checkout is reverted. |
| 7 | The event receiver is invoked before an attachment to a list item is added. |
| 8 | The event receiver is invoked before an attachment to a list item is deleted. |
| 9 | The event receiver is invoked before a document is moved. |
| 101 | The event receiver is invoked before a field (2) is added to the schema of a list. |
| 102 | The event receiver is invoked before a field (2) is updated in the schema of a list. |
| 103 | The event receiver is invoked before a field (2) is deleted from the schema of a list. |
| 104 | The event receiver is invoked before a list is added. |
| 105 | The event receiver is invoked before a list is deleted. |
| 201 | The event receiver is invoked before a site collection is deleted. |
| 202 | The event receiver is invoked before a site is deleted. |
| 203 | The event receiver is invoked before a site is moved. |
| 204 | The event receiver is invoked before a site is added. |
| 501 | The event receiver is invoked before a workflow (2) is started. |
| 10001 | The event receiver is invoked after a list item is added. |
| 10002 | The event receiver is invoked after a list item is updated. |
| 10003 | The event receiver is invoked after a list item is deleted. |
| 10004 | The event receiver is invoked after a list item is checked in. |
| 10005 | The event receiver is invoked after a list item is checked out. |
| 10006 | The event receiver is invoked after a list item checkout is reverted. |
| 10007 | The event receiver is invoked after an attachment is added to a list item. |
| 10008 | The event receiver is invoked after an attachment is deleted from a list item. |
| 10009 | The event receiver is invoked after a document is moved. |
| 10010 | The event receiver is invoked after a document is transformed by the document transformation feature. |
| 10101 | The event receiver is invoked after a field (2) is added to the schema of a list. |
| 10102 | The event receiver is invoked after a field (2) is updated in the schema of a list. |
| 10103 | The event receiver is invoked after a field (2) is deleted from the schema of a list. |
| 10104 | The event receiver is invoked after a list is added. |
| 10105 | The event receiver is invoked after a list is deleted. |

| Value | Description |
|-------|--|
| 10201 | The event receiver is invoked after a site collection is deleted. |
| 10202 | The event receiver is invoked after a site is deleted. |
| 10203 | The event receiver is invoked after a site is moved. |
| 10204 | The event receiver is invoked after a site is provisioned . |
| 10501 | The event receiver is invoked after a workflow (2) is started. |
| 10502 | The event receiver is invoked after a workflow (2) is postponed. |
| 10503 | The event receiver is invoked after a workflow (2) is completed. |
| 20000 | The event receiver is invoked when an e-mail message is received by a list. |
| 32766 | The event receiver is context sensitive and inspects the ContextType value to perform a corresponding action. |
| 32767 | The event receiver is used as part of a workflow (2). |

2.2.1.2.7 Excluded Folder Type

Excluded Folder Type is a 4-byte integer value that indicates folders that are excluded from common listings of the subfolders in a document library because of their special **roles**. The only valid values of **Excluded Folder Type** are specified as follows.

| Value | Description |
|-------|--|
| 0 | No special handling. |
| 1 | Forms folder. This folder holds view pages within the document library or list. |
| 2 | Web images folder. This folder is named "_w" and holds image files in an image library. |
| 3 | Thumbnails folder. This folder is named "_t" and holds thumbnail images in an image library. |
| 4 | The root folder in a list or document library. |

2.2.1.2.8 LinkDynamic Type

LinkDynamic Type is a 1-byte value represented as a single, uppercase ASCII character that tracks various special link types. A **LinkDynamic** type MUST have only one value at a time. A NULL value for **LinkDynamic** is used for a **backward link**. The only valid non-NULL values of **LinkDynamic** are specified as follows.

| Value | Description |
|-------|---|
| S | The URL is "static", which is the default and requires no special handling. |
| D | The URL is "dynamic", which is a link to <Site URL>/_vti_bin/shtml.dll/DirName/LeafName. Such links are used to invoke the FrontPage SmartHTML interpreter on a file. |
| L | The URL is to a layouts page (that is, it contains a path segment with the string "_layouts"). |

| Value | Description |
|-------|---|
| H | The URL is a history link (that is, it contains a path segment with the string "_vti_history"). |
| G | A nonabsolute link from an uncustomized document that does not fall into any other category. |

2.2.1.2.9 LinkSecurity Type

A **LinkSecurity** type is a 1-byte value represented as a single, uppercase ASCII character specifying the URI scheme for a link, such as HTTP or **HTTPS**. A **LinkSecurity** type MUST have only one value at a time. A NULL value for **LinkSecurity** is used for a backward link. The only valid non-NULL values of **LinkSecurity** are specified as follows.

| Value | Description |
|-------|--|
| H | The URL begins with "http://" (a nonsecure link using the http: scheme). |
| T | The URL begins with "shhttp://" (an S-HTTP link using the Terisa's shhttp: scheme. For more details, see [RFC26601]). |
| S | The URL begins with "https://" (an SSL link using the https: or snews: scheme). |
| U | The URL is of another unknown scheme. |

2.2.1.2.10 LinkType Types

LinkType Types is a 1-byte value represented as a single, uppercase ASCII character; it specifies type information about a link. A **LinkType** type MUST have only one value at a time. A NULL value for **LinkType** is used for a backward link. The only valid non-NULL values of a **LinkType** are specified as follows.

| Value | Description |
|-------|---|
| A | The link is from the ACTION attribute of an Hypertext Markup Language (HTML) form tag. |
| B | The link is from the attribute markup of a bot . |
| C | The link is from an autogenerated table of contents. Agents can ignore the link type when determining unreferenced files within a site. |
| D | The link references programmatic content, as in the HTML OBJECT or APPLET tags. |
| E | The link is from a cascading style sheet (CSS) . |
| F | The link is from the SRC attribute of an HTML FRAME tag. |
| G | The link is to a dynamic Web template for the containing document. |
| H | The link is from an HTML HREF attribute. This can also be used as a default link type value if a more precise type does not apply. |
| I | The link is to a document that the containing document includes via an include bot. |
| J | The link is from a field (2) of this list item. |
| K | Identical to "H", except that the link contains an HTML bookmark specifier. |

| Value | Description |
|-------|--|
| L | The link is a target in an HTML image map generated from an image map bot. |
| M | The link is to an image used in an HTML image map generated from an image map bot. |
| O | The link is part of a cross-page Web Part connection. |
| P | The link is part of the markup of a Web Part within the source of the containing document. |
| Q | The link references a CSS document that provides style information for the containing document. |
| R | The link is from the MasterPageFile attribute of the @Page directive in the containing document. |
| S | The link is from an HTML SRC attribute. |
| T | The link is to the index file used by a text search bot on this page. |
| V | The link is based on the properties of the document rather than anything in the document stream . The link type is used in tracking the link between a site and the master page URL used for the site. |
| X | The link is from an XML island within an HTML document. |
| Y | The link references an HTML document whose HTML BODY tag attributes are used as a template for the attributes of the containing document's BODY tag. |
| Z | The link is part of the markup of a Web Part that exists in a Web Part zone in the containing document and is consequently not stored within the source of the containing document. |

2.2.1.2.11 List Base Type

List Base Type is a 32-bit integer enumeration of possible base types for lists. All lists are created with one of these base types, which define implementation-specific common values for list properties. The only valid values of the **List Base Type** are specified as follows.

| Value | Description |
|-------|------------------------------|
| 0 | Generic list |
| 1 | Document library |
| 3 | Discussion board list |
| 4 | Survey list |
| 5 | Issues list |

2.2.1.2.12 List Server Template

List Server Template is a 32-bit integer enumeration of the possible values for the **list server template** defining the base structure of a list. Reserved values of the **List Server Template** are specified as follows.

| Value | Description |
|-------|------------------|
| -1 | Invalid Template |

| Value | Description |
|--------------|-----------------------------------|
| 100 | Generic List Template |
| 101 | Document Library Template |
| 102 | Survey Template |
| 103 | Links Template |
| 104 | Announcements Template |
| 105 | Contacts Template |
| 106 | Events Template |
| 107 | Tasks Template |
| 108 | Discussion Template |
| 109 | Image Library Template |
| 110 | Data Sources Template |
| 111 | Web Template Catalog Template |
| 112 | User Info Catalog Template |
| 113 | Web Part Catalog Template |
| 114 | List Template Catalog Template |
| 115 | XML Form Template |
| 116 | Master Page Catalog Template |
| 117 | No Code Workflows Template |
| 118 | Workflow Process Template |
| 119 | Webpage Library Template |
| 120 | Custom Grid Template |
| 121 | Solution Catalog Template |
| 122 | No Code Workflows Public Template |
| 123 | Theme Catalog Template |
| 124 | DESIGN Catalog Template |
| 125 | APPDATA Catalog Template |
| 130 | Data Connection Library Template |
| 140 | Workflow History Template |
| 150 | Gantt Tasks Template |
| 151 | Help Library Template |

| Value | Description |
|--------------|---|
| 160 | Access Request Template |
| 171 | Tasks with Timeline and Hierarchy Template |
| 175 | Maintenance Logs Template |
| 200 | Meetings Template |
| 201 | Agenda Template |
| 202 | Meeting User Template |
| 204 | Decision (Meeting) Template |
| 207 | Meeting Objective Template |
| 210 | Textbox Template |
| 211 | Things To Bring (Meeting) Template |
| 212 | Homepage Library Template |
| 301 | Posts (Blog) Template |
| 302 | Comments (Blog) Template |
| 303 | Categories (Blog) Template |
| 402 | Facility Template |
| 403 | Whereabouts Template |
| 404 | Call Track Template |
| 405 | Circulation Template |
| 420 | Timecard Template |
| 421 | Holiday Template |
| 499 | IMEDic Template |
| 600 | External List Template |
| 700 | My Site Document Library Template |
| 1100 | Issue Tracking Template |
| 1200 | Admin Tasks |
| 1220 | Health Rules Template |
| 1221 | Health Reports Template |
| 1230 | Draft Apps Library in Developer Site Template |

2.2.1.2.13 Moderation Status

Moderation Status is a 4-byte integer indicating the moderation approval status of a list item. Configurations can require moderation approval to publish a list item or allow automatic approval. A published list item **MUST** have a **Moderation Status** of 0. The following are all possible valid values for **Moderation Status**.

| Value | Description |
|-------|---|
| 0 | The list item is approved. |
| 1 | The list item has been denied approval. |
| 2 | The list item is pending approval. |
| 3 | The list item is in the draft or checked out state. |
| 4 | The list item is scheduled for automatic approval at a future date. |

2.2.1.2.14 Page Type

Page Type is a signed 1-byte integer that is used to represent the possible page types. The reserved **Page Type** values are specified as follows.

| Value | Description |
|-------|--|
| -1 | Does not correspond to a view or a form (2) of a list. |
| 0 | The default view of the corresponding list. This view is displayed whenever this list is viewed without an explicit view being specified. |
| 1 | A view of the corresponding list, but not the default view. |
| 2 | This value is only used internally within implementation-specific code and is never stored in a database. |
| 3 | This value is only used internally within implementation-specific code and is never stored in a database. |
| 4 | A display form of a list, suitable for displaying a single list item in read-only mode . |
| 5 | This value is only used internally within implementation-specific code and is never stored in a database. |
| 6 | An edit form for a list, suitable for presenting UI to update the properties of a list item. |
| 7 | Used to represent edit forms of a list suitable for displaying in HTML file dialogs to a client application. |
| 8 | A new form for a list, suitable for presenting UI to create a new list item. |
| 9 | This value is from a previous implementation and is no longer valid. |
| 10 | This value is only used internally within implementation-specific code and is never stored in a database. |

2.2.1.2.15 Redirect Type

Redirect Type is a 1-byte value corresponding to the type of item that a URL is redirected to. The following table contains all possible values for **Redirect Type**.

| Value | Description |
|-------|---|
| 0 | Welcome page. |
| 1 | Homepage. |
| 2 | List view - redirect to root folder. |
| 3 | Provision - redirect to a template picker page during provisioning of a new list. |
| 255 | None. |

2.2.1.2.16 Role Definition Type

Role Definition Type is a 1-byte value that is used to represent the type of implementation-specific default and custom Role Definitions. This integer value **MUST** be a value enumerated in the following table.

| Value | Description |
|-------|-----------------------|
| 0 | A custom-defined role |
| 1 | Guest |
| 2 | Reader |
| 3 | Contributor |
| 4 | Web Designer |
| 5 | Administrator |

2.2.1.2.17 Virus Status

Virus Status is a 4-byte, integer enumerated type that specifies the current virus scan status of a document. The following are valid values for **Virus Status**.

| Value | Description |
|-------|---|
| 0 | This document is reported as clean from viruses. |
| 1 | This document had a virus reported by the virus scanner plug-in. |
| 2 | This document had a virus reported by the virus scanner plug-in, which the scanner determines that it can remove. |
| 3 | This document had a virus previously reported, but the virus scanner determines that it successfully removed it. |
| 4 | This document had a virus reported, and the virus scanner attempted to clean it but failed. |
| 5 | This document had a virus reported, and the scanner requested that the document be deleted. |

| Value | Description |
|-------|--|
| 6 | This document had a timeout from the virus scanner when it was last processed. |

2.2.1.2.18 App Principal Permissions Enumeration

The following table lists the values and the descriptions for the **App Principal Permissions** enumeration.

| Value | Description |
|-------|---------------------|
| 0 | No permissions. |
| 1 | Guest permissions. |
| 2 | Read permissions. |
| 3 | Write permissions. |
| 4 | Manage permissions. |
| 5 | Admin Permissions. |

2.2.2 Bit Fields and Flag Structures

2.2.2.1 Audit Flags

Audit Flags is a 4-byte unsigned integer bit mask that tracks operations to be audited on a given object. Auditing is an implementation-specific capability, which can have one or more flags set. The values of the **Audit Flags** bits are specified as follows.

| Value | Description |
|------------|---|
| 0x00000001 | Audit checkout operations. |
| 0x00000002 | Audit checkin operations. |
| 0x00000004 | Audit view operations. |
| 0x00000008 | Audit delete operations. |
| 0x00000010 | Audit update operations. |
| 0x00000020 | Audit content type update operations. |
| 0x00000040 | Audit child object deletion operations. |
| 0x00000080 | Audit List Schema change operations. |
| 0x00000100 | Audit security change operations. |
| 0x00000200 | Audit undelete operations. |
| 0x00000400 | Audit workflow (2) operations. |
| 0x00000800 | Audit copy operations. |

| Value | Description |
|------------|--------------------------|
| 0x00001000 | Audit move operations. |
| 0x00002000 | Audit search operations. |
| 0xFFFFC000 | Unused. |

2.2.2.2 Configuration Object Status

Configuration Object Status is a 4-byte unsigned integer that describes the status of the associated Configuration Object. Valid values of the **Configuration Object Status** bits are specified in the following table. The semantic meaning of each value is implementation-specific to the service that owns the Configuration Object.

| Value | Description |
|------------|---|
| 0x00000000 | The Configuration Object is provisioned and online. |
| 0x00000001 | The Configuration Object is disabled. The resources necessary to run this Configuration Object are on the machine, but the administrator needs to provision the Configuration Object and enable it. |
| 0x00000002 | The Configuration Object is offline for some unknown reason. |
| 0x00000003 | The administrator has issued the command to unprovision the Configuration Object into a disabled state, but the unprovisioning job has not completed yet. |
| 0x00000004 | The administrator has issued the command to provision the Configuration Object and turn it online, but the provisioning job has not completed yet. |
| 0x00000005 | The administrator has issued the command to upgrade the Configuration Object into an online state, but the upgrade job has not completed yet. |

2.2.2.3 Doc Flags

Doc Flags is a 4-byte unsigned integer bit mask that provides metadata about the document, which can have one or more flags set. The values of the **Doc Flags** bits are specified as follows.

| Value | Description |
|------------|--|
| 0x00000001 | This document contains dynamic content to be sent through the CAML interpreter, an implementation-specific dynamic content generation component. An example of this would be a category Web bot present in the source of the page. |
| 0x00000002 | The document is a "sub image" of another document. This is set if this document is an automatically generated thumbnail or Web image based on another item in the store. |
| 0x00000004 | The document is a type for which there was a registered parser available at the time it was saved. A parser is an implementation-specific component that can extract data and metadata from a document, which can then be used to build a list of hyperlinks and fields (2) for content types. |
| 0x00000008 | The document is a type that can contain hyperlinks. |
| 0x00000010 | The document has an associated resource in the "_private" folder that is renamed in parallel when this file is renamed. An example of this is the count file for a hit counter Web |

| Value | Description |
|------------|---|
| | bot. |
| 0x00000020 | The document is currently checked out to a user. |
| 0x00000040 | The document is customized (1) . |
| 0x00000080 | The document is, by default, a page which contains a personalized view showing the current user's personalized and customized Web Parts. |
| 0x00000100 | The document is a type that can have a document stream. |
| 0x00000200 | The document is currently checked out to a location on the user's client system. |
| 0x00000400 | The document has child documents created by the document transformations feature. |
| 0x00000800 | The document is only a namespace entry for a list item (that is, it corresponds to an item in a non-document library list that is filtered out from file system-centric enumerations). |
| 0x00001000 | Unused. |
| 0x00002000 | The document has properties in its metainfo defining a custom order of the content types. This is only valid for folders. |
| 0x00004000 | The document MUST be customized (1) when "undirtied" (that is, when dependency updates are performed for the document). This is used for documents such as a document library template, which is provisioned as uncustomized but SHOULD be customized (1) to demote content type information on the containing document library whenever that information is updated. |
| 0x00008000 | Used when a 0-byte document is saved to a document library with required check out and at least one required field (2). |
| 0x00010000 | Currently unused and MUST be ignored. |
| 0x00020000 | There is a shared lock on the document. |
| 0x00040000 | The document is the Welcome page of the site. |
| 0x00080000 | Accessing the document does not require extra permission that is normally required for documents in private list. |
| 0xFFFF0000 | Currently unused and MUST be ignored. |

2.2.2.4 Document Store Type

The **Document Store Type** is a 1-byte unsigned integer value that specifies the type of a document or the target of a link within or to a document. The only valid values for a **Document Store Type** are specified as follows.

| Value | Description |
|-------|---------------|
| 0x00 | File |
| 0x01 | Folder |
| 0x02 | Site |
| 0x80 | Backward Link |

| Value | Description |
|-------|---|
| | Backward Link can only be a return value and MUST NOT be used as an input value for a stored procedure. |

2.2.2.5 List Flags

List Flags is an 8-byte unsigned integer bit mask that provides metadata about the list, which can have one or more flags set. **List Flags** identify an implementation-specific capability. The values of the **List Flags** bits are specified as follows.

| Value | Description |
|--------------------|---|
| 0x0000000000000001 | This list is an "ordered list". |
| 0x0000000000000002 | This bit MUST be ignored. |
| 0x0000000000000004 | This list is "undeletable" (that is, it is crucial to the functioning of the containing site or site collection). |
| 0x0000000000000008 | Attachments on list items are disabled. This bit MUST be set if the list is a document library or survey. |
| 0x0000000000000010 | This list is a "catalog" (for example, a Web Part gallery or master page gallery). |
| 0x0000000000000020 | This list is associated with a site using the meetings workspace site template and contains data scoped to each instance of a recurring meeting. |
| 0x0000000000000040 | This list generates alerts (1) when a list item is assigned to a user. |
| 0x0000000000000080 | This list has versioning enabled, and supports creating historical versions of list items when changes occur. This bit MUST be ignored for Lists with a List Base Type of survey. |
| 0x0000000000000100 | This list MUST be hidden from enumeration functions. This is intended for lists implementing infrastructure for an application. |
| 0x0000000000000200 | This list is configured to bring up a page to fill out a form (2) to request access from the owner when a user is denied access while browsing its list items. |
| 0x0000000000000400 | This list has moderation enabled, requiring an approval process when content is created or modified. |
| 0x0000000000000800 | If this list is a survey, it will allow multiple responses for a given user rather than restricting users to a single response. This flag MUST be ignored for lists that do not have a List Base Type of survey. |
| 0x0000000000001000 | This list uses the value of each field's (2) ForcedDisplay attribute when presenting data from that field (2). This is commonly used in anonymous surveys to display common placeholder text wherever the respondent's name would normally appear. |
| 0x0000000000002000 | This list MUST NOT be serialized as part of saving this site as a site template. |
| 0x0000000000004000 | The List Server Template for this list can only be instantiated in the root site of a given site collection. |
| 0x0000000000008000 | When a List Server Template is being created for this list, documents in the root of the list can also be serialized. |

| Value | Description |
|--------------------|--|
| 0x0000000000010000 | Insertion of list items via email is enabled for this list. |
| 0x0000000000020000 | This is a "private" list. When a List Server Template based on this list is created, the new list can be given an ACL so that only its owner and administrators can access the list. |
| 0x0000000000040000 | This document library requires the user to check out documents before modifying them. |
| 0x0000000000080000 | This list supports creation of minor versions on item revisions. |
| 0x0000000001000000 | This document library requires that users have the EditListItems right to see minor versions of documents. |
| 0x0000000002000000 | This document library requires that users have the ApproveItems right to see minor versions of documents. |
| 0x0000000004000000 | This list supports displaying a user interface for manipulating multiple content types (for example, a list that contains both announcements and tasks). |
| 0x0000000008000000 | This list has had its schema customized from the version that exists in the on-disk schema file that was used to create it. |
| 0x0000000010000000 | Document parsers in this list generate thumbnail files corresponding to documents saved to this list. This bit MUST be ignored for lists that are not document libraries. |
| 0x0000000020000000 | Documents or list item attachments in this list can be directly browsed to by anyone who has access to the list itself. This is useful for shared resources such as the master page gallery, where one page can be used throughout a site collection in scopes with varying permissions. |
| 0x0000000040000000 | This list has workflows (2) associated with it. |
| 0x0000000080000000 | This list MUST NOT be automatically exported when exporting a list that references it. Exporting is an implementation-specific capability. |
| 0x0000000100000000 | Applications generating server transformations of list items in this list SHOULD default to open the list item in a browser rather than in a separate client-side application. Server transformations are performed by server-side document viewers that can allow clients to view documents without additional client software. Server transformations are an implementation-specific feature. |
| 0x0000000200000000 | Creation of folders is blocked in this list. |
| 0x0000000400000000 | This list disallows advanced view functionality, such as the datasheet view and views involving Web Part to Web Part connections. |
| 0x0000000800000000 | This list specifies custom sorting orders for the list of content types available on a per-folder basis. |
| 0x0000001000000000 | This list MUST NOT be exported as part of a migration package. Migration packages are an implementation-specific feature. |
| 0x0000002000000000 | This list has its schema cached in memory when possible, rather than retrieving the schema every time the list is accessed. |
| 0x0000004000000000 | This bit MUST NOT be returned by the database. |

| Value | Description |
|--------------------|---|
| 0x0000000800000000 | This list's content is not processed by a search crawler . |
| 0x0000001000000000 | Data from this list MUST be included when it is saved as a List Server Template , even if not otherwise requested. |
| 0x0000002000000000 | Content type manipulation is disabled on this list. |
| 0x0000004000000000 | RSS feed syndication is disabled for this list. |
| 0x0000008000000000 | Information Rights Management (IRM) is enabled for documents in this list. |
| 0x0000010000000000 | Expiration of IRM rights is enabled for this list. Setting this bit requires that the IRM enabled bit also be set. |
| 0x0000020000000000 | Documents that do not have a registered IRM protector will be blocked from this list. |
| 0x0000080000000000 | If this list is an events list, this list supports a user interface which allows the user to select user identities when adding new list items. |
| 0x0000100000000000 | This list has data validation criteria used to perform custom validation rules prior to the list being updated. |
| 0x0000200000000000 | If this list is an events list, this list supports a user interface for adding resources. |
| 0x0000400000000000 | The data for this list comes from an external data source. |
| 0x0000800000000000 | Calculated expressions in this list MUST preserve NULL values rather than converting them to empty strings. |
| 0x0001000000000000 | This list has list scoped custom actions . |
| 0x0002000000000000 | This site SHOULD NOT be taken offline by a client application. |
| 0x0004000000000000 | Protocol clients MUST enforce validation rules defined for this list. Validation rules are an implementation-specific capability. |
| 0x0008000000000000 | The flag for this list with value 0x0000000010000000 MUST override any server-wide settings for server transformations. Server transformations are an implementation-specific feature. |
| 0x0010000000000000 | This list is part of the infrastructure of the site that contains it and client applications SHOULD treat it as a top level navigation object when displaying information about the site that contains it. |
| 0x0020000000000000 | Views of this list SHOULD NOT display options to bulk edit data in a datasheet view. |
| 0x0040000000000000 | Protocol clients SHOULD prevent browser execution of active content from files in this library. |
| 0x0080000000000000 | The user interface for forms (2) in this list SHOULD navigate to form (2) pages instead of hosting the list form in a modal dialog. |
| 0x0100000000000000 | Calculated expressions in this list MUST return error values in the case of data type mismatch. |
| 0x0200000000000000 | This list at one time supported creation of minor versions on item revisions, so |

| Value | Description |
|--------------------|--|
| | minor versions might exist for items in this list. |
| 0xFC00000000000000 | Unused. |

2.2.2.6 Publishing Level Type

A **Publishing Level Type** is an 8-bit unsigned integer that describes the **publishing level** of a version of a document. Only the following values are valid for the **Publishing Level Type**.

| Value | Description |
|-------|---|
| 1 | The default value, referring to a published document shown to all users who have access to its storage location. |
| 2 | This document is in a draft state and is shown only to users who have permissions to see documents in a draft state. |
| 255 | This document is checked out to a particular user and shown only to that user. |

2.2.2.7 Put Flags Type

Put Flags Type is a 4-byte integer bit mask containing option flags for adding or updating a document. Zero or more of the following bit flags can be set in a **Put Flags Type**. The values of the **PutFlags** bits are specified as follows.

| Value | Description |
|------------|--|
| 0x00000001 | MUST be ignored by the back-end database server. |
| 0x00000002 | Unconditionally update the document. |
| 0x00000004 | MUST be ignored by the back-end database server. |
| 0x00000008 | Keep the document checked out. |
| 0x00000010 | MUST be ignored by the back-end database server. |
| 0x00000020 | Check the document in. |
| 0x00000040 | MUST be ignored by the back-end database server. |
| 0x00000080 | Create a thicket or thicket supporting folders. |
| 0x00000100 | MUST be ignored by the back-end database server. |
| 0x00000200 | MUST be ignored by the back-end database server. |
| 0x00000400 | MUST be ignored by the back-end database server. |
| 0x00000800 | MUST be ignored by the back-end database server. |
| 0x00001000 | Create a new user interface (UI) version of the document, even if it is in a short-term lock. |
| 0x00002000 | Set only when a document migration operation is occurring. |

| Value | Description |
|------------|---|
| 0x00004000 | MUST be ignored by the back-end database server. |
| 0x00008000 | MUST be ignored by the back-end database server. |
| 0x00010000 | Publish the document: change user interface (UI) version to published. |
| 0x00020000 | Overwrite the document without updating the displayed version of the document. |
| 0x00040000 | Unpublish document: Change user interface (UI) version from published to draft. |
| 0x00080000 | Document updated from manifest file: Add document at the default publishing level. |
| 0x00100000 | The document is being added or updated as part of a system update: Do not update the last modification time and user. |
| 0x00200000 | MUST be ignored by the back-end database server. |
| 0x00400000 | Unused. |
| 0x00800000 | Do not increment the current internal version counter value for the document. This flag can be set only if the updater can tolerate having his or her changes overwritten by another user in the event of a conflict. |
| 0x01000000 | Unused. |
| 0x02000000 | Keep the document checked out to the user's local disk. |
| 0xFC000000 | Unused. |

2.2.2.8 Rename Flags

Rename Flags is a 4-byte integer bit mask containing option flags for renaming a document. This bit mask can have zero or more flags set. The reserved values of the **RenameFlags** bits are specified as follows.

| Value | Description |
|------------|---|
| 0x00000000 | Default behavior: Rename all dependent items . |
| 0x00000001 | Do not update all related documents. <2> |
| 0x00000002 | MUST be ignored by the back-end database server. |
| 0x00000004 | Server SHOULD find backward links to update other documents linking to the original document. |
| 0x00000008 | MUST be ignored by the back-end database server. |
| 0x00000010 | MUST be ignored by the back-end database server. |
| 0x00000020 | Allow renaming of sites. |
| 0x00000040 | Set the Doc Flags (section 2.2.2.3) bit 0x00000004 to match this value when a file's extension changes. |
| 0x00000080 | Set the Doc Flags bit 0x00000008 to match this value when a file's extension changes. |

| Value | Description |
|------------|---|
| 0x00000100 | This value is only used internally within implementation-specific code. |
| 0x00000200 | Allow move into the forms (2) directory. |
| 0x00000400 | Current user can view draft versions of the source documents in a move operation. |
| 0x00000800 | Allow rename operation on a thicket main file with missing thicket supporting files . |
| 0x00001000 | MUST be ignored by the back-end database server. |
| 0x00002000 | Overwrite existing files in the destination if the source file is newer. |
| 0x00004000 | MUST be ignored by the back-end database server. |
| 0xFFFF8000 | Unused. |

2.2.2.9 Site Collection Flags

Site Collection Flags is a 4-byte, unsigned integer bit mask that specifies properties that are global to a site collection. This bit mask can have zero or more flags set. The values of the **Site Collection Flags** bits are specified as follows.

| Value | Description |
|------------|---|
| 0x00000001 | This site collection has been write-locked, and user write operations will be blocked. |
| 0x00000002 | This site collection is fully locked, and user read and write operations will be blocked. |
| 0x000003FC | Unused. |
| 0x00000400 | The site collection has sent a notification that disk usage is near its limit. |
| 0x00000800 | Unused. |
| 0x00001000 | The number of users in this site collection is large. Special consideration can be given to query execution plans when retrieving data. |
| 0x00002000 | The site collection has disabled syndication via RSS. |
| 0x00004000 | Unused. |
| 0x00008000 | Unused. |
| 0x00010000 | Unused. |
| 0x00020000 | This site collection has been write-locked by an administrative action. Users are restricted to read-only operations. |
| 0x00040000 | Unused. |
| 0x00080000 | The site collection is restricted to users with user accounts from a particular directory path within Active Directory. |
| 0x00100000 | There are sandboxed solutions activated in the site collection. |
| 0x00200000 | Email has been sent out to site collection owner about the resource usage for sandboxed solutions exceeding the resource quota warning level. |

| Value | Description |
|------------|---|
| 0x00400000 | Email has been sent out to the site collection owner about resource usage for sandboxed solutions exceeding the resource quota limit. |
| 0x00800000 | Resource usage for the sandbox solutions exceeding the resource quota limit. |
| 0x01000000 | This site collection has site collection scoped custom actions. |
| 0x02000000 | The visual Upgrade site collection UI is shown. Visual Upgrade feature allows users to choose the UI of upgraded sites. If the user chooses to update, the sites will use the new interface, which includes the ribbon; otherwise, the sites will continue to use Windows SharePoint Services 3.0 UI. |
| 0x04000000 | The visual Upgrade Site Setting UI is shown on sites in this Site Collection. Visual Upgrade feature allows users to choose the UI of upgraded sites. If the user chooses to update, the sites will use the new interface, which includes the ribbon; otherwise, the sites will continue to use Windows SharePoint Services 3.0 UI. |
| 0x08000000 | User-defined workflows (2) are disabled for this site collection. |
| 0xF0000000 | Unused. |

2.2.2.10 Site Collection Upgrade Flags

Site Collection Upgrade Flags is a 4-byte, unsigned integer bit mask that specifies properties that are global to a site collection regarding site collection upgrade. This bit mask can have zero or more flags set. The values of the **Site Collection Upgrade Flags** bits are specified as follows.

| Value | Description |
|------------|---|
| 0x00000001 | Whether site collection upgrade is allowed on this site collection is controlled by the parent of the site collection. |
| 0x00000002 | Site collection upgrade is allowed on this site collection. This bit is ignored if bit 0x00000001 is set. |
| 0x00000004 | The site collection upgrade is in progress for this site collection. |
| 0x00000008 | Whether upgrade evaluation site collection is allowed to be created is controlled at this site collection. When this bit is set, use the setting at the parent of the site collection. |
| 0x00000010 | upgrade evaluation site collection is allowed to be created. This bit is ignored if bit 0x00000008 is not set. |

2.2.2.11 Site Property Flags

Site Property Flags is a 4-byte, unsigned integer bit mask that tracks property flags applied to a site. The site can have one or more **Site Property Flags** set. These flags reference implementation-specific capabilities. The values of the **Site Property Flags** bits are specified as follows.

| Value | Description |
|------------|--|
| 0x00000001 | This site allows display of implementation-specific user presence information in the front-end Web server. |
| 0x00000002 | This site allows display of implementation-specific enhanced user presence information in |

| Value | Description |
|------------|---|
| | the front-end Web server. |
| 0x00000004 | HTML views for file dialogs MUST NOT be displayed for this site. |
| 0x00000008 | This site has disabled syndication of list items via RSS. |
| 0x00000010 | Unused. |
| 0x00000020 | The front-end Web server for this site displays the "quick launch" navigational element. |
| 0x00000040 | The front-end Web server for this site displays a hierarchical "tree view" navigational element. |
| 0x00000080 | Document parsing is disabled for this site. |
| 0x00000100 | This site has not yet been provisioned with a site template. |
| 0x00000200 | List schema information can be cached for lists within this site. |
| 0x00000400 | This site has at least one uniquely secured object within it. |
| 0x00000800 | Search indexing agents can index the rendered content from ASPX pages within this site. |
| 0x00001000 | Search indexing agents MUST NOT index the rendered content from ASPX pages within this site. |
| 0x00004000 | The site MUST be locked when performing field (2) or list operations that enable cascade deletion. |
| 0x00008000 | This allows display of implementation-specific visual upgrade or site settings information on the front-end Web server. |
| 0x00010000 | The site has at least one custom action that resides at the site level. |
| 0x00020000 | The site has at least one custom action that resides at the list level. |
| 0x00040000 | This site has been initialized since upgrade occurred. |
| 0x00080000 | This site isn't taken offline by the client. |
| 0xFFFFE000 | Unused. |

2.2.2.12 UserInfo tp_flags

A 4-byte integer bit mask determining the user's options. This can have one or more flags set. The default value is 0, but it MUST NOT be NULL. The valid flags are:

| Value | Description |
|------------|---|
| 0x00000000 | None |
| 0x00000001 | The user is associated with an external application. |
| 0x00000002 | When the user accesses the front-end Web server, the request MUST have an X-RequestToken HTTP Header, which is an opaque string value generated by the front-end Web server. |
| 0x00000004 | The user will not have permission to browse the user information list . |

2.2.2.13 View Flags

View Flags is a 4-byte, integer bit mask that corresponds to properties of a view. This bit mask can have zero or more flags set. The values of the **View Flags** bits are specified as follows.

| Value | Description |
|------------|--|
| 0x00000001 | Normal HTML-based view. |
| 0x00000002 | View has been modified by a client application such that it isn't compatible with the Web interface for view modification. Implementations MUST restrict modifying any properties they do not understand. |
| 0x00000004 | Tabular view. The view will render a check box in front of each row to use for bulk updates. |
| 0x00000008 | View MUST NOT be displayed in enumerations of the views of this List (that is, in a view selector front-end Web server element). |
| 0x00000010 | Value is unused and MUST be ignored. |
| 0x00000020 | View is read-only, and implementations MUST NOT allow any modifications to its properties. |
| 0x00000040 | If the query for this view returns no rows, implementations of the front-end Web server MUST return an HTTP 410 error when displaying this view as part of an HTTP request, instead of displaying a normal empty view body. |
| 0x00000080 | Presents data in a nontabular fashion. Implementations can format results in a manner compatible with free-form presentation. |
| 0x00000100 | View suitable for displaying in an HTML-based file navigation dialog to client applications. |
| 0x00000200 | Value is unused, and implementations MUST ignore it. |
| 0x00000400 | View has functionality for aggregating data across multiple XML documents within an XML form library. |
| 0x00000800 | View presents a datasheet view to a rich client application. |
| 0x00001000 | Displays all items in the list recursively from the specified folder, instead of only displaying the immediate children of the current folder. |
| 0x00002000 | Requires that view's data be expanded based on a calendar recurrence (for example, having a view of list item data for the first Thursday of every month). |
| 0x00004000 | View is the system-created view of a user's items awaiting moderation in a moderated list. |
| 0x00008000 | System-created moderator's view of a moderated list, which displays list items pending approval. |
| 0x00010000 | Threaded view for legacy discussion boards (lists with base type 3). Implementations MUST display results in a threaded fashion, and paging of results MUST be done in terms of threads instead of by individual list items. |
| 0x00020000 | Displays HTML-based graphical charts of list item data. |
| 0x00040000 | A personal view , which MUST only be displayed to the user who created the view. |
| 0x00080000 | Displays data on a calendar based on date and time properties of the list items. |
| 0x00100000 | Default form of the specified type for the corresponding list. |

| Value | Description |
|------------|--|
| 0x00200000 | Does not display any list items that are folders. |
| 0x00400000 | Displays list items based on the item order of the list. If this list is not an ordered list, this value MUST be 0. |
| 0x00800000 | View intended for display on mobile devices . |
| 0x01000000 | View is displayed as the default view of this list when a mobile view is requested. |
| 0x02000000 | Displays historical versions of list items. |
| 0x04000000 | Displays list item data in a Gantt chart. |
| 0x08000000 | View fetches the list item for the root folder of the view, in addition to the standard behavior of fetching all list items contained within it. |
| 0x10000000 | View is the default view presented when a view is requested for a particular content type. |
| 0x20000000 | View does not display items that have not been approved. Implementations MUST NOT show this view to anonymous users . |
| 0x40000000 | View MUST NOT be displayed to any user who does not possess the UseClientIntegration right. |
| 0x80000000 | Unused flag value, which MUST be ignored by client applications. |

2.2.2.14 Workdays Flag

Workdays Flag is a 2-byte, bit mask that is used to specify the workdays in a week for display in a calendar. The workdays are specified as the sum or bitwise OR of the bit flags specifying each day of the week. For example, if the first day of the week is a Sunday and the workdays are Monday through Friday, the combined flags value would be 0x003E, or 62. The only valid values of the **Workdays Flag** bits are specified as follows.

| Value | Description |
|---------|-----------------------------|
| 0x0001 | Saturday is a workday. |
| 0x0002 | Friday is a workday. |
| 0x0004 | Thursday is a workday. |
| 0x0008 | Wednesday is a workday. |
| 0x0010 | Tuesday is a workday. |
| 0x0020 | Monday is a workday. |
| 0x0040 | Sunday is a workday. |
| 0xFF80X | Unused and MUST NOT be set. |

2.2.2.15 WSS Rights Mask

WSS Rights Mask is an 8-byte, unsigned integer that specifies the rights that can be assigned to a user or site group. This bit mask can have zero or more flags set.

The values of the permission mask bits are specified as follows.

| Symbolic name | Value | Description |
|---------------|--------------------|------------------------|
| EmptyMask | 0x0000000000000000 | Grant no permissions. |
| FullMask | 0x7FFFFFFFFFFFFFFF | Grant all permissions. |

The list and document permissions (0x000000000000XXXX) are specified as follows.

| Symbolic name | Value | Description |
|----------------------------------|--------------------|--|
| ViewListItems | 0x0000000000000001 | Allow viewing of list items in lists, documents in document libraries, and Web discussion comments. |
| AddListItems | 0x0000000000000002 | Allow addition of list items to lists, documents to document libraries, and Web discussion comments. |
| EditListItems | 0x0000000000000004 | Allow editing of list items in lists, documents in document libraries, Web discussion comments, and to customize Web Part pages in document libraries. |
| DeleteListItems | 0x0000000000000008 | Allow deletion of list items from lists, documents from document libraries, and Web discussion comments. |
| ApproveItems | 0x0000000000000010 | Allow approval of minor versions of a list item or document. |
| OpenItems | 0x0000000000000020 | Allow viewing the source of documents with server-side file handlers. |
| ViewVersions | 0x0000000000000040 | Allow viewing of past versions of a list item or document. |
| DeleteVersions | 0x0000000000000080 | Allow deletion of past versions of a list item or document. |
| CancelCheckout | 0x0000000000000100 | Allow discard or check in of a document that is checked out to another user. |
| ManagePersonalViews | 0x0000000000000200 | Allow creation, change, and deletion of personal views of lists. |
| | 0x0000000000000400 | Reserved. |
| ManageLists | 0x0000000000000800 | Allow creation and deletion of lists, addition or removal of fields (2) to the schema of a list, and addition or removal of personal views of a list. |
| ViewFormPages | 0x0000000000001000 | Allow viewing of forms (2), views, and application pages, and enumerate lists. |
| AnonymousSearchAccessList | 0x0000000000002000 | Allow anonymous users to retrieve content of a list or document library through SharePoint search. The list permissions in the site do not |

| Symbolic name | Value | Description |
|---------------|--------------------|-------------|
| | | change. |
| | 0x000000000000D000 | Reserved. |

The Web level permissions (0x0000XXXXXXXX0000) are specified as follows.

| Symbolic name | Value | Description |
|-------------------------------|-------------------|---|
| Open | 0x000000000010000 | Allow access to the items contained within a site, list, or folder. |
| ViewPages | 0x000000000020000 | Allow viewing of pages in a site. |
| AddAndCustomizePages | 0x000000000040000 | Allow addition, modification, or deletion of HTML pages or Web Part pages, and editing of the site using a compatible editor. |
| ApplyThemeAndBorder | 0x000000000080000 | Allow application of a theme or borders to the entire site. |
| ApplyStyleSheets | 0x000000000100000 | Allow application of a style sheet (.css file) to the site. |
| ViewUsageData | 0x000000000200000 | Allow viewing of reports on site usage. |
| CreateSSCSite | 0x000000000400000 | Allow creation of a site using Self-Service Site Creation, an implementation-specific capability. |
| ManageSubwebs | 0x000000000800000 | Allow creation of a subsite within the site or site collection. |
| CreateGroups | 0x000000001000000 | Allow creation of a group (2) of users that can be used anywhere within the site collection. |
| ManagePermissions | 0x000000002000000 | Allow creation and modification of permission levels on the site and assigning permissions to users and site groups. |
| BrowseDirectories | 0x000000004000000 | Allow enumeration of documents and folders in a site using [MS-FPSE] and WebDAV interfaces. |
| BrowseUserInfo | 0x000000008000000 | Allow viewing the information about all users of the site. |
| AddDelPrivateWebParts | 0x000000001000000 | Allow addition or removal of personal Web Parts on a Web Part page. |
| UpdatePersonalWebParts | 0x000000002000000 | Allow updating of Web Parts to display personalized information. |
| ManageWeb | 0x000000004000000 | Allow all administration tasks for the site as well as manage content. |

| Symbolic name | Value | Description |
|--------------------------------------|--------------------|---|
| AnonymousSearchAccessWebLists | 0x0000000080000000 | Allow content of lists and document libraries in the site to be retrievable for anonymous users through SharePoint search if the list or document library has AnonymousSearchAccessList set. |
| | 0x00000000F0000000 | Reserved. |
| UseClientIntegration | 0x0000001000000000 | Allow use of features that launch client applications; otherwise, users can only work on documents on their local machines and upload changes to the front-end Web server. |
| UseRemoteAPIs | 0x0000002000000000 | Allow use of SOAP , WebDAV, or [MS-FPSE] to access the site. |
| ManageAlerts | 0x0000004000000000 | Allow management of alerts (1) for all users of the site. |
| CreateAlerts | 0x0000008000000000 | Allow creation of e-mail alerts (1). |
| EditMyUserInfo | 0x0000010000000000 | Allow users to change their own user information, such as adding a picture. |
| | 0x0000FE0000000000 | Reserved. |

The Special permissions (0xXXXX000000000000) are specified as follows.

| Symbolic name | Value | Description |
|-----------------------------|--------------------|---|
| | 0x3FFF000000000000 | Reserved. |
| EnumeratePermissions | 0x4000000000000000 | Allow enumeration of permissions on the site, list, folder, document, or list item. |
| | 0x8000000000000000 | Reserved. |

2.2.3 Binary Structures

2.2.3.1 Calendar View Options Type

Calendar View Options Type is a 1-byte value that specifies calendar options for front-end Web server display in the following format.

| | | | | | | | | | | | | | | | | | | | | | | | | | | | | | | | |
|-----------------|---|---|------------------|---|---|--------|--------|---|---|----|----|----|----|----|----|----|----|----|----|----|----|----|----|----|----|----|----|----|----|----|----|
| 0 | 1 | 2 | 3 | 4 | 5 | 6 | 7 | 8 | 9 | 10 | 11 | 12 | 13 | 14 | 15 | 16 | 17 | 18 | 19 | 20 | 21 | 22 | 23 | 24 | 25 | 26 | 27 | 28 | 29 | 30 | 31 |
| FirstDayOf Week | | | FirstWeek OfYear | | | WeekUI | Unused | | | | | | | | | | | | | | | | | | | | | | | | |

FirstDayOfWeek (3 bits): An unsigned integer specifying the first day of the week. The following are valid values for the **FirstDayOfWeek** value.

| Bits | Description |
|------|-------------|
| 000 | Sunday |
| 001 | Monday |
| 010 | Tuesday |
| 011 | Wednesday |
| 100 | Thursday |
| 101 | Friday |
| 110 | Saturday |

FirstWeekOfYear (2 bits): An unsigned integer specifying how the first week of the year is handled. The following are valid values for the **FirstWeekOfYear** value.

| Bits | Description |
|------|--|
| 00 | The year starts on January 1. |
| 01 | The year starts with the first complete week. |
| 10 | The year starts with the first week of at least four days. |

WeekUI (1 bit): If this bit is set, week numbers SHOULD be displayed in the front-end Web server.

Unused (2 bits): The last 2 bits of this structure are currently unused and MUST both be set to 0.

2.2.3.2 External Group Token

The **External Group Token** structure is a variable-length structure associated with a principal that contains a collection of the **systemIDs** for the external groups of which the principal is a **member (1)**.

| 0 | 1 | 2 | 3 | 4 | 5 | 6 | 7 | 8 | 9 | 10 | 11 | 12 | 13 | 14 | 15 | 16 | 17 | 18 | 19 | 20 | 21 | 22 | 23 | 24 | 25 | 26 | 27 | 28 | 29 | 30 | 31 |
|--------------------|---|---|---|---|---|---|---|---|---|----|----|----|----|----|----|----|----|----|----|----|----|----|----|----|----|----|----|----|----|----|----|
| TimeTokenGenerated | | | | | | | | | | | | | | | | | | | | | | | | | | | | | | | |
| ... | | | | | | | | | | | | | | | | | | | | | | | | | | | | | | | |
| Size | | | | | | | | | | | | | | | | | | | | | | | | | | | | | | | |
| Magic | | | | | | | | | | | | | | | | | | | | | | | | | | | | | | | |
| AuthenticationType | | | | | | | | | | | | | | | | | | | | | | | | | | | | | | | |
| UserSystemIdSize | | | | | | | | | | | | | | | | | | | | | | | | | | | | | | | |

| |
|-------------------------|
| TokenGroupsSize |
| Magic2 |
| UserSystemId (variable) |
| ... |
| TokenGroups (variable) |
| ... |

TimeTokenGenerated (8 bytes): An 8-byte, unsigned integer value specifying the time that this token was generated, stored as seconds since midnight, January 1, 1899, **Coordinated Universal Time (UTC)**.

Size (4 bytes): A 4-byte, unsigned integer value specifying the length of the External Group Token in bytes.

Magic (4 bytes): A 4-byte, unsigned integer, which MUST use the value 0xCACBCECF.

AuthenticationType (4 bytes): A 4-byte, unsigned integer value specifying the authentication provider for the **systemID** of the principal. The value MUST be one of the following.

| Value | Description |
|------------|-------------------------------------|
| 0x00000001 | Windows Integrated Authentication |
| 0x00000003 | ASP.NET Forms Authentication |

UserSystemIdSize (4 bytes): A 4-byte, unsigned integer value specifying the length of the principal's serialized binary **systemID**, in bytes.

TokenGroupsSize (4 bytes): A 4-byte, unsigned integer value specifying the length, in bytes, of the **TokenGroups** field containing the serialized binary systemIDs for the external groups.

Magic2 (4 bytes): A 4-byte, unsigned integer, which MUST use the value 0xDADBDEDF.

UserSystemId (variable): A variable-length field containing the serialized binary **systemID** for the principal, occupying the number of bytes specified in **UserSystemIdSize**.

TokenGroups (variable): A variable-length field containing a **Token Groups** structure, which contains the serialized binary **systemIDs** for the external groups of which the principal is a member (1), occupying the number of bytes specified in **TokenGroupsSize**.

2.2.3.3 Token Group Offset and Attributes

The **Token Group Offset and Attributes** structure specifies the length and offset of the serialized binary **systemID** for a corresponding external group within a **Token Groups** structure.

| | | | | | | | | | | | | | | | | | | | | | | | | | | | | | | | |
|------------|---|---|---|---|---|---|---|---|---|----|----|----|----|----|----|----|----|----|----|----|----|----|----|----|----|----|----|----|----|----|----|
| 0 | 1 | 2 | 3 | 4 | 5 | 6 | 7 | 8 | 9 | 10 | 11 | 12 | 13 | 14 | 15 | 16 | 17 | 18 | 19 | 20 | 21 | 22 | 23 | 24 | 25 | 26 | 27 | 28 | 29 | 30 | 31 |
| Offset | | | | | | | | | | | | | | | | | | | | | | | | | | | | | | | |
| Attributes | | | | | | | | | | | | | | | | | | | | | | | | | | | | | | | |

Offset (4 bytes): A 4-byte, unsigned integer value specifying the offset in bytes from the beginning of the **Token Groups** structure to the beginning of the serialized binary **systemID** for this external group.

Attributes (4 bytes): A 4-byte, unsigned integer value specifying the length in bytes of the serialized binary **systemID** for this external group.

2.2.3.4 Token Groups

The **Token Groups** structure contains the serialized binary **SystemIDs** for a collection of external groups.

| | | | | | | | | | | | | | | | | | | | | | | | | | | | | | | | |
|---------------------------------|---|---|---|---|---|---|---|---|---|----|----|----|----|----|----|----|----|----|----|----|----|----|----|----|----|----|----|----|----|----|----|
| 0 | 1 | 2 | 3 | 4 | 5 | 6 | 7 | 8 | 9 | 10 | 11 | 12 | 13 | 14 | 15 | 16 | 17 | 18 | 19 | 20 | 21 | 22 | 23 | 24 | 25 | 26 | 27 | 28 | 29 | 30 | 31 |
| GroupCount | | | | | | | | | | | | | | | | | | | | | | | | | | | | | | | |
| OffsetsAndAttributes (variable) | | | | | | | | | | | | | | | | | | | | | | | | | | | | | | | |
| ... | | | | | | | | | | | | | | | | | | | | | | | | | | | | | | | |
| GroupSystemIds (variable) | | | | | | | | | | | | | | | | | | | | | | | | | | | | | | | |
| ... | | | | | | | | | | | | | | | | | | | | | | | | | | | | | | | |

GroupCount (4 bytes): A 4-byte, unsigned integer value specifying the number of external groups' **SystemIDs** that are serialized in this structure.

OffsetsAndAttributes (variable): A variable-length serialized array containing **GroupCount** elements consisting of **Token Group Offset and Attributes** structures specifying the lengths and offsets of the serialized binary **SystemIDs** for the corresponding external groups, one for each external group's **SystemID** in the collection.

GroupSystemIds (variable): A variable-length field containing the collection of serialized binary **SystemIDs** for the external groups. Each external group's **SystemID** starts at the offset value in bytes from the beginning of the **Token Groups** structure and has the length in bytes specified by the **Attributes** value in the **OffsetsAndAttributes** array element corresponding to the external group.

2.2.3.5 WSS ACE

An ACE structure specifying the individual access rights of a principal.

| | | | | | | | | | | | | | | | | | | | | | | | | | | | | | | | |
|-------------|---|---|---|---|---|---|---|---|---|---|---|---|---|---|---|---|---|---|---|---|---|---|---|---|---|---|---|---|---|---|---|
| 0 | 1 | 2 | 3 | 4 | 5 | 6 | 7 | 8 | 9 | 0 | 1 | 2 | 3 | 4 | 5 | 6 | 7 | 8 | 9 | 0 | 1 | 2 | 3 | 4 | 5 | 6 | 7 | 8 | 9 | 0 | 1 |
| PrincipalId | | | | | | | | | | | | | | | | | | | | | | | | | | | | | | | |
| PermMask | | | | | | | | | | | | | | | | | | | | | | | | | | | | | | | |
| ... | | | | | | | | | | | | | | | | | | | | | | | | | | | | | | | |

PrincipalId (4 bytes): A 4-byte, signed integer specifying the User Identifier of the principal for this ACE.

PermMask (8 bytes): A **WSS Rights Mask** containing the list of rights that are granted to the principal.

2.2.3.6 WSS ACL Format

The **WSS ACL Format** structure contains an array of **WSS_ACEs**.

| | | | | | | | | | | | | | | | | | | | | | | | | | | | | | | | |
|-----------------|---|---|---|---|---|---|---|---|---|---|---|---|---|---|---|---|---|---|---|---|---|---|---|---|---|---|---|---|---|---|---|
| 0 | 1 | 2 | 3 | 4 | 5 | 6 | 7 | 8 | 9 | 0 | 1 | 2 | 3 | 4 | 5 | 6 | 7 | 8 | 9 | 0 | 1 | 2 | 3 | 4 | 5 | 6 | 7 | 8 | 9 | 0 | 1 |
| Magic | | | | | | | | | | | | | | | | | | | | | | | | | | | | | | | |
| SecurityVersion | | | | | | | | | | | | | | | | | | | | | | | | | | | | | | | |
| ... | | | | | | | | | | | | | | | | | | | | | | | | | | | | | | | |
| NumAces | | | | | | | | | | | | | | | | | | | | | | | | | | | | | | | |
| Aces (variable) | | | | | | | | | | | | | | | | | | | | | | | | | | | | | | | |
| ... | | | | | | | | | | | | | | | | | | | | | | | | | | | | | | | |

Magic (4 bytes): A 4-byte, unsigned integer describing the version of the ACL. This version of the protocol MUST use the value 0xfef3.

SecurityVersion (8 bytes): An 8-byte, signed integer specifying the site collection's security version value, which was used to compute the ACL. This value is not currently used.

NumAces (4 bytes): A 4-byte, unsigned integer specifying the count of **WSS_ACEs** within this ACL.

Aces (variable): An array of **WSS_ACEs** for each of the principals in this ACL.

2.2.3.7 WSS External Group Map Cache Format

The **WSS External Group Map Cache Format** structure contains a cache of WSS External Group Records mapping external groups to the site groups that contain them.

| | | | | | | | | | | | | | | | | | | | | | | | | | | | | | | | | | | |
|---------------------------------|---|---|---|---|---|---|---|---|---|---|---|---|---|---|---|---|---|---|---|---|---|---|---|---|---|---|---|---|---|---|---|---|---|---|
| 0 | 1 | 2 | 3 | 4 | 5 | 6 | 7 | 8 | 9 | 1 | 0 | 1 | 2 | 3 | 4 | 5 | 6 | 7 | 8 | 9 | 2 | 0 | 1 | 2 | 3 | 4 | 5 | 6 | 7 | 8 | 9 | 3 | 0 | 1 |
| CachedVersion | | | | | | | | | | | | | | | | | | | | | | | | | | | | | | | | | | |
| ... | | | | | | | | | | | | | | | | | | | | | | | | | | | | | | | | | | |
| NumExternalGroupRecords | | | | | | | | | | | | | | | | | | | | | | | | | | | | | | | | | | |
| ExternalGroupRecords (variable) | | | | | | | | | | | | | | | | | | | | | | | | | | | | | | | | | | |
| ... | | | | | | | | | | | | | | | | | | | | | | | | | | | | | | | | | | |

CachedVersion (8 bytes): An 8-byte, signed integer specifying the version of this cached information.

NumExternalGroupRecords (4 bytes): A 4-byte, signed integer specifying the count of **WSS External Group Records** present in this cache.

ExternalGroupRecords (variable): A serialized collection of **WSS External Group Records**.

2.2.3.8 WSS Compressed Structures

The **WSS Compressed structure** uses the ZLIB Compressed Data Format Specification version 3.3 to compress a binary or string value to a binary format when save it in to the database.

The header of the **WSS Compressed structure** is specified as follows.

| | | | | | | | | | | | | | | | | | | | | | | | | | | | | | | | | | | |
|-------------------------------------|---|---|---|---|---|---|---|---|---|---|---------|---|---|---|---|---|---|---|---|---|---|---|---|---|---|---|---|---|---|---|---|---|---|---|
| 0 | 1 | 2 | 3 | 4 | 5 | 6 | 7 | 8 | 9 | 1 | 0 | 1 | 2 | 3 | 4 | 5 | 6 | 7 | 8 | 9 | 2 | 0 | 1 | 2 | 3 | 4 | 5 | 6 | 7 | 8 | 9 | 3 | 0 | 1 |
| ID | | | | | | | | | | | Version | | | | | | | | | | | | | | | | | | | | | | | |
| FileHeaderSize | | | | | | | | | | | | | | | | | | | | | | | | | | | | | | | | | | |
| OrigSize | | | | | | | | | | | | | | | | | | | | | | | | | | | | | | | | | | |
| Compressed Binary string (variable) | | | | | | | | | | | | | | | | | | | | | | | | | | | | | | | | | | |
| ... | | | | | | | | | | | | | | | | | | | | | | | | | | | | | | | | | | |

ID (2 bytes): MUST be 0xA8A9.

Version (2 bytes): For Microsoft SharePoint Foundation 2013, MUST be 0x3031 (ASCII "01")

FileHeaderSize (4 bytes): A 4-byte, unsigned integer specifying the size of the header. In Microsoft SharePoint Foundation 2013, it is 0x0C000000.

OrigSize (4 bytes): A 4-byte, unsigned integer specifying the size of the original content. It MUST be the size of the uncompressed **stream (1)** before compression.

Compressed Binary string (variable): The compressed string using zlib compression.

2.2.3.9 WSS External Group Record

The **WSS External Group Record** structure contains the mapping between an external group and the site groups that contain it.

| | | | | | | | | | | | | | | | | | | | | | | | | | | | | | | | |
|-----------------------------------|---|---|---|---|---|---|---|---|---|----|----|----|----|----|----|----|----|----|----|----|----|----|----|----|----|----|----|----|----|----|----|
| 0 | 1 | 2 | 3 | 4 | 5 | 6 | 7 | 8 | 9 | 10 | 11 | 12 | 13 | 14 | 15 | 16 | 17 | 18 | 19 | 20 | 21 | 22 | 23 | 24 | 25 | 26 | 27 | 28 | 29 | 30 | 31 |
| ExternalGroupSignatureSize | | | | | | | | | | | | | | | | | | | | | | | | | | | | | | | |
| ExternalGroupSignature (variable) | | | | | | | | | | | | | | | | | | | | | | | | | | | | | | | |
| ... | | | | | | | | | | | | | | | | | | | | | | | | | | | | | | | |
| NumGroupIds | | | | | | | | | | | | | | | | | | | | | | | | | | | | | | | |
| GroupIds (variable) | | | | | | | | | | | | | | | | | | | | | | | | | | | | | | | |
| ... | | | | | | | | | | | | | | | | | | | | | | | | | | | | | | | |

ExternalGroupSignatureSize (4 bytes): A 4-byte, signed integer specifying the size of the external group signature, in bytes.

ExternalGroupSignature (variable): An array of bytes specifying the signature for the external group using **UTF-8** encoding. The number of bytes is specified by the **ExternalGroupSignatureSize** field.

NumGroupIds (4 bytes): A 4-byte, signed integer specifying the count of Site Group Identifiers in this record.

GroupIds (variable): An array of 4-byte, signed integers specifying the Site Group Identifiers that contain this external group. The number of elements is specified by the **NumGroupIds** field.

2.2.3.10 WSS User Token

The **WSS User Token** structure contains an array of Site Group Identifiers.

| | | | | | | | | | | | | | | | | | | | | | | | | | | | | | | | |
|--------------|---|---|---|---|---|---|---|---|---|----|----|----|----|----|----|----|----|----|----|----|----|----|----|----|----|----|----|----|----|----|----|
| 0 | 1 | 2 | 3 | 4 | 5 | 6 | 7 | 8 | 9 | 10 | 11 | 12 | 13 | 14 | 15 | 16 | 17 | 18 | 19 | 20 | 21 | 22 | 23 | 24 | 25 | 26 | 27 | 28 | 29 | 30 | 31 |
| Magic | | | | | | | | | | | | | | | | | | | | | | | | | | | | | | | |
| TokenVersion | | | | | | | | | | | | | | | | | | | | | | | | | | | | | | | |
| ... | | | | | | | | | | | | | | | | | | | | | | | | | | | | | | | |
| NumGroupIds | | | | | | | | | | | | | | | | | | | | | | | | | | | | | | | |

| |
|---------------------|
| GroupIds (variable) |
| ... |

Magic (4 bytes): A 4-byte, unsigned integer specifying the version of the token format. This version of the protocol MUST use the value 0xcdcd3.

TokenVersion (8 bytes): An 8-byte, signed integer specifying the site collection's security version value, which was used to compute the token. This value is not currently used and MUST be ignored.

NumGroupIds (4 bytes): A 4-byte, unsigned integer specifying the count of Site Group Identifiers within this token.

GroupIds (variable): An array of 4-byte integers for each of the site groups the corresponding user belongs to. The number of elements in the array is specified by the **NumGroupIds** field.

2.2.4 Result Sets

The following common result sets are used by this protocol.

2.2.4.1 ACL and Permission Result Set

The **ACL and Permission Result Set** contains information about the permissions associated with a **security scope** in effect for a document. The **ACL and Permission Result Set** is defined using T-SQL syntax, as follows.

```
Acl          varbinary(max),
AnonymousPermMask bigint;
```

Acl: The binary serialization of the **WSS ACL Format** (section [2.2.3.6](#)) **access control list (ACL)** for the security scope in effect.

AnonymousPermMask: A **WSS Rights Mask** (section [2.2.2.15](#)) indicating the permissions granted to an anonymous user or a user who has no specific permissions on this document.

2.2.4.2 Custom Actions From Scope Result Set

This result set MUST return 1 row for each custom action retrieved. If there were no custom actions retrieved, this result set MUST NOT return any rows. This result set is defined using T-SQL syntax, as follows.

```
ScopeType    int;
ScopeId      uniqueidentifier;
Id           uniqueidentifier;
Properties    nvarchar(max);
Version      nvarchar(64);
```

ScopeType: The custom action scope.

ScopeId: The **site collection identifier**, site identifier, or list identifier for which the custom action resides.

Id: The custom action identifier.

Properties: The custom action data describing its functionality.

Version: The custom action version.

2.2.4.3 Domain Group Cache BEDS Update Result Set

The **Domain Group Cache BEDS Update Result Set** contains information to be used in recomputing the domain group map cache, which contains the mapping of external groups to the site groups that they are members of. The presence of the **Domain Group Cache BEDS Update Result Set** means the database's copy of the domain group map cache is out of date and **MUST** be recomputed to ensure that proper security checks can be made.

The **Domain Group Cache BEDS Update Result Set** is defined using T-SQL syntax, as follows.

```
tp_id          int,  
tp_SystemId    varbinary(512),  
GroupId        int;
```

tp_id: The identifier of an external group which is a member of a Site Group.

tp_SystemId: The **SystemId** of the external group.

GroupId: The Site Group Identifier of the Site Group containing the given **domain group**.

2.2.4.4 Domain Group Cache Versions Result Set

The **Domain Group Cache Versions Result Set** contains information about the version numbers associated with the Domain Group Map Caches on the front-end Web server and on the back-end database server for the specified Site Collection. A Domain Group Map Cache contains a serialized representation of the External Groups that are members of Site Groups in the Site Collection. The version numbers in this result set can be used to determine whether the Domain Group Map Caches on the front-end Web server or on the back-end database server are out of date and need to be refreshed. A special version number value of -2 indicates that the value **MUST NOT** be used for comparison.

When the **Domain Group Cache Versions Result Set** is returned, it **MUST** contain one row of version number data.

The **Domain Group Cache Versions Result Set** is defined using T-SQL syntax, as follows.

```
RealVersion    bigint,  
CachedVersion  bigint,  
FrontEndVersion  bigint;
```

RealVersion: The most recent version number of the domain group Map Cache information.

CachedVersion: The version number of the domain group Map Cache information on the back-end database server.

FrontEndVersion: The version number of the domain group Map Cache information on the front-end Web server.

2.2.4.5 Domain Group Cache WFE Update Result Set

The **Domain Group Cache WFE Update Result Set** contains the binary data needed to refresh the domain group map cache. If the **Domain Group Cache WFE Update Result Set** is returned, it indicates that the Back-end database server domain group map cache is up-to-date, and the front-end Web server cache can be refreshed if necessary.

The **Domain Group Cache WFE Update Result Set** is defined using T-SQL syntax, as follows.

```
DomainGroupMapCache          varbinary(max);
```

DomainGroupMapCache: A column containing the serialized domain group map cache data. If the value of **FrontEndVersion** is greater than or equal to the value of **CachedVersion** in the results in the **Domain Group Cache Versions Result Set** (section [2.2.4.4](#)), this MUST be NULL.

2.2.4.6 Document Content Metadata Result Set

The **Document Content Metadata Result Set** contains the metadata for the document's binary stream (1).

```
{Size}                        int,  
{SiteRbsCollectionId}        int,  
{Version}                    int,  
{InternalVersion}           int,  
{HistVersion}               int,  
{Id}                         uniqueidentifier,  
{DirName}                   nvarchar(256),  
{LeafName}                   nvarchar(128),  
{ParentId}                   uniqueidentifier,  
{SetupPathVersion}          tinyint,  
{SetupPath}                  nvarchar(255),  
{Dirty}                      bit,  
{DocFlags}                   int,  
{Level}                      tinyint,  
{DoclibRowId}               int,  
{VirusVendorID}             int,  
{VirusStatus}               int,  
{VirusInfo}                  nvarchar(255),  
{VirusInfoEx}               varbinary(max),  
{ContentVersion}            int,  
{NextBSN}                    bigint,  
{StreamSchema}              byte,  
{SiteId}                     uniqueidentifier
```

{Size}: The size of the document stream, in bytes.

{SiteRbsCollectionId}: The identifier for the remote **BLOB** storage collection for the site collection, or zero if remote BLOB storage is not configured for this database.

{Version}: The current **displayed version** number of the document.

{InternalVersion}: The current **internal version number** of the document.

{HistVersion}: The user interface (UI) version number for the document.

{Id}: The document identifier (2) of the requested document.

{DirName}: The **directory name** of the requested document.

{LeafName}: The **leaf name** of the requested document.

{ParentId}: The document identifier (2) of the item's parent container.

{SetupPathVersion}: For an uncustomized document, this parameter governs the **setup path** location to which the **{SetupPath}** fragment is relative. This value MUST be NULL if the document does not exist, and it is undefined for a document that was never uncustomized. The value MUST be one of the following.

| Value | Description |
|-------|---|
| 2 | Relative to the install location of Windows SharePoint Services 2.0 on the front-end Web server (for example, Program Files\Common Files\Microsoft Shared\Web Server Extensions\60). |
| 3 | Relative to the install location of Windows SharePoint Services 3.0 on the front-end Web server (for example, Program Files\Common Files\Microsoft Shared\Web Server Extensions\12). |
| 4 | Relative to the install location of Microsoft SharePoint Foundation 2010 on the front-end Web server (for example, Program Files\Common Files\Microsoft Shared\Web Server Extensions\14). |
| 15 | Relative to the install location of Microsoft SharePoint Foundation 2013 on the front-end Web server (for example, Program Files\Common Files\Microsoft Shared\Web Server Extensions\15). |

{SetupPath}: For a document that has never been uncustomized, this contains the setup path fragment relative to the base setup path where the content stream (1) of this document can be found, as described in **{SetupPathVersion}**. Otherwise, this parameter MUST be NULL.

{Dirty}: This parameter MUST be set to one, if this document has had dependency update processing performed; otherwise, it MUST be set to zero. If the document does not have a content stream (1), the value is implementation-dependent and MUST be ignored.

{DocFlags}: A **Doc Flags** value (section [2.2.2.3](#)) describing the document.

{Level}: A publishing level value specifying the publishing status of this document.

{DoclibRowId}: The identifier for a row in a document library for this document. If the requested document is not contained in a list, this value MUST be NULL.

{VirusVendorID}: The identifier of the anti-virus vendor that processed this document. This value MUST be NULL, if the document has not been processed by an anti-virus scanner.

{VirusStatus}: The **Virus Status** (section [2.2.1.2.17](#)) of the document. This value MUST be NULL, if the requested document does not exist or if it has not been processed by an anti-virus scanner.

{VirusInfo}: A anti-virus scanner specific message returned by the anti-virus scanner when it last processed the document.

{VirusInfoEx}: A binary value that specifies extensible virus information for this document, which is opaque to the back-end server.

{ContentVersion}: A counter used for internal conflict detection that is incremented any time a change is made to the binary contents of this document.

{NextBSN}: The current binary large object (BLOB) sequence number of the requested document.

{StreamSchema}: The current **stream schema** of the document being requested.

{SiteId}: The site collection identifier of the site collection containing the document being requested.

2.2.4.7 Document Content Stream Result Set

The **Document Content Stream Result Set** contains a row for each of the document's **stream binary pieces**.

| | |
|-------------------|-------------------|
| {ExpirationUTC} | datetime, |
| {DocId} | uniqueidentifier, |
| {SiteId} | uniqueidentifier, |
| {Partition} | byte, |
| {BSN} | bigint, |
| {StreamId} | bigint, |
| {Type} | byte, |
| {Size} | int, |
| {Content} | varbinary(max), |
| {RbsResReference} | varbinary(800) |

{ExpirationUTC}: The time stamp, in **UTC** format, of when this stream binary piece **expires**.

{DocId}: The document identifier (2) of the requested document.

{SiteId}: The site collection identifier of the site collection containing the requested document.

{Partition}: The **stream partition** that this stream binary piece belongs to.

{BSN}: The BLOB sequence number of this stream binary piece.

{StreamId}: The **stream identifier** of this stream binary piece.

{Type}: The stream (1) type of this stream binary piece.

{Size}: The size of the stream binary piece, in bytes.

{Content}: The data of the stream binary piece.

{RbsResReference}: This value is used in remote BLOB storage and is opaque to the back-end database server. For additional information regarding remote BLOB storage, see [\[MS-WSSO\]](#) section 2.1.2.3.8.

2.2.4.8 Document Metadata Result Set

The **Document Metadata Result Set** returns the metadata for a document.

The **Document Metadata Result Set** is defined using T-SQL syntax, as follows.

| | |
|--------------------------|-------------------|
| Id | uniqueidentifier, |
| {FullUrl} | nvarchar(260), |
| Type | tinyint, |
| MetaInfoTimeLastModified | datetime, |
| MetaInfo | varbinary(max), |
| Size | int, |
| TimeCreated | datetime, |
| TimeLastModified | datetime, |
| ETagVersion | int, |

| | |
|------------------------|-------------------|
| DocFlags | int, |
| {ListType} | int, |
| {tp_Name} | int, |
| {ListTitle} | int, |
| {CacheParseId} | uniqueidentifier, |
| {GhostDirName} | int, |
| {GhostLeafName} | int, |
| tp_Login | nvarchar(255), |
| CheckoutDate | datetime, |
| CheckoutExpires | datetime, |
| VirusStatus | int, |
| VirusInfo | nvarchar(255), |
| VirusInfoEx, | varbinary(max), |
| SetupPathVersion | tinyint, |
| SetupPath | nvarchar(255), |
| SetupPathUser | nvarchar(255), |
| NextToLastTimeModified | datetime, |
| UIVersion | int, |
| CheckinComment | nvarchar(1023), |
| WelcomePageUrl | nvarchar(260), |
| WelcomePageParameters | nvarchar(max), |
| {tp_Flags} | int, |
| Acl | varbinary(max), |
| AnonymousPermMask | bigint, |
| DraftOwnerId | int, |
| Level | tinyint, |
| ParentVersion | int, |
| TransformerId | uniqueidentifier, |
| ParentLeafName | nvarchar(128), |
| ProgId | nvarchar(255), |
| DoclibRowId | int, |
| {tp_DefaultWorkflowId} | int, |
| ListId | uniqueidentifier, |
| ItemChildCount | int, |
| FolderChildCount | int, |
| MetaInfoVersion | int, |
| {CurrentVerMetaInfo} | varbinary(max), |
| ContentVersion | int, |
| {ContentVersionDirty} | bit, |
| {NextBSN} | bigint, |
| {StreamSchema} | byte, |
| {InternalVersion} | int |

Id: The document identifier (2) of the requested document.

{FullUrl}: The full **store-relative form** URL for the document being requested.

Type: The **Document Store Type** (section [2.2.2.4](#)) of this document.

MetaInfoTimeLastModified: A time stamp in UTC format specifying the last time the **MetaInfo** value of this document was changed, which is useful for providing minimal metadata returns to clients. This value MUST be NULL, if the **MetaInfo** column value of the document has never been changed.

MetaInfo: A **metadict** for this document. The metadict format is specified in [\[MS-FPSE\]](#) section 2.2.2.2.11. This value MUST be NULL if the document does not have any metadict associated with it.

Size: The number of bytes in the document stream of the document. This value can be NULL if the document is a folder or site **Document Store Type**.

TimeCreated: A time stamp in UTC format that specifies when this document was created.

TimeLastModified: A time stamp in UTC format that specifies when the document was last saved. This value does not necessarily correspond to the actual time when the document was last modified.

ETagVersion: A counter used for internal conflict detection that is incremented any time a change is made to this document.

DocFlags: A **Doc Flags** value (section [2.2.2.3](#)) describing the document. This value can be NULL.

{ListType}: This value MUST be NULL.

{tp_Name}: This value MUST be NULL.

{ListTitle}: This value MUST be NULL.

{CacheParseId}: This value MUST be NULL.

{GhostDirName}: A placeholder for a directory name. This value MUST be NULL.

{GhostLeafName}: A placeholder for a leaf name. This value MUST be NULL.

tp_Login: If this document exists and is currently checked out, this is the **login name** of the user to whom it is checked out. In all other cases, this is NULL.

CheckoutDate: A time stamp in UTC format specifying when this document was checked out. This value MUST be NULL if the document has never been checked out.

CheckoutExpires: A time stamp in UTC format that specifies when the short-term lock for this document will expire. If this date is in the past, the document SHOULD be treated as unlocked. This value can be NULL if no short-term lock has been placed on the document.

VirusStatus: An enumerated type specifying the current virus state of this document. This value can be NULL if it has not been processed by a virus scanner. Valid values are listed in the **Virus Status** (section [2.2.1.2.17](#)).

VirusInfo: A string containing a provider specific message returned by the virus scanner when it last processed the document. This value can be NULL if it has not been processed by a virus scanner.

VirusInfoEx: A binary value that specifies extensible virus information for this document, which is opaque to the back-end server.

SetupPathVersion: For an uncustomized document, this governs the setup path location with which the **{SetupPath}** fragment is relative. This value MUST NOT be NULL. The following values are valid.

| Value | Description |
|-------|--|
| 2 | The SetupPath is relative to the install location of Windows SharePoint Services 2.0 on the front-end Web server (for example, Program Files\Common Files\Microsoft Shared\Web Server Extensions\60). |
| 3 | The SetupPath is relative to the install location of Windows SharePoint Services 3.0 on the front-end Web server (for example, Program Files\Common Files\Microsoft Shared\Web Server |

| Value | Description |
|-------|---|
| | Extensions\12). |
| 4 | The SetupPath is relative to the install location of Microsoft SharePoint Foundation 2010 on the front-end Web server (for example, Program Files\Common Files\Microsoft Shared\Web Server Extensions\14). |
| 15 | The SetupPath is relative to the install location of Microsoft SharePoint Foundation 2013 on the front-end Web server (for example, Program Files\Common Files\Microsoft Shared\Web Server Extensions\15). |

SetupPath: For a document that is now or once was uncustomized, this contains the setup path fragment relative to the base setup path described earlier by the **SetupPathVersion** value, where the content stream (1) of this document can be found. This value can be NULL.

SetupPathUser: If this document is now or once was uncustomized, this contains the login name of the user that created the uncustomized document. This value can be NULL.

NextToLastTimeModified: The value of **TimeLastModified** from the previous time when the document was last saved. If the **NextToLastTimeModified** value matches the **TimeLastModified** value when the rename occurred and the client has a document that it has successfully fixed up, the client can safely submit the document to the front-end Web server despite what appears to be an intervening edit to the document. This value can be NULL.

UIVersion: The UI version number for the document. This value MUST be NULL in the case of a document that does not exist.

CheckinComment: An optional description provided when a document is checked in or published, which could be displayed in the version management UI. This value can be NULL.

WelcomePageUrl: If this document is a folder, this specifies an optional page to redirect to when the folder is requested with an **HTTP GET** operation. The URL is relative to the URL of the folder itself and MUST be subsumed by that folder. Attempts to break out of the folder such as ".././somepage.aspx" are not valid. This value can be NULL.

WelcomePageParameters: Contains optional URL parameters to specify as part of the **WelcomePageUrl** value. These parameters start at either the query string signifier '?' or the bookmark signifier '#'. This value can be NULL.

{tp_Flags}: A **List Flags** value (section [2.2.2.5](#)) describing the list that contains this document.

Acl: The binary serialization of the **WSS ACL Format** (section [2.2.3.6](#)) ACL for this document. This is either explicitly defined or inherited from the parent object of the document. This value can be NULL if a WSS ACL is not defined for the document.

AnonymousPermMask: A **WSS Rights Mask** (section [2.2.2.15](#)) that indicates the permissions granted to a user that is anonymous, or has no specific permissions, to this document. This value can be NULL if anonymous access to the document is not allowed.

DraftOwnerId: The **User Identifier** (section [2.2.1.1.13](#)) of the user that published this document as a draft. This value MUST only be non-NULL if the requested document exists and is a draft **version**.

Level: A **Publishing Level Type** value (section [2.2.2.6](#)) specifying the publishing status of this document.

ParentVersion: If the document is a transformed version of another document, this is the user interface (UI) version value from the original document. This value MUST be NULL if the document is not the product of a document transformation.

TransformerId: If the document is a transformed version of another document, this is the GUID of the agent that performed the transformation. This value MUST be NULL if the document is not the product of a document transformation.

ParentLeafName: If the document is a transformed version of another document and the original document is in the same folder as the transformed document, this is the leaf name of the original document. If either is moved, the relationship is broken. This value MUST be NULL if the document is not the product of a document transformation.

ProgId: Designates a preferred application to open the document. The **ProgId** is used to distinguish between different applications that save files with a given **file extension** (that is, different editors for HTML or XML files). This value MUST be NULL if the parser did not specify a **ProgId** when the document was saved.

DoclibRowId: The identifier for a row in a document library for this document. If the requested document is not contained in a list, this value MUST be NULL.

{tp_DefaultWorkflowId}: The **Workflow Identifier** (section [2.2.1.1.16](#)) corresponding to the workflow (2) to be invoked if this document is in a moderated list and is submitted for approval as part of a **check in**. This value MUST be NULL.

ListId: The **List Identifier** (section [2.2.1.1.5](#)) of the list that contains the requested document. If the document is not contained in a list, this value MUST be NULL.

ItemChildCount: The number of non-folder (those whose **Document Store Type** is not folder) children of this document.

FolderChildCount: The number of folder (those whose **Document Store Type** is folder) children of this document.

MetaInfoVersion: A counter used for internal conflict detection that is incremented any time a change is made to the metadict for this document.

{CurrentVerMetaInfo}: This value is not used and MUST be NULL.

ContentVersion: A counter used for internal conflict detection that is incremented any time a change is made to the binary contents of this document. This value MUST be NULL if the document does not exist.

{ContentVersionIsDirty}: This value specifies whether the **ContentVersion** value can be used for conflict detection. If the **ContentVersion** value can be used for conflict detection or the **ContentVersion** value is NULL, this value MUST be zero; otherwise, the value MUST be one.

{NextBSN}: The current BLOB sequence number of the document being returned.

{StreamSchema}: The current stream schema of the document being returned.

{InternalVersion}: The internal version number of the document being returned.

2.2.4.9 Document Version Metadata Result Set

The **Document Version Metadata Result Set** contains the metadata about the requested version of the document.

The **Document Version Metadata Result Set** MUST be returned only if *@Version* is not negative. If the document exists, the **Document Version Metadata Result Set** MUST contain one row; otherwise, it MUST contain no rows.

The **Document Version Metadata Result Set** is defined using T-SQL syntax, as follows.

```

Id                               uniqueidentifier,
{FullUrl}                        nvarchar(260),
Type                             tinyint,
MetaInfoTimeLastModified        datetime,
MetaInfo                         varbinary(max),
Size                             int,
TimeCreated                     datetime,
TimeCreated                     datetime,
ETagVersion                     int,
DocFlags                        int,
{ListType}                      int,
{tp_Name}                       nvarchar(38),
{ListTitle}                    nvarchar(255),
{CacheParseId}                 uniqueidentifier,
{GhostDirName}                 nvarchar(256),
{GhostLeafName}                nvarchar(128),
tp_Login                        nvarchar(255),
CheckoutDate                   datetime,
CheckoutExpires                 datetime,
VirusStatus                    int,
VirusInfo                      nvarchar(255),
VirusInfoEx,                   varbinary(max),
SetupPathVersion               tinyint,
SetupPath                      nvarchar(255),
SetupPathUser                  nvarchar(255),
NextToLastTimeModified         datetime,
UIVersion                      int,
CheckinComment                 nvarchar(1023),
WelcomePageUrl                 nvarchar(260),
WelcomePageParameters          nvarchar(max),
{tp_Flags}                     bigint,
Acl                             varbinary(max),
AnonymousPermMask             int,
DraftOwnerId                   int,
Level                          tinyint,
ParentVersion                  int,
TransformerId                 uniqueidentifier,
ParentLeafName                 nvarchar(128),
ProgId                        nvarchar(255),
DoclibRowId                   int,
{tp_DefaultWorkflowId}         uniqueidentifier,
ListId                         uniqueidentifier;
ItemChildCount                int;
FolderChildCount               int;
MetaInfoVersion                int;
{MetaInfo}                    varbinary(MAX),
ContentVersion                 int,
{ContentVersionDirty}          bit,
NextBSN                       bigint,
StreamSchema                   byte,
InternalVersion                int

```

Id: The document identifier (2) of the requested document.

{FullUrl}: The full store-relative form URL for the document being requested.

Type: The **Document Store Type** (section [2.2.2.4](#)) of this document.

MetaInfoTimeLastModified: A time stamp in UTC format specifying the last time the **MetaInfo** value of this document was changed. This value MUST be NULL if the **MetaInfo** column value of the document has never been changed.

MetaInfo: A metadict for this **document version**. The metadict format is specified in [\[MS-FPSE\]](#) section 2.2.2.2.11. This value MUST be NULL if the document does not have any metadict associated with it.

Size: The number of bytes in the document stream of the document version requested. This value can be NULL if the document is a folder or site **Document Store Type** (section [2.2.2.4](#)).

TimeCreated: A time stamp in UTC format specifying when this document was created.

TimeCreated: A time stamp in UTC format specifying when the document was last saved. This corresponds to the **TimeCreated** or **TimeLastModified** of the document version requested.

ETagVersion: A counter used for internal conflict detection that is incremented any time a change is made to this document.

DocFlags: A **Doc Flags** (section [2.2.2.3](#)) value describing this document. This value can be NULL if the document is a folder **Document Store Type**.

{ListType}: This value MUST be NULL.

{tp_Name}: This value MUST be NULL.

{ListTitle}: This value MUST be NULL.

{CacheParseId}: This value MUST be null.

{GhostDirName}: A placeholder for a directory name. This value MUST be NULL.

{GhostLeafName}: A placeholder for a leaf name. This value MUST be NULL.

tp_Login: If this document exists and is currently checked out, this is the login name of the user to whom it is checked out. In all other cases, this is NULL.

CheckoutDate: A time stamp in UTC format specifying when this document was checked out. This value can be NULL if the document is checked out.

CheckoutExpires: A time stamp in UTC format specifying when the short-term lock for this document will expire. If this date is in the past, the document SHOULD be treated as unlocked. This value can be NULL if no short-term lock has been placed on the document.

VirusStatus: An enumerated type specifying the current virus state of this document version. This value can be NULL if it has not been processed by a virus scanner. Valid values are listed in the **Virus Status** section [2.2.1.2.17](#).

VirusInfo: A string containing a provider specific message returned by the virus scanner when it last processed the document. This value can be NULL if it has not been processed by a virus scanner.

VirusInfoEx: A binary value that specifies extensible virus information for this document, which is opaque to the back-end server.

SetupPathVersion: For an uncustomized document, this governs the setup path location that the **SetupPath** fragment is relative to. This value MUST NOT be NULL. The following are values are valid.

| Value | Description |
|-------|---|
| 2 | The SetupPath is relative to the install location of Windows SharePoint Services 2.0 on the front-end Web server (for example, Program Files\Common Files\Microsoft Shared\Web Server Extensions\60). |
| 3 | The SetupPath is relative to the install location of Windows SharePoint Services 3.0 on the front-end Web server (for example, Program Files\Common Files\Microsoft Shared\Web Server Extensions\12). |
| 4 | The SetupPath is relative to the install location of Microsoft SharePoint Foundation 2010 on the front-end Web server (for example, Program Files\Common Files\Microsoft Shared\Web Server Extensions\14). |
| 15 | The SetupPath is relative to the install location of Microsoft SharePoint Foundation 2013 on the front-end Web server (for example, Program Files\Common Files\Microsoft Shared\Web Server Extensions\15). |

SetupPath: For a document that is now or once was uncustomized, this contains the setup path fragment relative to the base setup path described earlier by the **SetupPathVersion** value, where the content stream (1) of this document can be found. This value can be NULL.

SetupPathUser: If this document is now or once was uncustomized, this contains the login name of the user that created the uncustomized document. This value can be NULL.

NextToLastTimeModified: The value of **TimeLastModified** from the previous time when the document was last saved. If the **NextToLastTimeModified** value matches the **TimeLastModified** value when the rename occurred and the client has a document that it has successfully fixed up, the client can safely submit the document to the front-end Web server despite what appears to be an intervening edit to the document. This value can be NULL.

UIVersion: The user interface (UI) version number for the document. This value can be produced as the integer counter described earlier (the first **Version** field). This value MUST match *@Version*.

CheckinComment: An optional description provided when a document is checked in, which could be displayed in version management UI. This value can be NULL.

WelcomePageUrl: If this document is a folder, this specifies an optional page to redirect to when the folder is requested with an HTTP GET operation. The URL is relative to the URL of the folder itself and MUST be subsumed by that folder. Attempts to break out of the folder such as `".././somepage.aspx"` are not valid. This value can be NULL.

WelcomePageParameters: Contains optional URL parameters to specify as part of the **WelcomePageUrl** value. These parameters start at either the query string signifier '?' or the bookmark signifier '#'. This value can be NULL.

{tp_Flags}: A **List Flags** value (section [2.2.2.5](#)) describing the list that contains this document. This value MUST be NULL.

Acl: The binary serialization of the **WSS ACL Format** (section [2.2.3.6](#)) ACL for this document. This is either explicitly defined or inherited from the parent object of the document.

AnonymousPermMask: A **WSS Rights Mask** (section [2.2.2.15](#)) that indicates the permissions granted to a user that is anonymous, or has no specific permissions, to this document. This value can be NULL if anonymous access to the document is not allowed.

DraftOwnerId: The **User Identifier** (section [2.2.1.1.13](#)) of the user that published this document as a draft. This value is only non-NULL if the requested document is a draft version.

Level: A **Publishing Level Type** (section [2.2.2.6](#)) value specifying the publishing status of this document. This value MUST match @Level.

ParentVersion: If the document is a transformed version of another document (see **Doc Flags** value 0x00000400), this is the **UIVersion** value from the parent document. This value MUST be NULL if the document is not a child of a document transformation.

TransformerId: If the document is a transformed version of another document, this is the GUID of the agent that performed the transformation. This value MUST be NULL if the document is not the product of a document transformation.

ParentLeafName: If the document is a transformed version of another document and the original document is in the same folder as the transformed document, this is the leaf name of the original document. If either is moved, the relationship is broken. This value MUST be NULL if the document is not the product of a document transformation.

ProgId: Designates a preferred application to open the document. The **ProgId** is used to distinguish between different applications that save files with a given file extension (that is, different editors for HTML or XML files). This value MUST be NULL if the parser did not specify a **ProgId** when the document was saved.

DoclibRowId: The identifier for a row in a document library for this document. If the requested document is not contained in a list, this value MUST be NULL.

{tp_DefaultWorkflowId}: A placeholder for the **Workflow Identifier** (section [2.2.1.1.16](#)) corresponding to a workflow (2) invoked as part of a check in on a moderated list. This value MUST be NULL.

ListId: The **List Identifier** (section [2.2.1.1.5](#)) of the list containing the requested document. If the document is not contained in a list, this value MUST be NULL.

ItemChildCount: The number of non-folder (those whose **Document Store Type** is not folder) children of this document.

FolderChildCount: The number of folder (those whose **Document Store Type** is folder) children of this document.

MetaInfoVersion: A counter incremented any time a change is made to the metainfo for this document and used for internal conflict detection.

{MetaInfo}: A metadict for this document. The metadict format is specified in [\[MS-FPSE\]](#) section 2.2.2.2.11. This value MUST be NULL if the document does not have any metadict associated with it.

ContentVersion: A counter used for internal conflict detection that is incremented any time a change is made to the binary contents of this document. This value MUST be NULL if the document does not exist.

{ContentVersionIsDirty}: This value specifies whether the **ContentVersion** value can be used for conflict detection. If the **ContentVersion** value can be used for conflict detection or the **ContentVersion** value is NULL, this value MUST be zero; otherwise, it MUST be one.

{NextBSN}: The current BLOB sequence number of the document being returned.

{StreamSchema}: The current stream schema of the document being returned.

{InternalVersion}: The internal version number of the document being returned.

2.2.4.10 Empty Result Set

The **Empty Result Set** is defined using T-SQL syntax, as follows.

```
{No column name}      Not Applicable
```

2.2.4.11 Event Receivers Result Set

The **Event Receivers Result Set** contains information about the event receivers defined for an event host. This result set **MUST** contain one row for each event receiver registered for the event host.

The **Event Receivers Result Set** is defined using **T-SQL** syntax, as follows.

| | |
|------------------------|-------------------|
| Id | uniqueidentifier, |
| Name | nvarchar(256), |
| SiteId | uniqueidentifier, |
| WebId | uniqueidentifier, |
| HostId | uniqueidentifier, |
| HostType | int, |
| ItemId | int, |
| DirName | nvarchar(256), |
| LeafName | nvarchar(128), |
| Synchronization | int, |
| Type | int, |
| SequenceNumber | int, |
| RemoteUrl | nvarchar(4000), |
| Assembly | nvarchar(256), |
| Class | nvarchar(256), |
| SolutionId | varbinary(512), |
| Data | nvarchar(256), |
| Filter | nvarchar(256), |
| SourceId | varbinary(512), |
| SourceType | int, |
| Credential | int, |
| ContextType | varbinary(16), |
| ContextEventType | varbinary(16), |
| ContextId | varbinary(16), |
| ContextObjectId | varbinary(16), |
| ContextCollectionId | varbinary(16), |
| Hash | nvarchar(50), |
| ValidatorsHash | char(64), |
| ValidationErrorUrl | nvarchar(4000), |
| ValidationErrorMessage | nvarchar(4000) |

Id: The **Event Receiver Identifier** (section [2.2.1.1.3](#)) of the event receiver.

Name: The **display name** of the event receiver.

SiteId: The site collection identifier for a site collection that contains the event host on which the event receiver is registered.

WebId: The site identifier for the site that contains the event host on which the event receiver is registered.

HostId: The document identifier (2) for the event host on which the event receiver is registered.

HostType: The **Event Host Type** (section [2.2.1.2.5](#)) of the event host on which the event receiver is registered.

ItemId: Reserved. The server MUST default this value to NULL and a client MUST NOT use this value.

DirName: Reserved. The server MUST default this value to NULL and a client MUST NOT use this value.

LeafName: Reserved. The server MUST default this value to NULL and a client MUST NOT use this value.

Synchronization: Contains the execution behavior of the event receiver. The value MUST be one of the following values.

| Value | Description |
|-------|--|
| 0 | If the Event Receiver Type (section 2.2.1.2.6) specified by the Type column is less than 10001, the execution behavior of the event receiver MUST be synchronous. |
| 1 | The execution behavior of the event receiver MUST be synchronous. |
| 2 | The execution behavior of the event receiver MUST be asynchronous. |

Type: The **Event Receiver Type** of the event receiver.

SequenceNumber: An ordinal value that determines the relative order in which the event receiver is triggered. **SequenceNumber** MUST be greater than or equal to zero, and less than or equal to 65535.

RemoteUrl: The URL of the remote event receiver.

Assembly: The name of the .NET assembly that contains the implementation of the event receiver.

Class: The name of the .NET class definition that contains the implementation of the event receiver.

SolutionId: The sandboxed solution identifier of the sandboxed solution.

Data: Additional data persisted on behalf of the event receiver implementation, to be passed to the event receiver.

Filter: Reserved. The server MUST default this value to NULL and a client MUST NOT use this value.

SourceId: The **feature identifier** or **content type identifier** of the feature or content type that registered the event receiver. If the event receiver was not registered by a feature or content type, the value MUST be NULL.

SourceType: An integer value that specifies the source of the registration for the event receiver. The value MUST be one of the following values.

| Value | Description |
|-------|---|
| 0 | The event receiver does not come from a specially treated source. |
| 1 | A content type registered the event receiver. |
| 2 | A feature registered the event receiver. |

Credential: Reserved. The server MUST default this value to NULL and a client MUST NOT use this value.

ContextType: The workflow identifier of the workflow (2) that the event (2) relates to, if any.

ContextEventType: Reserved. The server MUST default this value to NULL and a client MUST NOT use this value.

ContextId: The workflow identifier for the registered workflow (2), if any.

ContextObjectId: The document identifier (2) for the object instance that the workflow (2) is registered against, if any.

ContextCollectionId: A workflow identifier for the workflow (2) instance that manages the event receiver, if any.

Hash: The implementation-specific **hash** of the content of the sandboxed solution.

ValidatorsHash: The implementation-specific hash of the sandboxed solution validator that validated the sandboxed solution.

ValidationErrorUrl: The URL to render the sandboxed solution validator validation failed. If validation succeeded, it MUST be NULL.

ValidationErrorMessage: If the sandboxed solution validator validation failed, this stores an error message string. Otherwise, it MUST be NULL.

2.2.4.12 Individual URL Security Result Set

The **Individual URL Security Result Set** contains security information about a document.

The **Individual URL Security Result Set** is defined using T-SQL syntax, as follows.

```

{ListId}                uniqueidentifier,
Acl                     varbinary(max),
AnonymousPermMask      bigint,
{IsAttachment}         bit,
{NeedManageListRight} bit,
{BaseType}             int,
{ExcludedType}         int,
{ListFlags}            bigint,
{Level}                tinyint,
{DraftOwnerId}         int,
{DocType}              tinyint,
{bNeedNoThrottle}     bit,
{ItemCount}            int,
{DoclibRowId}          int,
{DocFlags}             int;

```

{ListID}: The List Identifier of the list or document library containing the document location.

Acl: The **WSS ACL** for the security scope associated with the document location.

AnonymousPermMask: The **WSS Rights Mask** that applies to an anonymous user, or a user with no assigned permissions, in the security scope associated with the document location.

{IsAttachment}: A bit flag specifying whether the document location is an attachment or an attachment folder. This value MUST be set to 1 if the document location is an attachment or attachment folder; otherwise, it MUST be 0.

{NeedManageListRight}: A bit flag specifying whether the current user needs the **ManageLists** bit of the **WSS Rights Mask** set to write to the document location. This value MUST be set to 1 if the current user MUST have the **ManageLists** bit of the **WSS Rights Mask** set in the security scope of the document location to write the document; otherwise, it MUST be 0.

{BaseType}: The **List Base Type** of the list or document library containing the document location.

{ExcludedType}: Contains an enumerated value specifying whether the document location is within a special folder type in the containing list or document library. The following values are valid.

| Value | Description |
|-------|--|
| 0 | The document location is not contained in a special folder. |
| 1 | The document location is, or is contained within, a forms folder: a folder named "Forms" within a document library. |
| 2 | The document location is, or is contained within, a Web image folder: a folder named "_w" within a document library. |
| 3 | The document location is, or is contained within, a thumbnail folder: a folder named "_t" within a document library. |
| 4 | The document location is at the root folder of the list or document library. |

{ListFlags}: The List Flags of the list or document library containing the document location.

{Level}: The **Publishing Level Type** value specified for the document, or if the parameter was NULL, the **Publishing Level Type** of the **current version** of the document for the current user.

{DraftOwnerId}: The User Identifier of the principal that published this document as a draft. This value MUST be NULL if the document does not exist or does not have a draft version.

{DocType}: The **Document Store Type** (section [2.2.2.4](#)) of this document.

{bNeedNoThrottle}: If the list or document library containing the document location is a list or document library that can ignore throttle, then this value MUST be 1. Otherwise, it MUST be 0.

{ItemCount}: The number of the Items in list or document library containing the document location is a list or document library.

{DoclibRowId}: The row identifier of the document in the containing list or document library.

DocFlags: A **Doc Flags** (section [2.2.2.3](#)) value specifying information about the document.

2.2.4.13 Link Information Result Set

The **Link Information Result Set** returns information about each **forward link** from the document and backward link to the document within the site collection.

The **Link Information Result Set** is defined using T-SQL syntax, as follows.

| | |
|---------------|-------------------|
| LinkDirName | nvarchar(256), |
| LinkLeafName | nvarchar(128), |
| LinkType | tinyint, |
| LinkSecurity | tinyint, |
| LinkDynamic | tinyint, |
| LinkServerRel | bit, |
| LinkStatus | tinyint, |
| PointsToDir | bit, |
| WebPartId | uniqueidentifier, |
| LinkNumber | int, |
| WebId | uniqueidentifier, |
| Search | nvarchar(max), |
| FieldId | uniqueidentifier; |

LinkDirName: Contains the directory name of the link target.

LinkLeafName: Contains the leaf name of the link target.

LinkType: The **LinkType** value of the link. This value MUST be NULL for a backward link.

LinkSecurity: The **LinkSecurity** value of the forward link, which specifies whether the scheme of the link is HTTP or HTTPS. This value MUST be NULL for a backward link.

LinkDynamic: The **LinkDynamic** value of the forward link, which specifies whether the link is to a special type of target. This value MUST be NULL for a backward link.

LinkServerRel: A bit flag which specifies whether the link URL is **server-relative URL** or not. A value of 1 specifies a server-relative URL. This value MUST be NULL for a backward link.

LinkStatus: The **Document Store Type** value of the document targeted by a forward link. This value MUST be 128 for a backward link. If the forward link target is a document that does not exist, or if this link refers to a target that exists outside the specified site collection, or if it refers to a location that could not be verified, this value MUST be NULL.

PointsToDir: A bit flag specifying whether the target of the forward link was a directory and has been modified to target a welcome page. This value MUST be NULL for a backward link. For a forward link, if the link target is a directory where a welcome page is specified, the link MUST be changed to the URL of the welcome page and **PointsToDir** MUST be set to 1 so that the link can be distinguished from an explicit link to the welcome page; otherwise this value MUST be 0.

WebPartId: This value MUST be NULL.

LinkNumber: This value MUST be NULL.

WebId: This value MUST be NULL.

Search: This value MUST be NULL.

FieldId: This value MUST be NULL.

2.2.4.14 List Metadata Result Set

The **List Metadata Result Set** contains the metadata associated with a list.

The **List Metadata Result Set** is defined using T-SQL syntax, as follows.

| | |
|------------------------------------|-------------------|
| tp_Id | uniqueidentifier, |
| tp_Title | nvarchar(255), |
| tp_Modified | datetime, |
| tp_Created | datetime, |
| tp_LastDeleted | datetime, |
| tp_Version | int, |
| tp_BaseType | int, |
| tp_FeatureId | uniqueidentifier, |
| tp_ServerTemplate | int, |
| DirName | nvarchar(256), |
| LeafName | nvarchar(128), |
| DirName | nvarchar(256), |
| LeafName | nvarchar(128), |
| tp_ReadSecurity | int, |
| tp_WriteSecurity | int, |
| tp_Description | nvarchar(max), |
| {tp_Fields} | varbinary(max), |
| tp_Direction | int, |
| AnonymousPermMask | bigint, |
| tp_Flags | bigint, |
| tp_ThumbnailSize | int, |
| tp_WebImageWidth | int, |
| tp_WebImageHeight | int, |
| tp_ImageUrl | nvarchar(255), |
| tp_ItemCount | int, |
| tp_Author | int, |
| tp_HasInternalFGP | bit, |
| tp_ScopeId | uniqueidentifier, |
| Acl | varbinary(max), |
| tp_EventSinkAssembly | nvarchar(255), |
| tp_EventSinkClass | nvarchar(255), |
| tp_EventSinkData | nvarchar(255), |
| tp_EmailAlias | nvarchar(128), |
| tp_WebFullUrl | nvarchar(256), |
| tp_WebId | uniqueidentifier, |
| tp_WebTitle | nvarchar(255), |
| tp_Web | int, |
| tp_WebLanguage | int, |
| tp_WebCollation | smallint, |
| tp_SendToLocation | nvarchar(512), |
| {tp_MaxMajorVersionCount} | int, |
| {tp_MaxMajorwithMinorVersionCount} | int, |
| tp_MaxRowOrdinal | int, |
| tp_ListDataDirty | int, |
| tp_DefaultWorkflowId | uniqueidentifier, |
| {HasBackLookupRels} | bit, |
| tp_ContentTypes | varbinary(max), |
| tp_Subscribed | bit, |
| {ChildCount} | int, |
| tp_NoThrottleListOperations | bit, |
| tp_TitleResource | nvarchar(256), |
| tp_DescriptionResource | nvarchar(256), |
| tp_ValidationFormula | nvarchar(1024), |

```

tp_ValidationMessage      nvarchar(1024),
Followable                bit;

```

tp_Id: The List Identifier of the list.

tp_Title: The title of this list for display in the front-end Web server.

tp_Modified: A time stamp in UTC format specifying when this list was last modified.

tp_Created: A time stamp in UTC format specifying when this list was created.

tp_LastDeleted: A time stamp in UTC format specifying when an item was last deleted from this list. This value MUST default to NULL if no item has been deleted.

tp_Version: A counter incremented any time a change is made to the schema or other properties of this list and used for internal conflict detection.

tp_BaseType: The **List Base type** of this list. The following values are valid.

| Value | Description |
|-------|-------------------------|
| 0 | "Generic" list |
| 1 | Document library |
| 3 | "Discussion board" list |
| 4 | "Survey" list |
| 5 | "Issues" list |

tp_FeatureId: The Feature Identifier for the feature that defines the base schema of this list.

tp_ServerTemplate: The **list template identifier** that defines the base structure of this list.

DirName: The directory name of the location that contains this list.

LeafName: The leaf name of the location that contains this list.

DirName: The directory name of the default **document template (2)** in the list. This value can be NULL if a document template (2) is not defined for this list.

LeafName: The leaf name of the default document template (2) in the list. This value can be NULL if a document template (2) is not defined for this list.

tp_ReadSecurity: This signifies special restrictions that can be placed on list item access. The following values are valid.

| Value | Description |
|-------|--|
| 1 | No special restrictions. |
| 2 | Users can see only their own list items. The front-end Web server MUST NOT display list items to users without the ManageLists permissions unless the list item was created by that user (for example, tp_Author = @UserId). |

tp_WriteSecurity: This signifies special restrictions that can be placed on list item update. The following values are valid.

| Value | Description |
|-------|--|
| 1 | No special restrictions. |
| 2 | Users will see only their own list items. The front-end Web server MUST NOT allow users without the ManageLists permission to update a list item unless the list item was created by that user (for example, tp_Author = @UserId). |
| 4 | Users will not update any list items in this list. The front-end Web server MUST NOT allow users without the ManageLists permission to add or update list items in this list. |

tp_Description: The description of this list for display in the front-end Web server.

{tp_Fields}: This field MUST be NULL if the site or list has been flagged to cache all schema data; otherwise, it contains a Compressed structure. Uncompressed it contains an implementation-specific version string followed by an XML representation of the **field definitions**. The field definitions include display and interaction options. The XML MUST conform to the **FieldDefinitionDatabaseWithVersion** complex type, as specified in section [2.2.7.3.5](#).

tp_Direction: An enumerated value specifying the direction of text flow for front-end Web server elements presented by this list. The following values are valid.

| Value | Description |
|-------|-------------------------------------|
| 0 | No explicit direction is specified. |
| 1 | Text flow is left to right. |
| 2 | Text flow is right to left. |

AnonymousPermMask: A **WSS Rights Mask** that indicates the permissions granted to a user that is anonymous, or has no specific permissions, on this list.

tp_Flags: A **List Flags** value describing this list.

tp_ThumbnailSize: The width, in pixels, specified for use when creating thumbnail images of list items within this list. This value MUST be NULL for lists that do not have a **List Server Template** value of 109(Image Library Template). Thumbnail images are generated by the front-end Web server for documents and have implementation-specific capabilities.

tp_WebImageWidth: The width, in pixels, specified for use when creating Web images of list items within this list. This value MUST be NULL for lists that do not have a **List Server Template** value of 109(Image Library Template). Web images are generated by the front-end Web server for documents and have implementation-specific capabilities.

tp_WebImageHeight: The height, in pixels, specified for use when creating Web images of list items within this list. This value MUST be NULL for lists that do not have a **List Server Template** value of 109(Image Library Template).

tp_ImageUrl: The URL of the image used to represent this list.

tp_ItemCount: The number of list items that are stored within this list.

tp_Author: The identifier of the user who is listed as creating this list.

tp_HasInternalFGP: This flag is set to 1 if there have ever been list items for this list that have had a unique access control list (ACL) applied. Otherwise, this flag is set to 0.

tp_ScopeId: Unique identifier of the security scope for this list. This indicates the specific WSS ACL Format access control list (ACL) to use for calculating the permission settings on this list.

Acl: The binary serialization of the WSS ACL Format access control list (ACL) for this list. This MUST be used for the permissions for this list if the **tp_ScopeId** value of this list is set to unique security scope.

tp_EventSinkAssembly: The name of the .NET assembly that implements the **event sink** associated with this list. This value MUST default to NULL if no event sink has been associated with the list.

tp_EventSinkClass: The name of the .Net assembly class that implements the event sink associated with this list. This value MUST default to NULL if no event sink has been associated with the list.

tp_EventSinkData: Additional data persisted on behalf of the event sink implementation, to be passed to the event sink associated with this list. This value MUST default to NULL if no event sink has been associated with the list.

tp_EmailAlias: The **e-mail address** of the list. This e-mail address is used to allow files to be sent directly to this list through an implementation-specific e-mail handling feature. This value MUST default to NULL if no e-mail inserts server has been associated with the list.

tp_WebFullUrl: The complete store-relative form URL to the site that contains this list.

tp_WebId: The Site Identifier of the site that contains the list.

tp_WebTitle: The title, for display in the front-end Web server, of the site that contains this list.

tp_Web: The identifier of the site template for the site that contains this list.

tp_WebLanguage: The **language code identifier (LCID)** of the display language of the site that contains this list.

tp_WebCollation: The collation order for information in the site that contains this list.

tp_SendToLocation: Contains an implementation-specific string of the URL used to copy list items to alternative locations. This value MUST be NULL if no "Send To Location" has been associated with the list.

{tp_MaxMajorVersionCount}: If the list has versioning enabled, this field contains the number of **major versions** that will be retained for this document. All versions more than **tp_MaxMajorVersionCount** removed from the current version of the document are automatically removed at version creation time. A value of 0 specifies that versions aren't automatically removed for this list.

{tp_MaxMajorwithMinorVersionCount}: If the list has versioning enabled, this field contains the number of major versions that will have their associated minor versions retained for this document. All versions more than **tp_MaxMajorVersionCount** removed from the current version of the document are automatically removed at version creation time. A value of 0 specifies that versions aren't automatically removed for this list.

tp_MaxRowOrdinal: This specifies the maximum row ordinal used to store list items for this list. This value indicates an implementation-specific calculation for storage of list items within lists.

tp_ListDataDirty: This is set to 1 if the list items in this list require dependency update processing before their next access (for example, updating document link information by parsing each document).

tp_DefaultWorkflowId: The Workflow Identifier corresponding to the workflow (2) invoked if the document is in a moderated list and the document is submitted for approval as part of a check in. If the document does not exist, or is not contained in a list with a configured approval workflow (2), this value MUST be NULL.

{HasBackLookupReIs}: This bit is set to 1 if this list has any relationship lookup fields (2) with relationship delete behavior that cascades or relationship delete behavior that is restricted. Otherwise, it MUST be 0.

tp_ContentTypes: Compressed structure. Uncompressed it will get XML data specifying the content types registered for this list.

tp_Subscribed: Set to 1 if an alert (1) for changes to this list has been created in the past, signifying that additional processing needs to be performed.

{ChildCount}: If the document is contained within a list, this MUST be the sum total of list items and folders within the list. Otherwise, this MUST be the sum total of documents and folders that are contained within directory specified by the DirName column.

tp_NoThrottleListOperations: If this list is exempt from resource throttling operations, then this value MUST be 1. Otherwise, it MUST be 0.

tp_DescriptionResource: The resource token or resource identifier of the description for the site.

tp_ValidationFormula: A string representing the data validation criteria used to perform custom validation rules prior to the list being updated.

Followable: If this list is followable, then this value MUST be 1. Otherwise, it MUST be 0.

tp_ValidationMessage: A string containing text to display in the user interface when the list fails validation based on the data validation criteria represented by **tp_ValidationFormula**.

2.2.4.15 List Web Parts Result Set

The **List Web Parts Result Set** contains information about the Web Parts related to the lists associated with a specified document.

The **List Web Parts Result Set** is defined using T-SQL syntax, as follows.

| | |
|-----------------------|-------------------|
| tp_ListID | uniqueidentifier, |
| tp_Type | tinyint, |
| tp_Id | uniqueidentifier, |
| tp_Flags | int, |
| tp_DisplayName | nvarchar(255), |
| tp_PageUrl | nvarchar(255), |
| tp_BaseViewId | tinyint, |
| tp_View | varbinary(max), |
| tp_Level | tinyint, |
| tp_ContentTypeId | varbinary(512), |
| tp_PageUrlID | uniqueidentifier, |
| tp_AllUsersProperties | varbinary(max), |
| tp_PerUserProperties | varbinary(max), |
| tp_WebPartIdProperty | nvarchar(255), |

tp_Cache varbinary(max)

tp_ListID: The list identifier of the list containing the Web Part.

tp_Type: The **Page Type** (section [2.2.1.2.14](#)) of the Web Part.

tp_Id: The **Web Part Identifier** (section [2.2.1.1.15](#)) of the Web Part.

tp_Flags: A **View Flags** (section [2.2.2.13](#)) value specifying view-related settings for this Web Part.

tp_DisplayName: The display name specified for the Web Part, if any. This value can be an empty string.

tp_PageUrl: The store-relative form URL to the site that contains this Web Part.

tp_BaseViewId: The **View Identifier** (section [2.2.1.1.14](#)) for the view where this Web Part is used.

tp_View: Contains implementation-specific XML used when processing this Web Part. This data is stored as a **Compressed Structure** (section [2.2.3.8](#)), and is compressed by the algorithm specified in [\[RFC1950\]](#).

tp_Level: A **Publishing Level Type** (section [2.2.2.6](#)) value specifying the publishing status of the Web Part. This value MUST be NULL if the Web Part does not exist.

tp_ContentTypeId: A binary content type identifier value specifying the valid content types that this Web Part can be used to view. If this Web Part is not restricted to a particular content type, this value MUST be zero.

tp_PageUrlID: The document identifier (2) with which the Web Part is associated.

tp_AllUsersProperties: A list of the XML properties which are common for all users of the Web Part. This value can be NULL.

tp_PerUserProperties: A list of the XML properties which are specific to a particular user of the Web Part. This value can be NULL.

tp_WebPartIdProperty: A string which identifies the Web Part within the page.

tp_Cache: The private data that is cached for the Web Part. This value can be NULL.

2.2.4.16 NULL Individual URL Security Result Set

The **NULL Individual URL Security Result Set** indicates that a specified document is not found.

The **NULL Individual URL Security Result Set** MUST return a single row and is defined using T-SQL syntax, as follows.

```
{ListId}                uniqueidentifier = NULL,  
{Acl}                  varbinary(max) = NULL,  
{AnonymousPermMask}   bigint = NULL,  
{IsAttachment}        bit = 0,  
{NeedManageListRight} bit = 0,  
{BaseType}            int = NULL,  
{ExcludedType}        int = NULL,  
{ListFlags}           bigint = NULL,  
{Level}               tinyint = NULL,
```

```

{DraftOwnerId}          int = NULL,
{DocType}               tinyint = NULL,
{bNeedNoThrottle}      bit = NULL,
{ItemCount}            int = NULL,
{DoclibRowId}          int = 0,
{DocFlags}              int = 0;

```

{ListID}: MUST be NULL.

{Acl}: MUST be NULL.

{AnonymousPermMask}: MUST be NULL.

{IsAttachment}: MUST be 0.

{NeedManageListRight}: MUST be 0.

{BaseType}: MUST be NULL.

{ExcludedType}: MUST be NULL.

{ListFlags}: MUST be NULL.

{Level}: MUST be NULL.

{DraftOwnerId}: MUST be NULL.

{DocType}: MUST be NULL.

{bNeedNoThrottle}: MUST be NULL.

{ItemCount}: MUST be NULL.

{DoclibRowId}: MUST be 0.

{DocFlags}: MUST be 0.

2.2.4.17 NULL Unique Permissions Result Set

The **NULL Unique Permissions Result Set** indicates that unique security scopes are not found in the specified location. When returned, the result set MUST contain a single row of data. The **NULL Unique Permissions Result Set** is defined using T-SQL syntax, as follows.

```

{ScopeId}              binary(1),
{Acl}                  varbinary(max),
{AnonymousPermMask}   binary(1);

```

{ScopeId}: This MUST be 0x00. This field can be cast as a **uniqueidentifier** with a value of 00000000-0000-0000-0000-000000000000.)

{Acl}: This MUST be NULL.

{AnonymousPermMask}: This MUST be 0x00. This field can be cast as a bigint.

2.2.4.18 Object ID Result Set

The **Object ID Result Set** contains the GUID of the matching object, if any. The **Object ID Result Set** is defined using T-SQL syntax, as follows.

```
Id                uniqueidentifier
```

Id: Contains the GUID of the matching object.

2.2.4.19 Principal User Information Result Set

The **Principal User Information Result Set** returns information about a principal. The **Principal User Information Result Set** is defined using T-SQL syntax, as follows.

```
tp_Id                int,
tp_SystemID         varbinary(512),
tp_Title            nvarchar(255),
tp_Login            nvarchar(255),
tp_Email            nvarchar(255),
tp_Notes            nvarchar(1023),
tp_SiteAdmin        bit,
tp_DomainGroup      bit,
tp_Flags            int;
```

tp_Id: The user identifier of the principal. MUST NOT be NULL.

tp_SystemID: The SystemId of the principal. This parameter MUST NOT be NULL.

tp_Title: Contains the display name of the principal. This parameter MUST NOT be NULL.

tp_Login: Contains the login name of the principal. This parameter MUST NOT be NULL.

tp_Email: Contains the e-mail address of the principal. This parameter MUST NOT be NULL.

tp_Notes: Contains notes associated with the principal. This parameter MUST NOT be NULL.

tp_SiteAdmin: Set to 1 if the principal is a **site collection administrator**; otherwise 0. This parameter MUST NOT be NULL.

tp_DomainGroup: Set to 1 if the principal is a domain group; otherwise 0. This parameter MUST NOT be NULL.

tp_Flags: The User Information flags value of the principal. This parameter MUST NOT be NULL.

2.2.4.20 Server Time Result Set

The **Server Time Result Set** returns the current time from the back-end database server in UTC. The **Server Time Result Set** is defined using T-SQL syntax, as follows.

```
{CurrentTime}      datetime;
```

CurrentTime: The current time from the back-end database server, in UTC format.

2.2.4.21 Single Doc Link Information Result Set

The **Link Info Result Set** returns information about each forward link from, and each backward link to, a specified document or document version.

The **Link Info Result Set** MUST be ordered by the **DocId** column and is defined using T-SQL syntax, as follows.

| | |
|---------------|-------------------|
| DocId | uniqueidentifier, |
| LinkDirName | nvarchar(256), |
| LinkLeafName | nvarchar(128), |
| LinkType | tinyint, |
| LinkSecurity | tinyint, |
| LinkDynamic | tinyint, |
| LinkServerRel | bit, |
| LinkStatus | tinyint, |
| PointsToDir | bit, |
| WebPartId | uniqueidentifier, |
| LinkNumber | int, |
| WebId | uniqueidentifier, |
| Search | nvarchar(max), |
| FieldId | uniqueidentifier; |

DocId: The document identifier (2) of the specified document.

LinkDirName: Contains the directory name of the link target.

LinkLeafName: Contains the leaf name of the link target.

LinkType: The **LinkType** value of the link. See **LinkInfo Types** (section [2.2.1.2.10](#)) for a list of valid **LinkType** values. This value MUST be NULL for a backward link.

LinkSecurity: The **LinkSecurity** value of the forward link, which specifies whether the scheme of the link is HTTP or HTTPS. This value MUST be NULL for a backward link.

LinkDynamic: The **LinkDynamic** value of the forward link, which specifies whether the link is to a special type of target. This value MUST be NULL for a backward link.

LinkServerRel: A bit flag which specifies whether the link URL is server-relative or not. A value of one specifies a server-relative URL. This value MUST be NULL for a backward link.

LinkStatus: The **Document Store Type** value (section [2.2.2.4](#)) of the document targeted by a forward link. This value MUST be 128 for a backward link. If the forward link target is a document that does not exist, or if this link refers to a target that exists outside the specified site collection, or if this link refers to a location that could not be verified, this value MUST be NULL.

PointsToDir: A bit flag specifying whether the target of the forward link was a directory and has been modified to target a welcome page. This value MUST be NULL for a backward link. For a forward link, if the link target is a directory where a welcome page is specified, the link MUST be changed to the URL of the welcome page and **PointsToDir** MUST be set to one so that the link can be distinguished from an explicit link to the welcome page; otherwise, this value MUST be zero.

WebPartId: This value MUST be NULL.

LinkNumber: This value MUST be NULL.

WebId: This value MUST be NULL.

Search: This value MUST be NULL.

FieldId: This value MUST be NULL.

2.2.4.22 Site Audit Mask Result Set

The **Site Audit Mask Result Set** contains the context-sensitive identifier for a specified object, and the **Audit Flags** set and inherited on that object. The **Site Audit Mask Result Set** is defined using T-SQL syntax, as follows.

```
{Id}                uniqueidentifier,  
{AuditFlags}       int,  
{InheritAuditFlags} int,  
{SiteGlobalAuditMask} int;
```

{Id}: The identifier for the object. The **Audit Item Type** of the object determines the type of identifier used for this value (for example, a Site Identifier or a List Identifier). If an object of the specified **Audit Item Type** at the specified location is found, the value MUST NOT be NULL; otherwise, it MUST be NULL.

{AuditFlags}: An **Audit Flags** value specifying the operations to be audited that are set directly on the specified object. If an object of the specified **Audit Item Type** at the specified location is not found, the value MUST be NULL.

{InheritAuditFlags}: An **Audit Flags** value specifying the operations to be audited on the specified object that are inherited from a contained document. If an object of the specified **Audit Item Type** at the specified location is not found, the value MUST be NULL.

{SiteGlobalAuditMask}: An **Audit Flags** value specifying the operations to be audited on the specified object that are applied globally within the specified site collection.

2.2.4.23 Site Feature List Result Set

The **Site Feature List Result Set** contains the list of Feature Identifiers of a site.

The **Site Feature List Result Set** is defined using T-SQL syntax, as follows.

```
FeatureId uniqueidentifier;
```

FeatureId: A Feature Identifier for a feature of a site.

2.2.4.24 Site Metadata Result Set

The **Site Metadata Result Set** contains metadata for a site or sites.

The **Site Metadata Result Set** is defined using T-SQL syntax, as follows.

```
Id                uniqueidentifier,  
Title             nvarchar(255),  
Description       nvarchar(max),  
MetaInfoVersion  int,  
WebTemplate       int,  
Language         int,  
Locale           int,
```

| | |
|-----------------------------|-------------------|
| Collation | smallint, |
| TimeZone | smallint, |
| Time24 | bit, |
| CalendarType | smallint, |
| AdjustHijriDays | smallint, |
| AltCalendarType | tinyint, |
| CalendarViewOptions | tinyint, |
| WorkDays | smallint, |
| WorkDayStartHour | smallint, |
| WorkDayEndHour | smallint, |
| ProvisionConfig | smallint, |
| Flags | int, |
| Author | int, |
| AlternateCSSUrl | nvarchar(260), |
| CustomizedCss | nvarchar(260), |
| CustomJSUrl | nvarchar(260), |
| AlternateHeaderUrl | nvarchar(260), |
| SecurityProvider | uniqueidentifier, |
| MasterUrl | nvarchar(260), |
| CustomMasterUrl | nvarchar(260), |
| {SiteLogoUrl} | nvarchar(260), |
| {SiteLogoDescription} | nvarchar(255), |
| AllowMUI | bit, |
| TitleResources | nvarchar(256), |
| DescriptionResource | nvarchar(256), |
| AlternateMUICultures | nvarchar(max), |
| OverwriteMUICultures | bit, |
| UIVersion | tinyint, |
| ClientTag | smallint, |
| AnonymousPermMask | bigint, |
| {SiteFlags} | int, |
| {SitePortalURL} | nvarchar(260), |
| {SitePortalName} | nvarchar(255), |
| MeetingCount | smallint, |
| DefTheme | nvarchar(64), |
| CachedNav | varbinary(max), |
| CachedInheritedNav | varbinary(max), |
| CachedNavDirty | int, |
| CachedDataVersion | int, |
| NavParentWebId | uniqueidentifier, |
| FirstUniqueAncestorWebId | uniqueidentifier, |
| ScopeId | uniqueidentifier, |
| DbNow | datetime, |
| Acl | varbinary(max), |
| {RequestAccessEmail} | nvarchar(255), |
| Ancestry | varbinary(max), |
| ProductVersion | smallint, |
| tp_Id | int, |
| tp_SiteAdmin | bit, |
| tp_IsActive | bit, |
| tp_Login | nvarchar(255), |
| tp_Email | nvarchar(255), |
| tp_Title | nvarchar(255), |
| tp_Notes | nvarchar(1023), |
| tp_ExternalTokenLastUpdated | datetime, |
| tp_Token | varbinary(max), |
| tp_Flags | int, |
| UserId | int, |
| {SiteSecurityVersion} | bigint, |

| | |
|--------------------------|-------------------|
| tp_Locale | int, |
| tp_TimeZone | smallint, |
| tp_Time24 | bit, |
| tp_CalendarType | smallint, |
| tp_AdjustHijriDays | smallint, |
| tp_AltCalendarType | tinyint, |
| tp_CalendarViewOptions | tinyint, |
| tp_WorkDays | smallint, |
| tp_WorkDayStartHour | smallint, |
| tp_WorkDayEndHour | smallint, |
| tp_MUILanguages | varchar(64), |
| tp_ContentLanguages | varchar(64), |
| {SiteHashKey} | binary(16), |
| {UserInfoListId} | uniqueidentifier, |
| {RootWebId} | uniqueidentifier, |
| {SiteLastContentChange} | datetime, |
| {SiteLastSecurityChange} | datetime, |
| {RbsCollectionId} | int, |
| {DenyPermMask} | tPermMask; |

Id: The Site Identifier for the site.

Title: The title of the site for display in the front-end Web server.

Description: The description of the site for display in the front-end Web server.

MetaInfoVersion: A counter incremented any time a change is made to the MetaInfo for this site and used for internal conflict detection.

WebTemplate: The identifier for the site template used in the **site definition** to define the base structure of this site.

Language: The LCID associated with the site which is used to determine current UI culture, which determines which language resources to use to display messages on the front-end Web server.

Locale: The LCID associated with the site which is used to determine the current culture for regional language specific data formatting such as currency or date and time settings.

Collation: The Collation Order of the site which indicates an additional sorting order that is processed by the back-end database server. The collation method is an implementation-specific capability of the front-end Web server and back-end database server.

TimeZone: The Time Zone Identifier for the time zone to be used when displaying time values for this site.

Time24: If set to "1", use a 24-hour time format when displaying time values for this site; otherwise, a 12-hour time format can be used.

CalendarType: The **Calendar Type** that is to be used when processing date values for this site.

AdjustHijriDays: If the **Calendar Type** value is "6", this specifies the number of days to extend or reduce the current month in Hijri calendars for this site.

AltCalendarType: The **Calendar Type** of an alternate calendar for processing date values for this site. If NULL, only the **CalendarType** value is used for this site.

CalendarViewOptions: A **Calendar View Options Type** that specifies the calendar display options setting for this site.

WorkDays: A set of **Workdays Flags** that specify the weekdays defined as the workweek for this site.

WorkDayStartHour: The start time of the workday in minutes after midnight for this site.

WorkDayEndHour: The end time of the workday in minutes after midnight for this site.

ProvisionConfig: An identifier of the site template used to provision this site. The following reserved site template identifiers are defined.

| Value | Description |
|-------|--|
| -1 | This site has not had any site template provisioned. |
| 0 | This site has the implementation-specific default site template applied. |
| 1 | This site has the Team Collaboration site template applied. |
| 2 | This site has the Meeting Workspace site template applied. |
| 3 | This site has the Central Administration site template applied. |
| 4 | This site has the Wiki site template applied. |
| 9 | This site has the Blog site template applied. |

Flags: A **Site Property Flags** value describing the configuration of this site.

Author: The User Identifier of the user who is listed as creating this site.

AlternateCSSUrl: The URL for a custom CSS sheet file registered on the site for use in pages of the site.

CustomizedCss: This contains an implementation-specific list of custom CSS files associated with this site.

CustomJSUrl: The URL for a custom JavaScript file registered on the site for use in pages of the site.

AlternateHeaderUrl: The URL for a custom header HTML page registered on the site for use in pages of the site when rendered on the front-end Web server.

SecurityProvider: COM **class identifier (CLSID)** of the **external security provider** for this site. This is NULL for sites using the native security implementation.

MasterUrl: The URL for the master page registered on the site for use in pages of the site when rendered on the front-end Web server.

CustomMasterUrl: The URL for an alternate master page registered on the site for use in pages of the site rendered on the front-end Web server.

{SiteLogoUrl}: The URL of an image that represents the site for display in the front-end Web server.

{SiteLogoDescription}: The description of the image that represents the site for display in the front-end Web server as an ALT tag on the image.

@AllowMUI: A bit which indicates whether the Multilingual User Interface feature is enabled.

@TitleResource: The resource token or resource identifier of the title for the site whose metadata is to be updated.

@DescriptionResource: The resource token or resource identifier of the description for the site whose metadata is to be updated.

@AlternateMUIcultures: The string that contains the distinct language identifier(s) for all the alternate language(s) of the site. For example, the language identifier for English is 1033. Every element is separated by semicolon from the next.

@OverwriteMUIcultures: A bit which specifies whether the changes made to user-specified text in the default language automatically overwrite the existing translations made in all alternate languages.

@UIVersion: A number that represents the visual state of the site.

@ClientTag: A number that represents the state of the application files of the site.

AnonymousPermMask: A **WSS Rights Mask** that indicates the permissions granted to a user that is anonymous, or has no specific permissions, to this site. The value **MUST** be NULL for sites that do not exist.

{SiteFlags}: A **Site Collection Flags** value that indicates the settings for the site collection that contains this site.

{SitePortalURL}: The URL for a different site registered on the site for use in **navigation structures** as a parent location.

{SitePortalName}: The display name of a different site registered on the site for use in navigation structures as a parent location.

MeetingCount: If this site is a meeting workspace (that is, its site template identifier in **ProvisionConfig** is set to 2), this value indicates the number of meetings that are configured.

DefTheme: The name of a theme that is used as part of the display of the site.

CachedNav: An implementation-specific serialization of navigation structure information to display in front-end Web server elements associated with this site.

CachedInheritedNav: This contains an implementation-specific serialization of navigation structure information to display in front-end Web server elements associated with the root navigation elements for this site.

CachedNavDirty: If this value is not set to "0", the cached navigation information for this site **MUST** be regenerated.

CachedDataVersion: A counter incremented on every change to the cached navigation information, used for internal conflict detection.

NavParentWebId: The Site Identifier of the site to be treated as the parent of this site when displaying navigation elements in the front-end Web server.

FirstUniqueAncestorWebId: The Site Identifier of the closest site in this site's ancestor chain that does not inherit security settings from its **parent site**.

ScopeId: The Scope Identifier of the security scope containing the site.

DbNow: The current time in UTC format on the back-end database server.

Acl: The binary serialization of the WSS ACL Format ACL for this site. This is either explicitly defined or inherited from the parent object of the site.

{RequestAccessEmail}: The e-mail address for a user who has the authority to grant access to the site, if any. This can be used by the front-end Web server to generate an e-mail to request access for a user who does not have access to the site.

Ancestry: An implementation-specific serialization of the navigation structure information for the site.

ProductVersion: The implementation-specific version identifier used to create the site.

tp_Id: The User Identifier of the current user.

tp_SiteAdmin: Set to "1" if the current user is an administrator of the site.

tp_IsActive: Set to "1" if the current user is an active user in the site collection containing this site.

tp_Login: The login information of the current user.

tp_Email: The e-mail address of the current user.

tp_Title: The display name of the current user.

tp_Notes: Notes about the current user.

tp_ExternalTokenLastUpdated: A time stamp in UTC format specifying the time when the **External Group Token** for the current user was last updated.

tp_Flags: A **WSS User Flags** value of the specified user

tp_Token: A WSS User Token value specifying the site group membership of the current user.

UserId: The site membership identifier of the current user. This is NULL if the current user has not been added to the set of members of this site.

{SiteSecurityVersion}: The current security information version of the site collection.

tp_Locale: An LCID referring to the locale value to be used when displaying messages in the front-end Web server for the current user. If this value is NULL, the site setting for **Locale** is used instead.

tp_TimeZone: The Time Zone Identifier for the time zone to be used when displaying time values for the current user. If this value is NULL, the site setting for **TimeZone** is used instead.

tp_Time24: A bit flag which specifies whether to use a 24-hour time format when displaying time values to the current user. If this parameter is set to "1", the 24-hour time format is be used; otherwise, the 12-hour time format is be used. If this value is NULL, the site setting for **Time24** MUST be used instead.

tp_CalendarType: The **Calendar Type** to be used when processing date values for the current user. If this value is NULL, the site setting for **CalendarType** MUST be used instead.

tp_AdjustHijriDays: If the **tp_CalendarType** value is "6", this specifies the number of days to extend or reduce the current month in Hijri calendars for the current user. If this value is NULL, the site setting for **AdjustHijriDays** MUST be used instead.

tp_AltCalendarType: The Calendar Type of an alternate calendar to be used when displaying calendars in views for the current user. If this value is NULL, the site setting for **AltCalendarType** MUST be used instead.

tp_CalendarViewOptions: A Calendar View Options Type specifying the calendar options for the current user. If this value is NULL, the site setting for **CalendarViewOptions** MUST be used instead.

tp_WorkDays: A set of Workdays Flags specifying the weekdays defined as the workweek for the current user. If this value is NULL, the site setting for **WorkDays** MUST be used instead.

tp_WorkDayStartHour: The start time of the work day in minutes after midnight for the current user. If this value is NULL, the site setting for **WorkDayStartHour** MUST be used instead.

tp_WorkDayEndHour: The end time of the workday in minutes after midnight for the current user. If this value is NULL, the site setting for **WorkDayEndHour** MUST be used instead.

tp_MUILanguages: A string that contains the distinct culture(s) for the user's preferred display language(s), separated by semicolon. This string can be NULL.

tp_ContentLanguages: A string that contains the distinct culture(s) for the user's preferred content language(s), separated by semicolon. This string can be NULL.

{SiteHashKey}: Contains binary information used when generating digital signatures of information associated with this site collection.

{UserInfoListId}: The list identifier of the user information list for the site collection containing this site.

{RootWebId}: The site identifier for the root site of the site collection containing this site.

{SiteLastContentChange}: A time stamp in UTC format describing the time content was last changed within this site collection.

{SiteLastSecurityChange}: A time stamp in UTC format describing the time security settings were last changed within this site collection.

{RbsCollectionId}: The identifier for the remote BLOB storage collection for the site collection, or zero if remote BLOB storage is not configured for this database.

{DenyPermMask}: A **WSS Rights Mask** (section [2.2.2.15](#)) specifying the rights to deny to the current user.

2.2.4.25 Site MetaInfo Result Set

The **Site MetaInfo Result Set** returns metainfo about a site.

The **Site MetaInfo Result Set** is defined using T-SQL syntax, as follows.

```
MetaInfo          varbinary(max);
```

MetaInfo: Site MetaInfo in the form of a metadict. This value can be NULL. The metadict format is specified in the [\[MS-FPSE\]](#) metadict section.

2.2.4.26 Unique Permissions Result Set

The **Unique Permissions Result Set** returns the ACL information for all the unique security scopes of folders and list items contained in a specified location.

The **Unique Permissions Result Set** is defined using T-SQL syntax, as follows.

```
ScopeId          uniqueidentifier,  
Acl              varbinary(max),  
AnonymousPermMask  bigint;
```

ScopeId: The Scope Identifier of the security scope.

Acl: The binary serialization of the WSS ACL Format ACL of the security scope.

AnonymousPermMask: A **WSS Rights Mask** that indicates the permissions granted to an anonymous user, or a user who has no specific permissions on this security scope.

2.2.4.27 URL Result Set

The **URL Result Set** returns a list of URLs, one for the root folder of each site. The **URL Result Set** is defined using T-SQL syntax as follows.

```
FullUrl          nvarchar (256)
```

FullUrl: The store-relative form URL of the site.

2.2.4.28 List Related Fields Result Set

The **List Related fields Result Set** returns information about all the relationship lookup fields (2) whose target list is the specified list. The T-SQL syntax for this result set is as follows:

```
tp_WebId        uniqueidentifier NOT NULL,  
tp_Id           uniqueidentifier NOT NULL,  
FieldId         uniqueidentifier NOT NULL,  
DeleteBehavior  tinyint NOT NULL
```

tp_WebId: The site identifier of the site which contains the relationship lookup field (2).

tp_Id: The list identifier of the list which contains the relationship lookup field (2).

FieldId: The **field identifier** of the relationship lookup field (2).

DeleteBehavior: The relationship delete behavior on the relationship lookup field (2)

2.2.4.29 App Principal Information Result Set

The **App Principal Information Result Set** returns information about an **app principal**.

If the **App Principal Info Result Set** is returned, it MUST return one row, as defined using the T-SQL syntax below:

```
{AppPrincipalName}          nvarchar(256),
{ReturnAppPrincipalInfo}    bit,
{WebTemplateId}             int,
{WebTemplateConfigurationId} int
```

{AppPrincipalName}: The app principal identifier.

{ReturnAppPrincipalInfo}: This value MUST be 1.

{WebTemplateId}: The identifier for the site template used in the site definition associated with the stored procedure.

{WebTemplateConfigurationId}: The value as defined by **ProvisionConfig** in section [2.2.4.24](#).

2.2.4.30 App Principal Permissions Result Set

The **App Principal Permissions Result Set** is returned to indicate what permissions the specified app principal has.

If the **App Principal Permissions Result Set** is returned, it MUST return at least one row, as defined using the T-SQL syntax below:

```
{Id}          int,
{Name}        nvarchar(256),
{Title}       nvarchar(256),
{Flag}        int,
{WebId}       uniqueidentifier,
{ListId}      uniqueidentifier,
{Perm}        int
```

{Id}: The app principal integer identifier in the site collection.

{Name}: The app principal identifier.

{Title}: The title of the app principal.

{Flag}: The app principal flag that specifies the state of the app principal. All valid values for this flag are specified in the following table.

| Value | Description |
|-------|---|
| 0 | No flags. |
| 1 | The app principal has been disabled. |
| 2 | The app principal has no tenant scoped permissions. |
| 4 | Allow App Only Policy. |

{WebId}: The site identifier of the site containing the document.

{ListId}: The list identifier of the list containing the document.

{Perm}: The permission value as defined in section [2.2.1.2.18](#).

2.2.5 SQL Structures

2.2.5.1 Configuration Object

A Configuration Object encapsulates as a group of application settings a set of metadata used to identify and manipulate those settings. Configuration Objects have the following fields.

2.2.5.1.1 Class

Applications use a Configuration Object **Class** to help distinguish the schemas of the data stored in different objects. **Class** is a complex data type with the following fields, defined in T-SQL syntax.

```
ClassId                uniqueidentifier NOT NULL,  
BaseClassId           uniqueidentifier NOT NULL,  
FullName              nvarchar(256)    NOT NULL
```

ClassId: This MUST be a GUID that is different from all other **ClassIds** registered in the Configuration Database.

BaseClassId: A class is said to derive from the class referenced by **BaseClassId**. This allows a class hierarchy to be built. Many **ClassIds** can share a single **BaseClassId**. The **BaseClassId** of a Configuration Object Class MUST have the same value as a **ClassId** in the Configuration Database. If a Configuration Object Class has no base class, its **BaseClassId** MUST be identical to its **ClassId**.

FullName: An identifier that can be used by an application to associate a **ClassId** with a human-readable or machine-readable string.

The following classes are used during the execution of this protocol.

| Class | ClassId |
|---------------------------|--------------------------------------|
| Alternate URL Collection | 9920F486-2FF4-4d10-9532-E01979826585 |
| Content Database | 3D4F5451-1735-48bb-B920-76C1EC240B1D |
| Database Service Instance | 3112E92F-B97D-481e-8CEB-03FDE15ED1A7 |
| Farm | 674DA553-EA77-44A3-B9F8-3F70D786DE6A |
| Server | E77AAF47-3CAC-4001-BC6B-5BCCB6486318 |
| Web Application | 113FB569-7520-4651-8FC4-E9F4F5887618 |
| Web Service | 45AD2BF2-4E3E-46A1-B477-126944C0ACEF |

2.2.5.1.2 Id

A Configuration Object's **Id** is used to identify a single instance of a Configuration Object. As such, it MUST be different from the IDs of all other Configuration Objects in the Configuration Database. **Id** is defined in T-SQL format as follows.

Id uniqueidentifier NOT NULL

2.2.5.1.3 Name

Configuration Objects can also be identified by name. Unlike **Id**, a Configuration Object's name is only used to distinguish instances of Configuration Objects with the same parent and class. The combination of name, parent, and class **MUST** be unique among the set of Configuration Objects in a single Configuration Database. **Name** is defined in T-SQL format as follows.

Name nvarchar(128) NOT NULL

2.2.5.1.4 Parent

Configuration Objects are organized in an ancestry hierarchy. Each Configuration Object **MUST** have one and only one parent, which **MUST** be a Configuration Object registered in the same Configuration Database. The set of Configuration Objects with a given parent are known as the parent's children. A Configuration Object's descendants are the set of Configuration Objects including the parent's children, the children's children, and so on.

The Configuration Object at the root of an ancestry hierarchy **MUST** be its own parent.

The Configuration Database **MUST** delete a Configuration Object when its parent is deleted.

A Configuration Object defines its parent through its own **ParentId** property, which is the **Id** of its parent. **ParentId** is defined in T-SQL format as follows.

ParentId uniqueidentifier NOT NULL

2.2.5.1.5 Status

The **Status** property of a Configuration Object **MUST** conform to the data type defined in the Configuration Object **Status** section.

Status int NOT NULL

2.2.5.1.6 Version

Version is used to identify when a Configuration Object has been created, modified, or deleted. **Version** is defined in T-SQL format as follows.

Version rowversion NOT NULL

2.2.5.1.7 Properties

Any configuration settings needed by an application that are not stored in one of the other Configuration Object field can be stored in the **Properties** field, which is defined using T-SQL format as follows.

Properties nvarchar(max)

Successful execution requires parsing the properties of the following classes. Each of these classes stores its properties in an XML format. Because only a portion of each class' **Properties** field is needed for successful execution, the values needed are identified using queries from the XML Path Language specified in [\[XPATH\]](#). The schemata of the contents of other Configuration Objects' **Property Bags** will differ based on the needs of each application and are not specified in this document. Unless otherwise noted in the description column, each XPath query resolves to one and only one element value.

2.2.5.1.7.1 Alternate URL Collection

An **Alternate URL Collection** Configuration Object stores a list of absolute URLs. The parent of an **Alternate URL Collection** MUST be a Farm Configuration Object.

| Property | XPath Query | Description |
|----------------------|--|--|
| Alternate URL | /object/flid[attribute::name='m_Urls']/flid/object/sflid[attribute::name='m_RequestUri'] | When executed against the properties of an Alternate URL Collection Configuration Object, this query MUST return one or more values containing absolute URLs. The URLs MUST contain only the portion of the incoming URL beginning with the scheme component and ending with the Authority Component (for example, "http://example.com:80"). The URLs MUST be unique within a Configuration Database. |

2.2.5.1.7.2 Content Database

The **Content Database** Configuration Object stores information needed to establish a connection to a content database.

| Property | XPath Query | Description |
|-----------------|--|---|
| Username | /object/flid[attribute::name='m_Username'] | If the value returned by this XPath query is not NULL or empty, the client uses SQL authentication to connect to the content database. The client MUST pass the value returned by the XPath query as the SQL authentication username. |
| Password | /object/flid[attribute::name='m_Password'] | If the value returned by this XPath query is not NULL or empty, the client MUST include this value in the user name portion of the content database connection string. |

2.2.5.1.7.3 Web Application

The **Web Application** Configuration Object stores a list of content databases used by the **Web application (1)** as well as information needed to parse URLs. The parent of a **Web Application** Configuration Object MUST be a **Web Service** Configuration Object.

| Property | XPath Query | Description |
|---|--|---|
| Web Application Alternate URL Collection | /object/fld[attribute::name='m_AlternateUrlCollection'] | This value is a string representation of a Configuration Object ID . It is used to associate a Web application (1) with an Alternate URL Collection . Each Alternate URL Collection MUST be referenced by zero or one Web applications (1). |
| Prefix Name | /object/fld[attribute::name='m_Prefixes']/object/fld/fld/object/sFld[attribute::name='m_Name'] | The value returned by this query MUST be a valid URL Path segment. |
| Prefix Type | /object/fld[attribute::name='m_Prefixes']/object/fld/fld/object/sFld[attribute::name='m_Type'] | The value returned by this query MUST be the literal ExplicitInclusion or the literal WildcardInclusion . ExplicitInclusion specifies that a path-based site collection can be created under the specified URL path. WildcardInclusion specifies that multiple path-based site collections can be created under the specified URL path. |

2.2.5.2 Dependencies

In addition to the ancestry hierarchy defined in **Parent** (section [2.2.5.1.4](#)), Configuration Objects can also define **Dependencies**. **Dependencies** can be used by an application to discover the list of Configuration Objects that depend on a given Configuration Object.

A **Dependency** is a complex type with the following fields, defined in T-SQL format as follows.

```
ObjectId                uniqueidentifier NOT NULL
DependantId             uniqueidentifier NOT NULL
```

ObjectId: The **ID** of the Configuration Object that depends on another.

DependantId: The **ID** of the Configuration Object upon which the Configuration Object identified by **ObjectId** depends.

2.2.6 Tables and Views

2.2.6.1 AllDocs Table

The **AllDocs** table stores data for all documents in the content database.

The **AllDocs** table is defined using T-SQL syntax as follows.

```
TABLE AllDocs (
    Id                uniqueidentifier NOT NULL,
    SiteId            uniqueidentifier NOT NULL,
    DirName           nvarchar(256)    NOT NULL,
    LeafName          nvarchar(128)   NOT NULL,
    WebId             uniqueidentifier NOT NULL,
    ListId            uniqueidentifier NULL,
    DoclibRowId       int              NULL,
    Type              tinyint          NOT NULL,
    SortBehavior      tinyint          NOT NULL DEFAULT 0,
    Size              int              NULL,
    ETagVersion       AS
        CASE
            WHEN InternalVersion IS NULL
            THEN NULL
            ELSE ((InternalVersion + (BumpVersion * 256)) / 256)
        END,
    EffectiveVersion  AS
        CASE
            WHEN InternalVersion IS NULL
            THEN NULL
            ELSE InternalVersion + (BumpVersion * 256)
        END,
    InternalVersion   int              NULL,
    BumpVersion       tinyint          NOT NULL DEFAULT 0,
    UIVersion         int              NOT NULL DEFAULT 512,
    Dirty AS CASE WHEN BumpVersion <> 0 THEN CAST(1 as bit) ELSE CAST(0 as bit) END,
    ListDataDirty     bit              NOT NULL DEFAULT 0,
    DocFlags          int              NULL,
    ThicketFlag       bit              NULL DEFAULT 0,
    CharSet           int              NULL,
    ProgId            nvarchar(255)    NULL,
```

```

TimeCreated                datetime           NOT NULL,
TimeLastModified          datetime           NOT NULL,
NextToLastTimeModified    datetime           NULL,
MetaInfoTimeLastModified  datetime           NULL,
TimeLastWritten            datetime           NULL,
DeleteTransactionId        varbinary(16)     NOT NULL DEFAULT 0x,
SetupPathVersion           tinyint           NOT NULL DEFAULT 4,
SetupPath                  nvarchar(255)    NULL,
SetupPathUser              nvarchar(255)    NULL,
CheckoutUserId             int               NULL,
CheckoutDate               datetime           NULL,
CheckoutExpires            datetime           NULL,
VersionCreatedSinceSTCheckout bit               NOT NULL DEFAULT 0,
LTCheckoutUserId          AS
    CASE WHEN DocFlags & 32 = 32
    THEN CheckoutUserId
    ELSE NULL
    END,
VirusVendorID             int               NULL,
VirusStatus               int               NULL,
VirusInfo                  nvarchar(255)    NULL,
VirusInfoEx,              varbinary(max)   NULL,
MetaInfo                   varbinary(max)   NULL,
MetaInfoSize              int               NULL,
MetaInfoVersion           int               NOT NULL DEFAULT 1,
UnVersionedMetaInfo       varbinary(max)   NULL,
UnVersionedMetaInfoSize   int               NULL,
UnVersionedMetaInfoVersion int               NULL,
WelcomePageUrl            nvarchar(260)    NULL,
WelcomePageParameters     nvarchar(max)    NULL,
IsCurrentVersion          bit               NOT NULL DEFAULT 1,
Level                     tinyint           NOT NULL DEFAULT 1,
CheckinComment            nvarchar(1023)   NULL,
AuditFlags                int               NULL,
InheritAuditFlags         int               NULL,
DraftOwnerId              int               NULL,
UIVersionString           AS
    CAST(UIVersion/512 AS nvarchar) + '.' + CAST(UIVersion%512 AS nvarchar),
ParentId                  uniqueidentifier NOT NULL,
HasStream                 AS
    WHEN Type = 0 AND
    ((DocFlags & 256) = 256) AND
    SetupPath IS NULL OR (SetupPath IS NOT NULL AND
    ((DocFlags & 64) = 64))
    THEN 1
    ELSE 0
    END,
ScopeId                   uniqueidentifier NOT NULL,
BuildDependencySet        varbinary(max)   NULL,
ParentVersion             int               NULL,
ParentVersionString       AS
    CAST(ParentVersion/512 AS nvarchar) + '.' +
    CAST(ParentVersion%512 AS nvarchar),
TransformerId             uniqueidentifier NULL,
ParentLeafName            nvarchar(128)    NULL,
IsCheckoutToLocal         AS
    CASE
    WHEN DocFlags & 512 = 512
    THEN 1

```

```

        ELSE 0
    END,
    CtoOffset                smallint                NULL,
    Extension                AS
    CASE
        WHEN
            CHARINDEX(N'.', LeafName COLLATE Latin1_General_BIN) > 0
            THEN RIGHT(LeafName,
                CHARINDEX(N'.', REVERSE(LeafName)
                    COLLATE Latin1_General_BIN)-1)
        ELSE N''
    END,
    ExtensionForFile        AS
    CASE
        WHEN Type = 0 AND
            CHARINDEX(N'.', LeafName COLLATE Latin1_General_BIN) > 0
            THEN RIGHT(LeafName,
                CHARINDEX(N'.', REVERSE(LeafName)
                    COLLATE Latin1_General_BIN)-1)
        ELSE N''
    END,
    ItemChildCount          int                    NOT NULL DEFAULT 0,
    FolderChildCount        int                    NOT NULL DEFAULT 0,
    FileFormatMetaInfo      varbinary(max)        NULL,
    FileFormatMetaInfoSize  int                    NOT NULL DEFAULT 0,
    FFMConsistent           bit                    NULL,
    ContentVersion          int                    NOT NULL DEFAULT 0,
    ListSchemaVersion       int                    NULL,
    ClientId                varbinary(16)         NULL,
    NextBSN                 bigint                NULL,
    StreamSchema            tinyint                NULL);

```

Id: The document identifier (2) of the document.

SiteId: The **Site Collection Identifier** (section [2.2.1.1.9](#)) of the site collection containing the document.

DirName: The directory name of the document location.

LeafName: The leaf name of the document location.

WebId: The **Site Identifier** (section [2.2.1.1.11](#)) of the site containing the document.

ListId: The **List Identifier** (section [2.2.1.1.5](#)) of the list containing the document, if any, or NULL if the document is not contained in a list.

DoclibRowId: The row identifier for the document within the containing document library or list, if applicable.

Type: An integer identifier specifying the document's **Document Store Type** (section [2.2.2.4](#)).

SortBehavior: An integer value specifying how an item is sorted within a view. If this parameter is set to one, the item MUST be sorted like a folder. If this parameter is set to zero, it MUST be sorted like a file. If the document is a site, the value MUST be two. If this parameter is set to three, it MUST be sorted like a folder or a site. If this parameter is set to 128, it MUST be sorted like a backward link. Other values are invalid. [<3>](#)

Size: The size of the document stream in bytes. This parameter can be set to NULL or to zero for items such as sites, folders, document libraries, and lists.

ETagVersion: A counter used for conflict detection that is incremented any time a change is made to this document. This takes into account the pending version update in **BumpVersion**. This is a version number separate from the user-visible versioning system in **UIVersion** and **UIVersionString**.

EffectiveVersion: A counter incremented any time a change is made to the document and is only used internally. This takes into account the pending version update in **BumpVersion**.

InternalVersion: A counter incremented any time a change is made to the document and is only used internally to join to other tables. This does not take into account the pending version update in **BumpVersion**.

BumpVersion: A counter incremented any time the **InternalVersion** of a document needs to be updated. It stores the pending version update to the document.

UIVersion: A UI version number associated with the document. **UIVersion** defaults to 512, which corresponds to a displayed version of 1.0.

Dirty: Set to one if the document has dependencies that require further processing.

ListDataDirty: Set to one if the document requires subsequent fix-up of link information.

CacheParseId: An implementation-specific identifier for an internal dependency update process. Used to manage bulk updates to documents when processed for dependency fix-up.

DocFlags: A **Doc Flags** value (section [2.2.2.3](#)) specifying information about the document. See the **Doc Flags** section for details.

ThicketFlag: If set to one, this indicates that the document is an auxiliary thicket file, one of a set of files supporting a thicket.

CharSet: An optional **character set (2)** associated with the document. Any **Windows code page** identifier is valid for **CharSet**. This value can be NULL, indicating that no Windows code page is specified for the document.

ProgId: An optional preferred application to open this document. The **ProgId** is used to distinguish between different applications that save files with a given file extension (that is, different editors for HTML or XML files).

TimeCreated: A time stamp in UTC format specifying when this document was created.

TimeLastModified: A time stamp in UTC format. The value specifies when the document was last saved. This corresponds to the actual time when the document was last modified.

NextToLastTimeModified: The value of **TimeLastModified** from the previous time that the document was saved.

MetaInfoTimeLastModified: A time stamp in UTC format specifying when the metadata information for the document was last changed.

TimeLastWritten: A time stamp in UTC format specifying when any changes were made to the document stream. This does not reflect changes made strictly to the **MetaInfo** or other item properties.

DeleteTransactionId: The transaction identifier for the implementation-specific deleted items recycle bin. A value of 0x specifies that this document is not marked as deleted. In the **Docs View** (section [2.2.6.3](#)), **DeleteTransactionId** MUST equal 0x, because the **Docs View** only displays items that are not marked as deleted.

SetupPathVersion: For an uncustomized document, this parameter governs the **SetupPath** fragment relative to the setup path location. The following values are valid.

| Value | Description |
|-------|---|
| NULL | This is not an uncustomized document. |
| 2 | The SetupPath is relative to the install location of Windows SharePoint Services 2.0 on the front-end Web server (for example, Program Files\Common Files\Microsoft Shared\Web Server Extensions\60). |
| 3 | The SetupPath is relative to the install location of Windows SharePoint Services 3.0 on the front-end Web server (for example, Program Files\Common Files\Microsoft Shared\Web Server Extensions\12). |
| 4 | The SetupPath is relative to the install location of Microsoft SharePoint Foundation 2010 on the front-end Web server (for example, Program Files\Common Files\Microsoft Shared\Web Server Extensions\14). |
| 15 | The SetupPath is relative to the install location of Microsoft SharePoint Foundation 2013 on the front-end Web server (for example, Program Files\Common Files\Microsoft Shared\Web Server Extensions\15). |

SetupPath: For a document that is now or once was uncustomized, this contains the setup path fragment relative to the base setup path specified by the **SetupPathVersion** value, where the content stream (1) of this document can be found. This value MUST be NULL if the document was never uncustomized.

SetupPathUser: If this document is now or once was uncustomized, this contains the login name of the user who created the uncustomized document. This value is undefined for documents that were never uncustomized.

CheckoutUserId: If the document is checked out, this parameter contains the **User Identifier** (section [2.2.1.1.13](#)) of the user who has the document checked out. Otherwise, this parameter is NULL.

CheckoutDate: A time stamp in UTC format indicating when this document was checked out.

CheckoutExpires: A time stamp in UTC format indicating when the short-term lock for this document will expire.

VersionCreatedSinceSTCheckout: If this parameter is one, the document version has been incremented since the document last had a short-term lock established. This is used to prevent more than one new version of the document from being created while a short-term lock is established.

LTCheckoutUserId: If the document is currently checked out, this parameter is a **calculated column** containing the value of **CheckoutUserId**. Otherwise, this parameter is NULL.

VirusVendorID: The identifier of the virus scanner that processed this document. This value MUST be NULL if this document has not been processed by a virus scanner.

VirusStatus: An enumerated type specifying the current virus check status of this document. This value MUST be NULL if the document has not been processed by a virus scanner. See **Virus Status** (section [2.2.1.2.17](#)) for a list of valid values.

VirusInfo: A string containing a provider-specific message returned by the virus scanner when it last processed the document. This value MUST be NULL if the document has not been processed by a virus scanner.

VirusInfoEx: A binary value that specifies extensible virus information for this document, which is opaque to the back-end server.

MetaInfo: A metadict for the document. The metadict format is specified in the [\[MS-FPSE\]](#) section 2.2.2.2.11.

MetaInfoSize: The size, in bytes, of the document metadata info.

MetaInfoVersion: An integer value that tracks the version of the document metadata info.

UnVersionedMetaInfo: A metadict holding all version-independent metadata for the document.

UnVersionedMetaInfoSize: The size in bytes of **UnVersionedMetaInfo**.

UnVersionedMetaInfoVersion: An integer value that tracks the version of the **UnVersionedMetaInfo** metadata.

WelcomePageUrl: If the document is a folder, this optionally specifies a page to redirect to when the folder is requested with an HTTP GET operation. The URL is relative to the URL of the folder itself and MUST be subsumed by that folder. Attempts to break out of the folder, such as "../..default.aspx", are not valid.

WelcomePageParameters: This parameter MUST contain any URL parameters configured for the welcome page. This value contains a query string starting with "?" or a hash parameter starting with "#".

IsCurrentVersion: If this value is set to one, this row is for a current version of the document (out of all the rows corresponding to the given **DirName**, **LeafName**, each with a different **Publishing Level Type** value (section [2.2.2.6](#))). Otherwise, this row is for a historical version of the document.

Level: A **Publishing Level Type** value specifying the publishing level of this version of the document as checked out, draft, or published.

CheckinComment: An optional comment string associated with the document when it was last checked in or published.

AuditFlags: An **Audit Flags** value (section [2.2.2.1](#)) determining the operations to be tracked on this document.

InheritAuditFlags: An **Audit Flags** value determining the operations to be tracked on this document's children.

DraftOwnerId: If the current publishing level of the document is a draft, this is the **User Identifier** (section [2.2.1.1.13](#)) of the user who has that draft version checked out. Otherwise, this MUST be set to NULL.

UIVersionString: A calculated column presenting the value of the **UIVersion** column as a displayed version string, in the following format: major version value, followed by '.', followed by the minor version value. For example, **UIVersion** values 512, 513, 514, and 1024 correspond to **UIVersionString** values of 1.0, 1.1, 1.2, and 2.0, respectively.

ParentId: The document identifier (2) of the document's parent container. For example, the document identifier (2) of the folder or document library containing this subfolder or document. This value MUST NOT be NULL, because every item but one has a parent container. A special empty document identifier (2), '00000000-0000-0000-0000-000000000000', marks the parent container of the topmost item (the root site) in the site collection.

HasStream: A calculated bit indicating whether the document has an associated document stream. This MUST be set to "1" if:

- The **SetupPath** is NULL and the document's **Document Store Type** is zero (file) and it is allowed to contain a stream (1).
- The **SetupPath** is not NULL and the document content is customized (1).

If neither condition applies, the value MUST be "0".

ScopeId: The **Scope Identifier** (section [2.2.1.1.8](#)) of the scope of the document.

BuildDependencySet: A binary array holding implementation-specific information about dependent documents. NULL indicates that there is no information about dependencies. A

BuildDependencySet of size zero indicates a document with no dependencies.

ParentVersion: If the document is a transformed version of another document, this is the **UIVersion** value from the original document. This value MUST be NULL if the document is not the product of a document transformation.

ParentVersionString: A calculated column presenting the value of the **ParentVersion** column as a displayed version string. See **UIVersionString** for displayed version format and examples.

TransformerId: If the document is a transformed version of another document, this MUST be the GUID of the agent that performed the transformation. Otherwise, **TransformerId** MUST be NULL.

ParentLeafName: If the document is a transformed version of another document and the original document is in the same folder as the transformed document, this is the leaf name of the original document. This value MUST be NULL if the document is not the product of a document transformation.

IsCheckoutToLocal: A calculated bit indicating whether the document is checked out to a client's local disk. This parameter MUST be set to "1" if the **DocFlags** bit array includes 512 (long-term check-out to local); otherwise, it MUST be set to "0".

CtoOffset: A content type order offset. This is an implementation-specific value used by list and document library views to allow custom ordering of the menu items under the 'New' button. This value can be NULL.

Extension: A calculated field holding the file extension part, if applicable, from the **LeafName** value. If the **LeafName** value contains a "." character, **Extension** MUST hold the string following the last "."; otherwise, **Extension** MUST be set to the empty string. For example, if the full leaf name is 'document.docx.bac', **Extension** MUST be "bac".

ExtensionForFile: A calculated field holding the file extension part, if applicable, from the **LeafName** value. If the document's **Document Store Type** is set to "0", indicating that it is a file type, **ExtensionForFile** MUST be identical to **Extension**; otherwise, the **ExtensionForFile** value MUST be an empty string.

ItemChildCount: The number of nonfolder children of this document.

FolderChildCount: The number of folder children of this document.

FileFormatMetaInfo: A metadict holding the file format metadata info of this document.

FileFormatMetaInfoSize: The size, in bytes, of the file format metadata info.

FFMConsistent: A bit flag specifying whether the file format metadata info is in a consistent state.

ContentVersion: A counter used for internal conflict detection that is incremented any time a change is made to the binary contents of this document.

ListSchemaVersion: A counter which keeps track of the schema version of the list containing this document for a document that can be parsed.

ClientId: An identifier assigned by an external client to keep track of this document.

NextBSN: The current BLOB sequence number for the document, used for assigning BLOB sequence numbers to stream binary pieces belonging to this document.

StreamSchema: The stream schema of the stream (1) belonging to this document, if it has one indicated by **HasStream**.

2.2.6.2 AllUserData Table

The **AllUserData** table stores data for all list (1) and document library list items. The table provides a fixed number of generic columns in various data types, affording storage for application-defined variable schemas.

A list item can be represented by more than one row in this table, if its list's (1) schema requires more entries of a particular data type than are available in a single row. Application-defined metadata for documents in document libraries also resides in **AllUserData**, and is accessed by means of joins with the **Docs View** (section [2.2.6.3](#)).

The **AllUserData** table is defined using T-SQL syntax, as follows.

```
TABLE AllUserData (
  tp_Id                int                NOT NULL,
  tp_ListId            uniqueidentifier  NOT NULL,
  tp_SiteId            uniqueidentifier  NOT NULL,
  tp_RowOrdinal        tinyint          NOT NULL  DEFAULT ((0)),
  tp_Version           int                NOT NULL,
  tp_Author            int                NULL,
  tp_Editor            int                NULL,
  tp_Modified          datetime          NULL,
  tp_Created           datetime          NULL,
  tp_Ordering          varchar(512)      NULL,
  tp_ThreadIndex       varbinary(512)    NULL,
  tp_HasAttachment     bit               NOT NULL  DEFAULT ((0)),
  tp_ModerationStatus int               NOT NULL  DEFAULT ((0)),
  tp_IsCurrent         bit               NOT NULL  DEFAULT ((1)),
  tp_ItemOrder        float              NULL,
  tp_InstanceID       int                NULL,
  tp_GUID              uniqueidentifier  NOT NULL  DEFAULT (newid()),
  tp_CopySource        nvarchar(260)     NULL  DEFAULT (NULL),
  tp_HasCopyDestinations bit            NULL  DEFAULT ((0)),
  tp_AuditFlags        int                NULL,
  tp_InheritAuditFlags int              NULL,
  tp_Size              int                NOT NULL  DEFAULT ((0)),
```

```

tp_WorkflowVersion          int          NULL,
tp_WorkflowInstanceID     uniqueidentifier  NULL,
tp_ParentId                uniqueidentifier NOT NULL,
tp_DocId                   uniqueidentifier NOT NULL,
tp_DeleteTransactionId     varbinary(16)   NOT NULL   DEFAULT (0x),
tp_ContentTypeId           tContentTypeId  NULL,
tp_Level                   tinyint        NOT NULL   DEFAULT ((1)),
tp_IsCurrentVersion        bit            NOT NULL   DEFAULT (CONVERT
                                     ([bit], (1), 0)),
tp_UIVersion                int          NOT NULL   CONSTRAINT
                                     [AllUserData_DEFAULT_UIVersionDEFAULT((512)),
tp_CalculatedVersion       int          NOT NULL   CONSTRAINT
                                     [AllUserData_DEFAULT_CalculatedVersionDEFAULT((0)),
tp_UIVersionString         AS
                                     ((CONVERT([nvarchar], [tp_UIVersion]/(512), 0)+'.'
                                     + CONVERT([nvarchar], [tp_UIVersion]%(512), 0)),
tp_DraftOwnerId            int          NULL   DEFAULT (NULL),
tp_CheckoutUserId          int          NULL   DEFAULT (NULL),
tp_AppAuthor               int          NULL,
tp_AppEditor               int          NULL,
bit1                       bit          SPARSE NULL,
bit2                       bit          SPARSE NULL,
bit3                       bit          SPARSE NULL,
bit4                       bit          SPARSE NULL,
bit5                       bit          SPARSE NULL,
bit6                       bit          SPARSE NULL,
bit7                       bit          SPARSE NULL,
bit8                       bit          SPARSE NULL,
bit9                       bit          SPARSE NULL,
bit10                      bit          SPARSE NULL,
bit11                      bit          SPARSE NULL,
bit12                      bit          SPARSE NULL,
bit13                      bit          SPARSE NULL,
bit14                      bit          SPARSE NULL,
bit15                      bit          SPARSE NULL,
bit16                      bit          SPARSE NULL,
bit17                      bit          SPARSE NULL,
bit18                      bit          SPARSE NULL,
bit19                      bit          SPARSE NULL,
bit20                      bit          SPARSE NULL,
bit21                      bit          SPARSE NULL,
bit22                      bit          SPARSE NULL,
bit23                      bit          SPARSE NULL,
bit24                      bit          SPARSE NULL,
bit25                      bit          SPARSE NULL,
bit26                      bit          SPARSE NULL,
bit27                      bit          SPARSE NULL,
bit28                      bit          SPARSE NULL,
bit29                      bit          SPARSE NULL,
bit30                      bit          SPARSE NULL,
bit31                      bit          SPARSE NULL,
bit32                      bit          SPARSE NULL,
bit33                      bit          SPARSE NULL,
bit34                      bit          SPARSE NULL,
bit35                      bit          SPARSE NULL,
bit36                      bit          SPARSE NULL,
bit37                      bit          SPARSE NULL,
bit38                      bit          SPARSE NULL,
bit39                      bit          SPARSE NULL,

```

| | | |
|-------|-----|--------------|
| bit40 | bit | SPARSE NULL, |
| bit41 | bit | SPARSE NULL, |
| bit42 | bit | SPARSE NULL, |
| bit43 | bit | SPARSE NULL, |
| bit44 | bit | SPARSE NULL, |
| bit45 | bit | SPARSE NULL, |
| bit46 | bit | SPARSE NULL, |
| bit47 | bit | SPARSE NULL, |
| bit48 | bit | SPARSE NULL, |
| bit49 | bit | SPARSE NULL, |
| bit50 | bit | SPARSE NULL, |
| bit51 | bit | SPARSE NULL, |
| bit52 | bit | SPARSE NULL, |
| bit53 | bit | SPARSE NULL, |
| bit54 | bit | SPARSE NULL, |
| bit55 | bit | SPARSE NULL, |
| bit56 | bit | SPARSE NULL, |
| bit57 | bit | SPARSE NULL, |
| bit58 | bit | SPARSE NULL, |
| bit59 | bit | SPARSE NULL, |
| bit60 | bit | SPARSE NULL, |
| bit61 | bit | SPARSE NULL, |
| bit62 | bit | SPARSE NULL, |
| bit63 | bit | SPARSE NULL, |
| bit64 | bit | SPARSE NULL, |
| bit65 | bit | SPARSE NULL, |
| bit66 | bit | SPARSE NULL, |
| bit67 | bit | SPARSE NULL, |
| bit68 | bit | SPARSE NULL, |
| bit69 | bit | SPARSE NULL, |
| bit70 | bit | SPARSE NULL, |
| bit71 | bit | SPARSE NULL, |
| bit72 | bit | SPARSE NULL, |
| bit73 | bit | SPARSE NULL, |
| bit74 | bit | SPARSE NULL, |
| bit75 | bit | SPARSE NULL, |
| bit76 | bit | SPARSE NULL, |
| bit77 | bit | SPARSE NULL, |
| bit78 | bit | SPARSE NULL, |
| bit79 | bit | SPARSE NULL, |
| bit80 | bit | SPARSE NULL, |
| bit81 | bit | SPARSE NULL, |
| bit82 | bit | SPARSE NULL, |
| bit83 | bit | SPARSE NULL, |
| bit84 | bit | SPARSE NULL, |
| bit85 | bit | SPARSE NULL, |
| bit86 | bit | SPARSE NULL, |
| bit87 | bit | SPARSE NULL, |
| bit88 | bit | SPARSE NULL, |
| bit89 | bit | SPARSE NULL, |
| bit90 | bit | SPARSE NULL, |
| bit91 | bit | SPARSE NULL, |
| bit92 | bit | SPARSE NULL, |
| bit93 | bit | SPARSE NULL, |
| bit94 | bit | SPARSE NULL, |
| bit95 | bit | SPARSE NULL, |
| bit96 | bit | SPARSE NULL, |
| bit97 | bit | SPARSE NULL, |
| bit98 | bit | SPARSE NULL, |

| | | |
|--------|-----|--------------|
| bit99 | bit | SPARSE NULL, |
| bit100 | bit | SPARSE NULL, |
| bit101 | bit | SPARSE NULL, |
| bit102 | bit | SPARSE NULL, |
| bit103 | bit | SPARSE NULL, |
| bit104 | bit | SPARSE NULL, |
| bit105 | bit | SPARSE NULL, |
| bit106 | bit | SPARSE NULL, |
| bit107 | bit | SPARSE NULL, |
| bit108 | bit | SPARSE NULL, |
| bit109 | bit | SPARSE NULL, |
| bit110 | bit | SPARSE NULL, |
| bit111 | bit | SPARSE NULL, |
| bit112 | bit | SPARSE NULL, |
| bit113 | bit | SPARSE NULL, |
| bit114 | bit | SPARSE NULL, |
| bit115 | bit | SPARSE NULL, |
| bit116 | bit | SPARSE NULL, |
| bit117 | bit | SPARSE NULL, |
| bit118 | bit | SPARSE NULL, |
| bit119 | bit | SPARSE NULL, |
| bit120 | bit | SPARSE NULL, |
| bit121 | bit | SPARSE NULL, |
| bit122 | bit | SPARSE NULL, |
| bit123 | bit | SPARSE NULL, |
| bit124 | bit | SPARSE NULL, |
| bit125 | bit | SPARSE NULL, |
| bit126 | bit | SPARSE NULL, |
| bit127 | bit | SPARSE NULL, |
| bit128 | bit | SPARSE NULL, |
| bit129 | bit | SPARSE NULL, |
| bit130 | bit | SPARSE NULL, |
| bit131 | bit | SPARSE NULL, |
| bit132 | bit | SPARSE NULL, |
| bit133 | bit | SPARSE NULL, |
| bit134 | bit | SPARSE NULL, |
| bit135 | bit | SPARSE NULL, |
| bit136 | bit | SPARSE NULL, |
| bit137 | bit | SPARSE NULL, |
| bit138 | bit | SPARSE NULL, |
| bit139 | bit | SPARSE NULL, |
| bit140 | bit | SPARSE NULL, |
| bit141 | bit | SPARSE NULL, |
| bit142 | bit | SPARSE NULL, |
| bit143 | bit | SPARSE NULL, |
| bit144 | bit | SPARSE NULL, |
| bit145 | bit | SPARSE NULL, |
| bit146 | bit | SPARSE NULL, |
| bit147 | bit | SPARSE NULL, |
| bit148 | bit | SPARSE NULL, |
| bit149 | bit | SPARSE NULL, |
| bit150 | bit | SPARSE NULL, |
| bit151 | bit | SPARSE NULL, |
| bit152 | bit | SPARSE NULL, |
| bit153 | bit | SPARSE NULL, |
| bit154 | bit | SPARSE NULL, |
| bit155 | bit | SPARSE NULL, |
| bit156 | bit | SPARSE NULL, |
| bit157 | bit | SPARSE NULL, |

| | | |
|--------|-----|--------------|
| bit158 | bit | SPARSE NULL, |
| bit159 | bit | SPARSE NULL, |
| bit160 | bit | SPARSE NULL, |
| bit161 | bit | SPARSE NULL, |
| bit162 | bit | SPARSE NULL, |
| bit163 | bit | SPARSE NULL, |
| bit164 | bit | SPARSE NULL, |
| bit165 | bit | SPARSE NULL, |
| bit166 | bit | SPARSE NULL, |
| bit167 | bit | SPARSE NULL, |
| bit168 | bit | SPARSE NULL, |
| bit169 | bit | SPARSE NULL, |
| bit170 | bit | SPARSE NULL, |
| bit171 | bit | SPARSE NULL, |
| bit172 | bit | SPARSE NULL, |
| bit173 | bit | SPARSE NULL, |
| bit174 | bit | SPARSE NULL, |
| bit175 | bit | SPARSE NULL, |
| bit176 | bit | SPARSE NULL, |
| bit177 | bit | SPARSE NULL, |
| bit178 | bit | SPARSE NULL, |
| bit179 | bit | SPARSE NULL, |
| bit180 | bit | SPARSE NULL, |
| bit181 | bit | SPARSE NULL, |
| bit182 | bit | SPARSE NULL, |
| bit183 | bit | SPARSE NULL, |
| bit184 | bit | SPARSE NULL, |
| bit185 | bit | SPARSE NULL, |
| bit186 | bit | SPARSE NULL, |
| bit187 | bit | SPARSE NULL, |
| bit188 | bit | SPARSE NULL, |
| bit189 | bit | SPARSE NULL, |
| bit190 | bit | SPARSE NULL, |
| bit191 | bit | SPARSE NULL, |
| bit192 | bit | SPARSE NULL, |
| bit193 | bit | SPARSE NULL, |
| bit194 | bit | SPARSE NULL, |
| bit195 | bit | SPARSE NULL, |
| bit196 | bit | SPARSE NULL, |
| bit197 | bit | SPARSE NULL, |
| bit198 | bit | SPARSE NULL, |
| bit199 | bit | SPARSE NULL, |
| bit200 | bit | SPARSE NULL, |
| bit201 | bit | SPARSE NULL, |
| bit202 | bit | SPARSE NULL, |
| bit203 | bit | SPARSE NULL, |
| bit204 | bit | SPARSE NULL, |
| bit205 | bit | SPARSE NULL, |
| bit206 | bit | SPARSE NULL, |
| bit207 | bit | SPARSE NULL, |
| bit208 | bit | SPARSE NULL, |
| bit209 | bit | SPARSE NULL, |
| bit210 | bit | SPARSE NULL, |
| bit211 | bit | SPARSE NULL, |
| bit212 | bit | SPARSE NULL, |
| bit213 | bit | SPARSE NULL, |
| bit214 | bit | SPARSE NULL, |
| bit215 | bit | SPARSE NULL, |
| bit216 | bit | SPARSE NULL, |

| | | |
|--------|-----|--------------|
| bit217 | bit | SPARSE NULL, |
| bit218 | bit | SPARSE NULL, |
| bit219 | bit | SPARSE NULL, |
| bit220 | bit | SPARSE NULL, |
| bit221 | bit | SPARSE NULL, |
| bit222 | bit | SPARSE NULL, |
| bit223 | bit | SPARSE NULL, |
| bit224 | bit | SPARSE NULL, |
| bit225 | bit | SPARSE NULL, |
| bit226 | bit | SPARSE NULL, |
| bit227 | bit | SPARSE NULL, |
| bit228 | bit | SPARSE NULL, |
| bit229 | bit | SPARSE NULL, |
| bit230 | bit | SPARSE NULL, |
| bit231 | bit | SPARSE NULL, |
| bit232 | bit | SPARSE NULL, |
| bit233 | bit | SPARSE NULL, |
| bit234 | bit | SPARSE NULL, |
| bit235 | bit | SPARSE NULL, |
| bit236 | bit | SPARSE NULL, |
| bit237 | bit | SPARSE NULL, |
| bit238 | bit | SPARSE NULL, |
| bit239 | bit | SPARSE NULL, |
| bit240 | bit | SPARSE NULL, |
| bit241 | bit | SPARSE NULL, |
| bit242 | bit | SPARSE NULL, |
| bit243 | bit | SPARSE NULL, |
| bit244 | bit | SPARSE NULL, |
| bit245 | bit | SPARSE NULL, |
| bit246 | bit | SPARSE NULL, |
| bit247 | bit | SPARSE NULL, |
| bit248 | bit | SPARSE NULL, |
| bit249 | bit | SPARSE NULL, |
| bit250 | bit | SPARSE NULL, |
| bit251 | bit | SPARSE NULL, |
| bit252 | bit | SPARSE NULL, |
| bit253 | bit | SPARSE NULL, |
| bit254 | bit | SPARSE NULL, |
| bit255 | bit | SPARSE NULL, |
| bit256 | bit | SPARSE NULL, |
| bit257 | bit | SPARSE NULL, |
| bit258 | bit | SPARSE NULL, |
| bit259 | bit | SPARSE NULL, |
| bit260 | bit | SPARSE NULL, |
| bit261 | bit | SPARSE NULL, |
| bit262 | bit | SPARSE NULL, |
| bit263 | bit | SPARSE NULL, |
| bit264 | bit | SPARSE NULL, |
| bit265 | bit | SPARSE NULL, |
| bit266 | bit | SPARSE NULL, |
| bit267 | bit | SPARSE NULL, |
| bit268 | bit | SPARSE NULL, |
| bit269 | bit | SPARSE NULL, |
| bit270 | bit | SPARSE NULL, |
| bit271 | bit | SPARSE NULL, |
| bit272 | bit | SPARSE NULL, |
| bit273 | bit | SPARSE NULL, |
| bit274 | bit | SPARSE NULL, |
| bit275 | bit | SPARSE NULL, |

| | | |
|--------|-----|--------------|
| bit276 | bit | SPARSE NULL, |
| bit277 | bit | SPARSE NULL, |
| bit278 | bit | SPARSE NULL, |
| bit279 | bit | SPARSE NULL, |
| bit280 | bit | SPARSE NULL, |
| bit281 | bit | SPARSE NULL, |
| bit282 | bit | SPARSE NULL, |
| bit283 | bit | SPARSE NULL, |
| bit284 | bit | SPARSE NULL, |
| bit285 | bit | SPARSE NULL, |
| bit286 | bit | SPARSE NULL, |
| bit287 | bit | SPARSE NULL, |
| bit288 | bit | SPARSE NULL, |
| bit289 | bit | SPARSE NULL, |
| bit290 | bit | SPARSE NULL, |
| bit291 | bit | SPARSE NULL, |
| bit292 | bit | SPARSE NULL, |
| bit293 | bit | SPARSE NULL, |
| bit294 | bit | SPARSE NULL, |
| bit295 | bit | SPARSE NULL, |
| bit296 | bit | SPARSE NULL, |
| bit297 | bit | SPARSE NULL, |
| bit298 | bit | SPARSE NULL, |
| bit299 | bit | SPARSE NULL, |
| bit300 | bit | SPARSE NULL, |
| bit301 | bit | SPARSE NULL, |
| bit302 | bit | SPARSE NULL, |
| bit303 | bit | SPARSE NULL, |
| bit304 | bit | SPARSE NULL, |
| bit305 | bit | SPARSE NULL, |
| bit306 | bit | SPARSE NULL, |
| bit307 | bit | SPARSE NULL, |
| bit308 | bit | SPARSE NULL, |
| bit309 | bit | SPARSE NULL, |
| bit310 | bit | SPARSE NULL, |
| bit311 | bit | SPARSE NULL, |
| bit312 | bit | SPARSE NULL, |
| bit313 | bit | SPARSE NULL, |
| bit314 | bit | SPARSE NULL, |
| bit315 | bit | SPARSE NULL, |
| bit316 | bit | SPARSE NULL, |
| bit317 | bit | SPARSE NULL, |
| bit318 | bit | SPARSE NULL, |
| bit319 | bit | SPARSE NULL, |
| bit320 | bit | SPARSE NULL, |
| bit321 | bit | SPARSE NULL, |
| bit322 | bit | SPARSE NULL, |
| bit323 | bit | SPARSE NULL, |
| bit324 | bit | SPARSE NULL, |
| bit325 | bit | SPARSE NULL, |
| bit326 | bit | SPARSE NULL, |
| bit327 | bit | SPARSE NULL, |
| bit328 | bit | SPARSE NULL, |
| bit329 | bit | SPARSE NULL, |
| bit330 | bit | SPARSE NULL, |
| bit331 | bit | SPARSE NULL, |
| bit332 | bit | SPARSE NULL, |
| bit333 | bit | SPARSE NULL, |
| bit334 | bit | SPARSE NULL, |

| | | |
|--------|-----|--------------|
| bit335 | bit | SPARSE NULL, |
| bit336 | bit | SPARSE NULL, |
| bit337 | bit | SPARSE NULL, |
| bit338 | bit | SPARSE NULL, |
| bit339 | bit | SPARSE NULL, |
| bit340 | bit | SPARSE NULL, |
| bit341 | bit | SPARSE NULL, |
| bit342 | bit | SPARSE NULL, |
| bit343 | bit | SPARSE NULL, |
| bit344 | bit | SPARSE NULL, |
| bit345 | bit | SPARSE NULL, |
| bit346 | bit | SPARSE NULL, |
| bit347 | bit | SPARSE NULL, |
| bit348 | bit | SPARSE NULL, |
| bit349 | bit | SPARSE NULL, |
| bit350 | bit | SPARSE NULL, |
| bit351 | bit | SPARSE NULL, |
| bit352 | bit | SPARSE NULL, |
| bit353 | bit | SPARSE NULL, |
| bit354 | bit | SPARSE NULL, |
| bit355 | bit | SPARSE NULL, |
| bit356 | bit | SPARSE NULL, |
| bit357 | bit | SPARSE NULL, |
| bit358 | bit | SPARSE NULL, |
| bit359 | bit | SPARSE NULL, |
| bit360 | bit | SPARSE NULL, |
| bit361 | bit | SPARSE NULL, |
| bit362 | bit | SPARSE NULL, |
| bit363 | bit | SPARSE NULL, |
| bit364 | bit | SPARSE NULL, |
| bit365 | bit | SPARSE NULL, |
| bit366 | bit | SPARSE NULL, |
| bit367 | bit | SPARSE NULL, |
| bit368 | bit | SPARSE NULL, |
| bit369 | bit | SPARSE NULL, |
| bit370 | bit | SPARSE NULL, |
| bit371 | bit | SPARSE NULL, |
| bit372 | bit | SPARSE NULL, |
| bit373 | bit | SPARSE NULL, |
| bit374 | bit | SPARSE NULL, |
| bit375 | bit | SPARSE NULL, |
| bit376 | bit | SPARSE NULL, |
| bit377 | bit | SPARSE NULL, |
| bit378 | bit | SPARSE NULL, |
| bit379 | bit | SPARSE NULL, |
| bit380 | bit | SPARSE NULL, |
| bit381 | bit | SPARSE NULL, |
| bit382 | bit | SPARSE NULL, |
| bit383 | bit | SPARSE NULL, |
| bit384 | bit | SPARSE NULL, |
| bit385 | bit | SPARSE NULL, |
| bit386 | bit | SPARSE NULL, |
| bit387 | bit | SPARSE NULL, |
| bit388 | bit | SPARSE NULL, |
| bit389 | bit | SPARSE NULL, |
| bit390 | bit | SPARSE NULL, |
| bit391 | bit | SPARSE NULL, |
| bit392 | bit | SPARSE NULL, |
| bit393 | bit | SPARSE NULL, |

| | | |
|--------|-----|--------------|
| bit394 | bit | SPARSE NULL, |
| bit395 | bit | SPARSE NULL, |
| bit396 | bit | SPARSE NULL, |
| bit397 | bit | SPARSE NULL, |
| bit398 | bit | SPARSE NULL, |
| bit399 | bit | SPARSE NULL, |
| bit400 | bit | SPARSE NULL, |
| bit401 | bit | SPARSE NULL, |
| bit402 | bit | SPARSE NULL, |
| bit403 | bit | SPARSE NULL, |
| bit404 | bit | SPARSE NULL, |
| bit405 | bit | SPARSE NULL, |
| bit406 | bit | SPARSE NULL, |
| bit407 | bit | SPARSE NULL, |
| bit408 | bit | SPARSE NULL, |
| bit409 | bit | SPARSE NULL, |
| bit410 | bit | SPARSE NULL, |
| bit411 | bit | SPARSE NULL, |
| bit412 | bit | SPARSE NULL, |
| bit413 | bit | SPARSE NULL, |
| bit414 | bit | SPARSE NULL, |
| bit415 | bit | SPARSE NULL, |
| bit416 | bit | SPARSE NULL, |
| bit417 | bit | SPARSE NULL, |
| bit418 | bit | SPARSE NULL, |
| bit419 | bit | SPARSE NULL, |
| bit420 | bit | SPARSE NULL, |
| bit421 | bit | SPARSE NULL, |
| bit422 | bit | SPARSE NULL, |
| bit423 | bit | SPARSE NULL, |
| bit424 | bit | SPARSE NULL, |
| bit425 | bit | SPARSE NULL, |
| bit426 | bit | SPARSE NULL, |
| bit427 | bit | SPARSE NULL, |
| bit428 | bit | SPARSE NULL, |
| bit429 | bit | SPARSE NULL, |
| bit430 | bit | SPARSE NULL, |
| bit431 | bit | SPARSE NULL, |
| bit432 | bit | SPARSE NULL, |
| bit433 | bit | SPARSE NULL, |
| bit434 | bit | SPARSE NULL, |
| bit435 | bit | SPARSE NULL, |
| bit436 | bit | SPARSE NULL, |
| bit437 | bit | SPARSE NULL, |
| bit438 | bit | SPARSE NULL, |
| bit439 | bit | SPARSE NULL, |
| bit440 | bit | SPARSE NULL, |
| bit441 | bit | SPARSE NULL, |
| bit442 | bit | SPARSE NULL, |
| bit443 | bit | SPARSE NULL, |
| bit444 | bit | SPARSE NULL, |
| bit445 | bit | SPARSE NULL, |
| bit446 | bit | SPARSE NULL, |
| bit447 | bit | SPARSE NULL, |
| bit448 | bit | SPARSE NULL, |
| bit449 | bit | SPARSE NULL, |
| bit450 | bit | SPARSE NULL, |
| bit451 | bit | SPARSE NULL, |
| bit452 | bit | SPARSE NULL, |

| | | |
|--------|-----|--------------|
| bit453 | bit | SPARSE NULL, |
| bit454 | bit | SPARSE NULL, |
| bit455 | bit | SPARSE NULL, |
| bit456 | bit | SPARSE NULL, |
| bit457 | bit | SPARSE NULL, |
| bit458 | bit | SPARSE NULL, |
| bit459 | bit | SPARSE NULL, |
| bit460 | bit | SPARSE NULL, |
| bit461 | bit | SPARSE NULL, |
| bit462 | bit | SPARSE NULL, |
| bit463 | bit | SPARSE NULL, |
| bit464 | bit | SPARSE NULL, |
| bit465 | bit | SPARSE NULL, |
| bit466 | bit | SPARSE NULL, |
| bit467 | bit | SPARSE NULL, |
| bit468 | bit | SPARSE NULL, |
| bit469 | bit | SPARSE NULL, |
| bit470 | bit | SPARSE NULL, |
| bit471 | bit | SPARSE NULL, |
| bit472 | bit | SPARSE NULL, |
| bit473 | bit | SPARSE NULL, |
| bit474 | bit | SPARSE NULL, |
| bit475 | bit | SPARSE NULL, |
| bit476 | bit | SPARSE NULL, |
| bit477 | bit | SPARSE NULL, |
| bit478 | bit | SPARSE NULL, |
| bit479 | bit | SPARSE NULL, |
| bit480 | bit | SPARSE NULL, |
| bit481 | bit | SPARSE NULL, |
| bit482 | bit | SPARSE NULL, |
| bit483 | bit | SPARSE NULL, |
| bit484 | bit | SPARSE NULL, |
| bit485 | bit | SPARSE NULL, |
| bit486 | bit | SPARSE NULL, |
| bit487 | bit | SPARSE NULL, |
| bit488 | bit | SPARSE NULL, |
| bit489 | bit | SPARSE NULL, |
| bit490 | bit | SPARSE NULL, |
| bit491 | bit | SPARSE NULL, |
| bit492 | bit | SPARSE NULL, |
| bit493 | bit | SPARSE NULL, |
| bit494 | bit | SPARSE NULL, |
| bit495 | bit | SPARSE NULL, |
| bit496 | bit | SPARSE NULL, |
| bit497 | bit | SPARSE NULL, |
| bit498 | bit | SPARSE NULL, |
| bit499 | bit | SPARSE NULL, |
| bit500 | bit | SPARSE NULL, |
| bit501 | bit | SPARSE NULL, |
| bit502 | bit | SPARSE NULL, |
| bit503 | bit | SPARSE NULL, |
| bit504 | bit | SPARSE NULL, |
| bit505 | bit | SPARSE NULL, |
| bit506 | bit | SPARSE NULL, |
| bit507 | bit | SPARSE NULL, |
| bit508 | bit | SPARSE NULL, |
| bit509 | bit | SPARSE NULL, |
| bit510 | bit | SPARSE NULL, |
| bit511 | bit | SPARSE NULL, |

| | | |
|--------|-----|--------------|
| bit512 | bit | SPARSE NULL, |
| bit513 | bit | SPARSE NULL, |
| bit514 | bit | SPARSE NULL, |
| bit515 | bit | SPARSE NULL, |
| bit516 | bit | SPARSE NULL, |
| bit517 | bit | SPARSE NULL, |
| bit518 | bit | SPARSE NULL, |
| bit519 | bit | SPARSE NULL, |
| bit520 | bit | SPARSE NULL, |
| bit521 | bit | SPARSE NULL, |
| bit522 | bit | SPARSE NULL, |
| bit523 | bit | SPARSE NULL, |
| bit524 | bit | SPARSE NULL, |
| bit525 | bit | SPARSE NULL, |
| bit526 | bit | SPARSE NULL, |
| bit527 | bit | SPARSE NULL, |
| bit528 | bit | SPARSE NULL, |
| bit529 | bit | SPARSE NULL, |
| bit530 | bit | SPARSE NULL, |
| bit531 | bit | SPARSE NULL, |
| bit532 | bit | SPARSE NULL, |
| bit533 | bit | SPARSE NULL, |
| bit534 | bit | SPARSE NULL, |
| bit535 | bit | SPARSE NULL, |
| bit536 | bit | SPARSE NULL, |
| bit537 | bit | SPARSE NULL, |
| bit538 | bit | SPARSE NULL, |
| bit539 | bit | SPARSE NULL, |
| bit540 | bit | SPARSE NULL, |
| bit541 | bit | SPARSE NULL, |
| bit542 | bit | SPARSE NULL, |
| bit543 | bit | SPARSE NULL, |
| bit544 | bit | SPARSE NULL, |
| bit545 | bit | SPARSE NULL, |
| bit546 | bit | SPARSE NULL, |
| bit547 | bit | SPARSE NULL, |
| bit548 | bit | SPARSE NULL, |
| bit549 | bit | SPARSE NULL, |
| bit550 | bit | SPARSE NULL, |
| bit551 | bit | SPARSE NULL, |
| bit552 | bit | SPARSE NULL, |
| bit553 | bit | SPARSE NULL, |
| bit554 | bit | SPARSE NULL, |
| bit555 | bit | SPARSE NULL, |
| bit556 | bit | SPARSE NULL, |
| bit557 | bit | SPARSE NULL, |
| bit558 | bit | SPARSE NULL, |
| bit559 | bit | SPARSE NULL, |
| bit560 | bit | SPARSE NULL, |
| bit561 | bit | SPARSE NULL, |
| bit562 | bit | SPARSE NULL, |
| bit563 | bit | SPARSE NULL, |
| bit564 | bit | SPARSE NULL, |
| bit565 | bit | SPARSE NULL, |
| bit566 | bit | SPARSE NULL, |
| bit567 | bit | SPARSE NULL, |
| bit568 | bit | SPARSE NULL, |
| bit569 | bit | SPARSE NULL, |
| bit570 | bit | SPARSE NULL, |

| | | |
|--------|-----|--------------|
| bit571 | bit | SPARSE NULL, |
| bit572 | bit | SPARSE NULL, |
| bit573 | bit | SPARSE NULL, |
| bit574 | bit | SPARSE NULL, |
| bit575 | bit | SPARSE NULL, |
| bit576 | bit | SPARSE NULL, |
| bit577 | bit | SPARSE NULL, |
| bit578 | bit | SPARSE NULL, |
| bit579 | bit | SPARSE NULL, |
| bit580 | bit | SPARSE NULL, |
| bit581 | bit | SPARSE NULL, |
| bit582 | bit | SPARSE NULL, |
| bit583 | bit | SPARSE NULL, |
| bit584 | bit | SPARSE NULL, |
| bit585 | bit | SPARSE NULL, |
| bit586 | bit | SPARSE NULL, |
| bit587 | bit | SPARSE NULL, |
| bit588 | bit | SPARSE NULL, |
| bit589 | bit | SPARSE NULL, |
| bit590 | bit | SPARSE NULL, |
| bit591 | bit | SPARSE NULL, |
| bit592 | bit | SPARSE NULL, |
| bit593 | bit | SPARSE NULL, |
| bit594 | bit | SPARSE NULL, |
| bit595 | bit | SPARSE NULL, |
| bit596 | bit | SPARSE NULL, |
| bit597 | bit | SPARSE NULL, |
| bit598 | bit | SPARSE NULL, |
| bit599 | bit | SPARSE NULL, |
| bit600 | bit | SPARSE NULL, |
| bit601 | bit | SPARSE NULL, |
| bit602 | bit | SPARSE NULL, |
| bit603 | bit | SPARSE NULL, |
| bit604 | bit | SPARSE NULL, |
| bit605 | bit | SPARSE NULL, |
| bit606 | bit | SPARSE NULL, |
| bit607 | bit | SPARSE NULL, |
| bit608 | bit | SPARSE NULL, |
| bit609 | bit | SPARSE NULL, |
| bit610 | bit | SPARSE NULL, |
| bit611 | bit | SPARSE NULL, |
| bit612 | bit | SPARSE NULL, |
| bit613 | bit | SPARSE NULL, |
| bit614 | bit | SPARSE NULL, |
| bit615 | bit | SPARSE NULL, |
| bit616 | bit | SPARSE NULL, |
| bit617 | bit | SPARSE NULL, |
| bit618 | bit | SPARSE NULL, |
| bit619 | bit | SPARSE NULL, |
| bit620 | bit | SPARSE NULL, |
| bit621 | bit | SPARSE NULL, |
| bit622 | bit | SPARSE NULL, |
| bit623 | bit | SPARSE NULL, |
| bit624 | bit | SPARSE NULL, |
| bit625 | bit | SPARSE NULL, |
| bit626 | bit | SPARSE NULL, |
| bit627 | bit | SPARSE NULL, |
| bit628 | bit | SPARSE NULL, |
| bit629 | bit | SPARSE NULL, |

| | | |
|--------|-----|--------------|
| bit630 | bit | SPARSE NULL, |
| bit631 | bit | SPARSE NULL, |
| bit632 | bit | SPARSE NULL, |
| bit633 | bit | SPARSE NULL, |
| bit634 | bit | SPARSE NULL, |
| bit635 | bit | SPARSE NULL, |
| bit636 | bit | SPARSE NULL, |
| bit637 | bit | SPARSE NULL, |
| bit638 | bit | SPARSE NULL, |
| bit639 | bit | SPARSE NULL, |
| bit640 | bit | SPARSE NULL, |
| bit641 | bit | SPARSE NULL, |
| bit642 | bit | SPARSE NULL, |
| bit643 | bit | SPARSE NULL, |
| bit644 | bit | SPARSE NULL, |
| bit645 | bit | SPARSE NULL, |
| bit646 | bit | SPARSE NULL, |
| bit647 | bit | SPARSE NULL, |
| bit648 | bit | SPARSE NULL, |
| bit649 | bit | SPARSE NULL, |
| bit650 | bit | SPARSE NULL, |
| bit651 | bit | SPARSE NULL, |
| bit652 | bit | SPARSE NULL, |
| bit653 | bit | SPARSE NULL, |
| bit654 | bit | SPARSE NULL, |
| bit655 | bit | SPARSE NULL, |
| bit656 | bit | SPARSE NULL, |
| bit657 | bit | SPARSE NULL, |
| bit658 | bit | SPARSE NULL, |
| bit659 | bit | SPARSE NULL, |
| bit660 | bit | SPARSE NULL, |
| bit661 | bit | SPARSE NULL, |
| bit662 | bit | SPARSE NULL, |
| bit663 | bit | SPARSE NULL, |
| bit664 | bit | SPARSE NULL, |
| bit665 | bit | SPARSE NULL, |
| bit666 | bit | SPARSE NULL, |
| bit667 | bit | SPARSE NULL, |
| bit668 | bit | SPARSE NULL, |
| bit669 | bit | SPARSE NULL, |
| bit670 | bit | SPARSE NULL, |
| bit671 | bit | SPARSE NULL, |
| bit672 | bit | SPARSE NULL, |
| bit673 | bit | SPARSE NULL, |
| bit674 | bit | SPARSE NULL, |
| bit675 | bit | SPARSE NULL, |
| bit676 | bit | SPARSE NULL, |
| bit677 | bit | SPARSE NULL, |
| bit678 | bit | SPARSE NULL, |
| bit679 | bit | SPARSE NULL, |
| bit680 | bit | SPARSE NULL, |
| bit681 | bit | SPARSE NULL, |
| bit682 | bit | SPARSE NULL, |
| bit683 | bit | SPARSE NULL, |
| bit684 | bit | SPARSE NULL, |
| bit685 | bit | SPARSE NULL, |
| bit686 | bit | SPARSE NULL, |
| bit687 | bit | SPARSE NULL, |
| bit688 | bit | SPARSE NULL, |

| | | |
|--------|-----|--------------|
| bit689 | bit | SPARSE NULL, |
| bit690 | bit | SPARSE NULL, |
| bit691 | bit | SPARSE NULL, |
| bit692 | bit | SPARSE NULL, |
| bit693 | bit | SPARSE NULL, |
| bit694 | bit | SPARSE NULL, |
| bit695 | bit | SPARSE NULL, |
| bit696 | bit | SPARSE NULL, |
| bit697 | bit | SPARSE NULL, |
| bit698 | bit | SPARSE NULL, |
| bit699 | bit | SPARSE NULL, |
| bit700 | bit | SPARSE NULL, |
| bit701 | bit | SPARSE NULL, |
| bit702 | bit | SPARSE NULL, |
| bit703 | bit | SPARSE NULL, |
| bit704 | bit | SPARSE NULL, |
| bit705 | bit | SPARSE NULL, |
| bit706 | bit | SPARSE NULL, |
| bit707 | bit | SPARSE NULL, |
| bit708 | bit | SPARSE NULL, |
| bit709 | bit | SPARSE NULL, |
| bit710 | bit | SPARSE NULL, |
| bit711 | bit | SPARSE NULL, |
| bit712 | bit | SPARSE NULL, |
| bit713 | bit | SPARSE NULL, |
| bit714 | bit | SPARSE NULL, |
| bit715 | bit | SPARSE NULL, |
| bit716 | bit | SPARSE NULL, |
| bit717 | bit | SPARSE NULL, |
| bit718 | bit | SPARSE NULL, |
| bit719 | bit | SPARSE NULL, |
| bit720 | bit | SPARSE NULL, |
| bit721 | bit | SPARSE NULL, |
| bit722 | bit | SPARSE NULL, |
| bit723 | bit | SPARSE NULL, |
| bit724 | bit | SPARSE NULL, |
| bit725 | bit | SPARSE NULL, |
| bit726 | bit | SPARSE NULL, |
| bit727 | bit | SPARSE NULL, |
| bit728 | bit | SPARSE NULL, |
| bit729 | bit | SPARSE NULL, |
| bit730 | bit | SPARSE NULL, |
| bit731 | bit | SPARSE NULL, |
| bit732 | bit | SPARSE NULL, |
| bit733 | bit | SPARSE NULL, |
| bit734 | bit | SPARSE NULL, |
| bit735 | bit | SPARSE NULL, |
| bit736 | bit | SPARSE NULL, |
| bit737 | bit | SPARSE NULL, |
| bit738 | bit | SPARSE NULL, |
| bit739 | bit | SPARSE NULL, |
| bit740 | bit | SPARSE NULL, |
| bit741 | bit | SPARSE NULL, |
| bit742 | bit | SPARSE NULL, |
| bit743 | bit | SPARSE NULL, |
| bit744 | bit | SPARSE NULL, |
| bit745 | bit | SPARSE NULL, |
| bit746 | bit | SPARSE NULL, |
| bit747 | bit | SPARSE NULL, |

| | | |
|--------|-----|--------------|
| bit748 | bit | SPARSE NULL, |
| bit749 | bit | SPARSE NULL, |
| bit750 | bit | SPARSE NULL, |
| bit751 | bit | SPARSE NULL, |
| bit752 | bit | SPARSE NULL, |
| bit753 | bit | SPARSE NULL, |
| bit754 | bit | SPARSE NULL, |
| bit755 | bit | SPARSE NULL, |
| bit756 | bit | SPARSE NULL, |
| bit757 | bit | SPARSE NULL, |
| bit758 | bit | SPARSE NULL, |
| bit759 | bit | SPARSE NULL, |
| bit760 | bit | SPARSE NULL, |
| bit761 | bit | SPARSE NULL, |
| bit762 | bit | SPARSE NULL, |
| bit763 | bit | SPARSE NULL, |
| bit764 | bit | SPARSE NULL, |
| bit765 | bit | SPARSE NULL, |
| bit766 | bit | SPARSE NULL, |
| bit767 | bit | SPARSE NULL, |
| bit768 | bit | SPARSE NULL, |
| bit769 | bit | SPARSE NULL, |
| bit770 | bit | SPARSE NULL, |
| bit771 | bit | SPARSE NULL, |
| bit772 | bit | SPARSE NULL, |
| bit773 | bit | SPARSE NULL, |
| bit774 | bit | SPARSE NULL, |
| bit775 | bit | SPARSE NULL, |
| bit776 | bit | SPARSE NULL, |
| bit777 | bit | SPARSE NULL, |
| bit778 | bit | SPARSE NULL, |
| bit779 | bit | SPARSE NULL, |
| bit780 | bit | SPARSE NULL, |
| bit781 | bit | SPARSE NULL, |
| bit782 | bit | SPARSE NULL, |
| bit783 | bit | SPARSE NULL, |
| bit784 | bit | SPARSE NULL, |
| bit785 | bit | SPARSE NULL, |
| bit786 | bit | SPARSE NULL, |
| bit787 | bit | SPARSE NULL, |
| bit788 | bit | SPARSE NULL, |
| bit789 | bit | SPARSE NULL, |
| bit790 | bit | SPARSE NULL, |
| bit791 | bit | SPARSE NULL, |
| bit792 | bit | SPARSE NULL, |
| bit793 | bit | SPARSE NULL, |
| bit794 | bit | SPARSE NULL, |
| bit795 | bit | SPARSE NULL, |
| bit796 | bit | SPARSE NULL, |
| bit797 | bit | SPARSE NULL, |
| bit798 | bit | SPARSE NULL, |
| bit799 | bit | SPARSE NULL, |
| bit800 | bit | SPARSE NULL, |
| bit801 | bit | SPARSE NULL, |
| bit802 | bit | SPARSE NULL, |
| bit803 | bit | SPARSE NULL, |
| bit804 | bit | SPARSE NULL, |
| bit805 | bit | SPARSE NULL, |
| bit806 | bit | SPARSE NULL, |

| | | |
|--------|-----|--------------|
| bit807 | bit | SPARSE NULL, |
| bit808 | bit | SPARSE NULL, |
| bit809 | bit | SPARSE NULL, |
| bit810 | bit | SPARSE NULL, |
| bit811 | bit | SPARSE NULL, |
| bit812 | bit | SPARSE NULL, |
| bit813 | bit | SPARSE NULL, |
| bit814 | bit | SPARSE NULL, |
| bit815 | bit | SPARSE NULL, |
| bit816 | bit | SPARSE NULL, |
| bit817 | bit | SPARSE NULL, |
| bit818 | bit | SPARSE NULL, |
| bit819 | bit | SPARSE NULL, |
| bit820 | bit | SPARSE NULL, |
| bit821 | bit | SPARSE NULL, |
| bit822 | bit | SPARSE NULL, |
| bit823 | bit | SPARSE NULL, |
| bit824 | bit | SPARSE NULL, |
| bit825 | bit | SPARSE NULL, |
| bit826 | bit | SPARSE NULL, |
| bit827 | bit | SPARSE NULL, |
| bit828 | bit | SPARSE NULL, |
| bit829 | bit | SPARSE NULL, |
| bit830 | bit | SPARSE NULL, |
| bit831 | bit | SPARSE NULL, |
| bit832 | bit | SPARSE NULL, |
| bit833 | bit | SPARSE NULL, |
| bit834 | bit | SPARSE NULL, |
| bit835 | bit | SPARSE NULL, |
| bit836 | bit | SPARSE NULL, |
| bit837 | bit | SPARSE NULL, |
| bit838 | bit | SPARSE NULL, |
| bit839 | bit | SPARSE NULL, |
| bit840 | bit | SPARSE NULL, |
| bit841 | bit | SPARSE NULL, |
| bit842 | bit | SPARSE NULL, |
| bit843 | bit | SPARSE NULL, |
| bit844 | bit | SPARSE NULL, |
| bit845 | bit | SPARSE NULL, |
| bit846 | bit | SPARSE NULL, |
| bit847 | bit | SPARSE NULL, |
| bit848 | bit | SPARSE NULL, |
| bit849 | bit | SPARSE NULL, |
| bit850 | bit | SPARSE NULL, |
| bit851 | bit | SPARSE NULL, |
| bit852 | bit | SPARSE NULL, |
| bit853 | bit | SPARSE NULL, |
| bit854 | bit | SPARSE NULL, |
| bit855 | bit | SPARSE NULL, |
| bit856 | bit | SPARSE NULL, |
| bit857 | bit | SPARSE NULL, |
| bit858 | bit | SPARSE NULL, |
| bit859 | bit | SPARSE NULL, |
| bit860 | bit | SPARSE NULL, |
| bit861 | bit | SPARSE NULL, |
| bit862 | bit | SPARSE NULL, |
| bit863 | bit | SPARSE NULL, |
| bit864 | bit | SPARSE NULL, |
| bit865 | bit | SPARSE NULL, |

| | | |
|--------|-----|--------------|
| bit866 | bit | SPARSE NULL, |
| bit867 | bit | SPARSE NULL, |
| bit868 | bit | SPARSE NULL, |
| bit869 | bit | SPARSE NULL, |
| bit870 | bit | SPARSE NULL, |
| bit871 | bit | SPARSE NULL, |
| bit872 | bit | SPARSE NULL, |
| bit873 | bit | SPARSE NULL, |
| bit874 | bit | SPARSE NULL, |
| bit875 | bit | SPARSE NULL, |
| bit876 | bit | SPARSE NULL, |
| bit877 | bit | SPARSE NULL, |
| bit878 | bit | SPARSE NULL, |
| bit879 | bit | SPARSE NULL, |
| bit880 | bit | SPARSE NULL, |
| bit881 | bit | SPARSE NULL, |
| bit882 | bit | SPARSE NULL, |
| bit883 | bit | SPARSE NULL, |
| bit884 | bit | SPARSE NULL, |
| bit885 | bit | SPARSE NULL, |
| bit886 | bit | SPARSE NULL, |
| bit887 | bit | SPARSE NULL, |
| bit888 | bit | SPARSE NULL, |
| bit889 | bit | SPARSE NULL, |
| bit890 | bit | SPARSE NULL, |
| bit891 | bit | SPARSE NULL, |
| bit892 | bit | SPARSE NULL, |
| bit893 | bit | SPARSE NULL, |
| bit894 | bit | SPARSE NULL, |
| bit895 | bit | SPARSE NULL, |
| bit896 | bit | SPARSE NULL, |
| bit897 | bit | SPARSE NULL, |
| bit898 | bit | SPARSE NULL, |
| bit899 | bit | SPARSE NULL, |
| bit900 | bit | SPARSE NULL, |
| bit901 | bit | SPARSE NULL, |
| bit902 | bit | SPARSE NULL, |
| bit903 | bit | SPARSE NULL, |
| bit904 | bit | SPARSE NULL, |
| bit905 | bit | SPARSE NULL, |
| bit906 | bit | SPARSE NULL, |
| bit907 | bit | SPARSE NULL, |
| bit908 | bit | SPARSE NULL, |
| bit909 | bit | SPARSE NULL, |
| bit910 | bit | SPARSE NULL, |
| bit911 | bit | SPARSE NULL, |
| bit912 | bit | SPARSE NULL, |
| bit913 | bit | SPARSE NULL, |
| bit914 | bit | SPARSE NULL, |
| bit915 | bit | SPARSE NULL, |
| bit916 | bit | SPARSE NULL, |
| bit917 | bit | SPARSE NULL, |
| bit918 | bit | SPARSE NULL, |
| bit919 | bit | SPARSE NULL, |
| bit920 | bit | SPARSE NULL, |
| bit921 | bit | SPARSE NULL, |
| bit922 | bit | SPARSE NULL, |
| bit923 | bit | SPARSE NULL, |
| bit924 | bit | SPARSE NULL, |

| | | |
|--------|-----|--------------|
| bit925 | bit | SPARSE NULL, |
| bit926 | bit | SPARSE NULL, |
| bit927 | bit | SPARSE NULL, |
| bit928 | bit | SPARSE NULL, |
| bit929 | bit | SPARSE NULL, |
| bit930 | bit | SPARSE NULL, |
| bit931 | bit | SPARSE NULL, |
| bit932 | bit | SPARSE NULL, |
| bit933 | bit | SPARSE NULL, |
| bit934 | bit | SPARSE NULL, |
| bit935 | bit | SPARSE NULL, |
| bit936 | bit | SPARSE NULL, |
| bit937 | bit | SPARSE NULL, |
| bit938 | bit | SPARSE NULL, |
| bit939 | bit | SPARSE NULL, |
| bit940 | bit | SPARSE NULL, |
| bit941 | bit | SPARSE NULL, |
| bit942 | bit | SPARSE NULL, |
| bit943 | bit | SPARSE NULL, |
| bit944 | bit | SPARSE NULL, |
| bit945 | bit | SPARSE NULL, |
| bit946 | bit | SPARSE NULL, |
| bit947 | bit | SPARSE NULL, |
| bit948 | bit | SPARSE NULL, |
| bit949 | bit | SPARSE NULL, |
| bit950 | bit | SPARSE NULL, |
| bit951 | bit | SPARSE NULL, |
| bit952 | bit | SPARSE NULL, |
| bit953 | bit | SPARSE NULL, |
| bit954 | bit | SPARSE NULL, |
| bit955 | bit | SPARSE NULL, |
| bit956 | bit | SPARSE NULL, |
| bit957 | bit | SPARSE NULL, |
| bit958 | bit | SPARSE NULL, |
| bit959 | bit | SPARSE NULL, |
| bit960 | bit | SPARSE NULL, |
| bit961 | bit | SPARSE NULL, |
| bit962 | bit | SPARSE NULL, |
| bit963 | bit | SPARSE NULL, |
| bit964 | bit | SPARSE NULL, |
| bit965 | bit | SPARSE NULL, |
| bit966 | bit | SPARSE NULL, |
| bit967 | bit | SPARSE NULL, |
| bit968 | bit | SPARSE NULL, |
| bit969 | bit | SPARSE NULL, |
| bit970 | bit | SPARSE NULL, |
| bit971 | bit | SPARSE NULL, |
| bit972 | bit | SPARSE NULL, |
| bit973 | bit | SPARSE NULL, |
| bit974 | bit | SPARSE NULL, |
| bit975 | bit | SPARSE NULL, |
| bit976 | bit | SPARSE NULL, |
| bit977 | bit | SPARSE NULL, |
| bit978 | bit | SPARSE NULL, |
| bit979 | bit | SPARSE NULL, |
| bit980 | bit | SPARSE NULL, |
| bit981 | bit | SPARSE NULL, |
| bit982 | bit | SPARSE NULL, |
| bit983 | bit | SPARSE NULL, |

| | | |
|------------|----------|--------------|
| bit984 | bit | SPARSE NULL, |
| bit985 | bit | SPARSE NULL, |
| bit986 | bit | SPARSE NULL, |
| bit987 | bit | SPARSE NULL, |
| bit988 | bit | SPARSE NULL, |
| bit989 | bit | SPARSE NULL, |
| bit990 | bit | SPARSE NULL, |
| bit991 | bit | SPARSE NULL, |
| bit992 | bit | SPARSE NULL, |
| bit993 | bit | SPARSE NULL, |
| bit994 | bit | SPARSE NULL, |
| bit995 | bit | SPARSE NULL, |
| bit996 | bit | SPARSE NULL, |
| bit997 | bit | SPARSE NULL, |
| bit998 | bit | SPARSE NULL, |
| bit999 | bit | SPARSE NULL, |
| bit1000 | bit | SPARSE NULL, |
| datetime1 | datetime | SPARSE NULL, |
| datetime2 | datetime | SPARSE NULL, |
| datetime3 | datetime | SPARSE NULL, |
| datetime4 | datetime | SPARSE NULL, |
| datetime5 | datetime | SPARSE NULL, |
| datetime6 | datetime | SPARSE NULL, |
| datetime7 | datetime | SPARSE NULL, |
| datetime8 | datetime | SPARSE NULL, |
| datetime9 | datetime | SPARSE NULL, |
| datetime10 | datetime | SPARSE NULL, |
| datetime11 | datetime | SPARSE NULL, |
| datetime12 | datetime | SPARSE NULL, |
| datetime13 | datetime | SPARSE NULL, |
| datetime14 | datetime | SPARSE NULL, |
| datetime15 | datetime | SPARSE NULL, |
| datetime16 | datetime | SPARSE NULL, |
| datetime17 | datetime | SPARSE NULL, |
| datetime18 | datetime | SPARSE NULL, |
| datetime19 | datetime | SPARSE NULL, |
| datetime20 | datetime | SPARSE NULL, |
| datetime21 | datetime | SPARSE NULL, |
| datetime22 | datetime | SPARSE NULL, |
| datetime23 | datetime | SPARSE NULL, |
| datetime24 | datetime | SPARSE NULL, |
| datetime25 | datetime | SPARSE NULL, |
| datetime26 | datetime | SPARSE NULL, |
| datetime27 | datetime | SPARSE NULL, |
| datetime28 | datetime | SPARSE NULL, |
| datetime29 | datetime | SPARSE NULL, |
| datetime30 | datetime | SPARSE NULL, |
| datetime31 | datetime | SPARSE NULL, |
| datetime32 | datetime | SPARSE NULL, |
| datetime33 | datetime | SPARSE NULL, |
| datetime34 | datetime | SPARSE NULL, |
| datetime35 | datetime | SPARSE NULL, |
| datetime36 | datetime | SPARSE NULL, |
| datetime37 | datetime | SPARSE NULL, |
| datetime38 | datetime | SPARSE NULL, |
| datetime39 | datetime | SPARSE NULL, |
| datetime40 | datetime | SPARSE NULL, |
| datetime41 | datetime | SPARSE NULL, |
| datetime42 | datetime | SPARSE NULL, |

| | | |
|-------------|----------|--------------|
| datetime43 | datetime | SPARSE NULL, |
| datetime44 | datetime | SPARSE NULL, |
| datetime45 | datetime | SPARSE NULL, |
| datetime46 | datetime | SPARSE NULL, |
| datetime47 | datetime | SPARSE NULL, |
| datetime48 | datetime | SPARSE NULL, |
| datetime49 | datetime | SPARSE NULL, |
| datetime50 | datetime | SPARSE NULL, |
| datetime51 | datetime | SPARSE NULL, |
| datetime52 | datetime | SPARSE NULL, |
| datetime53 | datetime | SPARSE NULL, |
| datetime54 | datetime | SPARSE NULL, |
| datetime55 | datetime | SPARSE NULL, |
| datetime56 | datetime | SPARSE NULL, |
| datetime57 | datetime | SPARSE NULL, |
| datetime58 | datetime | SPARSE NULL, |
| datetime59 | datetime | SPARSE NULL, |
| datetime60 | datetime | SPARSE NULL, |
| datetime61 | datetime | SPARSE NULL, |
| datetime62 | datetime | SPARSE NULL, |
| datetime63 | datetime | SPARSE NULL, |
| datetime64 | datetime | SPARSE NULL, |
| datetime65 | datetime | SPARSE NULL, |
| datetime66 | datetime | SPARSE NULL, |
| datetime67 | datetime | SPARSE NULL, |
| datetime68 | datetime | SPARSE NULL, |
| datetime69 | datetime | SPARSE NULL, |
| datetime70 | datetime | SPARSE NULL, |
| datetime71 | datetime | SPARSE NULL, |
| datetime72 | datetime | SPARSE NULL, |
| datetime73 | datetime | SPARSE NULL, |
| datetime74 | datetime | SPARSE NULL, |
| datetime75 | datetime | SPARSE NULL, |
| datetime76 | datetime | SPARSE NULL, |
| datetime77 | datetime | SPARSE NULL, |
| datetime78 | datetime | SPARSE NULL, |
| datetime79 | datetime | SPARSE NULL, |
| datetime80 | datetime | SPARSE NULL, |
| datetime81 | datetime | SPARSE NULL, |
| datetime82 | datetime | SPARSE NULL, |
| datetime83 | datetime | SPARSE NULL, |
| datetime84 | datetime | SPARSE NULL, |
| datetime85 | datetime | SPARSE NULL, |
| datetime86 | datetime | SPARSE NULL, |
| datetime87 | datetime | SPARSE NULL, |
| datetime88 | datetime | SPARSE NULL, |
| datetime89 | datetime | SPARSE NULL, |
| datetime90 | datetime | SPARSE NULL, |
| datetime91 | datetime | SPARSE NULL, |
| datetime92 | datetime | SPARSE NULL, |
| datetime93 | datetime | SPARSE NULL, |
| datetime94 | datetime | SPARSE NULL, |
| datetime95 | datetime | SPARSE NULL, |
| datetime96 | datetime | SPARSE NULL, |
| datetime97 | datetime | SPARSE NULL, |
| datetime98 | datetime | SPARSE NULL, |
| datetime99 | datetime | SPARSE NULL, |
| datetime100 | datetime | SPARSE NULL, |
| datetime101 | datetime | SPARSE NULL, |

| | | |
|-------------|----------|--------------|
| datetime102 | datetime | SPARSE NULL, |
| datetime103 | datetime | SPARSE NULL, |
| datetime104 | datetime | SPARSE NULL, |
| datetime105 | datetime | SPARSE NULL, |
| datetime106 | datetime | SPARSE NULL, |
| datetime107 | datetime | SPARSE NULL, |
| datetime108 | datetime | SPARSE NULL, |
| datetime109 | datetime | SPARSE NULL, |
| datetime110 | datetime | SPARSE NULL, |
| datetime111 | datetime | SPARSE NULL, |
| datetime112 | datetime | SPARSE NULL, |
| datetime113 | datetime | SPARSE NULL, |
| datetime114 | datetime | SPARSE NULL, |
| datetime115 | datetime | SPARSE NULL, |
| datetime116 | datetime | SPARSE NULL, |
| datetime117 | datetime | SPARSE NULL, |
| datetime118 | datetime | SPARSE NULL, |
| datetime119 | datetime | SPARSE NULL, |
| datetime120 | datetime | SPARSE NULL, |
| datetime121 | datetime | SPARSE NULL, |
| datetime122 | datetime | SPARSE NULL, |
| datetime123 | datetime | SPARSE NULL, |
| datetime124 | datetime | SPARSE NULL, |
| datetime125 | datetime | SPARSE NULL, |
| datetime126 | datetime | SPARSE NULL, |
| datetime127 | datetime | SPARSE NULL, |
| datetime128 | datetime | SPARSE NULL, |
| datetime129 | datetime | SPARSE NULL, |
| datetime130 | datetime | SPARSE NULL, |
| datetime131 | datetime | SPARSE NULL, |
| datetime132 | datetime | SPARSE NULL, |
| datetime133 | datetime | SPARSE NULL, |
| datetime134 | datetime | SPARSE NULL, |
| datetime135 | datetime | SPARSE NULL, |
| datetime136 | datetime | SPARSE NULL, |
| datetime137 | datetime | SPARSE NULL, |
| datetime138 | datetime | SPARSE NULL, |
| datetime139 | datetime | SPARSE NULL, |
| datetime140 | datetime | SPARSE NULL, |
| datetime141 | datetime | SPARSE NULL, |
| datetime142 | datetime | SPARSE NULL, |
| datetime143 | datetime | SPARSE NULL, |
| datetime144 | datetime | SPARSE NULL, |
| datetime145 | datetime | SPARSE NULL, |
| datetime146 | datetime | SPARSE NULL, |
| datetime147 | datetime | SPARSE NULL, |
| datetime148 | datetime | SPARSE NULL, |
| datetime149 | datetime | SPARSE NULL, |
| datetime150 | datetime | SPARSE NULL, |
| datetime151 | datetime | SPARSE NULL, |
| datetime152 | datetime | SPARSE NULL, |
| datetime153 | datetime | SPARSE NULL, |
| datetime154 | datetime | SPARSE NULL, |
| datetime155 | datetime | SPARSE NULL, |
| datetime156 | datetime | SPARSE NULL, |
| datetime157 | datetime | SPARSE NULL, |
| datetime158 | datetime | SPARSE NULL, |
| datetime159 | datetime | SPARSE NULL, |
| datetime160 | datetime | SPARSE NULL, |

| | | |
|-------------|----------|--------------|
| datetime161 | datetime | SPARSE NULL, |
| datetime162 | datetime | SPARSE NULL, |
| datetime163 | datetime | SPARSE NULL, |
| datetime164 | datetime | SPARSE NULL, |
| datetime165 | datetime | SPARSE NULL, |
| datetime166 | datetime | SPARSE NULL, |
| datetime167 | datetime | SPARSE NULL, |
| datetime168 | datetime | SPARSE NULL, |
| datetime169 | datetime | SPARSE NULL, |
| datetime170 | datetime | SPARSE NULL, |
| datetime171 | datetime | SPARSE NULL, |
| datetime172 | datetime | SPARSE NULL, |
| datetime173 | datetime | SPARSE NULL, |
| datetime174 | datetime | SPARSE NULL, |
| datetime175 | datetime | SPARSE NULL, |
| datetime176 | datetime | SPARSE NULL, |
| datetime177 | datetime | SPARSE NULL, |
| datetime178 | datetime | SPARSE NULL, |
| datetime179 | datetime | SPARSE NULL, |
| datetime180 | datetime | SPARSE NULL, |
| datetime181 | datetime | SPARSE NULL, |
| datetime182 | datetime | SPARSE NULL, |
| datetime183 | datetime | SPARSE NULL, |
| datetime184 | datetime | SPARSE NULL, |
| datetime185 | datetime | SPARSE NULL, |
| datetime186 | datetime | SPARSE NULL, |
| datetime187 | datetime | SPARSE NULL, |
| datetime188 | datetime | SPARSE NULL, |
| datetime189 | datetime | SPARSE NULL, |
| datetime190 | datetime | SPARSE NULL, |
| datetime191 | datetime | SPARSE NULL, |
| datetime192 | datetime | SPARSE NULL, |
| datetime193 | datetime | SPARSE NULL, |
| datetime194 | datetime | SPARSE NULL, |
| datetime195 | datetime | SPARSE NULL, |
| datetime196 | datetime | SPARSE NULL, |
| datetime197 | datetime | SPARSE NULL, |
| datetime198 | datetime | SPARSE NULL, |
| datetime199 | datetime | SPARSE NULL, |
| datetime200 | datetime | SPARSE NULL, |
| datetime201 | datetime | SPARSE NULL, |
| datetime202 | datetime | SPARSE NULL, |
| datetime203 | datetime | SPARSE NULL, |
| datetime204 | datetime | SPARSE NULL, |
| datetime205 | datetime | SPARSE NULL, |
| datetime206 | datetime | SPARSE NULL, |
| datetime207 | datetime | SPARSE NULL, |
| datetime208 | datetime | SPARSE NULL, |
| datetime209 | datetime | SPARSE NULL, |
| datetime210 | datetime | SPARSE NULL, |
| datetime211 | datetime | SPARSE NULL, |
| datetime212 | datetime | SPARSE NULL, |
| datetime213 | datetime | SPARSE NULL, |
| datetime214 | datetime | SPARSE NULL, |
| datetime215 | datetime | SPARSE NULL, |
| datetime216 | datetime | SPARSE NULL, |
| datetime217 | datetime | SPARSE NULL, |
| datetime218 | datetime | SPARSE NULL, |
| datetime219 | datetime | SPARSE NULL, |

| | | |
|-------------|----------|--------------|
| datetime220 | datetime | SPARSE NULL, |
| datetime221 | datetime | SPARSE NULL, |
| datetime222 | datetime | SPARSE NULL, |
| datetime223 | datetime | SPARSE NULL, |
| datetime224 | datetime | SPARSE NULL, |
| datetime225 | datetime | SPARSE NULL, |
| datetime226 | datetime | SPARSE NULL, |
| datetime227 | datetime | SPARSE NULL, |
| datetime228 | datetime | SPARSE NULL, |
| datetime229 | datetime | SPARSE NULL, |
| datetime230 | datetime | SPARSE NULL, |
| datetime231 | datetime | SPARSE NULL, |
| datetime232 | datetime | SPARSE NULL, |
| datetime233 | datetime | SPARSE NULL, |
| datetime234 | datetime | SPARSE NULL, |
| datetime235 | datetime | SPARSE NULL, |
| datetime236 | datetime | SPARSE NULL, |
| datetime237 | datetime | SPARSE NULL, |
| datetime238 | datetime | SPARSE NULL, |
| datetime239 | datetime | SPARSE NULL, |
| datetime240 | datetime | SPARSE NULL, |
| datetime241 | datetime | SPARSE NULL, |
| datetime242 | datetime | SPARSE NULL, |
| datetime243 | datetime | SPARSE NULL, |
| datetime244 | datetime | SPARSE NULL, |
| datetime245 | datetime | SPARSE NULL, |
| datetime246 | datetime | SPARSE NULL, |
| datetime247 | datetime | SPARSE NULL, |
| datetime248 | datetime | SPARSE NULL, |
| datetime249 | datetime | SPARSE NULL, |
| datetime250 | datetime | SPARSE NULL, |
| datetime251 | datetime | SPARSE NULL, |
| datetime252 | datetime | SPARSE NULL, |
| datetime253 | datetime | SPARSE NULL, |
| datetime254 | datetime | SPARSE NULL, |
| datetime255 | datetime | SPARSE NULL, |
| datetime256 | datetime | SPARSE NULL, |
| datetime257 | datetime | SPARSE NULL, |
| datetime258 | datetime | SPARSE NULL, |
| datetime259 | datetime | SPARSE NULL, |
| datetime260 | datetime | SPARSE NULL, |
| datetime261 | datetime | SPARSE NULL, |
| datetime262 | datetime | SPARSE NULL, |
| datetime263 | datetime | SPARSE NULL, |
| datetime264 | datetime | SPARSE NULL, |
| datetime265 | datetime | SPARSE NULL, |
| datetime266 | datetime | SPARSE NULL, |
| datetime267 | datetime | SPARSE NULL, |
| datetime268 | datetime | SPARSE NULL, |
| datetime269 | datetime | SPARSE NULL, |
| datetime270 | datetime | SPARSE NULL, |
| datetime271 | datetime | SPARSE NULL, |
| datetime272 | datetime | SPARSE NULL, |
| datetime273 | datetime | SPARSE NULL, |
| datetime274 | datetime | SPARSE NULL, |
| datetime275 | datetime | SPARSE NULL, |
| datetime276 | datetime | SPARSE NULL, |
| datetime277 | datetime | SPARSE NULL, |
| datetime278 | datetime | SPARSE NULL, |

| | | |
|-------------|----------|--------------|
| datetime279 | datetime | SPARSE NULL, |
| datetime280 | datetime | SPARSE NULL, |
| datetime281 | datetime | SPARSE NULL, |
| datetime282 | datetime | SPARSE NULL, |
| datetime283 | datetime | SPARSE NULL, |
| datetime284 | datetime | SPARSE NULL, |
| datetime285 | datetime | SPARSE NULL, |
| datetime286 | datetime | SPARSE NULL, |
| datetime287 | datetime | SPARSE NULL, |
| datetime288 | datetime | SPARSE NULL, |
| datetime289 | datetime | SPARSE NULL, |
| datetime290 | datetime | SPARSE NULL, |
| datetime291 | datetime | SPARSE NULL, |
| datetime292 | datetime | SPARSE NULL, |
| datetime293 | datetime | SPARSE NULL, |
| datetime294 | datetime | SPARSE NULL, |
| datetime295 | datetime | SPARSE NULL, |
| datetime296 | datetime | SPARSE NULL, |
| datetime297 | datetime | SPARSE NULL, |
| datetime298 | datetime | SPARSE NULL, |
| datetime299 | datetime | SPARSE NULL, |
| datetime300 | datetime | SPARSE NULL, |
| datetime301 | datetime | SPARSE NULL, |
| datetime302 | datetime | SPARSE NULL, |
| datetime303 | datetime | SPARSE NULL, |
| datetime304 | datetime | SPARSE NULL, |
| datetime305 | datetime | SPARSE NULL, |
| datetime306 | datetime | SPARSE NULL, |
| datetime307 | datetime | SPARSE NULL, |
| datetime308 | datetime | SPARSE NULL, |
| datetime309 | datetime | SPARSE NULL, |
| datetime310 | datetime | SPARSE NULL, |
| datetime311 | datetime | SPARSE NULL, |
| datetime312 | datetime | SPARSE NULL, |
| datetime313 | datetime | SPARSE NULL, |
| datetime314 | datetime | SPARSE NULL, |
| datetime315 | datetime | SPARSE NULL, |
| datetime316 | datetime | SPARSE NULL, |
| datetime317 | datetime | SPARSE NULL, |
| datetime318 | datetime | SPARSE NULL, |
| datetime319 | datetime | SPARSE NULL, |
| datetime320 | datetime | SPARSE NULL, |
| datetime321 | datetime | SPARSE NULL, |
| datetime322 | datetime | SPARSE NULL, |
| datetime323 | datetime | SPARSE NULL, |
| datetime324 | datetime | SPARSE NULL, |
| datetime325 | datetime | SPARSE NULL, |
| datetime326 | datetime | SPARSE NULL, |
| datetime327 | datetime | SPARSE NULL, |
| datetime328 | datetime | SPARSE NULL, |
| datetime329 | datetime | SPARSE NULL, |
| datetime330 | datetime | SPARSE NULL, |
| datetime331 | datetime | SPARSE NULL, |
| datetime332 | datetime | SPARSE NULL, |
| datetime333 | datetime | SPARSE NULL, |
| datetime334 | datetime | SPARSE NULL, |
| datetime335 | datetime | SPARSE NULL, |
| datetime336 | datetime | SPARSE NULL, |
| datetime337 | datetime | SPARSE NULL, |

| | | |
|-------------|----------|--------------|
| datetime338 | datetime | SPARSE NULL, |
| datetime339 | datetime | SPARSE NULL, |
| datetime340 | datetime | SPARSE NULL, |
| datetime341 | datetime | SPARSE NULL, |
| datetime342 | datetime | SPARSE NULL, |
| datetime343 | datetime | SPARSE NULL, |
| datetime344 | datetime | SPARSE NULL, |
| datetime345 | datetime | SPARSE NULL, |
| datetime346 | datetime | SPARSE NULL, |
| datetime347 | datetime | SPARSE NULL, |
| datetime348 | datetime | SPARSE NULL, |
| datetime349 | datetime | SPARSE NULL, |
| datetime350 | datetime | SPARSE NULL, |
| datetime351 | datetime | SPARSE NULL, |
| datetime352 | datetime | SPARSE NULL, |
| datetime353 | datetime | SPARSE NULL, |
| datetime354 | datetime | SPARSE NULL, |
| datetime355 | datetime | SPARSE NULL, |
| datetime356 | datetime | SPARSE NULL, |
| datetime357 | datetime | SPARSE NULL, |
| datetime358 | datetime | SPARSE NULL, |
| datetime359 | datetime | SPARSE NULL, |
| datetime360 | datetime | SPARSE NULL, |
| datetime361 | datetime | SPARSE NULL, |
| datetime362 | datetime | SPARSE NULL, |
| datetime363 | datetime | SPARSE NULL, |
| datetime364 | datetime | SPARSE NULL, |
| datetime365 | datetime | SPARSE NULL, |
| datetime366 | datetime | SPARSE NULL, |
| datetime367 | datetime | SPARSE NULL, |
| datetime368 | datetime | SPARSE NULL, |
| datetime369 | datetime | SPARSE NULL, |
| datetime370 | datetime | SPARSE NULL, |
| datetime371 | datetime | SPARSE NULL, |
| datetime372 | datetime | SPARSE NULL, |
| datetime373 | datetime | SPARSE NULL, |
| datetime374 | datetime | SPARSE NULL, |
| datetime375 | datetime | SPARSE NULL, |
| datetime376 | datetime | SPARSE NULL, |
| datetime377 | datetime | SPARSE NULL, |
| datetime378 | datetime | SPARSE NULL, |
| datetime379 | datetime | SPARSE NULL, |
| datetime380 | datetime | SPARSE NULL, |
| datetime381 | datetime | SPARSE NULL, |
| datetime382 | datetime | SPARSE NULL, |
| datetime383 | datetime | SPARSE NULL, |
| datetime384 | datetime | SPARSE NULL, |
| datetime385 | datetime | SPARSE NULL, |
| datetime386 | datetime | SPARSE NULL, |
| datetime387 | datetime | SPARSE NULL, |
| datetime388 | datetime | SPARSE NULL, |
| datetime389 | datetime | SPARSE NULL, |
| datetime390 | datetime | SPARSE NULL, |
| datetime391 | datetime | SPARSE NULL, |
| datetime392 | datetime | SPARSE NULL, |
| datetime393 | datetime | SPARSE NULL, |
| datetime394 | datetime | SPARSE NULL, |
| datetime395 | datetime | SPARSE NULL, |
| datetime396 | datetime | SPARSE NULL, |

| | | |
|-------------|----------|--------------|
| datetime397 | datetime | SPARSE NULL, |
| datetime398 | datetime | SPARSE NULL, |
| datetime399 | datetime | SPARSE NULL, |
| datetime400 | datetime | SPARSE NULL, |
| datetime401 | datetime | SPARSE NULL, |
| datetime402 | datetime | SPARSE NULL, |
| datetime403 | datetime | SPARSE NULL, |
| datetime404 | datetime | SPARSE NULL, |
| datetime405 | datetime | SPARSE NULL, |
| datetime406 | datetime | SPARSE NULL, |
| datetime407 | datetime | SPARSE NULL, |
| datetime408 | datetime | SPARSE NULL, |
| datetime409 | datetime | SPARSE NULL, |
| datetime410 | datetime | SPARSE NULL, |
| datetime411 | datetime | SPARSE NULL, |
| datetime412 | datetime | SPARSE NULL, |
| datetime413 | datetime | SPARSE NULL, |
| datetime414 | datetime | SPARSE NULL, |
| datetime415 | datetime | SPARSE NULL, |
| datetime416 | datetime | SPARSE NULL, |
| datetime417 | datetime | SPARSE NULL, |
| datetime418 | datetime | SPARSE NULL, |
| datetime419 | datetime | SPARSE NULL, |
| datetime420 | datetime | SPARSE NULL, |
| datetime421 | datetime | SPARSE NULL, |
| datetime422 | datetime | SPARSE NULL, |
| datetime423 | datetime | SPARSE NULL, |
| datetime424 | datetime | SPARSE NULL, |
| datetime425 | datetime | SPARSE NULL, |
| datetime426 | datetime | SPARSE NULL, |
| datetime427 | datetime | SPARSE NULL, |
| datetime428 | datetime | SPARSE NULL, |
| datetime429 | datetime | SPARSE NULL, |
| datetime430 | datetime | SPARSE NULL, |
| datetime431 | datetime | SPARSE NULL, |
| datetime432 | datetime | SPARSE NULL, |
| datetime433 | datetime | SPARSE NULL, |
| datetime434 | datetime | SPARSE NULL, |
| datetime435 | datetime | SPARSE NULL, |
| datetime436 | datetime | SPARSE NULL, |
| datetime437 | datetime | SPARSE NULL, |
| datetime438 | datetime | SPARSE NULL, |
| datetime439 | datetime | SPARSE NULL, |
| datetime440 | datetime | SPARSE NULL, |
| datetime441 | datetime | SPARSE NULL, |
| datetime442 | datetime | SPARSE NULL, |
| datetime443 | datetime | SPARSE NULL, |
| datetime444 | datetime | SPARSE NULL, |
| datetime445 | datetime | SPARSE NULL, |
| datetime446 | datetime | SPARSE NULL, |
| datetime447 | datetime | SPARSE NULL, |
| datetime448 | datetime | SPARSE NULL, |
| datetime449 | datetime | SPARSE NULL, |
| datetime450 | datetime | SPARSE NULL, |
| datetime451 | datetime | SPARSE NULL, |
| datetime452 | datetime | SPARSE NULL, |
| datetime453 | datetime | SPARSE NULL, |
| datetime454 | datetime | SPARSE NULL, |
| datetime455 | datetime | SPARSE NULL, |

| | | |
|-------------|----------|--------------|
| datetime456 | datetime | SPARSE NULL, |
| datetime457 | datetime | SPARSE NULL, |
| datetime458 | datetime | SPARSE NULL, |
| datetime459 | datetime | SPARSE NULL, |
| datetime460 | datetime | SPARSE NULL, |
| datetime461 | datetime | SPARSE NULL, |
| datetime462 | datetime | SPARSE NULL, |
| datetime463 | datetime | SPARSE NULL, |
| datetime464 | datetime | SPARSE NULL, |
| datetime465 | datetime | SPARSE NULL, |
| datetime466 | datetime | SPARSE NULL, |
| datetime467 | datetime | SPARSE NULL, |
| datetime468 | datetime | SPARSE NULL, |
| datetime469 | datetime | SPARSE NULL, |
| datetime470 | datetime | SPARSE NULL, |
| datetime471 | datetime | SPARSE NULL, |
| datetime472 | datetime | SPARSE NULL, |
| datetime473 | datetime | SPARSE NULL, |
| datetime474 | datetime | SPARSE NULL, |
| datetime475 | datetime | SPARSE NULL, |
| datetime476 | datetime | SPARSE NULL, |
| datetime477 | datetime | SPARSE NULL, |
| datetime478 | datetime | SPARSE NULL, |
| datetime479 | datetime | SPARSE NULL, |
| datetime480 | datetime | SPARSE NULL, |
| datetime481 | datetime | SPARSE NULL, |
| datetime482 | datetime | SPARSE NULL, |
| datetime483 | datetime | SPARSE NULL, |
| datetime484 | datetime | SPARSE NULL, |
| datetime485 | datetime | SPARSE NULL, |
| datetime486 | datetime | SPARSE NULL, |
| datetime487 | datetime | SPARSE NULL, |
| datetime488 | datetime | SPARSE NULL, |
| datetime489 | datetime | SPARSE NULL, |
| datetime490 | datetime | SPARSE NULL, |
| datetime491 | datetime | SPARSE NULL, |
| datetime492 | datetime | SPARSE NULL, |
| datetime493 | datetime | SPARSE NULL, |
| datetime494 | datetime | SPARSE NULL, |
| datetime495 | datetime | SPARSE NULL, |
| datetime496 | datetime | SPARSE NULL, |
| datetime497 | datetime | SPARSE NULL, |
| datetime498 | datetime | SPARSE NULL, |
| datetime499 | datetime | SPARSE NULL, |
| datetime500 | datetime | SPARSE NULL, |
| datetime501 | datetime | SPARSE NULL, |
| datetime502 | datetime | SPARSE NULL, |
| datetime503 | datetime | SPARSE NULL, |
| datetime504 | datetime | SPARSE NULL, |
| datetime505 | datetime | SPARSE NULL, |
| datetime506 | datetime | SPARSE NULL, |
| datetime507 | datetime | SPARSE NULL, |
| datetime508 | datetime | SPARSE NULL, |
| datetime509 | datetime | SPARSE NULL, |
| datetime510 | datetime | SPARSE NULL, |
| datetime511 | datetime | SPARSE NULL, |
| datetime512 | datetime | SPARSE NULL, |
| datetime513 | datetime | SPARSE NULL, |
| datetime514 | datetime | SPARSE NULL, |

| | | |
|-------------|----------|--------------|
| datetime515 | datetime | SPARSE NULL, |
| datetime516 | datetime | SPARSE NULL, |
| datetime517 | datetime | SPARSE NULL, |
| datetime518 | datetime | SPARSE NULL, |
| datetime519 | datetime | SPARSE NULL, |
| datetime520 | datetime | SPARSE NULL, |
| datetime521 | datetime | SPARSE NULL, |
| datetime522 | datetime | SPARSE NULL, |
| datetime523 | datetime | SPARSE NULL, |
| datetime524 | datetime | SPARSE NULL, |
| datetime525 | datetime | SPARSE NULL, |
| datetime526 | datetime | SPARSE NULL, |
| datetime527 | datetime | SPARSE NULL, |
| datetime528 | datetime | SPARSE NULL, |
| datetime529 | datetime | SPARSE NULL, |
| datetime530 | datetime | SPARSE NULL, |
| datetime531 | datetime | SPARSE NULL, |
| datetime532 | datetime | SPARSE NULL, |
| datetime533 | datetime | SPARSE NULL, |
| datetime534 | datetime | SPARSE NULL, |
| datetime535 | datetime | SPARSE NULL, |
| datetime536 | datetime | SPARSE NULL, |
| datetime537 | datetime | SPARSE NULL, |
| datetime538 | datetime | SPARSE NULL, |
| datetime539 | datetime | SPARSE NULL, |
| datetime540 | datetime | SPARSE NULL, |
| datetime541 | datetime | SPARSE NULL, |
| datetime542 | datetime | SPARSE NULL, |
| datetime543 | datetime | SPARSE NULL, |
| datetime544 | datetime | SPARSE NULL, |
| datetime545 | datetime | SPARSE NULL, |
| datetime546 | datetime | SPARSE NULL, |
| datetime547 | datetime | SPARSE NULL, |
| datetime548 | datetime | SPARSE NULL, |
| datetime549 | datetime | SPARSE NULL, |
| datetime550 | datetime | SPARSE NULL, |
| float1 | float | SPARSE NULL, |
| float2 | float | SPARSE NULL, |
| float3 | float | SPARSE NULL, |
| float4 | float | SPARSE NULL, |
| float5 | float | SPARSE NULL, |
| float6 | float | SPARSE NULL, |
| float7 | float | SPARSE NULL, |
| float8 | float | SPARSE NULL, |
| float9 | float | SPARSE NULL, |
| float10 | float | SPARSE NULL, |
| float11 | float | SPARSE NULL, |
| float12 | float | SPARSE NULL, |
| float13 | float | SPARSE NULL, |
| float14 | float | SPARSE NULL, |
| float15 | float | SPARSE NULL, |
| float16 | float | SPARSE NULL, |
| float17 | float | SPARSE NULL, |
| float18 | float | SPARSE NULL, |
| float19 | float | SPARSE NULL, |
| float20 | float | SPARSE NULL, |
| float21 | float | SPARSE NULL, |
| float22 | float | SPARSE NULL, |
| float23 | float | SPARSE NULL, |

| | | |
|---------|-------|--------------|
| float24 | float | SPARSE NULL, |
| float25 | float | SPARSE NULL, |
| float26 | float | SPARSE NULL, |
| float27 | float | SPARSE NULL, |
| float28 | float | SPARSE NULL, |
| float29 | float | SPARSE NULL, |
| float30 | float | SPARSE NULL, |
| float31 | float | SPARSE NULL, |
| float32 | float | SPARSE NULL, |
| float33 | float | SPARSE NULL, |
| float34 | float | SPARSE NULL, |
| float35 | float | SPARSE NULL, |
| float36 | float | SPARSE NULL, |
| float37 | float | SPARSE NULL, |
| float38 | float | SPARSE NULL, |
| float39 | float | SPARSE NULL, |
| float40 | float | SPARSE NULL, |
| float41 | float | SPARSE NULL, |
| float42 | float | SPARSE NULL, |
| float43 | float | SPARSE NULL, |
| float44 | float | SPARSE NULL, |
| float45 | float | SPARSE NULL, |
| float46 | float | SPARSE NULL, |
| float47 | float | SPARSE NULL, |
| float48 | float | SPARSE NULL, |
| float49 | float | SPARSE NULL, |
| float50 | float | SPARSE NULL, |
| float51 | float | SPARSE NULL, |
| float52 | float | SPARSE NULL, |
| float53 | float | SPARSE NULL, |
| float54 | float | SPARSE NULL, |
| float55 | float | SPARSE NULL, |
| float56 | float | SPARSE NULL, |
| float57 | float | SPARSE NULL, |
| float58 | float | SPARSE NULL, |
| float59 | float | SPARSE NULL, |
| float60 | float | SPARSE NULL, |
| float61 | float | SPARSE NULL, |
| float62 | float | SPARSE NULL, |
| float63 | float | SPARSE NULL, |
| float64 | float | SPARSE NULL, |
| float65 | float | SPARSE NULL, |
| float66 | float | SPARSE NULL, |
| float67 | float | SPARSE NULL, |
| float68 | float | SPARSE NULL, |
| float69 | float | SPARSE NULL, |
| float70 | float | SPARSE NULL, |
| float71 | float | SPARSE NULL, |
| float72 | float | SPARSE NULL, |
| float73 | float | SPARSE NULL, |
| float74 | float | SPARSE NULL, |
| float75 | float | SPARSE NULL, |
| float76 | float | SPARSE NULL, |
| float77 | float | SPARSE NULL, |
| float78 | float | SPARSE NULL, |
| float79 | float | SPARSE NULL, |
| float80 | float | SPARSE NULL, |
| float81 | float | SPARSE NULL, |
| float82 | float | SPARSE NULL, |

| | | |
|----------|-------|--------------|
| float83 | float | SPARSE NULL, |
| float84 | float | SPARSE NULL, |
| float85 | float | SPARSE NULL, |
| float86 | float | SPARSE NULL, |
| float87 | float | SPARSE NULL, |
| float88 | float | SPARSE NULL, |
| float89 | float | SPARSE NULL, |
| float90 | float | SPARSE NULL, |
| float91 | float | SPARSE NULL, |
| float92 | float | SPARSE NULL, |
| float93 | float | SPARSE NULL, |
| float94 | float | SPARSE NULL, |
| float95 | float | SPARSE NULL, |
| float96 | float | SPARSE NULL, |
| float97 | float | SPARSE NULL, |
| float98 | float | SPARSE NULL, |
| float99 | float | SPARSE NULL, |
| float100 | float | SPARSE NULL, |
| float101 | float | SPARSE NULL, |
| float102 | float | SPARSE NULL, |
| float103 | float | SPARSE NULL, |
| float104 | float | SPARSE NULL, |
| float105 | float | SPARSE NULL, |
| float106 | float | SPARSE NULL, |
| float107 | float | SPARSE NULL, |
| float108 | float | SPARSE NULL, |
| float109 | float | SPARSE NULL, |
| float110 | float | SPARSE NULL, |
| float111 | float | SPARSE NULL, |
| float112 | float | SPARSE NULL, |
| float113 | float | SPARSE NULL, |
| float114 | float | SPARSE NULL, |
| float115 | float | SPARSE NULL, |
| float116 | float | SPARSE NULL, |
| float117 | float | SPARSE NULL, |
| float118 | float | SPARSE NULL, |
| float119 | float | SPARSE NULL, |
| float120 | float | SPARSE NULL, |
| float121 | float | SPARSE NULL, |
| float122 | float | SPARSE NULL, |
| float123 | float | SPARSE NULL, |
| float124 | float | SPARSE NULL, |
| float125 | float | SPARSE NULL, |
| float126 | float | SPARSE NULL, |
| float127 | float | SPARSE NULL, |
| float128 | float | SPARSE NULL, |
| float129 | float | SPARSE NULL, |
| float130 | float | SPARSE NULL, |
| float131 | float | SPARSE NULL, |
| float132 | float | SPARSE NULL, |
| float133 | float | SPARSE NULL, |
| float134 | float | SPARSE NULL, |
| float135 | float | SPARSE NULL, |
| float136 | float | SPARSE NULL, |
| float137 | float | SPARSE NULL, |
| float138 | float | SPARSE NULL, |
| float139 | float | SPARSE NULL, |
| float140 | float | SPARSE NULL, |
| float141 | float | SPARSE NULL, |

| | | |
|----------|-------|--------------|
| float142 | float | SPARSE NULL, |
| float143 | float | SPARSE NULL, |
| float144 | float | SPARSE NULL, |
| float145 | float | SPARSE NULL, |
| float146 | float | SPARSE NULL, |
| float147 | float | SPARSE NULL, |
| float148 | float | SPARSE NULL, |
| float149 | float | SPARSE NULL, |
| float150 | float | SPARSE NULL, |
| float151 | float | SPARSE NULL, |
| float152 | float | SPARSE NULL, |
| float153 | float | SPARSE NULL, |
| float154 | float | SPARSE NULL, |
| float155 | float | SPARSE NULL, |
| float156 | float | SPARSE NULL, |
| float157 | float | SPARSE NULL, |
| float158 | float | SPARSE NULL, |
| float159 | float | SPARSE NULL, |
| float160 | float | SPARSE NULL, |
| float161 | float | SPARSE NULL, |
| float162 | float | SPARSE NULL, |
| float163 | float | SPARSE NULL, |
| float164 | float | SPARSE NULL, |
| float165 | float | SPARSE NULL, |
| float166 | float | SPARSE NULL, |
| float167 | float | SPARSE NULL, |
| float168 | float | SPARSE NULL, |
| float169 | float | SPARSE NULL, |
| float170 | float | SPARSE NULL, |
| float171 | float | SPARSE NULL, |
| float172 | float | SPARSE NULL, |
| float173 | float | SPARSE NULL, |
| float174 | float | SPARSE NULL, |
| float175 | float | SPARSE NULL, |
| float176 | float | SPARSE NULL, |
| float177 | float | SPARSE NULL, |
| float178 | float | SPARSE NULL, |
| float179 | float | SPARSE NULL, |
| float180 | float | SPARSE NULL, |
| float181 | float | SPARSE NULL, |
| float182 | float | SPARSE NULL, |
| float183 | float | SPARSE NULL, |
| float184 | float | SPARSE NULL, |
| float185 | float | SPARSE NULL, |
| float186 | float | SPARSE NULL, |
| float187 | float | SPARSE NULL, |
| float188 | float | SPARSE NULL, |
| float189 | float | SPARSE NULL, |
| float190 | float | SPARSE NULL, |
| float191 | float | SPARSE NULL, |
| float192 | float | SPARSE NULL, |
| float193 | float | SPARSE NULL, |
| float194 | float | SPARSE NULL, |
| float195 | float | SPARSE NULL, |
| float196 | float | SPARSE NULL, |
| float197 | float | SPARSE NULL, |
| float198 | float | SPARSE NULL, |
| float199 | float | SPARSE NULL, |
| float200 | float | SPARSE NULL, |

| | | |
|----------|-------|--------------|
| float201 | float | SPARSE NULL, |
| float202 | float | SPARSE NULL, |
| float203 | float | SPARSE NULL, |
| float204 | float | SPARSE NULL, |
| float205 | float | SPARSE NULL, |
| float206 | float | SPARSE NULL, |
| float207 | float | SPARSE NULL, |
| float208 | float | SPARSE NULL, |
| float209 | float | SPARSE NULL, |
| float210 | float | SPARSE NULL, |
| float211 | float | SPARSE NULL, |
| float212 | float | SPARSE NULL, |
| float213 | float | SPARSE NULL, |
| float214 | float | SPARSE NULL, |
| float215 | float | SPARSE NULL, |
| float216 | float | SPARSE NULL, |
| float217 | float | SPARSE NULL, |
| float218 | float | SPARSE NULL, |
| float219 | float | SPARSE NULL, |
| float220 | float | SPARSE NULL, |
| float221 | float | SPARSE NULL, |
| float222 | float | SPARSE NULL, |
| float223 | float | SPARSE NULL, |
| float224 | float | SPARSE NULL, |
| float225 | float | SPARSE NULL, |
| float226 | float | SPARSE NULL, |
| float227 | float | SPARSE NULL, |
| float228 | float | SPARSE NULL, |
| float229 | float | SPARSE NULL, |
| float230 | float | SPARSE NULL, |
| float231 | float | SPARSE NULL, |
| float232 | float | SPARSE NULL, |
| float233 | float | SPARSE NULL, |
| float234 | float | SPARSE NULL, |
| float235 | float | SPARSE NULL, |
| float236 | float | SPARSE NULL, |
| float237 | float | SPARSE NULL, |
| float238 | float | SPARSE NULL, |
| float239 | float | SPARSE NULL, |
| float240 | float | SPARSE NULL, |
| float241 | float | SPARSE NULL, |
| float242 | float | SPARSE NULL, |
| float243 | float | SPARSE NULL, |
| float244 | float | SPARSE NULL, |
| float245 | float | SPARSE NULL, |
| float246 | float | SPARSE NULL, |
| float247 | float | SPARSE NULL, |
| float248 | float | SPARSE NULL, |
| float249 | float | SPARSE NULL, |
| float250 | float | SPARSE NULL, |
| float251 | float | SPARSE NULL, |
| float252 | float | SPARSE NULL, |
| float253 | float | SPARSE NULL, |
| float254 | float | SPARSE NULL, |
| float255 | float | SPARSE NULL, |
| float256 | float | SPARSE NULL, |
| float257 | float | SPARSE NULL, |
| float258 | float | SPARSE NULL, |
| float259 | float | SPARSE NULL, |

| | | |
|----------|-------|--------------|
| float260 | float | SPARSE NULL, |
| float261 | float | SPARSE NULL, |
| float262 | float | SPARSE NULL, |
| float263 | float | SPARSE NULL, |
| float264 | float | SPARSE NULL, |
| float265 | float | SPARSE NULL, |
| float266 | float | SPARSE NULL, |
| float267 | float | SPARSE NULL, |
| float268 | float | SPARSE NULL, |
| float269 | float | SPARSE NULL, |
| float270 | float | SPARSE NULL, |
| float271 | float | SPARSE NULL, |
| float272 | float | SPARSE NULL, |
| float273 | float | SPARSE NULL, |
| float274 | float | SPARSE NULL, |
| float275 | float | SPARSE NULL, |
| float276 | float | SPARSE NULL, |
| float277 | float | SPARSE NULL, |
| float278 | float | SPARSE NULL, |
| float279 | float | SPARSE NULL, |
| float280 | float | SPARSE NULL, |
| float281 | float | SPARSE NULL, |
| float282 | float | SPARSE NULL, |
| float283 | float | SPARSE NULL, |
| float284 | float | SPARSE NULL, |
| float285 | float | SPARSE NULL, |
| float286 | float | SPARSE NULL, |
| float287 | float | SPARSE NULL, |
| float288 | float | SPARSE NULL, |
| float289 | float | SPARSE NULL, |
| float290 | float | SPARSE NULL, |
| float291 | float | SPARSE NULL, |
| float292 | float | SPARSE NULL, |
| float293 | float | SPARSE NULL, |
| float294 | float | SPARSE NULL, |
| float295 | float | SPARSE NULL, |
| float296 | float | SPARSE NULL, |
| float297 | float | SPARSE NULL, |
| float298 | float | SPARSE NULL, |
| float299 | float | SPARSE NULL, |
| float300 | float | SPARSE NULL, |
| float301 | float | SPARSE NULL, |
| float302 | float | SPARSE NULL, |
| float303 | float | SPARSE NULL, |
| float304 | float | SPARSE NULL, |
| float305 | float | SPARSE NULL, |
| float306 | float | SPARSE NULL, |
| float307 | float | SPARSE NULL, |
| float308 | float | SPARSE NULL, |
| float309 | float | SPARSE NULL, |
| float310 | float | SPARSE NULL, |
| float311 | float | SPARSE NULL, |
| float312 | float | SPARSE NULL, |
| float313 | float | SPARSE NULL, |
| float314 | float | SPARSE NULL, |
| float315 | float | SPARSE NULL, |
| float316 | float | SPARSE NULL, |
| float317 | float | SPARSE NULL, |
| float318 | float | SPARSE NULL, |

| | | |
|----------|-------|--------------|
| float319 | float | SPARSE NULL, |
| float320 | float | SPARSE NULL, |
| float321 | float | SPARSE NULL, |
| float322 | float | SPARSE NULL, |
| float323 | float | SPARSE NULL, |
| float324 | float | SPARSE NULL, |
| float325 | float | SPARSE NULL, |
| float326 | float | SPARSE NULL, |
| float327 | float | SPARSE NULL, |
| float328 | float | SPARSE NULL, |
| float329 | float | SPARSE NULL, |
| float330 | float | SPARSE NULL, |
| float331 | float | SPARSE NULL, |
| float332 | float | SPARSE NULL, |
| float333 | float | SPARSE NULL, |
| float334 | float | SPARSE NULL, |
| float335 | float | SPARSE NULL, |
| float336 | float | SPARSE NULL, |
| float337 | float | SPARSE NULL, |
| float338 | float | SPARSE NULL, |
| float339 | float | SPARSE NULL, |
| float340 | float | SPARSE NULL, |
| float341 | float | SPARSE NULL, |
| float342 | float | SPARSE NULL, |
| float343 | float | SPARSE NULL, |
| float344 | float | SPARSE NULL, |
| float345 | float | SPARSE NULL, |
| float346 | float | SPARSE NULL, |
| float347 | float | SPARSE NULL, |
| float348 | float | SPARSE NULL, |
| float349 | float | SPARSE NULL, |
| float350 | float | SPARSE NULL, |
| float351 | float | SPARSE NULL, |
| float352 | float | SPARSE NULL, |
| float353 | float | SPARSE NULL, |
| float354 | float | SPARSE NULL, |
| float355 | float | SPARSE NULL, |
| float356 | float | SPARSE NULL, |
| float357 | float | SPARSE NULL, |
| float358 | float | SPARSE NULL, |
| float359 | float | SPARSE NULL, |
| float360 | float | SPARSE NULL, |
| float361 | float | SPARSE NULL, |
| float362 | float | SPARSE NULL, |
| float363 | float | SPARSE NULL, |
| float364 | float | SPARSE NULL, |
| float365 | float | SPARSE NULL, |
| float366 | float | SPARSE NULL, |
| float367 | float | SPARSE NULL, |
| float368 | float | SPARSE NULL, |
| float369 | float | SPARSE NULL, |
| float370 | float | SPARSE NULL, |
| float371 | float | SPARSE NULL, |
| float372 | float | SPARSE NULL, |
| float373 | float | SPARSE NULL, |
| float374 | float | SPARSE NULL, |
| float375 | float | SPARSE NULL, |
| float376 | float | SPARSE NULL, |
| float377 | float | SPARSE NULL, |

| | | |
|----------|-------|--------------|
| float378 | float | SPARSE NULL, |
| float379 | float | SPARSE NULL, |
| float380 | float | SPARSE NULL, |
| float381 | float | SPARSE NULL, |
| float382 | float | SPARSE NULL, |
| float383 | float | SPARSE NULL, |
| float384 | float | SPARSE NULL, |
| float385 | float | SPARSE NULL, |
| float386 | float | SPARSE NULL, |
| float387 | float | SPARSE NULL, |
| float388 | float | SPARSE NULL, |
| float389 | float | SPARSE NULL, |
| float390 | float | SPARSE NULL, |
| float391 | float | SPARSE NULL, |
| float392 | float | SPARSE NULL, |
| float393 | float | SPARSE NULL, |
| float394 | float | SPARSE NULL, |
| float395 | float | SPARSE NULL, |
| float396 | float | SPARSE NULL, |
| float397 | float | SPARSE NULL, |
| float398 | float | SPARSE NULL, |
| float399 | float | SPARSE NULL, |
| float400 | float | SPARSE NULL, |
| float401 | float | SPARSE NULL, |
| float402 | float | SPARSE NULL, |
| float403 | float | SPARSE NULL, |
| float404 | float | SPARSE NULL, |
| float405 | float | SPARSE NULL, |
| float406 | float | SPARSE NULL, |
| float407 | float | SPARSE NULL, |
| float408 | float | SPARSE NULL, |
| float409 | float | SPARSE NULL, |
| float410 | float | SPARSE NULL, |
| float411 | float | SPARSE NULL, |
| float412 | float | SPARSE NULL, |
| float413 | float | SPARSE NULL, |
| float414 | float | SPARSE NULL, |
| float415 | float | SPARSE NULL, |
| float416 | float | SPARSE NULL, |
| float417 | float | SPARSE NULL, |
| float418 | float | SPARSE NULL, |
| float419 | float | SPARSE NULL, |
| float420 | float | SPARSE NULL, |
| float421 | float | SPARSE NULL, |
| float422 | float | SPARSE NULL, |
| float423 | float | SPARSE NULL, |
| float424 | float | SPARSE NULL, |
| float425 | float | SPARSE NULL, |
| float426 | float | SPARSE NULL, |
| float427 | float | SPARSE NULL, |
| float428 | float | SPARSE NULL, |
| float429 | float | SPARSE NULL, |
| float430 | float | SPARSE NULL, |
| float431 | float | SPARSE NULL, |
| float432 | float | SPARSE NULL, |
| float433 | float | SPARSE NULL, |
| float434 | float | SPARSE NULL, |
| float435 | float | SPARSE NULL, |
| float436 | float | SPARSE NULL, |

| | | |
|----------|-------|--------------|
| float437 | float | SPARSE NULL, |
| float438 | float | SPARSE NULL, |
| float439 | float | SPARSE NULL, |
| float440 | float | SPARSE NULL, |
| float441 | float | SPARSE NULL, |
| float442 | float | SPARSE NULL, |
| float443 | float | SPARSE NULL, |
| float444 | float | SPARSE NULL, |
| float445 | float | SPARSE NULL, |
| float446 | float | SPARSE NULL, |
| float447 | float | SPARSE NULL, |
| float448 | float | SPARSE NULL, |
| float449 | float | SPARSE NULL, |
| float450 | float | SPARSE NULL, |
| float451 | float | SPARSE NULL, |
| float452 | float | SPARSE NULL, |
| float453 | float | SPARSE NULL, |
| float454 | float | SPARSE NULL, |
| float455 | float | SPARSE NULL, |
| float456 | float | SPARSE NULL, |
| float457 | float | SPARSE NULL, |
| float458 | float | SPARSE NULL, |
| float459 | float | SPARSE NULL, |
| float460 | float | SPARSE NULL, |
| float461 | float | SPARSE NULL, |
| float462 | float | SPARSE NULL, |
| float463 | float | SPARSE NULL, |
| float464 | float | SPARSE NULL, |
| float465 | float | SPARSE NULL, |
| float466 | float | SPARSE NULL, |
| float467 | float | SPARSE NULL, |
| float468 | float | SPARSE NULL, |
| float469 | float | SPARSE NULL, |
| float470 | float | SPARSE NULL, |
| float471 | float | SPARSE NULL, |
| float472 | float | SPARSE NULL, |
| float473 | float | SPARSE NULL, |
| float474 | float | SPARSE NULL, |
| float475 | float | SPARSE NULL, |
| float476 | float | SPARSE NULL, |
| float477 | float | SPARSE NULL, |
| float478 | float | SPARSE NULL, |
| float479 | float | SPARSE NULL, |
| float480 | float | SPARSE NULL, |
| float481 | float | SPARSE NULL, |
| float482 | float | SPARSE NULL, |
| float483 | float | SPARSE NULL, |
| float484 | float | SPARSE NULL, |
| float485 | float | SPARSE NULL, |
| float486 | float | SPARSE NULL, |
| float487 | float | SPARSE NULL, |
| float488 | float | SPARSE NULL, |
| float489 | float | SPARSE NULL, |
| float490 | float | SPARSE NULL, |
| float491 | float | SPARSE NULL, |
| float492 | float | SPARSE NULL, |
| float493 | float | SPARSE NULL, |
| float494 | float | SPARSE NULL, |
| float495 | float | SPARSE NULL, |

| | | |
|----------|-------|--------------|
| float496 | float | SPARSE NULL, |
| float497 | float | SPARSE NULL, |
| float498 | float | SPARSE NULL, |
| float499 | float | SPARSE NULL, |
| float500 | float | SPARSE NULL, |
| float501 | float | SPARSE NULL, |
| float502 | float | SPARSE NULL, |
| float503 | float | SPARSE NULL, |
| float504 | float | SPARSE NULL, |
| float505 | float | SPARSE NULL, |
| float506 | float | SPARSE NULL, |
| float507 | float | SPARSE NULL, |
| float508 | float | SPARSE NULL, |
| float509 | float | SPARSE NULL, |
| float510 | float | SPARSE NULL, |
| float511 | float | SPARSE NULL, |
| float512 | float | SPARSE NULL, |
| float513 | float | SPARSE NULL, |
| float514 | float | SPARSE NULL, |
| float515 | float | SPARSE NULL, |
| float516 | float | SPARSE NULL, |
| float517 | float | SPARSE NULL, |
| float518 | float | SPARSE NULL, |
| float519 | float | SPARSE NULL, |
| float520 | float | SPARSE NULL, |
| float521 | float | SPARSE NULL, |
| float522 | float | SPARSE NULL, |
| float523 | float | SPARSE NULL, |
| float524 | float | SPARSE NULL, |
| float525 | float | SPARSE NULL, |
| float526 | float | SPARSE NULL, |
| float527 | float | SPARSE NULL, |
| float528 | float | SPARSE NULL, |
| float529 | float | SPARSE NULL, |
| float530 | float | SPARSE NULL, |
| float531 | float | SPARSE NULL, |
| float532 | float | SPARSE NULL, |
| float533 | float | SPARSE NULL, |
| float534 | float | SPARSE NULL, |
| float535 | float | SPARSE NULL, |
| float536 | float | SPARSE NULL, |
| float537 | float | SPARSE NULL, |
| float538 | float | SPARSE NULL, |
| float539 | float | SPARSE NULL, |
| float540 | float | SPARSE NULL, |
| float541 | float | SPARSE NULL, |
| float542 | float | SPARSE NULL, |
| float543 | float | SPARSE NULL, |
| float544 | float | SPARSE NULL, |
| float545 | float | SPARSE NULL, |
| float546 | float | SPARSE NULL, |
| float547 | float | SPARSE NULL, |
| float548 | float | SPARSE NULL, |
| float549 | float | SPARSE NULL, |
| float550 | float | SPARSE NULL, |
| int1 | int | SPARSE NULL, |
| int2 | int | SPARSE NULL, |
| int3 | int | SPARSE NULL, |
| int4 | int | SPARSE NULL, |

| | | |
|-------|-----|--------------|
| int5 | int | SPARSE NULL, |
| int6 | int | SPARSE NULL, |
| int7 | int | SPARSE NULL, |
| int8 | int | SPARSE NULL, |
| int9 | int | SPARSE NULL, |
| int10 | int | SPARSE NULL, |
| int11 | int | SPARSE NULL, |
| int12 | int | SPARSE NULL, |
| int13 | int | SPARSE NULL, |
| int14 | int | SPARSE NULL, |
| int15 | int | SPARSE NULL, |
| int16 | int | SPARSE NULL, |
| int17 | int | SPARSE NULL, |
| int18 | int | SPARSE NULL, |
| int19 | int | SPARSE NULL, |
| int20 | int | SPARSE NULL, |
| int21 | int | SPARSE NULL, |
| int22 | int | SPARSE NULL, |
| int23 | int | SPARSE NULL, |
| int24 | int | SPARSE NULL, |
| int25 | int | SPARSE NULL, |
| int26 | int | SPARSE NULL, |
| int27 | int | SPARSE NULL, |
| int28 | int | SPARSE NULL, |
| int29 | int | SPARSE NULL, |
| int30 | int | SPARSE NULL, |
| int31 | int | SPARSE NULL, |
| int32 | int | SPARSE NULL, |
| int33 | int | SPARSE NULL, |
| int34 | int | SPARSE NULL, |
| int35 | int | SPARSE NULL, |
| int36 | int | SPARSE NULL, |
| int37 | int | SPARSE NULL, |
| int38 | int | SPARSE NULL, |
| int39 | int | SPARSE NULL, |
| int40 | int | SPARSE NULL, |
| int41 | int | SPARSE NULL, |
| int42 | int | SPARSE NULL, |
| int43 | int | SPARSE NULL, |
| int44 | int | SPARSE NULL, |
| int45 | int | SPARSE NULL, |
| int46 | int | SPARSE NULL, |
| int47 | int | SPARSE NULL, |
| int48 | int | SPARSE NULL, |
| int49 | int | SPARSE NULL, |
| int50 | int | SPARSE NULL, |
| int51 | int | SPARSE NULL, |
| int52 | int | SPARSE NULL, |
| int53 | int | SPARSE NULL, |
| int54 | int | SPARSE NULL, |
| int55 | int | SPARSE NULL, |
| int56 | int | SPARSE NULL, |
| int57 | int | SPARSE NULL, |
| int58 | int | SPARSE NULL, |
| int59 | int | SPARSE NULL, |
| int60 | int | SPARSE NULL, |
| int61 | int | SPARSE NULL, |
| int62 | int | SPARSE NULL, |
| int63 | int | SPARSE NULL, |

| | | |
|--------|-----|--------------|
| int64 | int | SPARSE NULL, |
| int65 | int | SPARSE NULL, |
| int66 | int | SPARSE NULL, |
| int67 | int | SPARSE NULL, |
| int68 | int | SPARSE NULL, |
| int69 | int | SPARSE NULL, |
| int70 | int | SPARSE NULL, |
| int71 | int | SPARSE NULL, |
| int72 | int | SPARSE NULL, |
| int73 | int | SPARSE NULL, |
| int74 | int | SPARSE NULL, |
| int75 | int | SPARSE NULL, |
| int76 | int | SPARSE NULL, |
| int77 | int | SPARSE NULL, |
| int78 | int | SPARSE NULL, |
| int79 | int | SPARSE NULL, |
| int80 | int | SPARSE NULL, |
| int81 | int | SPARSE NULL, |
| int82 | int | SPARSE NULL, |
| int83 | int | SPARSE NULL, |
| int84 | int | SPARSE NULL, |
| int85 | int | SPARSE NULL, |
| int86 | int | SPARSE NULL, |
| int87 | int | SPARSE NULL, |
| int88 | int | SPARSE NULL, |
| int89 | int | SPARSE NULL, |
| int90 | int | SPARSE NULL, |
| int91 | int | SPARSE NULL, |
| int92 | int | SPARSE NULL, |
| int93 | int | SPARSE NULL, |
| int94 | int | SPARSE NULL, |
| int95 | int | SPARSE NULL, |
| int96 | int | SPARSE NULL, |
| int97 | int | SPARSE NULL, |
| int98 | int | SPARSE NULL, |
| int99 | int | SPARSE NULL, |
| int100 | int | SPARSE NULL, |
| int101 | int | SPARSE NULL, |
| int102 | int | SPARSE NULL, |
| int103 | int | SPARSE NULL, |
| int104 | int | SPARSE NULL, |
| int105 | int | SPARSE NULL, |
| int106 | int | SPARSE NULL, |
| int107 | int | SPARSE NULL, |
| int108 | int | SPARSE NULL, |
| int109 | int | SPARSE NULL, |
| int110 | int | SPARSE NULL, |
| int111 | int | SPARSE NULL, |
| int112 | int | SPARSE NULL, |
| int113 | int | SPARSE NULL, |
| int114 | int | SPARSE NULL, |
| int115 | int | SPARSE NULL, |
| int116 | int | SPARSE NULL, |
| int117 | int | SPARSE NULL, |
| int118 | int | SPARSE NULL, |
| int119 | int | SPARSE NULL, |
| int120 | int | SPARSE NULL, |
| int121 | int | SPARSE NULL, |
| int122 | int | SPARSE NULL, |

| | | |
|--------|-----|--------------|
| int123 | int | SPARSE NULL, |
| int124 | int | SPARSE NULL, |
| int125 | int | SPARSE NULL, |
| int126 | int | SPARSE NULL, |
| int127 | int | SPARSE NULL, |
| int128 | int | SPARSE NULL, |
| int129 | int | SPARSE NULL, |
| int130 | int | SPARSE NULL, |
| int131 | int | SPARSE NULL, |
| int132 | int | SPARSE NULL, |
| int133 | int | SPARSE NULL, |
| int134 | int | SPARSE NULL, |
| int135 | int | SPARSE NULL, |
| int136 | int | SPARSE NULL, |
| int137 | int | SPARSE NULL, |
| int138 | int | SPARSE NULL, |
| int139 | int | SPARSE NULL, |
| int140 | int | SPARSE NULL, |
| int141 | int | SPARSE NULL, |
| int142 | int | SPARSE NULL, |
| int143 | int | SPARSE NULL, |
| int144 | int | SPARSE NULL, |
| int145 | int | SPARSE NULL, |
| int146 | int | SPARSE NULL, |
| int147 | int | SPARSE NULL, |
| int148 | int | SPARSE NULL, |
| int149 | int | SPARSE NULL, |
| int150 | int | SPARSE NULL, |
| int151 | int | SPARSE NULL, |
| int152 | int | SPARSE NULL, |
| int153 | int | SPARSE NULL, |
| int154 | int | SPARSE NULL, |
| int155 | int | SPARSE NULL, |
| int156 | int | SPARSE NULL, |
| int157 | int | SPARSE NULL, |
| int158 | int | SPARSE NULL, |
| int159 | int | SPARSE NULL, |
| int160 | int | SPARSE NULL, |
| int161 | int | SPARSE NULL, |
| int162 | int | SPARSE NULL, |
| int163 | int | SPARSE NULL, |
| int164 | int | SPARSE NULL, |
| int165 | int | SPARSE NULL, |
| int166 | int | SPARSE NULL, |
| int167 | int | SPARSE NULL, |
| int168 | int | SPARSE NULL, |
| int169 | int | SPARSE NULL, |
| int170 | int | SPARSE NULL, |
| int171 | int | SPARSE NULL, |
| int172 | int | SPARSE NULL, |
| int173 | int | SPARSE NULL, |
| int174 | int | SPARSE NULL, |
| int175 | int | SPARSE NULL, |
| int176 | int | SPARSE NULL, |
| int177 | int | SPARSE NULL, |
| int178 | int | SPARSE NULL, |
| int179 | int | SPARSE NULL, |
| int180 | int | SPARSE NULL, |
| int181 | int | SPARSE NULL, |

| | | |
|--------|-----|--------------|
| int182 | int | SPARSE NULL, |
| int183 | int | SPARSE NULL, |
| int184 | int | SPARSE NULL, |
| int185 | int | SPARSE NULL, |
| int186 | int | SPARSE NULL, |
| int187 | int | SPARSE NULL, |
| int188 | int | SPARSE NULL, |
| int189 | int | SPARSE NULL, |
| int190 | int | SPARSE NULL, |
| int191 | int | SPARSE NULL, |
| int192 | int | SPARSE NULL, |
| int193 | int | SPARSE NULL, |
| int194 | int | SPARSE NULL, |
| int195 | int | SPARSE NULL, |
| int196 | int | SPARSE NULL, |
| int197 | int | SPARSE NULL, |
| int198 | int | SPARSE NULL, |
| int199 | int | SPARSE NULL, |
| int200 | int | SPARSE NULL, |
| int201 | int | SPARSE NULL, |
| int202 | int | SPARSE NULL, |
| int203 | int | SPARSE NULL, |
| int204 | int | SPARSE NULL, |
| int205 | int | SPARSE NULL, |
| int206 | int | SPARSE NULL, |
| int207 | int | SPARSE NULL, |
| int208 | int | SPARSE NULL, |
| int209 | int | SPARSE NULL, |
| int210 | int | SPARSE NULL, |
| int211 | int | SPARSE NULL, |
| int212 | int | SPARSE NULL, |
| int213 | int | SPARSE NULL, |
| int214 | int | SPARSE NULL, |
| int215 | int | SPARSE NULL, |
| int216 | int | SPARSE NULL, |
| int217 | int | SPARSE NULL, |
| int218 | int | SPARSE NULL, |
| int219 | int | SPARSE NULL, |
| int220 | int | SPARSE NULL, |
| int221 | int | SPARSE NULL, |
| int222 | int | SPARSE NULL, |
| int223 | int | SPARSE NULL, |
| int224 | int | SPARSE NULL, |
| int225 | int | SPARSE NULL, |
| int226 | int | SPARSE NULL, |
| int227 | int | SPARSE NULL, |
| int228 | int | SPARSE NULL, |
| int229 | int | SPARSE NULL, |
| int230 | int | SPARSE NULL, |
| int231 | int | SPARSE NULL, |
| int232 | int | SPARSE NULL, |
| int233 | int | SPARSE NULL, |
| int234 | int | SPARSE NULL, |
| int235 | int | SPARSE NULL, |
| int236 | int | SPARSE NULL, |
| int237 | int | SPARSE NULL, |
| int238 | int | SPARSE NULL, |
| int239 | int | SPARSE NULL, |
| int240 | int | SPARSE NULL, |

| | | |
|--------|-----|--------------|
| int241 | int | SPARSE NULL, |
| int242 | int | SPARSE NULL, |
| int243 | int | SPARSE NULL, |
| int244 | int | SPARSE NULL, |
| int245 | int | SPARSE NULL, |
| int246 | int | SPARSE NULL, |
| int247 | int | SPARSE NULL, |
| int248 | int | SPARSE NULL, |
| int249 | int | SPARSE NULL, |
| int250 | int | SPARSE NULL, |
| int251 | int | SPARSE NULL, |
| int252 | int | SPARSE NULL, |
| int253 | int | SPARSE NULL, |
| int254 | int | SPARSE NULL, |
| int255 | int | SPARSE NULL, |
| int256 | int | SPARSE NULL, |
| int257 | int | SPARSE NULL, |
| int258 | int | SPARSE NULL, |
| int259 | int | SPARSE NULL, |
| int260 | int | SPARSE NULL, |
| int261 | int | SPARSE NULL, |
| int262 | int | SPARSE NULL, |
| int263 | int | SPARSE NULL, |
| int264 | int | SPARSE NULL, |
| int265 | int | SPARSE NULL, |
| int266 | int | SPARSE NULL, |
| int267 | int | SPARSE NULL, |
| int268 | int | SPARSE NULL, |
| int269 | int | SPARSE NULL, |
| int270 | int | SPARSE NULL, |
| int271 | int | SPARSE NULL, |
| int272 | int | SPARSE NULL, |
| int273 | int | SPARSE NULL, |
| int274 | int | SPARSE NULL, |
| int275 | int | SPARSE NULL, |
| int276 | int | SPARSE NULL, |
| int277 | int | SPARSE NULL, |
| int278 | int | SPARSE NULL, |
| int279 | int | SPARSE NULL, |
| int280 | int | SPARSE NULL, |
| int281 | int | SPARSE NULL, |
| int282 | int | SPARSE NULL, |
| int283 | int | SPARSE NULL, |
| int284 | int | SPARSE NULL, |
| int285 | int | SPARSE NULL, |
| int286 | int | SPARSE NULL, |
| int287 | int | SPARSE NULL, |
| int288 | int | SPARSE NULL, |
| int289 | int | SPARSE NULL, |
| int290 | int | SPARSE NULL, |
| int291 | int | SPARSE NULL, |
| int292 | int | SPARSE NULL, |
| int293 | int | SPARSE NULL, |
| int294 | int | SPARSE NULL, |
| int295 | int | SPARSE NULL, |
| int296 | int | SPARSE NULL, |
| int297 | int | SPARSE NULL, |
| int298 | int | SPARSE NULL, |
| int299 | int | SPARSE NULL, |

| | | |
|--------|-----|--------------|
| int300 | int | SPARSE NULL, |
| int301 | int | SPARSE NULL, |
| int302 | int | SPARSE NULL, |
| int303 | int | SPARSE NULL, |
| int304 | int | SPARSE NULL, |
| int305 | int | SPARSE NULL, |
| int306 | int | SPARSE NULL, |
| int307 | int | SPARSE NULL, |
| int308 | int | SPARSE NULL, |
| int309 | int | SPARSE NULL, |
| int310 | int | SPARSE NULL, |
| int311 | int | SPARSE NULL, |
| int312 | int | SPARSE NULL, |
| int313 | int | SPARSE NULL, |
| int314 | int | SPARSE NULL, |
| int315 | int | SPARSE NULL, |
| int316 | int | SPARSE NULL, |
| int317 | int | SPARSE NULL, |
| int318 | int | SPARSE NULL, |
| int319 | int | SPARSE NULL, |
| int320 | int | SPARSE NULL, |
| int321 | int | SPARSE NULL, |
| int322 | int | SPARSE NULL, |
| int323 | int | SPARSE NULL, |
| int324 | int | SPARSE NULL, |
| int325 | int | SPARSE NULL, |
| int326 | int | SPARSE NULL, |
| int327 | int | SPARSE NULL, |
| int328 | int | SPARSE NULL, |
| int329 | int | SPARSE NULL, |
| int330 | int | SPARSE NULL, |
| int331 | int | SPARSE NULL, |
| int332 | int | SPARSE NULL, |
| int333 | int | SPARSE NULL, |
| int334 | int | SPARSE NULL, |
| int335 | int | SPARSE NULL, |
| int336 | int | SPARSE NULL, |
| int337 | int | SPARSE NULL, |
| int338 | int | SPARSE NULL, |
| int339 | int | SPARSE NULL, |
| int340 | int | SPARSE NULL, |
| int341 | int | SPARSE NULL, |
| int342 | int | SPARSE NULL, |
| int343 | int | SPARSE NULL, |
| int344 | int | SPARSE NULL, |
| int345 | int | SPARSE NULL, |
| int346 | int | SPARSE NULL, |
| int347 | int | SPARSE NULL, |
| int348 | int | SPARSE NULL, |
| int349 | int | SPARSE NULL, |
| int350 | int | SPARSE NULL, |
| int351 | int | SPARSE NULL, |
| int352 | int | SPARSE NULL, |
| int353 | int | SPARSE NULL, |
| int354 | int | SPARSE NULL, |
| int355 | int | SPARSE NULL, |
| int356 | int | SPARSE NULL, |
| int357 | int | SPARSE NULL, |
| int358 | int | SPARSE NULL, |

| | | |
|--------|-----|--------------|
| int359 | int | SPARSE NULL, |
| int360 | int | SPARSE NULL, |
| int361 | int | SPARSE NULL, |
| int362 | int | SPARSE NULL, |
| int363 | int | SPARSE NULL, |
| int364 | int | SPARSE NULL, |
| int365 | int | SPARSE NULL, |
| int366 | int | SPARSE NULL, |
| int367 | int | SPARSE NULL, |
| int368 | int | SPARSE NULL, |
| int369 | int | SPARSE NULL, |
| int370 | int | SPARSE NULL, |
| int371 | int | SPARSE NULL, |
| int372 | int | SPARSE NULL, |
| int373 | int | SPARSE NULL, |
| int374 | int | SPARSE NULL, |
| int375 | int | SPARSE NULL, |
| int376 | int | SPARSE NULL, |
| int377 | int | SPARSE NULL, |
| int378 | int | SPARSE NULL, |
| int379 | int | SPARSE NULL, |
| int380 | int | SPARSE NULL, |
| int381 | int | SPARSE NULL, |
| int382 | int | SPARSE NULL, |
| int383 | int | SPARSE NULL, |
| int384 | int | SPARSE NULL, |
| int385 | int | SPARSE NULL, |
| int386 | int | SPARSE NULL, |
| int387 | int | SPARSE NULL, |
| int388 | int | SPARSE NULL, |
| int389 | int | SPARSE NULL, |
| int390 | int | SPARSE NULL, |
| int391 | int | SPARSE NULL, |
| int392 | int | SPARSE NULL, |
| int393 | int | SPARSE NULL, |
| int394 | int | SPARSE NULL, |
| int395 | int | SPARSE NULL, |
| int396 | int | SPARSE NULL, |
| int397 | int | SPARSE NULL, |
| int398 | int | SPARSE NULL, |
| int399 | int | SPARSE NULL, |
| int400 | int | SPARSE NULL, |
| int401 | int | SPARSE NULL, |
| int402 | int | SPARSE NULL, |
| int403 | int | SPARSE NULL, |
| int404 | int | SPARSE NULL, |
| int405 | int | SPARSE NULL, |
| int406 | int | SPARSE NULL, |
| int407 | int | SPARSE NULL, |
| int408 | int | SPARSE NULL, |
| int409 | int | SPARSE NULL, |
| int410 | int | SPARSE NULL, |
| int411 | int | SPARSE NULL, |
| int412 | int | SPARSE NULL, |
| int413 | int | SPARSE NULL, |
| int414 | int | SPARSE NULL, |
| int415 | int | SPARSE NULL, |
| int416 | int | SPARSE NULL, |
| int417 | int | SPARSE NULL, |

| | | |
|--------|-----|--------------|
| int418 | int | SPARSE NULL, |
| int419 | int | SPARSE NULL, |
| int420 | int | SPARSE NULL, |
| int421 | int | SPARSE NULL, |
| int422 | int | SPARSE NULL, |
| int423 | int | SPARSE NULL, |
| int424 | int | SPARSE NULL, |
| int425 | int | SPARSE NULL, |
| int426 | int | SPARSE NULL, |
| int427 | int | SPARSE NULL, |
| int428 | int | SPARSE NULL, |
| int429 | int | SPARSE NULL, |
| int430 | int | SPARSE NULL, |
| int431 | int | SPARSE NULL, |
| int432 | int | SPARSE NULL, |
| int433 | int | SPARSE NULL, |
| int434 | int | SPARSE NULL, |
| int435 | int | SPARSE NULL, |
| int436 | int | SPARSE NULL, |
| int437 | int | SPARSE NULL, |
| int438 | int | SPARSE NULL, |
| int439 | int | SPARSE NULL, |
| int440 | int | SPARSE NULL, |
| int441 | int | SPARSE NULL, |
| int442 | int | SPARSE NULL, |
| int443 | int | SPARSE NULL, |
| int444 | int | SPARSE NULL, |
| int445 | int | SPARSE NULL, |
| int446 | int | SPARSE NULL, |
| int447 | int | SPARSE NULL, |
| int448 | int | SPARSE NULL, |
| int449 | int | SPARSE NULL, |
| int450 | int | SPARSE NULL, |
| int451 | int | SPARSE NULL, |
| int452 | int | SPARSE NULL, |
| int453 | int | SPARSE NULL, |
| int454 | int | SPARSE NULL, |
| int455 | int | SPARSE NULL, |
| int456 | int | SPARSE NULL, |
| int457 | int | SPARSE NULL, |
| int458 | int | SPARSE NULL, |
| int459 | int | SPARSE NULL, |
| int460 | int | SPARSE NULL, |
| int461 | int | SPARSE NULL, |
| int462 | int | SPARSE NULL, |
| int463 | int | SPARSE NULL, |
| int464 | int | SPARSE NULL, |
| int465 | int | SPARSE NULL, |
| int466 | int | SPARSE NULL, |
| int467 | int | SPARSE NULL, |
| int468 | int | SPARSE NULL, |
| int469 | int | SPARSE NULL, |
| int470 | int | SPARSE NULL, |
| int471 | int | SPARSE NULL, |
| int472 | int | SPARSE NULL, |
| int473 | int | SPARSE NULL, |
| int474 | int | SPARSE NULL, |
| int475 | int | SPARSE NULL, |
| int476 | int | SPARSE NULL, |

| | | |
|--------|-----|--------------|
| int477 | int | SPARSE NULL, |
| int478 | int | SPARSE NULL, |
| int479 | int | SPARSE NULL, |
| int480 | int | SPARSE NULL, |
| int481 | int | SPARSE NULL, |
| int482 | int | SPARSE NULL, |
| int483 | int | SPARSE NULL, |
| int484 | int | SPARSE NULL, |
| int485 | int | SPARSE NULL, |
| int486 | int | SPARSE NULL, |
| int487 | int | SPARSE NULL, |
| int488 | int | SPARSE NULL, |
| int489 | int | SPARSE NULL, |
| int490 | int | SPARSE NULL, |
| int491 | int | SPARSE NULL, |
| int492 | int | SPARSE NULL, |
| int493 | int | SPARSE NULL, |
| int494 | int | SPARSE NULL, |
| int495 | int | SPARSE NULL, |
| int496 | int | SPARSE NULL, |
| int497 | int | SPARSE NULL, |
| int498 | int | SPARSE NULL, |
| int499 | int | SPARSE NULL, |
| int500 | int | SPARSE NULL, |
| int501 | int | SPARSE NULL, |
| int502 | int | SPARSE NULL, |
| int503 | int | SPARSE NULL, |
| int504 | int | SPARSE NULL, |
| int505 | int | SPARSE NULL, |
| int506 | int | SPARSE NULL, |
| int507 | int | SPARSE NULL, |
| int508 | int | SPARSE NULL, |
| int509 | int | SPARSE NULL, |
| int510 | int | SPARSE NULL, |
| int511 | int | SPARSE NULL, |
| int512 | int | SPARSE NULL, |
| int513 | int | SPARSE NULL, |
| int514 | int | SPARSE NULL, |
| int515 | int | SPARSE NULL, |
| int516 | int | SPARSE NULL, |
| int517 | int | SPARSE NULL, |
| int518 | int | SPARSE NULL, |
| int519 | int | SPARSE NULL, |
| int520 | int | SPARSE NULL, |
| int521 | int | SPARSE NULL, |
| int522 | int | SPARSE NULL, |
| int523 | int | SPARSE NULL, |
| int524 | int | SPARSE NULL, |
| int525 | int | SPARSE NULL, |
| int526 | int | SPARSE NULL, |
| int527 | int | SPARSE NULL, |
| int528 | int | SPARSE NULL, |
| int529 | int | SPARSE NULL, |
| int530 | int | SPARSE NULL, |
| int531 | int | SPARSE NULL, |
| int532 | int | SPARSE NULL, |
| int533 | int | SPARSE NULL, |
| int534 | int | SPARSE NULL, |
| int535 | int | SPARSE NULL, |

| | | |
|--------|-----|--------------|
| int536 | int | SPARSE NULL, |
| int537 | int | SPARSE NULL, |
| int538 | int | SPARSE NULL, |
| int539 | int | SPARSE NULL, |
| int540 | int | SPARSE NULL, |
| int541 | int | SPARSE NULL, |
| int542 | int | SPARSE NULL, |
| int543 | int | SPARSE NULL, |
| int544 | int | SPARSE NULL, |
| int545 | int | SPARSE NULL, |
| int546 | int | SPARSE NULL, |
| int547 | int | SPARSE NULL, |
| int548 | int | SPARSE NULL, |
| int549 | int | SPARSE NULL, |
| int550 | int | SPARSE NULL, |
| int551 | int | SPARSE NULL, |
| int552 | int | SPARSE NULL, |
| int553 | int | SPARSE NULL, |
| int554 | int | SPARSE NULL, |
| int555 | int | SPARSE NULL, |
| int556 | int | SPARSE NULL, |
| int557 | int | SPARSE NULL, |
| int558 | int | SPARSE NULL, |
| int559 | int | SPARSE NULL, |
| int560 | int | SPARSE NULL, |
| int561 | int | SPARSE NULL, |
| int562 | int | SPARSE NULL, |
| int563 | int | SPARSE NULL, |
| int564 | int | SPARSE NULL, |
| int565 | int | SPARSE NULL, |
| int566 | int | SPARSE NULL, |
| int567 | int | SPARSE NULL, |
| int568 | int | SPARSE NULL, |
| int569 | int | SPARSE NULL, |
| int570 | int | SPARSE NULL, |
| int571 | int | SPARSE NULL, |
| int572 | int | SPARSE NULL, |
| int573 | int | SPARSE NULL, |
| int574 | int | SPARSE NULL, |
| int575 | int | SPARSE NULL, |
| int576 | int | SPARSE NULL, |
| int577 | int | SPARSE NULL, |
| int578 | int | SPARSE NULL, |
| int579 | int | SPARSE NULL, |
| int580 | int | SPARSE NULL, |
| int581 | int | SPARSE NULL, |
| int582 | int | SPARSE NULL, |
| int583 | int | SPARSE NULL, |
| int584 | int | SPARSE NULL, |
| int585 | int | SPARSE NULL, |
| int586 | int | SPARSE NULL, |
| int587 | int | SPARSE NULL, |
| int588 | int | SPARSE NULL, |
| int589 | int | SPARSE NULL, |
| int590 | int | SPARSE NULL, |
| int591 | int | SPARSE NULL, |
| int592 | int | SPARSE NULL, |
| int593 | int | SPARSE NULL, |
| int594 | int | SPARSE NULL, |

| | | |
|--------|-----|--------------|
| int595 | int | SPARSE NULL, |
| int596 | int | SPARSE NULL, |
| int597 | int | SPARSE NULL, |
| int598 | int | SPARSE NULL, |
| int599 | int | SPARSE NULL, |
| int600 | int | SPARSE NULL, |
| int601 | int | SPARSE NULL, |
| int602 | int | SPARSE NULL, |
| int603 | int | SPARSE NULL, |
| int604 | int | SPARSE NULL, |
| int605 | int | SPARSE NULL, |
| int606 | int | SPARSE NULL, |
| int607 | int | SPARSE NULL, |
| int608 | int | SPARSE NULL, |
| int609 | int | SPARSE NULL, |
| int610 | int | SPARSE NULL, |
| int611 | int | SPARSE NULL, |
| int612 | int | SPARSE NULL, |
| int613 | int | SPARSE NULL, |
| int614 | int | SPARSE NULL, |
| int615 | int | SPARSE NULL, |
| int616 | int | SPARSE NULL, |
| int617 | int | SPARSE NULL, |
| int618 | int | SPARSE NULL, |
| int619 | int | SPARSE NULL, |
| int620 | int | SPARSE NULL, |
| int621 | int | SPARSE NULL, |
| int622 | int | SPARSE NULL, |
| int623 | int | SPARSE NULL, |
| int624 | int | SPARSE NULL, |
| int625 | int | SPARSE NULL, |
| int626 | int | SPARSE NULL, |
| int627 | int | SPARSE NULL, |
| int628 | int | SPARSE NULL, |
| int629 | int | SPARSE NULL, |
| int630 | int | SPARSE NULL, |
| int631 | int | SPARSE NULL, |
| int632 | int | SPARSE NULL, |
| int633 | int | SPARSE NULL, |
| int634 | int | SPARSE NULL, |
| int635 | int | SPARSE NULL, |
| int636 | int | SPARSE NULL, |
| int637 | int | SPARSE NULL, |
| int638 | int | SPARSE NULL, |
| int639 | int | SPARSE NULL, |
| int640 | int | SPARSE NULL, |
| int641 | int | SPARSE NULL, |
| int642 | int | SPARSE NULL, |
| int643 | int | SPARSE NULL, |
| int644 | int | SPARSE NULL, |
| int645 | int | SPARSE NULL, |
| int646 | int | SPARSE NULL, |
| int647 | int | SPARSE NULL, |
| int648 | int | SPARSE NULL, |
| int649 | int | SPARSE NULL, |
| int650 | int | SPARSE NULL, |
| int651 | int | SPARSE NULL, |
| int652 | int | SPARSE NULL, |
| int653 | int | SPARSE NULL, |

| | | |
|--------|-----|--------------|
| int654 | int | SPARSE NULL, |
| int655 | int | SPARSE NULL, |
| int656 | int | SPARSE NULL, |
| int657 | int | SPARSE NULL, |
| int658 | int | SPARSE NULL, |
| int659 | int | SPARSE NULL, |
| int660 | int | SPARSE NULL, |
| int661 | int | SPARSE NULL, |
| int662 | int | SPARSE NULL, |
| int663 | int | SPARSE NULL, |
| int664 | int | SPARSE NULL, |
| int665 | int | SPARSE NULL, |
| int666 | int | SPARSE NULL, |
| int667 | int | SPARSE NULL, |
| int668 | int | SPARSE NULL, |
| int669 | int | SPARSE NULL, |
| int670 | int | SPARSE NULL, |
| int671 | int | SPARSE NULL, |
| int672 | int | SPARSE NULL, |
| int673 | int | SPARSE NULL, |
| int674 | int | SPARSE NULL, |
| int675 | int | SPARSE NULL, |
| int676 | int | SPARSE NULL, |
| int677 | int | SPARSE NULL, |
| int678 | int | SPARSE NULL, |
| int679 | int | SPARSE NULL, |
| int680 | int | SPARSE NULL, |
| int681 | int | SPARSE NULL, |
| int682 | int | SPARSE NULL, |
| int683 | int | SPARSE NULL, |
| int684 | int | SPARSE NULL, |
| int685 | int | SPARSE NULL, |
| int686 | int | SPARSE NULL, |
| int687 | int | SPARSE NULL, |
| int688 | int | SPARSE NULL, |
| int689 | int | SPARSE NULL, |
| int690 | int | SPARSE NULL, |
| int691 | int | SPARSE NULL, |
| int692 | int | SPARSE NULL, |
| int693 | int | SPARSE NULL, |
| int694 | int | SPARSE NULL, |
| int695 | int | SPARSE NULL, |
| int696 | int | SPARSE NULL, |
| int697 | int | SPARSE NULL, |
| int698 | int | SPARSE NULL, |
| int699 | int | SPARSE NULL, |
| int700 | int | SPARSE NULL, |
| int701 | int | SPARSE NULL, |
| int702 | int | SPARSE NULL, |
| int703 | int | SPARSE NULL, |
| int704 | int | SPARSE NULL, |
| int705 | int | SPARSE NULL, |
| int706 | int | SPARSE NULL, |
| int707 | int | SPARSE NULL, |
| int708 | int | SPARSE NULL, |
| int709 | int | SPARSE NULL, |
| int710 | int | SPARSE NULL, |
| int711 | int | SPARSE NULL, |
| int712 | int | SPARSE NULL, |

| | | |
|---------|----------------|--------------|
| int713 | int | SPARSE NULL, |
| int714 | int | SPARSE NULL, |
| int715 | int | SPARSE NULL, |
| int716 | int | SPARSE NULL, |
| int717 | int | SPARSE NULL, |
| int718 | int | SPARSE NULL, |
| int719 | int | SPARSE NULL, |
| int720 | int | SPARSE NULL, |
| int721 | int | SPARSE NULL, |
| int722 | int | SPARSE NULL, |
| int723 | int | SPARSE NULL, |
| int724 | int | SPARSE NULL, |
| int725 | int | SPARSE NULL, |
| int726 | int | SPARSE NULL, |
| int727 | int | SPARSE NULL, |
| int728 | int | SPARSE NULL, |
| int729 | int | SPARSE NULL, |
| int730 | int | SPARSE NULL, |
| int731 | int | SPARSE NULL, |
| int732 | int | SPARSE NULL, |
| int733 | int | SPARSE NULL, |
| int734 | int | SPARSE NULL, |
| int735 | int | SPARSE NULL, |
| int736 | int | SPARSE NULL, |
| int737 | int | SPARSE NULL, |
| int738 | int | SPARSE NULL, |
| int739 | int | SPARSE NULL, |
| int740 | int | SPARSE NULL, |
| int741 | int | SPARSE NULL, |
| int742 | int | SPARSE NULL, |
| int743 | int | SPARSE NULL, |
| int744 | int | SPARSE NULL, |
| int745 | int | SPARSE NULL, |
| int746 | int | SPARSE NULL, |
| int747 | int | SPARSE NULL, |
| int748 | int | SPARSE NULL, |
| int749 | int | SPARSE NULL, |
| int750 | int | SPARSE NULL, |
| ntext1 | nvarchar (max) | SPARSE NULL, |
| ntext2 | nvarchar (max) | SPARSE NULL, |
| ntext3 | nvarchar (max) | SPARSE NULL, |
| ntext4 | nvarchar (max) | SPARSE NULL, |
| ntext5 | nvarchar (max) | SPARSE NULL, |
| ntext6 | nvarchar (max) | SPARSE NULL, |
| ntext7 | nvarchar (max) | SPARSE NULL, |
| ntext8 | nvarchar (max) | SPARSE NULL, |
| ntext9 | nvarchar (max) | SPARSE NULL, |
| ntext10 | nvarchar (max) | SPARSE NULL, |
| ntext11 | nvarchar (max) | SPARSE NULL, |
| ntext12 | nvarchar (max) | SPARSE NULL, |
| ntext13 | nvarchar (max) | SPARSE NULL, |
| ntext14 | nvarchar (max) | SPARSE NULL, |
| ntext15 | nvarchar (max) | SPARSE NULL, |
| ntext16 | nvarchar (max) | SPARSE NULL, |
| ntext17 | nvarchar (max) | SPARSE NULL, |
| ntext18 | nvarchar (max) | SPARSE NULL, |
| ntext19 | nvarchar (max) | SPARSE NULL, |
| ntext20 | nvarchar (max) | SPARSE NULL, |
| ntext21 | nvarchar (max) | SPARSE NULL, |

| | | | |
|---------|---------------|--------|-------|
| ntext22 | nvarchar(max) | SPARSE | NULL, |
| ntext23 | nvarchar(max) | SPARSE | NULL, |
| ntext24 | nvarchar(max) | SPARSE | NULL, |
| ntext25 | nvarchar(max) | SPARSE | NULL, |
| ntext26 | nvarchar(max) | SPARSE | NULL, |
| ntext27 | nvarchar(max) | SPARSE | NULL, |
| ntext28 | nvarchar(max) | SPARSE | NULL, |
| ntext29 | nvarchar(max) | SPARSE | NULL, |
| ntext30 | nvarchar(max) | SPARSE | NULL, |
| ntext31 | nvarchar(max) | SPARSE | NULL, |
| ntext32 | nvarchar(max) | SPARSE | NULL, |
| ntext33 | nvarchar(max) | SPARSE | NULL, |
| ntext34 | nvarchar(max) | SPARSE | NULL, |
| ntext35 | nvarchar(max) | SPARSE | NULL, |
| ntext36 | nvarchar(max) | SPARSE | NULL, |
| ntext37 | nvarchar(max) | SPARSE | NULL, |
| ntext38 | nvarchar(max) | SPARSE | NULL, |
| ntext39 | nvarchar(max) | SPARSE | NULL, |
| ntext40 | nvarchar(max) | SPARSE | NULL, |
| ntext41 | nvarchar(max) | SPARSE | NULL, |
| ntext42 | nvarchar(max) | SPARSE | NULL, |
| ntext43 | nvarchar(max) | SPARSE | NULL, |
| ntext44 | nvarchar(max) | SPARSE | NULL, |
| ntext45 | nvarchar(max) | SPARSE | NULL, |
| ntext46 | nvarchar(max) | SPARSE | NULL, |
| ntext47 | nvarchar(max) | SPARSE | NULL, |
| ntext48 | nvarchar(max) | SPARSE | NULL, |
| ntext49 | nvarchar(max) | SPARSE | NULL, |
| ntext50 | nvarchar(max) | SPARSE | NULL, |
| ntext51 | nvarchar(max) | SPARSE | NULL, |
| ntext52 | nvarchar(max) | SPARSE | NULL, |
| ntext53 | nvarchar(max) | SPARSE | NULL, |
| ntext54 | nvarchar(max) | SPARSE | NULL, |
| ntext55 | nvarchar(max) | SPARSE | NULL, |
| ntext56 | nvarchar(max) | SPARSE | NULL, |
| ntext57 | nvarchar(max) | SPARSE | NULL, |
| ntext58 | nvarchar(max) | SPARSE | NULL, |
| ntext59 | nvarchar(max) | SPARSE | NULL, |
| ntext60 | nvarchar(max) | SPARSE | NULL, |
| ntext61 | nvarchar(max) | SPARSE | NULL, |
| ntext62 | nvarchar(max) | SPARSE | NULL, |
| ntext63 | nvarchar(max) | SPARSE | NULL, |
| ntext64 | nvarchar(max) | SPARSE | NULL, |
| ntext65 | nvarchar(max) | SPARSE | NULL, |
| ntext66 | nvarchar(max) | SPARSE | NULL, |
| ntext67 | nvarchar(max) | SPARSE | NULL, |
| ntext68 | nvarchar(max) | SPARSE | NULL, |
| ntext69 | nvarchar(max) | SPARSE | NULL, |
| ntext70 | nvarchar(max) | SPARSE | NULL, |
| ntext71 | nvarchar(max) | SPARSE | NULL, |
| ntext72 | nvarchar(max) | SPARSE | NULL, |
| ntext73 | nvarchar(max) | SPARSE | NULL, |
| ntext74 | nvarchar(max) | SPARSE | NULL, |
| ntext75 | nvarchar(max) | SPARSE | NULL, |
| ntext76 | nvarchar(max) | SPARSE | NULL, |
| ntext77 | nvarchar(max) | SPARSE | NULL, |
| ntext78 | nvarchar(max) | SPARSE | NULL, |
| ntext79 | nvarchar(max) | SPARSE | NULL, |
| ntext80 | nvarchar(max) | SPARSE | NULL, |

| | | | |
|----------|----------------|--------|-------|
| ntext81 | nvarchar (max) | SPARSE | NULL, |
| ntext82 | nvarchar (max) | SPARSE | NULL, |
| ntext83 | nvarchar (max) | SPARSE | NULL, |
| ntext84 | nvarchar (max) | SPARSE | NULL, |
| ntext85 | nvarchar (max) | SPARSE | NULL, |
| ntext86 | nvarchar (max) | SPARSE | NULL, |
| ntext87 | nvarchar (max) | SPARSE | NULL, |
| ntext88 | nvarchar (max) | SPARSE | NULL, |
| ntext89 | nvarchar (max) | SPARSE | NULL, |
| ntext90 | nvarchar (max) | SPARSE | NULL, |
| ntext91 | nvarchar (max) | SPARSE | NULL, |
| ntext92 | nvarchar (max) | SPARSE | NULL, |
| ntext93 | nvarchar (max) | SPARSE | NULL, |
| ntext94 | nvarchar (max) | SPARSE | NULL, |
| ntext95 | nvarchar (max) | SPARSE | NULL, |
| ntext96 | nvarchar (max) | SPARSE | NULL, |
| ntext97 | nvarchar (max) | SPARSE | NULL, |
| ntext98 | nvarchar (max) | SPARSE | NULL, |
| ntext99 | nvarchar (max) | SPARSE | NULL, |
| ntext100 | nvarchar (max) | SPARSE | NULL, |
| ntext101 | nvarchar (max) | SPARSE | NULL, |
| ntext102 | nvarchar (max) | SPARSE | NULL, |
| ntext103 | nvarchar (max) | SPARSE | NULL, |
| ntext104 | nvarchar (max) | SPARSE | NULL, |
| ntext105 | nvarchar (max) | SPARSE | NULL, |
| ntext106 | nvarchar (max) | SPARSE | NULL, |
| ntext107 | nvarchar (max) | SPARSE | NULL, |
| ntext108 | nvarchar (max) | SPARSE | NULL, |
| ntext109 | nvarchar (max) | SPARSE | NULL, |
| ntext110 | nvarchar (max) | SPARSE | NULL, |
| ntext111 | nvarchar (max) | SPARSE | NULL, |
| ntext112 | nvarchar (max) | SPARSE | NULL, |
| ntext113 | nvarchar (max) | SPARSE | NULL, |
| ntext114 | nvarchar (max) | SPARSE | NULL, |
| ntext115 | nvarchar (max) | SPARSE | NULL, |
| ntext116 | nvarchar (max) | SPARSE | NULL, |
| ntext117 | nvarchar (max) | SPARSE | NULL, |
| ntext118 | nvarchar (max) | SPARSE | NULL, |
| ntext119 | nvarchar (max) | SPARSE | NULL, |
| ntext120 | nvarchar (max) | SPARSE | NULL, |
| ntext121 | nvarchar (max) | SPARSE | NULL, |
| ntext122 | nvarchar (max) | SPARSE | NULL, |
| ntext123 | nvarchar (max) | SPARSE | NULL, |
| ntext124 | nvarchar (max) | SPARSE | NULL, |
| ntext125 | nvarchar (max) | SPARSE | NULL, |
| ntext126 | nvarchar (max) | SPARSE | NULL, |
| ntext127 | nvarchar (max) | SPARSE | NULL, |
| ntext128 | nvarchar (max) | SPARSE | NULL, |
| ntext129 | nvarchar (max) | SPARSE | NULL, |
| ntext130 | nvarchar (max) | SPARSE | NULL, |
| ntext131 | nvarchar (max) | SPARSE | NULL, |
| ntext132 | nvarchar (max) | SPARSE | NULL, |
| ntext133 | nvarchar (max) | SPARSE | NULL, |
| ntext134 | nvarchar (max) | SPARSE | NULL, |
| ntext135 | nvarchar (max) | SPARSE | NULL, |
| ntext136 | nvarchar (max) | SPARSE | NULL, |
| ntext137 | nvarchar (max) | SPARSE | NULL, |
| ntext138 | nvarchar (max) | SPARSE | NULL, |
| ntext139 | nvarchar (max) | SPARSE | NULL, |

| | | |
|----------|----------------|--------------|
| ntext140 | nvarchar (max) | SPARSE NULL, |
| ntext141 | nvarchar (max) | SPARSE NULL, |
| ntext142 | nvarchar (max) | SPARSE NULL, |
| ntext143 | nvarchar (max) | SPARSE NULL, |
| ntext144 | nvarchar (max) | SPARSE NULL, |
| ntext145 | nvarchar (max) | SPARSE NULL, |
| ntext146 | nvarchar (max) | SPARSE NULL, |
| ntext147 | nvarchar (max) | SPARSE NULL, |
| ntext148 | nvarchar (max) | SPARSE NULL, |
| ntext149 | nvarchar (max) | SPARSE NULL, |
| ntext150 | nvarchar (max) | SPARSE NULL, |
| ntext151 | nvarchar (max) | SPARSE NULL, |
| ntext152 | nvarchar (max) | SPARSE NULL, |
| ntext153 | nvarchar (max) | SPARSE NULL, |
| ntext154 | nvarchar (max) | SPARSE NULL, |
| ntext155 | nvarchar (max) | SPARSE NULL, |
| ntext156 | nvarchar (max) | SPARSE NULL, |
| ntext157 | nvarchar (max) | SPARSE NULL, |
| ntext158 | nvarchar (max) | SPARSE NULL, |
| ntext159 | nvarchar (max) | SPARSE NULL, |
| ntext160 | nvarchar (max) | SPARSE NULL, |
| ntext161 | nvarchar (max) | SPARSE NULL, |
| ntext162 | nvarchar (max) | SPARSE NULL, |
| ntext163 | nvarchar (max) | SPARSE NULL, |
| ntext164 | nvarchar (max) | SPARSE NULL, |
| ntext165 | nvarchar (max) | SPARSE NULL, |
| ntext166 | nvarchar (max) | SPARSE NULL, |
| ntext167 | nvarchar (max) | SPARSE NULL, |
| ntext168 | nvarchar (max) | SPARSE NULL, |
| ntext169 | nvarchar (max) | SPARSE NULL, |
| ntext170 | nvarchar (max) | SPARSE NULL, |
| ntext171 | nvarchar (max) | SPARSE NULL, |
| ntext172 | nvarchar (max) | SPARSE NULL, |
| ntext173 | nvarchar (max) | SPARSE NULL, |
| ntext174 | nvarchar (max) | SPARSE NULL, |
| ntext175 | nvarchar (max) | SPARSE NULL, |
| ntext176 | nvarchar (max) | SPARSE NULL, |
| ntext177 | nvarchar (max) | SPARSE NULL, |
| ntext178 | nvarchar (max) | SPARSE NULL, |
| ntext179 | nvarchar (max) | SPARSE NULL, |
| ntext180 | nvarchar (max) | SPARSE NULL, |
| ntext181 | nvarchar (max) | SPARSE NULL, |
| ntext182 | nvarchar (max) | SPARSE NULL, |
| ntext183 | nvarchar (max) | SPARSE NULL, |
| ntext184 | nvarchar (max) | SPARSE NULL, |
| ntext185 | nvarchar (max) | SPARSE NULL, |
| ntext186 | nvarchar (max) | SPARSE NULL, |
| ntext187 | nvarchar (max) | SPARSE NULL, |
| ntext188 | nvarchar (max) | SPARSE NULL, |
| ntext189 | nvarchar (max) | SPARSE NULL, |
| ntext190 | nvarchar (max) | SPARSE NULL, |
| ntext191 | nvarchar (max) | SPARSE NULL, |
| ntext192 | nvarchar (max) | SPARSE NULL, |
| ntext193 | nvarchar (max) | SPARSE NULL, |
| ntext194 | nvarchar (max) | SPARSE NULL, |
| ntext195 | nvarchar (max) | SPARSE NULL, |
| ntext196 | nvarchar (max) | SPARSE NULL, |
| ntext197 | nvarchar (max) | SPARSE NULL, |
| ntext198 | nvarchar (max) | SPARSE NULL, |

| | | |
|----------|----------------|--------------|
| ntext199 | nvarchar (max) | SPARSE NULL, |
| ntext200 | nvarchar (max) | SPARSE NULL, |
| ntext201 | nvarchar (max) | SPARSE NULL, |
| ntext202 | nvarchar (max) | SPARSE NULL, |
| ntext203 | nvarchar (max) | SPARSE NULL, |
| ntext204 | nvarchar (max) | SPARSE NULL, |
| ntext205 | nvarchar (max) | SPARSE NULL, |
| ntext206 | nvarchar (max) | SPARSE NULL, |
| ntext207 | nvarchar (max) | SPARSE NULL, |
| ntext208 | nvarchar (max) | SPARSE NULL, |
| ntext209 | nvarchar (max) | SPARSE NULL, |
| ntext210 | nvarchar (max) | SPARSE NULL, |
| ntext211 | nvarchar (max) | SPARSE NULL, |
| ntext212 | nvarchar (max) | SPARSE NULL, |
| ntext213 | nvarchar (max) | SPARSE NULL, |
| ntext214 | nvarchar (max) | SPARSE NULL, |
| ntext215 | nvarchar (max) | SPARSE NULL, |
| ntext216 | nvarchar (max) | SPARSE NULL, |
| ntext217 | nvarchar (max) | SPARSE NULL, |
| ntext218 | nvarchar (max) | SPARSE NULL, |
| ntext219 | nvarchar (max) | SPARSE NULL, |
| ntext220 | nvarchar (max) | SPARSE NULL, |
| ntext221 | nvarchar (max) | SPARSE NULL, |
| ntext222 | nvarchar (max) | SPARSE NULL, |
| ntext223 | nvarchar (max) | SPARSE NULL, |
| ntext224 | nvarchar (max) | SPARSE NULL, |
| ntext225 | nvarchar (max) | SPARSE NULL, |
| ntext226 | nvarchar (max) | SPARSE NULL, |
| ntext227 | nvarchar (max) | SPARSE NULL, |
| ntext228 | nvarchar (max) | SPARSE NULL, |
| ntext229 | nvarchar (max) | SPARSE NULL, |
| ntext230 | nvarchar (max) | SPARSE NULL, |
| ntext231 | nvarchar (max) | SPARSE NULL, |
| ntext232 | nvarchar (max) | SPARSE NULL, |
| ntext233 | nvarchar (max) | SPARSE NULL, |
| ntext234 | nvarchar (max) | SPARSE NULL, |
| ntext235 | nvarchar (max) | SPARSE NULL, |
| ntext236 | nvarchar (max) | SPARSE NULL, |
| ntext237 | nvarchar (max) | SPARSE NULL, |
| ntext238 | nvarchar (max) | SPARSE NULL, |
| ntext239 | nvarchar (max) | SPARSE NULL, |
| ntext240 | nvarchar (max) | SPARSE NULL, |
| ntext241 | nvarchar (max) | SPARSE NULL, |
| ntext242 | nvarchar (max) | SPARSE NULL, |
| ntext243 | nvarchar (max) | SPARSE NULL, |
| ntext244 | nvarchar (max) | SPARSE NULL, |
| ntext245 | nvarchar (max) | SPARSE NULL, |
| ntext246 | nvarchar (max) | SPARSE NULL, |
| ntext247 | nvarchar (max) | SPARSE NULL, |
| ntext248 | nvarchar (max) | SPARSE NULL, |
| ntext249 | nvarchar (max) | SPARSE NULL, |
| ntext250 | nvarchar (max) | SPARSE NULL, |
| ntext251 | nvarchar (max) | SPARSE NULL, |
| ntext252 | nvarchar (max) | SPARSE NULL, |
| ntext253 | nvarchar (max) | SPARSE NULL, |
| ntext254 | nvarchar (max) | SPARSE NULL, |
| ntext255 | nvarchar (max) | SPARSE NULL, |
| ntext256 | nvarchar (max) | SPARSE NULL, |
| ntext257 | nvarchar (max) | SPARSE NULL, |

| | | |
|------------|----------------|--------------|
| nvarchar1 | nvarchar (255) | SPARSE NULL, |
| nvarchar2 | nvarchar (255) | SPARSE NULL, |
| nvarchar3 | nvarchar (255) | SPARSE NULL, |
| nvarchar4 | nvarchar (255) | SPARSE NULL, |
| nvarchar5 | nvarchar (255) | SPARSE NULL, |
| nvarchar6 | nvarchar (255) | SPARSE NULL, |
| nvarchar7 | nvarchar (255) | SPARSE NULL, |
| nvarchar8 | nvarchar (255) | SPARSE NULL, |
| nvarchar9 | nvarchar (255) | SPARSE NULL, |
| nvarchar10 | nvarchar (255) | SPARSE NULL, |
| nvarchar11 | nvarchar (255) | SPARSE NULL, |
| nvarchar12 | nvarchar (255) | SPARSE NULL, |
| nvarchar13 | nvarchar (255) | SPARSE NULL, |
| nvarchar14 | nvarchar (255) | SPARSE NULL, |
| nvarchar15 | nvarchar (255) | SPARSE NULL, |
| nvarchar16 | nvarchar (255) | SPARSE NULL, |
| nvarchar17 | nvarchar (255) | SPARSE NULL, |
| nvarchar18 | nvarchar (255) | SPARSE NULL, |
| nvarchar19 | nvarchar (255) | SPARSE NULL, |
| nvarchar20 | nvarchar (255) | SPARSE NULL, |
| nvarchar21 | nvarchar (255) | SPARSE NULL, |
| nvarchar22 | nvarchar (255) | SPARSE NULL, |
| nvarchar23 | nvarchar (255) | SPARSE NULL, |
| nvarchar24 | nvarchar (255) | SPARSE NULL, |
| nvarchar25 | nvarchar (255) | SPARSE NULL, |
| nvarchar26 | nvarchar (255) | SPARSE NULL, |
| nvarchar27 | nvarchar (255) | SPARSE NULL, |
| nvarchar28 | nvarchar (255) | SPARSE NULL, |
| nvarchar29 | nvarchar (255) | SPARSE NULL, |
| nvarchar30 | nvarchar (255) | SPARSE NULL, |
| nvarchar31 | nvarchar (255) | SPARSE NULL, |
| nvarchar32 | nvarchar (255) | SPARSE NULL, |
| nvarchar33 | nvarchar (255) | SPARSE NULL, |
| nvarchar34 | nvarchar (255) | SPARSE NULL, |
| nvarchar35 | nvarchar (255) | SPARSE NULL, |
| nvarchar36 | nvarchar (255) | SPARSE NULL, |
| nvarchar37 | nvarchar (255) | SPARSE NULL, |
| nvarchar38 | nvarchar (255) | SPARSE NULL, |
| nvarchar39 | nvarchar (255) | SPARSE NULL, |
| nvarchar40 | nvarchar (255) | SPARSE NULL, |
| nvarchar41 | nvarchar (255) | SPARSE NULL, |
| nvarchar42 | nvarchar (255) | SPARSE NULL, |
| nvarchar43 | nvarchar (255) | SPARSE NULL, |
| nvarchar44 | nvarchar (255) | SPARSE NULL, |
| nvarchar45 | nvarchar (255) | SPARSE NULL, |
| nvarchar46 | nvarchar (255) | SPARSE NULL, |
| nvarchar47 | nvarchar (255) | SPARSE NULL, |
| nvarchar48 | nvarchar (255) | SPARSE NULL, |
| nvarchar49 | nvarchar (255) | SPARSE NULL, |
| nvarchar50 | nvarchar (255) | SPARSE NULL, |
| nvarchar51 | nvarchar (255) | SPARSE NULL, |
| nvarchar52 | nvarchar (255) | SPARSE NULL, |
| nvarchar53 | nvarchar (255) | SPARSE NULL, |
| nvarchar54 | nvarchar (255) | SPARSE NULL, |

| | | |
|-------------|----------------|--------------|
| nvarchar55 | nvarchar (255) | SPARSE NULL, |
| nvarchar56 | nvarchar (255) | SPARSE NULL, |
| nvarchar57 | nvarchar (255) | SPARSE NULL, |
| nvarchar58 | nvarchar (255) | SPARSE NULL, |
| nvarchar59 | nvarchar (255) | SPARSE NULL, |
| nvarchar60 | nvarchar (255) | SPARSE NULL, |
| nvarchar61 | nvarchar (255) | SPARSE NULL, |
| nvarchar62 | nvarchar (255) | SPARSE NULL, |
| nvarchar63 | nvarchar (255) | SPARSE NULL, |
| nvarchar64 | nvarchar (255) | SPARSE NULL, |
| nvarchar65 | nvarchar (255) | SPARSE NULL, |
| nvarchar66 | nvarchar (255) | SPARSE NULL, |
| nvarchar67 | nvarchar (255) | SPARSE NULL, |
| nvarchar68 | nvarchar (255) | SPARSE NULL, |
| nvarchar69 | nvarchar (255) | SPARSE NULL, |
| nvarchar70 | nvarchar (255) | SPARSE NULL, |
| nvarchar71 | nvarchar (255) | SPARSE NULL, |
| nvarchar72 | nvarchar (255) | SPARSE NULL, |
| nvarchar73 | nvarchar (255) | SPARSE NULL, |
| nvarchar74 | nvarchar (255) | SPARSE NULL, |
| nvarchar75 | nvarchar (255) | SPARSE NULL, |
| nvarchar76 | nvarchar (255) | SPARSE NULL, |
| nvarchar77 | nvarchar (255) | SPARSE NULL, |
| nvarchar78 | nvarchar (255) | SPARSE NULL, |
| nvarchar79 | nvarchar (255) | SPARSE NULL, |
| nvarchar80 | nvarchar (255) | SPARSE NULL, |
| nvarchar81 | nvarchar (255) | SPARSE NULL, |
| nvarchar82 | nvarchar (255) | SPARSE NULL, |
| nvarchar83 | nvarchar (255) | SPARSE NULL, |
| nvarchar84 | nvarchar (255) | SPARSE NULL, |
| nvarchar85 | nvarchar (255) | SPARSE NULL, |
| nvarchar86 | nvarchar (255) | SPARSE NULL, |
| nvarchar87 | nvarchar (255) | SPARSE NULL, |
| nvarchar88 | nvarchar (255) | SPARSE NULL, |
| nvarchar89 | nvarchar (255) | SPARSE NULL, |
| nvarchar90 | nvarchar (255) | SPARSE NULL, |
| nvarchar91 | nvarchar (255) | SPARSE NULL, |
| nvarchar92 | nvarchar (255) | SPARSE NULL, |
| nvarchar93 | nvarchar (255) | SPARSE NULL, |
| nvarchar94 | nvarchar (255) | SPARSE NULL, |
| nvarchar95 | nvarchar (255) | SPARSE NULL, |
| nvarchar96 | nvarchar (255) | SPARSE NULL, |
| nvarchar97 | nvarchar (255) | SPARSE NULL, |
| nvarchar98 | nvarchar (255) | SPARSE NULL, |
| nvarchar99 | nvarchar (255) | SPARSE NULL, |
| nvarchar100 | nvarchar (255) | SPARSE NULL, |
| nvarchar101 | nvarchar (255) | SPARSE NULL, |
| nvarchar102 | nvarchar (255) | SPARSE NULL, |
| nvarchar103 | nvarchar (255) | SPARSE NULL, |
| nvarchar104 | nvarchar (255) | SPARSE NULL, |
| nvarchar105 | nvarchar (255) | SPARSE NULL, |
| nvarchar106 | nvarchar (255) | SPARSE NULL, |
| nvarchar107 | nvarchar (255) | SPARSE NULL, |
| nvarchar108 | nvarchar (255) | SPARSE NULL, |
| nvarchar109 | nvarchar (255) | SPARSE NULL, |
| nvarchar110 | nvarchar (255) | SPARSE NULL, |
| nvarchar111 | nvarchar (255) | SPARSE NULL, |
| nvarchar112 | nvarchar (255) | SPARSE NULL, |
| nvarchar113 | nvarchar (255) | SPARSE NULL, |

| | | |
|-------------|----------------|--------------|
| nvarchar114 | nvarchar (255) | SPARSE NULL, |
| nvarchar115 | nvarchar (255) | SPARSE NULL, |
| nvarchar116 | nvarchar (255) | SPARSE NULL, |
| nvarchar117 | nvarchar (255) | SPARSE NULL, |
| nvarchar118 | nvarchar (255) | SPARSE NULL, |
| nvarchar119 | nvarchar (255) | SPARSE NULL, |
| nvarchar120 | nvarchar (255) | SPARSE NULL, |
| nvarchar121 | nvarchar (255) | SPARSE NULL, |
| nvarchar122 | nvarchar (255) | SPARSE NULL, |
| nvarchar123 | nvarchar (255) | SPARSE NULL, |
| nvarchar124 | nvarchar (255) | SPARSE NULL, |
| nvarchar125 | nvarchar (255) | SPARSE NULL, |
| nvarchar126 | nvarchar (255) | SPARSE NULL, |
| nvarchar127 | nvarchar (255) | SPARSE NULL, |
| nvarchar128 | nvarchar (255) | SPARSE NULL, |
| nvarchar129 | nvarchar (255) | SPARSE NULL, |
| nvarchar130 | nvarchar (255) | SPARSE NULL, |
| nvarchar131 | nvarchar (255) | SPARSE NULL, |
| nvarchar132 | nvarchar (255) | SPARSE NULL, |
| nvarchar133 | nvarchar (255) | SPARSE NULL, |
| nvarchar134 | nvarchar (255) | SPARSE NULL, |
| nvarchar135 | nvarchar (255) | SPARSE NULL, |
| nvarchar136 | nvarchar (255) | SPARSE NULL, |
| nvarchar137 | nvarchar (255) | SPARSE NULL, |
| nvarchar138 | nvarchar (255) | SPARSE NULL, |
| nvarchar139 | nvarchar (255) | SPARSE NULL, |
| nvarchar140 | nvarchar (255) | SPARSE NULL, |
| nvarchar141 | nvarchar (255) | SPARSE NULL, |
| nvarchar142 | nvarchar (255) | SPARSE NULL, |
| nvarchar143 | nvarchar (255) | SPARSE NULL, |
| nvarchar144 | nvarchar (255) | SPARSE NULL, |
| nvarchar145 | nvarchar (255) | SPARSE NULL, |
| nvarchar146 | nvarchar (255) | SPARSE NULL, |
| nvarchar147 | nvarchar (255) | SPARSE NULL, |
| nvarchar148 | nvarchar (255) | SPARSE NULL, |
| nvarchar149 | nvarchar (255) | SPARSE NULL, |
| nvarchar150 | nvarchar (255) | SPARSE NULL, |
| nvarchar151 | nvarchar (255) | SPARSE NULL, |
| nvarchar152 | nvarchar (255) | SPARSE NULL, |
| nvarchar153 | nvarchar (255) | SPARSE NULL, |
| nvarchar154 | nvarchar (255) | SPARSE NULL, |
| nvarchar155 | nvarchar (255) | SPARSE NULL, |
| nvarchar156 | nvarchar (255) | SPARSE NULL, |
| nvarchar157 | nvarchar (255) | SPARSE NULL, |
| nvarchar158 | nvarchar (255) | SPARSE NULL, |
| nvarchar159 | nvarchar (255) | SPARSE NULL, |
| nvarchar160 | nvarchar (255) | SPARSE NULL, |
| nvarchar161 | nvarchar (255) | SPARSE NULL, |
| nvarchar162 | nvarchar (255) | SPARSE NULL, |
| nvarchar163 | nvarchar (255) | SPARSE NULL, |
| nvarchar164 | nvarchar (255) | SPARSE NULL, |
| nvarchar165 | nvarchar (255) | SPARSE NULL, |
| nvarchar166 | nvarchar (255) | SPARSE NULL, |
| nvarchar167 | nvarchar (255) | SPARSE NULL, |
| nvarchar168 | nvarchar (255) | SPARSE NULL, |
| nvarchar169 | nvarchar (255) | SPARSE NULL, |
| nvarchar170 | nvarchar (255) | SPARSE NULL, |
| nvarchar171 | nvarchar (255) | SPARSE NULL, |
| nvarchar172 | nvarchar (255) | SPARSE NULL, |

| | | |
|-------------|----------------|--------------|
| nvarchar173 | nvarchar (255) | SPARSE NULL, |
| nvarchar174 | nvarchar (255) | SPARSE NULL, |
| nvarchar175 | nvarchar (255) | SPARSE NULL, |
| nvarchar176 | nvarchar (255) | SPARSE NULL, |
| nvarchar177 | nvarchar (255) | SPARSE NULL, |
| nvarchar178 | nvarchar (255) | SPARSE NULL, |
| nvarchar179 | nvarchar (255) | SPARSE NULL, |
| nvarchar180 | nvarchar (255) | SPARSE NULL, |
| nvarchar181 | nvarchar (255) | SPARSE NULL, |
| nvarchar182 | nvarchar (255) | SPARSE NULL, |
| nvarchar183 | nvarchar (255) | SPARSE NULL, |
| nvarchar184 | nvarchar (255) | SPARSE NULL, |
| nvarchar185 | nvarchar (255) | SPARSE NULL, |
| nvarchar186 | nvarchar (255) | SPARSE NULL, |
| nvarchar187 | nvarchar (255) | SPARSE NULL, |
| nvarchar188 | nvarchar (255) | SPARSE NULL, |
| nvarchar189 | nvarchar (255) | SPARSE NULL, |
| nvarchar190 | nvarchar (255) | SPARSE NULL, |
| nvarchar191 | nvarchar (255) | SPARSE NULL, |
| nvarchar192 | nvarchar (255) | SPARSE NULL, |
| nvarchar193 | nvarchar (255) | SPARSE NULL, |
| nvarchar194 | nvarchar (255) | SPARSE NULL, |
| nvarchar195 | nvarchar (255) | SPARSE NULL, |
| nvarchar196 | nvarchar (255) | SPARSE NULL, |
| nvarchar197 | nvarchar (255) | SPARSE NULL, |
| nvarchar198 | nvarchar (255) | SPARSE NULL, |
| nvarchar199 | nvarchar (255) | SPARSE NULL, |
| nvarchar200 | nvarchar (255) | SPARSE NULL, |
| nvarchar201 | nvarchar (255) | SPARSE NULL, |
| nvarchar202 | nvarchar (255) | SPARSE NULL, |
| nvarchar203 | nvarchar (255) | SPARSE NULL, |
| nvarchar204 | nvarchar (255) | SPARSE NULL, |
| nvarchar205 | nvarchar (255) | SPARSE NULL, |
| nvarchar206 | nvarchar (255) | SPARSE NULL, |
| nvarchar207 | nvarchar (255) | SPARSE NULL, |
| nvarchar208 | nvarchar (255) | SPARSE NULL, |
| nvarchar209 | nvarchar (255) | SPARSE NULL, |
| nvarchar210 | nvarchar (255) | SPARSE NULL, |
| nvarchar211 | nvarchar (255) | SPARSE NULL, |
| nvarchar212 | nvarchar (255) | SPARSE NULL, |
| nvarchar213 | nvarchar (255) | SPARSE NULL, |
| nvarchar214 | nvarchar (255) | SPARSE NULL, |
| nvarchar215 | nvarchar (255) | SPARSE NULL, |
| nvarchar216 | nvarchar (255) | SPARSE NULL, |
| nvarchar217 | nvarchar (255) | SPARSE NULL, |
| nvarchar218 | nvarchar (255) | SPARSE NULL, |
| nvarchar219 | nvarchar (255) | SPARSE NULL, |
| nvarchar220 | nvarchar (255) | SPARSE NULL, |
| nvarchar221 | nvarchar (255) | SPARSE NULL, |
| nvarchar222 | nvarchar (255) | SPARSE NULL, |
| nvarchar223 | nvarchar (255) | SPARSE NULL, |
| nvarchar224 | nvarchar (255) | SPARSE NULL, |
| nvarchar225 | nvarchar (255) | SPARSE NULL, |
| nvarchar226 | nvarchar (255) | SPARSE NULL, |
| nvarchar227 | nvarchar (255) | SPARSE NULL, |
| nvarchar228 | nvarchar (255) | SPARSE NULL, |
| nvarchar229 | nvarchar (255) | SPARSE NULL, |
| nvarchar230 | nvarchar (255) | SPARSE NULL, |
| nvarchar231 | nvarchar (255) | SPARSE NULL, |

| | | |
|---------------|----------------|--------------|
| nvarchar232 | nvarchar (255) | SPARSE NULL, |
| nvarchar233 | nvarchar (255) | SPARSE NULL, |
| nvarchar234 | nvarchar (255) | SPARSE NULL, |
| nvarchar235 | nvarchar (255) | SPARSE NULL, |
| nvarchar236 | nvarchar (255) | SPARSE NULL, |
| nvarchar237 | nvarchar (255) | SPARSE NULL, |
| nvarchar238 | nvarchar (255) | SPARSE NULL, |
| nvarchar239 | nvarchar (255) | SPARSE NULL, |
| nvarchar240 | nvarchar (255) | SPARSE NULL, |
| nvarchar241 | nvarchar (255) | SPARSE NULL, |
| nvarchar242 | nvarchar (255) | SPARSE NULL, |
| nvarchar243 | nvarchar (255) | SPARSE NULL, |
| nvarchar244 | nvarchar (255) | SPARSE NULL, |
| nvarchar245 | nvarchar (255) | SPARSE NULL, |
| nvarchar246 | nvarchar (255) | SPARSE NULL, |
| nvarchar247 | nvarchar (255) | SPARSE NULL, |
| nvarchar248 | nvarchar (255) | SPARSE NULL, |
| nvarchar249 | nvarchar (255) | SPARSE NULL, |
| nvarchar250 | nvarchar (255) | SPARSE NULL, |
| nvarchar251 | nvarchar (255) | SPARSE NULL, |
| nvarchar252 | nvarchar (255) | SPARSE NULL, |
| nvarchar253 | nvarchar (255) | SPARSE NULL, |
| nvarchar254 | nvarchar (255) | SPARSE NULL, |
| nvarchar255 | nvarchar (255) | SPARSE NULL, |
| nvarchar256 | nvarchar (255) | SPARSE NULL, |
| nvarchar257 | nvarchar (255) | SPARSE NULL, |
| nvarchar258 | nvarchar (255) | SPARSE NULL, |
| nvarchar259 | nvarchar (255) | SPARSE NULL, |
| nvarchar260 | nvarchar (255) | SPARSE NULL, |
| nvarchar261 | nvarchar (255) | SPARSE NULL, |
| nvarchar262 | nvarchar (255) | SPARSE NULL, |
| sql_variant1 | sql_variant | SPARSE NULL, |
| sql_variant2 | sql_variant | SPARSE NULL, |
| sql_variant3 | sql_variant | SPARSE NULL, |
| sql_variant4 | sql_variant | SPARSE NULL, |
| sql_variant5 | sql_variant | SPARSE NULL, |
| sql_variant6 | sql_variant | SPARSE NULL, |
| sql_variant7 | sql_variant | SPARSE NULL, |
| sql_variant8 | sql_variant | SPARSE NULL, |
| sql_variant9 | sql_variant | SPARSE NULL, |
| sql_variant10 | sql_variant | SPARSE NULL, |
| sql_variant11 | sql_variant | SPARSE NULL, |
| sql_variant12 | sql_variant | SPARSE NULL, |
| sql_variant13 | sql_variant | SPARSE NULL, |
| sql_variant14 | sql_variant | SPARSE NULL, |
| sql_variant15 | sql_variant | SPARSE NULL, |
| sql_variant16 | sql_variant | SPARSE NULL, |
| sql_variant17 | sql_variant | SPARSE NULL, |
| sql_variant18 | sql_variant | SPARSE NULL, |
| sql_variant19 | sql_variant | SPARSE NULL, |
| sql_variant20 | sql_variant | SPARSE NULL, |
| sql_variant21 | sql_variant | SPARSE NULL, |
| sql_variant22 | sql_variant | SPARSE NULL, |
| sql_variant23 | sql_variant | SPARSE NULL, |
| sql_variant24 | sql_variant | SPARSE NULL, |
| sql_variant25 | sql_variant | SPARSE NULL, |
| sql_variant26 | sql_variant | SPARSE NULL, |
| sql_variant27 | sql_variant | SPARSE NULL, |
| sql_variant28 | sql_variant | SPARSE NULL, |

| | | |
|---------------|-------------|--------------|
| sql_variant29 | sql_variant | SPARSE NULL, |
| sql_variant30 | sql_variant | SPARSE NULL, |
| sql_variant31 | sql_variant | SPARSE NULL, |
| sql_variant32 | sql_variant | SPARSE NULL, |
| sql_variant33 | sql_variant | SPARSE NULL, |
| sql_variant34 | sql_variant | SPARSE NULL, |
| sql_variant35 | sql_variant | SPARSE NULL, |
| sql_variant36 | sql_variant | SPARSE NULL, |
| sql_variant37 | sql_variant | SPARSE NULL, |
| sql_variant38 | sql_variant | SPARSE NULL, |
| sql_variant39 | sql_variant | SPARSE NULL, |
| sql_variant40 | sql_variant | SPARSE NULL, |
| sql_variant41 | sql_variant | SPARSE NULL, |
| sql_variant42 | sql_variant | SPARSE NULL, |
| sql_variant43 | sql_variant | SPARSE NULL, |
| sql_variant44 | sql_variant | SPARSE NULL, |
| sql_variant45 | sql_variant | SPARSE NULL, |
| sql_variant46 | sql_variant | SPARSE NULL, |
| sql_variant47 | sql_variant | SPARSE NULL, |
| sql_variant48 | sql_variant | SPARSE NULL, |
| sql_variant49 | sql_variant | SPARSE NULL, |
| sql_variant50 | sql_variant | SPARSE NULL, |
| sql_variant51 | sql_variant | SPARSE NULL, |
| sql_variant52 | sql_variant | SPARSE NULL, |
| sql_variant53 | sql_variant | SPARSE NULL, |
| sql_variant54 | sql_variant | SPARSE NULL, |
| sql_variant55 | sql_variant | SPARSE NULL, |
| sql_variant56 | sql_variant | SPARSE NULL, |
| sql_variant57 | sql_variant | SPARSE NULL, |
| sql_variant58 | sql_variant | SPARSE NULL, |
| sql_variant59 | sql_variant | SPARSE NULL, |
| sql_variant60 | sql_variant | SPARSE NULL, |
| sql_variant61 | sql_variant | SPARSE NULL, |
| sql_variant62 | sql_variant | SPARSE NULL, |
| sql_variant63 | sql_variant | SPARSE NULL, |
| sql_variant64 | sql_variant | SPARSE NULL, |
| sql_variant65 | sql_variant | SPARSE NULL, |
| sql_variant66 | sql_variant | SPARSE NULL, |
| sql_variant67 | sql_variant | SPARSE NULL, |
| sql_variant68 | sql_variant | SPARSE NULL, |
| sql_variant69 | sql_variant | SPARSE NULL, |
| sql_variant70 | sql_variant | SPARSE NULL, |
| sql_variant71 | sql_variant | SPARSE NULL, |
| sql_variant72 | sql_variant | SPARSE NULL, |
| sql_variant73 | sql_variant | SPARSE NULL, |
| sql_variant74 | sql_variant | SPARSE NULL, |
| sql_variant75 | sql_variant | SPARSE NULL, |
| sql_variant76 | sql_variant | SPARSE NULL, |
| sql_variant77 | sql_variant | SPARSE NULL, |
| sql_variant78 | sql_variant | SPARSE NULL, |
| sql_variant79 | sql_variant | SPARSE NULL, |
| sql_variant80 | sql_variant | SPARSE NULL, |
| sql_variant81 | sql_variant | SPARSE NULL, |
| sql_variant82 | sql_variant | SPARSE NULL, |
| sql_variant83 | sql_variant | SPARSE NULL, |
| sql_variant84 | sql_variant | SPARSE NULL, |
| sql_variant85 | sql_variant | SPARSE NULL, |
| sql_variant86 | sql_variant | SPARSE NULL, |
| sql_variant87 | sql_variant | SPARSE NULL, |

| | | |
|----------------|-------------|--------------|
| sql_variant88 | sql_variant | SPARSE NULL, |
| sql_variant89 | sql_variant | SPARSE NULL, |
| sql_variant90 | sql_variant | SPARSE NULL, |
| sql_variant91 | sql_variant | SPARSE NULL, |
| sql_variant92 | sql_variant | SPARSE NULL, |
| sql_variant93 | sql_variant | SPARSE NULL, |
| sql_variant94 | sql_variant | SPARSE NULL, |
| sql_variant95 | sql_variant | SPARSE NULL, |
| sql_variant96 | sql_variant | SPARSE NULL, |
| sql_variant97 | sql_variant | SPARSE NULL, |
| sql_variant98 | sql_variant | SPARSE NULL, |
| sql_variant99 | sql_variant | SPARSE NULL, |
| sql_variant100 | sql_variant | SPARSE NULL, |
| sql_variant101 | sql_variant | SPARSE NULL, |
| sql_variant102 | sql_variant | SPARSE NULL, |
| sql_variant103 | sql_variant | SPARSE NULL, |
| sql_variant104 | sql_variant | SPARSE NULL, |
| sql_variant105 | sql_variant | SPARSE NULL, |
| sql_variant106 | sql_variant | SPARSE NULL, |
| sql_variant107 | sql_variant | SPARSE NULL, |
| sql_variant108 | sql_variant | SPARSE NULL, |
| sql_variant109 | sql_variant | SPARSE NULL, |
| sql_variant110 | sql_variant | SPARSE NULL, |
| sql_variant111 | sql_variant | SPARSE NULL, |
| sql_variant112 | sql_variant | SPARSE NULL, |
| sql_variant113 | sql_variant | SPARSE NULL, |
| sql_variant114 | sql_variant | SPARSE NULL, |
| sql_variant115 | sql_variant | SPARSE NULL, |
| sql_variant116 | sql_variant | SPARSE NULL, |
| sql_variant117 | sql_variant | SPARSE NULL, |
| sql_variant118 | sql_variant | SPARSE NULL, |
| sql_variant119 | sql_variant | SPARSE NULL, |
| sql_variant120 | sql_variant | SPARSE NULL, |
| sql_variant121 | sql_variant | SPARSE NULL, |
| sql_variant122 | sql_variant | SPARSE NULL, |
| sql_variant123 | sql_variant | SPARSE NULL, |
| sql_variant124 | sql_variant | SPARSE NULL, |
| sql_variant125 | sql_variant | SPARSE NULL, |
| sql_variant126 | sql_variant | SPARSE NULL, |
| sql_variant127 | sql_variant | SPARSE NULL, |
| sql_variant128 | sql_variant | SPARSE NULL, |
| sql_variant129 | sql_variant | SPARSE NULL, |
| sql_variant130 | sql_variant | SPARSE NULL, |
| sql_variant131 | sql_variant | SPARSE NULL, |
| sql_variant132 | sql_variant | SPARSE NULL, |
| sql_variant133 | sql_variant | SPARSE NULL, |
| sql_variant134 | sql_variant | SPARSE NULL, |
| sql_variant135 | sql_variant | SPARSE NULL, |
| sql_variant136 | sql_variant | SPARSE NULL, |
| sql_variant137 | sql_variant | SPARSE NULL, |
| sql_variant138 | sql_variant | SPARSE NULL, |
| sql_variant139 | sql_variant | SPARSE NULL, |
| sql_variant140 | sql_variant | SPARSE NULL, |
| sql_variant141 | sql_variant | SPARSE NULL, |
| sql_variant142 | sql_variant | SPARSE NULL, |
| sql_variant143 | sql_variant | SPARSE NULL, |
| sql_variant144 | sql_variant | SPARSE NULL, |
| sql_variant145 | sql_variant | SPARSE NULL, |
| sql_variant146 | sql_variant | SPARSE NULL, |

| | | |
|----------------|-------------|--------------|
| sql_variant147 | sql_variant | SPARSE NULL, |
| sql_variant148 | sql_variant | SPARSE NULL, |
| sql_variant149 | sql_variant | SPARSE NULL, |
| sql_variant150 | sql_variant | SPARSE NULL, |
| sql_variant151 | sql_variant | SPARSE NULL, |
| sql_variant152 | sql_variant | SPARSE NULL, |
| sql_variant153 | sql_variant | SPARSE NULL, |
| sql_variant154 | sql_variant | SPARSE NULL, |
| sql_variant155 | sql_variant | SPARSE NULL, |
| sql_variant156 | sql_variant | SPARSE NULL, |
| sql_variant157 | sql_variant | SPARSE NULL, |
| sql_variant158 | sql_variant | SPARSE NULL, |
| sql_variant159 | sql_variant | SPARSE NULL, |
| sql_variant160 | sql_variant | SPARSE NULL, |
| sql_variant161 | sql_variant | SPARSE NULL, |
| sql_variant162 | sql_variant | SPARSE NULL, |
| sql_variant163 | sql_variant | SPARSE NULL, |
| sql_variant164 | sql_variant | SPARSE NULL, |
| sql_variant165 | sql_variant | SPARSE NULL, |
| sql_variant166 | sql_variant | SPARSE NULL, |
| sql_variant167 | sql_variant | SPARSE NULL, |
| sql_variant168 | sql_variant | SPARSE NULL, |
| sql_variant169 | sql_variant | SPARSE NULL, |
| sql_variant170 | sql_variant | SPARSE NULL, |
| sql_variant171 | sql_variant | SPARSE NULL, |
| sql_variant172 | sql_variant | SPARSE NULL, |
| sql_variant173 | sql_variant | SPARSE NULL, |
| sql_variant174 | sql_variant | SPARSE NULL, |
| sql_variant175 | sql_variant | SPARSE NULL, |
| sql_variant176 | sql_variant | SPARSE NULL, |
| sql_variant177 | sql_variant | SPARSE NULL, |
| sql_variant178 | sql_variant | SPARSE NULL, |
| sql_variant179 | sql_variant | SPARSE NULL, |
| sql_variant180 | sql_variant | SPARSE NULL, |
| sql_variant181 | sql_variant | SPARSE NULL, |
| sql_variant182 | sql_variant | SPARSE NULL, |
| sql_variant183 | sql_variant | SPARSE NULL, |
| sql_variant184 | sql_variant | SPARSE NULL, |
| sql_variant185 | sql_variant | SPARSE NULL, |
| sql_variant186 | sql_variant | SPARSE NULL, |
| sql_variant187 | sql_variant | SPARSE NULL, |
| sql_variant188 | sql_variant | SPARSE NULL, |
| sql_variant189 | sql_variant | SPARSE NULL, |
| sql_variant190 | sql_variant | SPARSE NULL, |
| sql_variant191 | sql_variant | SPARSE NULL, |
| sql_variant192 | sql_variant | SPARSE NULL, |
| sql_variant193 | sql_variant | SPARSE NULL, |
| sql_variant194 | sql_variant | SPARSE NULL, |
| sql_variant195 | sql_variant | SPARSE NULL, |
| sql_variant196 | sql_variant | SPARSE NULL, |
| sql_variant197 | sql_variant | SPARSE NULL, |
| sql_variant198 | sql_variant | SPARSE NULL, |
| sql_variant199 | sql_variant | SPARSE NULL, |
| sql_variant200 | sql_variant | SPARSE NULL, |
| sql_variant201 | sql_variant | SPARSE NULL, |
| sql_variant202 | sql_variant | SPARSE NULL, |
| sql_variant203 | sql_variant | SPARSE NULL, |
| sql_variant204 | sql_variant | SPARSE NULL, |
| sql_variant205 | sql_variant | SPARSE NULL, |

| | | |
|-------------------|------------------|--------------|
| sql_variant206 | sql_variant | SPARSE NULL, |
| sql_variant207 | sql_variant | SPARSE NULL, |
| sql_variant208 | sql_variant | SPARSE NULL, |
| sql_variant209 | sql_variant | SPARSE NULL, |
| sql_variant210 | sql_variant | SPARSE NULL, |
| sql_variant211 | sql_variant | SPARSE NULL, |
| sql_variant212 | sql_variant | SPARSE NULL, |
| sql_variant213 | sql_variant | SPARSE NULL, |
| sql_variant214 | sql_variant | SPARSE NULL, |
| sql_variant215 | sql_variant | SPARSE NULL, |
| sql_variant216 | sql_variant | SPARSE NULL, |
| sql_variant217 | sql_variant | SPARSE NULL, |
| sql_variant218 | sql_variant | SPARSE NULL, |
| sql_variant219 | sql_variant | SPARSE NULL, |
| sql_variant220 | sql_variant | SPARSE NULL, |
| sql_variant221 | sql_variant | SPARSE NULL, |
| sql_variant222 | sql_variant | SPARSE NULL, |
| sql_variant223 | sql_variant | SPARSE NULL, |
| sql_variant224 | sql_variant | SPARSE NULL, |
| sql_variant225 | sql_variant | SPARSE NULL, |
| sql_variant226 | sql_variant | SPARSE NULL, |
| sql_variant227 | sql_variant | SPARSE NULL, |
| sql_variant228 | sql_variant | SPARSE NULL, |
| sql_variant229 | sql_variant | SPARSE NULL, |
| sql_variant230 | sql_variant | SPARSE NULL, |
| sql_variant231 | sql_variant | SPARSE NULL, |
| sql_variant232 | sql_variant | SPARSE NULL, |
| sql_variant233 | sql_variant | SPARSE NULL, |
| sql_variant234 | sql_variant | SPARSE NULL, |
| sql_variant235 | sql_variant | SPARSE NULL, |
| sql_variant236 | sql_variant | SPARSE NULL, |
| sql_variant237 | sql_variant | SPARSE NULL, |
| sql_variant238 | sql_variant | SPARSE NULL, |
| sql_variant239 | sql_variant | SPARSE NULL, |
| sql_variant240 | sql_variant | SPARSE NULL, |
| sql_variant241 | sql_variant | SPARSE NULL, |
| sql_variant242 | sql_variant | SPARSE NULL, |
| sql_variant243 | sql_variant | SPARSE NULL, |
| sql_variant244 | sql_variant | SPARSE NULL, |
| sql_variant245 | sql_variant | SPARSE NULL, |
| sql_variant246 | sql_variant | SPARSE NULL, |
| sql_variant247 | sql_variant | SPARSE NULL, |
| sql_variant248 | sql_variant | SPARSE NULL, |
| sql_variant249 | sql_variant | SPARSE NULL, |
| sql_variant250 | sql_variant | SPARSE NULL, |
| sql_variant251 | sql_variant | SPARSE NULL, |
| sql_variant252 | sql_variant | SPARSE NULL, |
| sql_variant253 | sql_variant | SPARSE NULL, |
| sql_variant254 | sql_variant | SPARSE NULL, |
| sql_variant255 | sql_variant | SPARSE NULL, |
| sql_variant256 | sql_variant | SPARSE NULL, |
| sql_variant257 | sql_variant | SPARSE NULL, |
| sql_variant258 | sql_variant | SPARSE NULL, |
| sql_variant259 | sql_variant | SPARSE NULL, |
| sql_variant260 | sql_variant | SPARSE NULL, |
| sql_variant261 | sql_variant | SPARSE NULL, |
| sql_variant262 | sql_variant | SPARSE NULL, |
| uniqueidentifier1 | uniqueidentifier | SPARSE NULL, |
| uniqueidentifier2 | uniqueidentifier | SPARSE NULL, |

| | | | |
|--------------------|------------------|--------|-------|
| uniqueidentifier3 | uniqueidentifier | SPARSE | NULL, |
| uniqueidentifier4 | uniqueidentifier | SPARSE | NULL, |
| uniqueidentifier5 | uniqueidentifier | SPARSE | NULL, |
| uniqueidentifier6 | uniqueidentifier | SPARSE | NULL, |
| uniqueidentifier7 | uniqueidentifier | SPARSE | NULL, |
| uniqueidentifier8 | uniqueidentifier | SPARSE | NULL, |
| uniqueidentifier9 | uniqueidentifier | SPARSE | NULL, |
| uniqueidentifier10 | uniqueidentifier | SPARSE | NULL, |
| uniqueidentifier11 | uniqueidentifier | SPARSE | NULL, |
| uniqueidentifier12 | uniqueidentifier | SPARSE | NULL, |
| uniqueidentifier13 | uniqueidentifier | SPARSE | NULL, |
| uniqueidentifier14 | uniqueidentifier | SPARSE | NULL, |
| uniqueidentifier15 | uniqueidentifier | SPARSE | NULL, |
| uniqueidentifier16 | uniqueidentifier | SPARSE | NULL, |
| uniqueidentifier17 | uniqueidentifier | SPARSE | NULL, |
| uniqueidentifier18 | uniqueidentifier | SPARSE | NULL, |
| uniqueidentifier19 | uniqueidentifier | SPARSE | NULL, |
| uniqueidentifier20 | uniqueidentifier | SPARSE | NULL, |
| uniqueidentifier21 | uniqueidentifier | SPARSE | NULL, |
| uniqueidentifier22 | uniqueidentifier | SPARSE | NULL, |
| uniqueidentifier23 | uniqueidentifier | SPARSE | NULL, |
| uniqueidentifier24 | uniqueidentifier | SPARSE | NULL, |
| uniqueidentifier25 | uniqueidentifier | SPARSE | NULL, |
| uniqueidentifier26 | uniqueidentifier | SPARSE | NULL, |
| uniqueidentifier27 | uniqueidentifier | SPARSE | NULL, |
| uniqueidentifier28 | uniqueidentifier | SPARSE | NULL, |
| uniqueidentifier29 | uniqueidentifier | SPARSE | NULL, |
| uniqueidentifier30 | uniqueidentifier | SPARSE | NULL, |
| uniqueidentifier31 | uniqueidentifier | SPARSE | NULL, |
| uniqueidentifier32 | uniqueidentifier | SPARSE | NULL, |
| uniqueidentifier33 | uniqueidentifier | SPARSE | NULL, |
| uniqueidentifier34 | uniqueidentifier | SPARSE | NULL, |
| uniqueidentifier35 | uniqueidentifier | SPARSE | NULL, |
| uniqueidentifier36 | uniqueidentifier | SPARSE | NULL, |
| uniqueidentifier37 | uniqueidentifier | SPARSE | NULL, |
| uniqueidentifier38 | uniqueidentifier | SPARSE | NULL, |
| uniqueidentifier39 | uniqueidentifier | SPARSE | NULL, |
| uniqueidentifier40 | uniqueidentifier | SPARSE | NULL, |
| uniqueidentifier41 | uniqueidentifier | SPARSE | NULL, |
| uniqueidentifier42 | uniqueidentifier | SPARSE | NULL, |
| uniqueidentifier43 | uniqueidentifier | SPARSE | NULL, |
| uniqueidentifier44 | uniqueidentifier | SPARSE | NULL, |
| uniqueidentifier45 | uniqueidentifier | SPARSE | NULL, |
| uniqueidentifier46 | uniqueidentifier | SPARSE | NULL, |
| uniqueidentifier47 | uniqueidentifier | SPARSE | NULL, |
| uniqueidentifier48 | uniqueidentifier | SPARSE | NULL, |
| uniqueidentifier49 | uniqueidentifier | SPARSE | NULL, |
| uniqueidentifier50 | uniqueidentifier | SPARSE | NULL, |
| uniqueidentifier51 | uniqueidentifier | SPARSE | NULL, |
| uniqueidentifier52 | uniqueidentifier | SPARSE | NULL, |
| uniqueidentifier53 | uniqueidentifier | SPARSE | NULL, |
| uniqueidentifier54 | uniqueidentifier | SPARSE | NULL, |
| uniqueidentifier55 | uniqueidentifier | SPARSE | NULL, |
| uniqueidentifier56 | uniqueidentifier | SPARSE | NULL, |
| uniqueidentifier57 | uniqueidentifier | SPARSE | NULL, |
| uniqueidentifier58 | uniqueidentifier | SPARSE | NULL, |
| uniqueidentifier59 | uniqueidentifier | SPARSE | NULL, |
| uniqueidentifier60 | uniqueidentifier | SPARSE | NULL, |
| uniqueidentifier61 | uniqueidentifier | SPARSE | NULL, |

| | | | |
|---------------------|------------------|--------|-------|
| uniqueidentifier62 | uniqueidentifier | SPARSE | NULL, |
| uniqueidentifier63 | uniqueidentifier | SPARSE | NULL, |
| uniqueidentifier64 | uniqueidentifier | SPARSE | NULL, |
| uniqueidentifier65 | uniqueidentifier | SPARSE | NULL, |
| uniqueidentifier66 | uniqueidentifier | SPARSE | NULL, |
| uniqueidentifier67 | uniqueidentifier | SPARSE | NULL, |
| uniqueidentifier68 | uniqueidentifier | SPARSE | NULL, |
| uniqueidentifier69 | uniqueidentifier | SPARSE | NULL, |
| uniqueidentifier70 | uniqueidentifier | SPARSE | NULL, |
| uniqueidentifier71 | uniqueidentifier | SPARSE | NULL, |
| uniqueidentifier72 | uniqueidentifier | SPARSE | NULL, |
| uniqueidentifier73 | uniqueidentifier | SPARSE | NULL, |
| uniqueidentifier74 | uniqueidentifier | SPARSE | NULL, |
| uniqueidentifier75 | uniqueidentifier | SPARSE | NULL, |
| uniqueidentifier76 | uniqueidentifier | SPARSE | NULL, |
| uniqueidentifier77 | uniqueidentifier | SPARSE | NULL, |
| uniqueidentifier78 | uniqueidentifier | SPARSE | NULL, |
| uniqueidentifier79 | uniqueidentifier | SPARSE | NULL, |
| uniqueidentifier80 | uniqueidentifier | SPARSE | NULL, |
| uniqueidentifier81 | uniqueidentifier | SPARSE | NULL, |
| uniqueidentifier82 | uniqueidentifier | SPARSE | NULL, |
| uniqueidentifier83 | uniqueidentifier | SPARSE | NULL, |
| uniqueidentifier84 | uniqueidentifier | SPARSE | NULL, |
| uniqueidentifier85 | uniqueidentifier | SPARSE | NULL, |
| uniqueidentifier86 | uniqueidentifier | SPARSE | NULL, |
| uniqueidentifier87 | uniqueidentifier | SPARSE | NULL, |
| uniqueidentifier88 | uniqueidentifier | SPARSE | NULL, |
| uniqueidentifier89 | uniqueidentifier | SPARSE | NULL, |
| uniqueidentifier90 | uniqueidentifier | SPARSE | NULL, |
| uniqueidentifier91 | uniqueidentifier | SPARSE | NULL, |
| uniqueidentifier92 | uniqueidentifier | SPARSE | NULL, |
| uniqueidentifier93 | uniqueidentifier | SPARSE | NULL, |
| uniqueidentifier94 | uniqueidentifier | SPARSE | NULL, |
| uniqueidentifier95 | uniqueidentifier | SPARSE | NULL, |
| uniqueidentifier96 | uniqueidentifier | SPARSE | NULL, |
| uniqueidentifier97 | uniqueidentifier | SPARSE | NULL, |
| uniqueidentifier98 | uniqueidentifier | SPARSE | NULL, |
| uniqueidentifier99 | uniqueidentifier | SPARSE | NULL, |
| uniqueidentifier100 | uniqueidentifier | SPARSE | NULL, |
| uniqueidentifier101 | uniqueidentifier | SPARSE | NULL, |
| uniqueidentifier102 | uniqueidentifier | SPARSE | NULL, |
| uniqueidentifier103 | uniqueidentifier | SPARSE | NULL, |
| uniqueidentifier104 | uniqueidentifier | SPARSE | NULL, |
| uniqueidentifier105 | uniqueidentifier | SPARSE | NULL, |
| uniqueidentifier106 | uniqueidentifier | SPARSE | NULL, |
| uniqueidentifier107 | uniqueidentifier | SPARSE | NULL, |
| uniqueidentifier108 | uniqueidentifier | SPARSE | NULL, |
| uniqueidentifier109 | uniqueidentifier | SPARSE | NULL, |
| uniqueidentifier110 | uniqueidentifier | SPARSE | NULL, |
| uniqueidentifier111 | uniqueidentifier | SPARSE | NULL, |
| uniqueidentifier112 | uniqueidentifier | SPARSE | NULL, |
| uniqueidentifier113 | uniqueidentifier | SPARSE | NULL, |
| uniqueidentifier114 | uniqueidentifier | SPARSE | NULL, |
| uniqueidentifier115 | uniqueidentifier | SPARSE | NULL, |
| uniqueidentifier116 | uniqueidentifier | SPARSE | NULL, |
| uniqueidentifier117 | uniqueidentifier | SPARSE | NULL, |
| uniqueidentifier118 | uniqueidentifier | SPARSE | NULL, |
| uniqueidentifier119 | uniqueidentifier | SPARSE | NULL, |
| uniqueidentifier120 | uniqueidentifier | SPARSE | NULL, |

| | | | |
|---------------------|------------------|--------|-------|
| uniqueidentifier121 | uniqueidentifier | SPARSE | NULL, |
| uniqueidentifier122 | uniqueidentifier | SPARSE | NULL, |
| uniqueidentifier123 | uniqueidentifier | SPARSE | NULL, |
| uniqueidentifier124 | uniqueidentifier | SPARSE | NULL, |
| uniqueidentifier125 | uniqueidentifier | SPARSE | NULL, |
| uniqueidentifier126 | uniqueidentifier | SPARSE | NULL, |
| uniqueidentifier127 | uniqueidentifier | SPARSE | NULL, |
| uniqueidentifier128 | uniqueidentifier | SPARSE | NULL, |
| uniqueidentifier129 | uniqueidentifier | SPARSE | NULL, |
| uniqueidentifier130 | uniqueidentifier | SPARSE | NULL, |
| uniqueidentifier131 | uniqueidentifier | SPARSE | NULL, |
| uniqueidentifier132 | uniqueidentifier | SPARSE | NULL, |
| uniqueidentifier133 | uniqueidentifier | SPARSE | NULL, |
| uniqueidentifier134 | uniqueidentifier | SPARSE | NULL, |
| uniqueidentifier135 | uniqueidentifier | SPARSE | NULL, |
| uniqueidentifier136 | uniqueidentifier | SPARSE | NULL, |
| uniqueidentifier137 | uniqueidentifier | SPARSE | NULL, |
| uniqueidentifier138 | uniqueidentifier | SPARSE | NULL, |
| uniqueidentifier139 | uniqueidentifier | SPARSE | NULL, |
| uniqueidentifier140 | uniqueidentifier | SPARSE | NULL, |
| uniqueidentifier141 | uniqueidentifier | SPARSE | NULL, |
| uniqueidentifier142 | uniqueidentifier | SPARSE | NULL, |
| uniqueidentifier143 | uniqueidentifier | SPARSE | NULL, |
| uniqueidentifier144 | uniqueidentifier | SPARSE | NULL, |
| uniqueidentifier145 | uniqueidentifier | SPARSE | NULL, |
| uniqueidentifier146 | uniqueidentifier | SPARSE | NULL, |
| uniqueidentifier147 | uniqueidentifier | SPARSE | NULL, |
| uniqueidentifier148 | uniqueidentifier | SPARSE | NULL, |
| uniqueidentifier149 | uniqueidentifier | SPARSE | NULL, |
| uniqueidentifier150 | uniqueidentifier | SPARSE | NULL, |
| uniqueidentifier151 | uniqueidentifier | SPARSE | NULL, |
| uniqueidentifier152 | uniqueidentifier | SPARSE | NULL, |
| uniqueidentifier153 | uniqueidentifier | SPARSE | NULL, |
| uniqueidentifier154 | uniqueidentifier | SPARSE | NULL, |
| uniqueidentifier155 | uniqueidentifier | SPARSE | NULL, |
| uniqueidentifier156 | uniqueidentifier | SPARSE | NULL, |
| uniqueidentifier157 | uniqueidentifier | SPARSE | NULL, |
| uniqueidentifier158 | uniqueidentifier | SPARSE | NULL, |
| uniqueidentifier159 | uniqueidentifier | SPARSE | NULL, |
| uniqueidentifier160 | uniqueidentifier | SPARSE | NULL, |
| uniqueidentifier161 | uniqueidentifier | SPARSE | NULL, |
| uniqueidentifier162 | uniqueidentifier | SPARSE | NULL, |
| uniqueidentifier163 | uniqueidentifier | SPARSE | NULL, |
| uniqueidentifier164 | uniqueidentifier | SPARSE | NULL, |
| uniqueidentifier165 | uniqueidentifier | SPARSE | NULL, |
| uniqueidentifier166 | uniqueidentifier | SPARSE | NULL, |
| uniqueidentifier167 | uniqueidentifier | SPARSE | NULL, |
| uniqueidentifier168 | uniqueidentifier | SPARSE | NULL, |
| uniqueidentifier169 | uniqueidentifier | SPARSE | NULL, |
| uniqueidentifier170 | uniqueidentifier | SPARSE | NULL, |
| uniqueidentifier171 | uniqueidentifier | SPARSE | NULL, |
| uniqueidentifier172 | uniqueidentifier | SPARSE | NULL, |
| uniqueidentifier173 | uniqueidentifier | SPARSE | NULL, |
| uniqueidentifier174 | uniqueidentifier | SPARSE | NULL, |
| uniqueidentifier175 | uniqueidentifier | SPARSE | NULL, |
| uniqueidentifier176 | uniqueidentifier | SPARSE | NULL, |
| uniqueidentifier177 | uniqueidentifier | SPARSE | NULL, |
| uniqueidentifier178 | uniqueidentifier | SPARSE | NULL, |
| uniqueidentifier179 | uniqueidentifier | SPARSE | NULL, |

| | | | |
|---------------------|------------------|--------|-------|
| uniqueidentifier180 | uniqueidentifier | SPARSE | NULL, |
| uniqueidentifier181 | uniqueidentifier | SPARSE | NULL, |
| uniqueidentifier182 | uniqueidentifier | SPARSE | NULL, |
| uniqueidentifier183 | uniqueidentifier | SPARSE | NULL, |
| uniqueidentifier184 | uniqueidentifier | SPARSE | NULL, |
| uniqueidentifier185 | uniqueidentifier | SPARSE | NULL, |
| uniqueidentifier186 | uniqueidentifier | SPARSE | NULL, |
| uniqueidentifier187 | uniqueidentifier | SPARSE | NULL, |
| uniqueidentifier188 | uniqueidentifier | SPARSE | NULL, |
| uniqueidentifier189 | uniqueidentifier | SPARSE | NULL, |
| uniqueidentifier190 | uniqueidentifier | SPARSE | NULL, |
| uniqueidentifier191 | uniqueidentifier | SPARSE | NULL, |
| uniqueidentifier192 | uniqueidentifier | SPARSE | NULL, |
| uniqueidentifier193 | uniqueidentifier | SPARSE | NULL, |
| uniqueidentifier194 | uniqueidentifier | SPARSE | NULL, |
| uniqueidentifier195 | uniqueidentifier | SPARSE | NULL, |
| uniqueidentifier196 | uniqueidentifier | SPARSE | NULL, |
| uniqueidentifier197 | uniqueidentifier | SPARSE | NULL, |
| uniqueidentifier198 | uniqueidentifier | SPARSE | NULL, |
| uniqueidentifier199 | uniqueidentifier | SPARSE | NULL, |
| uniqueidentifier200 | uniqueidentifier | SPARSE | NULL, |
| uniqueidentifier201 | uniqueidentifier | SPARSE | NULL, |
| uniqueidentifier202 | uniqueidentifier | SPARSE | NULL, |
| uniqueidentifier203 | uniqueidentifier | SPARSE | NULL, |
| uniqueidentifier204 | uniqueidentifier | SPARSE | NULL, |
| uniqueidentifier205 | uniqueidentifier | SPARSE | NULL, |
| uniqueidentifier206 | uniqueidentifier | SPARSE | NULL, |
| uniqueidentifier207 | uniqueidentifier | SPARSE | NULL, |
| uniqueidentifier208 | uniqueidentifier | SPARSE | NULL, |
| uniqueidentifier209 | uniqueidentifier | SPARSE | NULL, |
| uniqueidentifier210 | uniqueidentifier | SPARSE | NULL, |
| uniqueidentifier211 | uniqueidentifier | SPARSE | NULL, |
| uniqueidentifier212 | uniqueidentifier | SPARSE | NULL, |
| uniqueidentifier213 | uniqueidentifier | SPARSE | NULL, |
| uniqueidentifier214 | uniqueidentifier | SPARSE | NULL, |
| uniqueidentifier215 | uniqueidentifier | SPARSE | NULL, |
| uniqueidentifier216 | uniqueidentifier | SPARSE | NULL, |
| uniqueidentifier217 | uniqueidentifier | SPARSE | NULL, |
| uniqueidentifier218 | uniqueidentifier | SPARSE | NULL, |
| uniqueidentifier219 | uniqueidentifier | SPARSE | NULL, |
| uniqueidentifier220 | uniqueidentifier | SPARSE | NULL, |
| uniqueidentifier221 | uniqueidentifier | SPARSE | NULL, |
| uniqueidentifier222 | uniqueidentifier | SPARSE | NULL, |
| uniqueidentifier223 | uniqueidentifier | SPARSE | NULL, |
| uniqueidentifier224 | uniqueidentifier | SPARSE | NULL, |
| uniqueidentifier225 | uniqueidentifier | SPARSE | NULL, |
| uniqueidentifier226 | uniqueidentifier | SPARSE | NULL, |
| uniqueidentifier227 | uniqueidentifier | SPARSE | NULL, |
| uniqueidentifier228 | uniqueidentifier | SPARSE | NULL, |
| uniqueidentifier229 | uniqueidentifier | SPARSE | NULL, |
| uniqueidentifier230 | uniqueidentifier | SPARSE | NULL, |
| uniqueidentifier231 | uniqueidentifier | SPARSE | NULL, |
| uniqueidentifier232 | uniqueidentifier | SPARSE | NULL, |
| uniqueidentifier233 | uniqueidentifier | SPARSE | NULL, |
| uniqueidentifier234 | uniqueidentifier | SPARSE | NULL, |
| uniqueidentifier235 | uniqueidentifier | SPARSE | NULL, |
| uniqueidentifier236 | uniqueidentifier | SPARSE | NULL, |
| uniqueidentifier237 | uniqueidentifier | SPARSE | NULL, |
| uniqueidentifier238 | uniqueidentifier | SPARSE | NULL, |

| | | | |
|---------------------|------------------|--------|-------|
| uniqueidentifier239 | uniqueidentifier | SPARSE | NULL, |
| uniqueidentifier240 | uniqueidentifier | SPARSE | NULL, |
| uniqueidentifier241 | uniqueidentifier | SPARSE | NULL, |
| uniqueidentifier242 | uniqueidentifier | SPARSE | NULL, |
| uniqueidentifier243 | uniqueidentifier | SPARSE | NULL, |
| uniqueidentifier244 | uniqueidentifier | SPARSE | NULL, |
| uniqueidentifier245 | uniqueidentifier | SPARSE | NULL, |
| uniqueidentifier246 | uniqueidentifier | SPARSE | NULL, |
| uniqueidentifier247 | uniqueidentifier | SPARSE | NULL, |
| uniqueidentifier248 | uniqueidentifier | SPARSE | NULL, |
| uniqueidentifier249 | uniqueidentifier | SPARSE | NULL, |
| uniqueidentifier250 | uniqueidentifier | SPARSE | NULL, |
| uniqueidentifier251 | uniqueidentifier | SPARSE | NULL, |
| uniqueidentifier252 | uniqueidentifier | SPARSE | NULL, |
| uniqueidentifier253 | uniqueidentifier | SPARSE | NULL, |
| uniqueidentifier254 | uniqueidentifier | SPARSE | NULL, |
| uniqueidentifier255 | uniqueidentifier | SPARSE | NULL, |
| uniqueidentifier256 | uniqueidentifier | SPARSE | NULL, |
| uniqueidentifier257 | uniqueidentifier | SPARSE | NULL, |
| uniqueidentifier258 | uniqueidentifier | SPARSE | NULL, |
| uniqueidentifier259 | uniqueidentifier | SPARSE | NULL, |
| uniqueidentifier260 | uniqueidentifier | SPARSE | NULL, |
| uniqueidentifier261 | uniqueidentifier | SPARSE | NULL, |
| uniqueidentifier262 | uniqueidentifier | SPARSE | NULL, |
| uniqueidentifier263 | uniqueidentifier | SPARSE | NULL, |
| uniqueidentifier264 | uniqueidentifier | SPARSE | NULL, |
| uniqueidentifier265 | uniqueidentifier | SPARSE | NULL, |
| uniqueidentifier266 | uniqueidentifier | SPARSE | NULL, |
| uniqueidentifier267 | uniqueidentifier | SPARSE | NULL, |
| uniqueidentifier268 | uniqueidentifier | SPARSE | NULL, |
| uniqueidentifier269 | uniqueidentifier | SPARSE | NULL, |
| uniqueidentifier270 | uniqueidentifier | SPARSE | NULL, |
| uniqueidentifier271 | uniqueidentifier | SPARSE | NULL, |
| uniqueidentifier272 | uniqueidentifier | SPARSE | NULL, |
| uniqueidentifier273 | uniqueidentifier | SPARSE | NULL, |
| uniqueidentifier274 | uniqueidentifier | SPARSE | NULL, |
| uniqueidentifier275 | uniqueidentifier | SPARSE | NULL, |
| uniqueidentifier276 | uniqueidentifier | SPARSE | NULL, |
| uniqueidentifier277 | uniqueidentifier | SPARSE | NULL, |
| uniqueidentifier278 | uniqueidentifier | SPARSE | NULL, |
| uniqueidentifier279 | uniqueidentifier | SPARSE | NULL, |
| uniqueidentifier280 | uniqueidentifier | SPARSE | NULL, |
| uniqueidentifier281 | uniqueidentifier | SPARSE | NULL, |
| uniqueidentifier282 | uniqueidentifier | SPARSE | NULL, |
| uniqueidentifier283 | uniqueidentifier | SPARSE | NULL, |
| uniqueidentifier284 | uniqueidentifier | SPARSE | NULL, |
| uniqueidentifier285 | uniqueidentifier | SPARSE | NULL, |
| uniqueidentifier286 | uniqueidentifier | SPARSE | NULL, |
| uniqueidentifier287 | uniqueidentifier | SPARSE | NULL, |
| uniqueidentifier288 | uniqueidentifier | SPARSE | NULL, |
| uniqueidentifier289 | uniqueidentifier | SPARSE | NULL, |
| uniqueidentifier290 | uniqueidentifier | SPARSE | NULL, |
| uniqueidentifier291 | uniqueidentifier | SPARSE | NULL, |
| uniqueidentifier292 | uniqueidentifier | SPARSE | NULL, |
| uniqueidentifier293 | uniqueidentifier | SPARSE | NULL, |
| uniqueidentifier294 | uniqueidentifier | SPARSE | NULL, |
| uniqueidentifier295 | uniqueidentifier | SPARSE | NULL, |
| uniqueidentifier296 | uniqueidentifier | SPARSE | NULL, |
| uniqueidentifier297 | uniqueidentifier | SPARSE | NULL, |

```

uniqueidentifier298      uniqueidentifier  SPARSE  NULL,
uniqueidentifier299      uniqueidentifier  SPARSE  NULL,
uniqueidentifier300      uniqueidentifier  SPARSE  NULL,
uniqueidentifier301      uniqueidentifier  SPARSE  NULL,
uniqueidentifier302      uniqueidentifier  SPARSE  NULL,
uniqueidentifier303      uniqueidentifier  SPARSE  NULL,
uniqueidentifier304      uniqueidentifier  SPARSE  NULL,
uniqueidentifier305      uniqueidentifier  SPARSE  NULL,
uniqueidentifier306      uniqueidentifier  SPARSE  NULL,
uniqueidentifier307      uniqueidentifier  SPARSE  NULL,
uniqueidentifier308      uniqueidentifier  SPARSE  NULL,
uniqueidentifier309      uniqueidentifier  SPARSE  NULL,
uniqueidentifier310      uniqueidentifier  SPARSE  NULL,
uniqueidentifier311      uniqueidentifier  SPARSE  NULL,
uniqueidentifier312      uniqueidentifier  SPARSE  NULL,
uniqueidentifier313      uniqueidentifier  SPARSE  NULL,
uniqueidentifier314      uniqueidentifier  SPARSE  NULL,
uniqueidentifier315      uniqueidentifier  SPARSE  NULL,
uniqueidentifier316      uniqueidentifier  SPARSE  NULL,
uniqueidentifier317      uniqueidentifier  SPARSE  NULL,
uniqueidentifier318      uniqueidentifier  SPARSE  NULL,
uniqueidentifier319      uniqueidentifier  SPARSE  NULL,
uniqueidentifier320      uniqueidentifier  SPARSE  NULL,
uniqueidentifier321      uniqueidentifier  SPARSE  NULL,
uniqueidentifier322      uniqueidentifier  SPARSE  NULL,
uniqueidentifier323      uniqueidentifier  SPARSE  NULL,
uniqueidentifier324      uniqueidentifier  SPARSE  NULL,
uniqueidentifier325      uniqueidentifier  SPARSE  NULL,
uniqueidentifier326      uniqueidentifier  SPARSE  NULL,
uniqueidentifier327      uniqueidentifier  SPARSE  NULL,
uniqueidentifier328      uniqueidentifier  SPARSE  NULL,
uniqueidentifier329      uniqueidentifier  SPARSE  NULL,
uniqueidentifier330      uniqueidentifier  SPARSE  NULL,
uniqueidentifier331      uniqueidentifier  SPARSE  NULL,
uniqueidentifier332      uniqueidentifier  SPARSE  NULL,
uniqueidentifier333      uniqueidentifier  SPARSE  NULL,
uniqueidentifier334      uniqueidentifier  SPARSE  NULL,
uniqueidentifier335      uniqueidentifier  SPARSE  NULL,
uniqueidentifier336      uniqueidentifier  SPARSE  NULL,
uniqueidentifier337      uniqueidentifier  SPARSE  NULL,
uniqueidentifier338      uniqueidentifier  SPARSE  NULL,
uniqueidentifier339      uniqueidentifier  SPARSE  NULL,
uniqueidentifier340      uniqueidentifier  SPARSE  NULL,
uniqueidentifier341      uniqueidentifier  SPARSE  NULL,
uniqueidentifier342      uniqueidentifier  SPARSE  NULL,
uniqueidentifier343      uniqueidentifier  SPARSE  NULL,
uniqueidentifier344      uniqueidentifier  SPARSE  NULL,
uniqueidentifier345      uniqueidentifier  SPARSE  NULL,
uniqueidentifier346      uniqueidentifier  SPARSE  NULL,
uniqueidentifier347      uniqueidentifier  SPARSE  NULL,
uniqueidentifier348      uniqueidentifier  SPARSE  NULL,
uniqueidentifier349      uniqueidentifier  SPARSE  NULL,
uniqueidentifier350      uniqueidentifier  SPARSE  NULL,
geography1              varbinary(8000)  SPARSE  NULL,
geography2              varbinary(8000)  SPARSE  NULL,
tp_ColumnSet            xml  COLUMN_SET FOR ALL_SPARSE_COLUMNS NULL
);

```

tp_Id: The identifier for the list item, uniquely identifying it within the **AllUserData** table.

tp_ListId: The list identifier of the list (1) or document library containing the list item.

tp_SiteId: The site collection identifier of the site collection containing the list item.

tp_RowOrdinal: The zero-based ordinal index of this row in the set of rows representing the list item. Additional rows are used to represent list items that have more application-defined columns of one or more data types than can fit in a single row in the **AllUserData** table.

tp_Version: A counter used for internal conflict detection that is incremented any time a change is made to the list item. Because of the mapping of application properties to the generic columns schema in this table, changes to application schema as well as property values can affect a version increment.

tp_Author: The user identifier for the user who created the list item.

tp_Editor: The user identifier for the user who last edited the list item.

tp_Modified: A date and time value in UTC format specifying when this list item was last modified.

tp_Created: A date and time value in UTC format specifying when this list item was created.

tp_Ordering: A concatenation of time stamp values in yyyyMMddHHmmss format, specifying the threading structure of the list items in a legacy discussion board list (1) (a list (1) with a **List Base Type** (section [2.2.1.2.11](#)) of three). For list items in all other types of lists (1), this parameter MUST be NULL.

tp_ThreadIndex: A binary structure specifying the list item's position within a legacy discussion board list (1) (a list (1) with a **List Base Type** of three). For list items in all other types of lists (1), this parameter MUST be NULL.

tp_HasAttachment: A bit set to one if the list item has an attachment associated with it; otherwise, it is set to zero.

tp_ModerationStatus: A **Moderation Status** value (section [2.2.1.2.13](#)) indicating the current moderation approval status of the list item.

tp_IsCurrent: A bit set to one if this is a current version of this list item; otherwise, it is set to zero.

tp_ItemOrder: A value used to calculate the relative order in which to view the list item when displayed with other list items from the same list (1).

tp_InstanceID: If this list item is associated with a particular instance of a recurring meeting, this is the integer identifier of that instance. For all other list items, this MUST be NULL.

tp_GUID: A value uniquely identifying this list item.

tp_CopySource: The URL used as a source for the list item. If this list item was not copied from a source list item, this value MUST be NULL.

tp_HasCopyDestinations: This bit is set to one if destination locations for the list item to be copied to have been set. If the list item does not have a destination location set, this value MUST be zero.

tp_AuditFlags: An **Audit Flags** value (section [2.2.2.1](#)) determining the operations to be tracked on this list item.

tp_InheritAuditFlags: An **Audit Flags** value for the operations to be tracked on this list item, as determined from parent container **Audit Flags** settings.

tp_Size: The sum of the size, in bytes, of the content of application-schema columns in the list item. This does not include the size of the document stream for list items that have an associated document stream.

tp_WorkflowVersion: If the list item is part of a workflow (2), this stores an integer denoting the state of this list item within that workflow (2). Otherwise, this value MUST be NULL.

tp_WorkflowInstanceID: A **Workflow Identifier** value (section [2.2.1.1.16](#)) for the currently active **workflow instance** on this list item. If the list item is not part of a workflow (2), this value MUST be NULL.

tp_ParentId: The document identifier (2) of the item's parent container. For example, the document identifier (2) of the folder or document library containing this subfolder or item. This value MUST NOT be NULL, because every item but one has a parent container. A special empty document identifier (2), '00000000-0000-0000-0000-000000000000', marks the parent container of the topmost item (the root site (2)) in the site collection.

tp_DocId: The document identifier (2) of the list item.

tp_DeleteTransactionId: An identifier for use with an implementation-specific deleted items **Recycle Bin**. This MUST equal 0x if the list item is nondeleted.

tp_ContentTypeId: The binary identifier of the content type associated with the list item.

tContentTypeId is defined in section [2.2.1.1.1](#).

tp_Level: A publishing level value specifying the publishing status of this version of the list item.

tp_IsCurrentVersion: A bit indicating whether this row corresponds to a current version or a historical version of the list item. This value MUST be one if this row contains a current version. Otherwise, it MUST be zero.

tp_UIVersion: The UI version number associated with this list item. The default value of **tp_UIVersion** is 512, which corresponds to a displayed version of 1.0.

tp_CalculatedVersion: This contains the UI version number if this is a historical version of the list item. This MUST be zero if the list item is a current version.

tp_UIVersionString: A calculated column containing the value of the **tp_UIVersion** column as a displayed version string.

tp_DraftOwnerId: The identifier of the user who created this list item as a draft. This value is non-NULL only if the list item exists and is a draft version.

tp_CheckoutUserId: The identifier of the user who checked out this list item. This value is non-NULL only if the list item exists and is checked out.

tp_AppAuthor: The app principal identifier of the app principal who created the list item.

tp_AppEditor: The app principal identifier of the app principal who last edited the list item.

The next nine columns are duplicated a number of times within the table definition. This is indicated using a suffix, #, which is replaced with a numeral in the column names, described as follows. The number of times each column is duplicated varies and is indicated for each column. Each group of columns is dedicated to hold application-defined fields of a different data type, described as follows.

bit#: Columns for application-defined fields that hold values of type **bit**. The 1000 columns are named **bit1** to **bit1000**. If the column does not contain data, this value MUST be NULL.

datetime#: Columns for application-defined fields that hold values of type **datetime**. The 550 columns are named **datetime1** to **datetime550**. If the column does not contain data, this value MUST be NULL.

float#: Columns for application-defined fields that hold values of type **float**. The 550 columns are named **float1** to **float550**. If the column does not contain data, this value MUST be NULL.

int#: Columns for application-defined fields that hold values of type **int**. The 750 columns are named **int1** to **int750**. If the column does not contain data, this value MUST be NULL.

ntext#: Columns for application-defined fields that hold values of type **nvarchar(max)**. The 262 columns are named **ntext1** to **ntext262**. If the column does not contain data, this value MUST be NULL.

nvarchar#: Columns for application-defined fields that hold values of type **nvarchar**. The 262 columns are named **nvarchar1** to **nvarchar262**. If the column does not contain data, this value MUST be NULL.

sql_variant#: Columns for application-defined fields that hold values of type **sql_variant**. The 262 columns are named **sql_variant1** to **sql_variant262**. If the column does not contain data, this value MUST be NULL.

uniqueidentifier#: Columns for application-defined fields that hold values of type **uniqueidentifier**. The 350 columns are named **uniqueidentifier1** to **uniqueidentifier350**. If the column does not contain data, this value MUST be NULL.

geography#: Columns for application-defined fields that hold values of type **varbinary(8000)**. The 2 columns are named **geography1** and **geography2**. If the column does not contain data, this value MUST be NULL.

tp_ColumnSet: An XML representation of the non-NULL values from the columns **bit#**, **datetime#**, **float#**, **int#**, **ntext#**, **nvarchar#**, **sql_variant#**, **uniqueidentifier#**, and **geography#**.

2.2.6.3 Docs View

The **Docs View** reflects all rows in the table **AllDocs** (section [2.2.6.1](#)) that are not deleted (that is, all table rows where **DeleteTransactionId** is equal to 0x). **Docs View** records include items that have a URL, such as files, folders, lists, document libraries, and sites, referred to collectively as documents.

See **AllDocs** for the T-SQL syntax description of the structure of this view.

2.2.6.4 GroupMembership Table

The **GroupMembership Table** stores a list of the principals that are members of each site group in a site collection. The **GroupMembership Table** is defined using T-SQL syntax, as follows.

```
TABLE GroupMembership(  
    SiteId                uniqueidentifier NOT NULL,  
    GroupId               int                NOT NULL,  
    MemberId              int                NOT NULL  
);
```

SiteId: The Site Collection Identifier (section [2.2.1.1.9](#)) of the site collection containing the principals and site groups.

GroupId: The group identifier of the site group that the principal specified by **MemberId** is a member of.

MemberId: The User Identifier (section [2.2.1.1.13](#)) of a principal that is a member of the site group specified by **GroupId**.

2.2.6.5 Sec_SiteGroupsView

The **Sec_SiteGroupsView** is a view into site group information with one site group per row. Site groups available through this view are owned by a user or domain group, or by a site group.

If a user or domain group owns the site group, the **OwnerIsUser** bit is set to one, and the **GroupID**, **GroupName**, **GroupDescription**, **GroupSiteID**, **GroupOwner** and **GroupOwnerIsUser** fields are set to NULL. If the site group is owned by a site group, the **OwnerIsUser** bit is set to zero, and the **UserID**, **UserSID**, **UserName**, **UserLogin**, **UserEmail**, **UserNotes**, **UserSiteAdmin** and **UserDomainGroup** are set to NULL.

The **Sec_SiteGroupsView** is defined using T-SQL syntax, as follows.

```
VIEW Sec_SiteGroupsView(  
    ID                                int,  
    Title                             nvarchar(255),  
    Description                        nvarchar(512),  
    SiteWebId                         uniqueidentifier,  
    Owner                              int,  
    OwnerIsUser                       bit,  
    OwnerGlobal                       bit,  
    Type                              tinyint,  
    Global                            bit,  
    SiteID                             uniqueidentifier,  
    UserID                             int,  
    UserSID                           varbinary(512),  
    UserName                          nvarchar(255),  
    UserLogin                          nvarchar(255),  
    UserEmail                         nvarchar(255),  
    UserNotes                         nvarchar(1023),  
    UserSiteAdmin                    bit,  
    UserDomainGroup                  bit,  
    UserFlags                         int,  
    GroupID                           int,  
    GroupName                        nvarchar(255),  
    GroupDescription                  nvarchar(512),  
    GroupSiteID                      uniqueidentifier,  
    GroupOwner                       int,  
    GroupOwnerIsUser                 bit,  
    DLAlias                          nvarchar(128),  
    DLErrorMessage                   nvarchar(512),  
    DLFlags                          int,  
    DLJobId                          int,  
    DLArchives                       varchar(4000),  
    RequestEmail                     nvarchar(255),  
    Flags                            int  
);
```

ID: The identifier for the site group. This parameter MUST NOT be NULL.

Title: The user-friendly display name for the site group. This parameter MUST NOT be NULL.

Description: The site group description.

SiteWebId: The **Site Collection Identifier** (section [2.2.1.1.9](#)) of the site collection that contains the site group information. This value is the same as returned in **SiteId**. For non-user-owned groups, this column name will be **WebId**. This parameter MUST NOT be NULL.

Owner: The **User Identifier** (section [2.2.1.1.13](#)) or **Site Group Identifier** (section [2.2.1.1.10](#)) of the site group owner. This parameter MUST NOT be NULL.

OwnerIsUser: A bit flag specifying whether the site group owner is a user or a site group. When the value in the **Owner field** is a **User Identifier** for a user or a domain group, the **OwnerIsUser** flag MUST be set to one. When the value in the **Owner field** is a **Site Group Identifier**, the **OwnerIsUser** flag MUST be set to zero. This parameter MUST NOT be NULL.

OwnerGlobal: A bit flag specifying whether the view contains ownership information for a user or domain group, or for a site group.

When the owner is a site group, the **OwnerGlobal** flag MUST be set to one and the **GroupID**, **GroupName**, **GroupDescription**, **GroupSiteID**, **GroupOwner** and **GroupOwnerIsUser** fields MUST be populated with information from the site group owning this site group, while the **UserID**, **UserSID**, **UserName**, **UserLogin**, **UserEmail**, **UserNotes**, **UserSiteAdmin** and **UserDomainGroup** fields MUST be NULL.

When the owner is a user or domain group, the **OwnerGlobal** flag MUST be set to zero and the **UserID**, **UserSID**, **UserName**, **UserLogin**, **UserEmail**, **UserNotes**, **UserSiteAdmin** and **UserDomainGroup** fields MUST be populated with information from the user or domain group owning this site group, while the **GroupID**, **GroupName**, **GroupDescription**, **GroupSiteID**, **GroupOwner** and **GroupOwnerIsUser** fields MUST be NULL.

Type: This value MUST be zero.

Global: This value MUST be one.

SiteID: The **Site Collection Identifier** of the site collection. This parameter MUST NOT be NULL.

UserID: The **User Identifier** of the owner of the site group. This MUST be NULL when the site group owner is a site group.

UserSID: The **SystemId** of the owner of the site group. This MUST be NULL when the site group owner is a site group.

UserName: The user-friendly name of the owner of the site group. This MUST be NULL when the site group owner is a site group.

UserLogin: The login name of the owner of the site group. This MUST be NULL when the site group owner is a site group.

UserEmail: The e-mail address of the owner of the site group. This MUST be NULL when the site group owner is a site group.

UserNotes: The notes associated with the owner of the site group. This MUST be NULL when the site group owner is a site group.

UserSiteAdmin: A bit flag specifying whether the site group owner is a site collection administrator. When the site group owner is a site collection administrator, the **UserSiteAdmin** flag MUST be set to one. If the user or domain group owner of the site group is not a site collection administrator, the **UserSiteAdmin** flag MUST be set to zero. This MUST be NULL when the site group owner is a site group.

UserDomainGroup: A bit flag specifying whether the site group owner is a domain group. When the site group owner is a domain group, the flag MUST be set to one. When the site group owner is a user or domain group, the flag MUST be set to zero. This flag MUST be NULL when the site group owner is a site group.

UserFlags: Contains the **User Information Flags** value (section [2.2.2.12](#)) describing the owner of the site group. This MUST be NULL when the site group owner is a site group.

GroupID: The **Site Group Identifier** of the owner of this site group. This MUST be NULL when the site group owner is a user or domain group.

GroupName: The user-friendly name of the owner of this site group. This MUST be NULL when the site group owner is a user or domain group.

GroupDescription: The description of the owner of this site group. This MUST be NULL when the site group owner is a user or domain group.

GroupSiteID: The **Site Collection Identifier** of the site collection containing the owner of this site group. This MUST be NULL when the site group owner is a user or domain group.

GroupOwner: The **User Identifier** or **Site Group Identifier** of the owner of the site group that owns this site group. This MUST be NULL when the site group owner is a user or domain group, because only an owner that is a site group can have a group owner.

GroupOwnerIsUser: A bit flag specifying whether the site group that owns this site group is in turn owned by a user or domain group, or by a site group. When the owner of the site group that owns this site group is a user or domain group, the **GroupOwnerIsUser** flag MUST be set to one. This flag MUST be set to zero when the site group owner is owned by a site group. This MUST be NULL when the site group owner is a user or domain group.

DLAlias: The e-mail distribution list address for the site group. This value MUST be NULL if the group (2) has no e-mail distribution list address.

DLErrorMessage: Contains the most recent error message returned by an asynchronous e-mail distribution list operation, if any.

DLFlags: Contains a bit field of status flags for the e-mail distribution list associated with this site group. This parameter MUST be one of the values listed in the following table.

| Value | Description |
|------------|---|
| 0x00000000 | None. |
| 0x00000001 | Pending - If this bit is set, the e-mail distribution list associated with this site group currently has a pending asynchronous operation. |
| 0x00000002 | Dirty - If this bit is set, the e-mail distribution list associated with this group (2) is dirty . The e-mail distribution list is considered dirty when A) an asynchronous operation is pending, and B) the site group has been modified since the asynchronous operation was initiated. A dirty e-mail distribution list needs to have its status and membership synchronized as soon as |

| Value | Description |
|------------|---|
| | the pending operation completes (whether it succeeds or fails). |
| 0x00000004 | PendingJobIsRename - The type of the currently pending asynchronous e-mail distribution list operation, if any. When this bit is set, the pending operation is a Rename. When the bit is not set, it is a Create operation. |

DLJobId: Contains the job identifier of the currently pending asynchronous e-mail distribution list operation, or zero if there is no pending operation.

DLArchives: An array of bytes containing a list of pairs of **List Identifiers** (section [2.2.1.1.5](#)) defining additional lists, which are recipients of e-mail sent to the e-mail distribution list via the address in **DLAlias**. Each Identifier **MUST** be stored as a string, with commas separating the list's parent site **Document Identifier** (section [2.2.1.1.2](#)) and the **List Identifier**, and with semicolons following each pair.

RequestEmail: The e-mail address used to send a request to join or depart a site group.

Flags: Contains the membership permissions bit field for the site group. This parameter **MUST NOT** be NULL and **MUST** be one of the values listed in the following table.

| Value | Description |
|------------|---|
| 0x00000000 | Allow anyone to view the membership of the site group. |
| 0x00000001 | Only allow members of the site group to view the membership. |
| 0x00000002 | Allow members of the site group to edit the membership of the site group. |
| 0x00000004 | Allow users to request membership in this site group, and allow users to request to leave the site group. All requests MUST be sent to the e-mail address specified by RequestEmail. |
| 0x00000008 | Automatically accept user requests to join or leave the site group. This bit MUST be set only when the bit 0x00000004 is also set. |

2.2.6.6 AllSites Table

The **AllSites** table stores information about site collections. The table is defined using T-SQL syntax, as follows.

```
TABLE AllSites (
    FullUrl                nvarchar(260) DEFAULT N'',
    Id                     uniqueidentifier,
    RootWebId              uniqueidentifier,
    ClientTag               smallint, DEFAULT 0 NOT NULL,
    NextUserOrGroupId      int,
    NextAppPrincipalId     int NOT NULL DEFAULT 1,
    OwnerID                int,
    SecondaryContactID     int,
    Subscribed              bit,
    TimeCreated             datetime,
    Deleted                 bit,
    UsersCount              int                DEFAULT ((1)),
    BWUsed                  bigint,
    DiskUsed                bigint,
    SecondStageDiskUsed     bigint,
```

```

QuotaTemplateID          smallint,
DiskQuota                bigint,
UserQuota                int,
DiskWarning              bigint,
DiskWarned              datetime,
CurrentResourceUsage     float DEFAULT 0 NOT NULL,
AverageResourceUsage     float DEFAULT 0 NOT NULL,
ResourceUsageWarning     float DEFAULT 0 NOT NULL,
ResourceUsageMaximum     float DEFAULT 0 NOT NULL,
BitFlags                 int,
SecurityVersion          bigint,
DenyPermMask            tPermMask DEFAULT 0 NOT NULL,
CertificationDate        datetime,
DeadWebNotifyCount       smallint,
PortalURL                nvarchar(260),
PortalName               nvarchar(255),
LastContentChange        datetime DEFAULT (getutcdate()),
LastSecurityChange       datetime DEFAULT (getutcdate()),
AuditFlags               int,
InheritAuditFlags        int,
UserInfoListId           uniqueidentifier,
UserIsActiveFieldRowOrdinal int,
UserIsActiveFieldColumnName nvarchar(64),
UserAccountDirectoryPath nvarchar(512),

HashKey                  binary(16),
DomainGroupMapVersion    bigint,
DomainGroupMapCacheVersion bigint DEFAULT ((-1)),
DomainGroupMapCache      varbinary(max),
HostHeader               nvarchar(128),
SiteUrls                 varbinary(max),
SubscriptionId           varbinary(16),
RbsCollectionId          int DEFAULT 0 NOT NULL,
LastSMRequest            datetime DEFAULT NULL,
PlatformVersion          nvarchar(64) DEFAULT NULL,
UpgradeFlags             int DEFAULT 1 NOT NULL,

SourceSiteId             uniqueidentifier SPARSE NULL,
ExpirationDate           datetime SPARSE NULL,
EvalSiteId               uniqueidentifier SPARSE NULL,
UpgradeReminderDate      datetime,
SubscriptionName         nvarchar(48) DEFAULT NULL,
AppSiteDomainId          varchar(6) DEFAULT NULL,
NextAppWebDomainId       binary(4) DEFAULT NULL

```

```
);
```

FullUrl: The absolute URL of the site collection.

Id: The **Site Collection Identifier** of the site collection. Used only during upgrade.

RootWebId: The site identifier of the site configured as the root site in the site collection.

ClientTag: A number that represents the state of the application files of the site.

NextUserOrGroupId: An integer value that is incremented when a new user or permission level is added to the site collection. Indicates the value of the next user or **Site Group Identifier** (section [2.2.1.1.10](#)) to be used.

NextAppPrincipalId: An integer value that is incremented when a new app principal is added to the site collection. Indicates the value of the next app principal integer identifier in the site collection to be used.

OwnerID: The user identifier of the user who owns the site collection.

SecondaryContactID: The user identifier of the user who is the secondary contact of the site collection.

Subscribed: A bit set to 1 to indicate that the site collection has been subscribed for implementation-specific notifications.

TimeCreated: The date and time in UTC format when the site collection was created.

Deleted: A bit set to 1 indicates that a delete operation has been initiated on the site collection and it has been scheduled for deletion.

UsersCount: The number of users in the site collection.

BWUsed: The number of sites in the site collection actively used. Serves as an implementation-specific, usage-reporting feature.

DiskUsed: The size, in bytes, of disk space used to store content in the site collection.

SecondStageDiskUsed: The size, in bytes, of disk space used to store the second-stage trash bin items for the site collection.

QuotaTemplateID: The identifier of a quota template used to set the disk quota for the site collection.

DiskQuota: The maximum size, in bytes, of disk space that can be allocated by the site collection. A value of 0 indicates that no limit is set.

UserQuota: The maximum number of users that the site collection can contain. A value of 0 indicates that no limit is set.

DiskWarning: The size, in bytes, of disk space that can be allocated on the site collection before the disk warning email is sent. A value of 0 indicates that no warning email will be sent.

DiskWarned: A date and time value in UTC format set to the last time a warning was sent to the site collection owner about disk usage, if any.

CurrentResourceUsage: A float that specifies the current resource usage of the site collection up to the current date.

AverageResourceUsage: A float that specifies the average resource usage of the site collection over the configured period of days.

ResourceUsageWarning: A float that specifies the current resource usage warning setting. If the current resource usage exceeds it, a warning notification will be sent.

ResourceUsageMaximum: A float that specifies the maximum resource usage of the site collection.

BitFlags: A **Site Collection Flags** (section [2.2.2.9](#)) value describing the site collection.

SecurityVersion: A version number that is incremented when changes are made to the site collection's permissions.

DenyPermMask: A **WSS Rights Mask** (section [2.2.2.15](#)) specifying the rights to deny to the current user.

CertificationDate: The date and time, in UTC format, when the site collection was last confirmed by its owner as being used.

DeadWebNotifyCount: The number of times that a notification was sent to the site collection owner that the site collection will be deleted if the owner does not certify it as being used. (See the **CertificationDate** column.)

PortalURL: The URL of an external **Web site (1)** designated as the portal of the site (1). This is an implementation-specific navigation links feature.

PortalName: The name of the external Web site (1) referenced in the **PortalURL** column. Used for display in implementation-specific navigation features.

LastContentChange: The date and time value, in UTC format, that the content of the site collection was last changed.

LastSecurityChange: The date and time value, in UTC format, when the permissions on the site collection were last changed.

AuditFlags: An **Audit Flags** (section [2.2.2.1](#)) value specifying the operations to be audited that are set directly on the site collection.

InheritAuditFlags: An **Audit Flags** (section [2.2.2.1](#)) value specifying the operations to be audited on the specified object that are inherited.

UserInfoListId: The **List Identifier** (section [2.2.1.1.5](#)) of a list holding user information for the site collection.

UserIsActiveFieldRowOrdinal: The ordinal of the column in the list identified by **UserInfoListId** that tracks whether a user is an active user in the site collection.

UserIsActiveFieldColumnName: The name of the column in the list identified by **UserInfoListId** that tracks whether a user is an active user in the site collection.

UserAccountDirectoryPath: A provider-specific user account path. The value is used for validation of added user accounts if the site collection flags bit 0x00080000 is set in the **BitFlags** column.

HashKey: A hash key associated with the site collection.

DomainGroupMapVersion: The version of the domain group map.

DomainGroupMapCacheVersion: The version of the domain group map cache.

DomainGroupMapCache: A binary serialization of the domain group map cache, containing a mapping of external groups to the permission levels of which they are members (1).

HostHeader: When used in **host header** mode, this contains the host header string associated with the site collection's Web application (1).

SubscriptionId: The GUID of the implementation-specific subscription feature for the site collection.

RbsCollectionId: The identifier of the remote BLOB storage collection associated with the site collection, or zero if remote BLOB storage is not configured for this database.

LastSMRequest: The date and time value, in UTC format, when the storage metrics information for the site collection was last requested.

PlatformVersion: The string that represents the current version of the site collection from the platform compatibility perspective.

UpgradeFlags: The site collection upgrade flags (see section [2.2.2.10](#)) for this site collection.

SourceSiteId: The site collection identifier of the site collection that was used to create the upgrade evaluation site collection. A non-NULL value for this column implies that the site collection is an upgrade evaluation site collection.

ExpirationDate: The date and time value in UTC format, after which the upgrade evaluation site collection will be automatically deleted.

EvalSiteId: The site collection identifier of the upgrade evaluation site collection that was created using the site collection.

UpgradeReminderDate: The upgrade reminder date of the site collection.

SubscriptionName: The name corresponding to the **site subscription identifier** of the implementation-specific subscription for the requested site collection.

AppSiteDomainId: The **app site domain identifier**.

NextAppWebDomainId: The next **app web domain identifier** that will be used for the next subsite created within the site collection.

2.2.6.7 Sites View

The **Sites View** reflects all rows in the table **AllSites** (section [2.2.6.6](#)) that are not scheduled for deletion (that is, all table rows where Deleted is equal to 0). **Sites View** records information about site collections.

See **AllSites** for the T-SQL syntax description of the structure of this view.

2.2.6.8 UserData View

The **UserData View** reflects all list items in the **AllUserData** table (section [2.2.6.2](#)) that are current versions and not marked as deleted (that is, all table rows where **tp_IsCurrentVersion** is 1, **tp_CalculatedVersion** is 0, and **tp_DeleteTransactionId** is 0x).

See **AllUserData** for the T-SQL syntax description of the structure of this view. Columns defined with the keyword SPARSE do not appear in this view.

2.2.6.9 UserDataVersioned View

The **UserDataVersioned View** reflects all list items in the **AllUserData** table (section [2.2.6.2](#)) that are not deleted (that is, all table rows where **tp_DeleteTransactionId** is 0x).

See **AllUserData** for the T-SQL syntax description of the structure of this view.

2.2.6.10 UserInfo Table

The **UserInfo Table** stores descriptive properties and security information about principals with access to a site collection. The **UserInfo Table** is defined using T-SQL syntax, as follows.

```

TABLE UserInfo (
tp_SiteID                uniqueidentifier NOT NULL,
tp_Id                    int NOT NULL,
tp_DomainGroup           bit NOT NULL,
tp_SystemID              varbinary(512) NOT NULL,
tp_Deleted               int NOT NULL,
tp_SiteAdmin             bit NOT NULL,
tp_IsActive              bit NOT NULL DEFAULT (1),
tp_Login                 nvarchar(255) NOT NULL,
tp_Title                 nvarchar(255) NOT NULL,
tp_Email                 nvarchar(255) NOT NULL,
tp_Notes                 nvarchar(1023) NOT NULL,
tp_Token                 varbinary(max) NULL,
tp_ExternalToken         varbinary(max) NULL,
tp_ExternalTokenLastUpdated datetime NULL,
tp_Locale                int NULL,
tp_CalendarType          smallint NULL,
tp_AdjustHijriDays       smallint NULL,
tp_TimeZone              smallint NULL,
tp_Time24                bit NULL,
tp_AltCalendarType       tinyint NULL,
tp_CalendarViewOptions   tinyint NULL,
tp_WorkDays              smallint NULL,
tp_WorkDayStartHour      smallint NULL,
tp_WorkDayEndHour        smallint NULL,
tp_Mobile                nvarchar(127) NULL,
tp_MUILanguages          varchar(64) NULL,
tp_ContentLanguages      varchar(64) NULL,
tp_Flags                 int NOT NULL DEFAULT (0),
);

```

tp_SiteID: The Site Collection Identifier (section [2.2.1.1.9](#)) of the site collection associated with the principal.

tp_Id: The User Identifier (section [2.2.1.1.13](#)) of the principal, which MUST be unique within both this table and the group identifiers for permission levels. Certain User Identifiers are predefined, such as the system account (1073741823), the site collection owner (1), and the secondary site collection contact (2). User Identifier values of 0 and -1 MUST NOT be used in the table.

tp_DomainGroup: A bit set to 1 if the principal is a domain group; otherwise, 0, specifying that the principal is a user.

tp_SystemID: The **SystemId** of the principal.

tp_Deleted: A value specifying whether the principal is marked as deleted. If **tp_Deleted** is 0, the principal is not deleted. If **tp_Deleted** is not 0, the principal is marked as deleted, and the value is the User Identifier that was associated with this principal. The deleted state can be used for user information, rather than dropping entries from the table, to preserve list item ownership information. A user or domain group with the **tp_Deleted** value set to nonzero can be restored by setting the **tp_Deleted** value to 0 and updating other fields as necessary.

tp_SiteAdmin: A bit set to 1 if the principal is a site collection administrator for the site collection.

tp_IsActive: A bit set to 1 if the principal is an active user in the site collection.

tp_Login: The login name for the principal. This value MUST NOT be empty.

tp_Title: The display name for the principal. This value MUST NOT be empty.

tp_Email: The e-mail address for the principal. This value can be empty.

tp_Notes: A descriptive text about the principal. This value can be empty.

tp_Token: A **WSS User Token** (section [2.2.3.10](#)) value specifying the permission level membership of the principal. This can be NULL, indicating that the principal is not a member of a permission level.

tp_ExternalToken: An **External Group Token** (section [2.2.3.2](#)) value encoding information on external group membership derived from an external authentication role provider. This value can be NULL, indicating that this user has never visited any site in the site collection. If this value is NULL, the value in **tp_ExternalTokenLastUpdated** MUST also be NULL.

tp_ExternalTokenLastUpdated: A datetime containing a time stamp in UTC format specifying the time when the value in **tp_ExternalToken** for the principal was last updated. This can be NULL if the value in **tp_ExternalToken** has never been updated.

tp_Locale: An LCID specifying the preferred locale value to be used when displaying messages in the front-end Web server for the principal. This can be NULL, specifying that the system or site default locale can be used instead.

tp_CalendarType: The **Calendar Type** to be used when processing date values for the principal. This can be NULL, specifying that the site default **Calendar Type** can be used instead.

tp_AdjustHijriDays: If the **tp_CalendarType** value is "6", this specifies the number of days to extend or reduce the current month in Hijri calendars for the principal. Otherwise, this value MUST be NULL and MUST be ignored.

tp_TimeZone: The **Time Zone Identifier** for the time zone to be used when displaying time values for the principal. This can be NULL, specifying that the system or site default time zone can be used instead.

tp_Time24: A bit flag specifying whether a 24-hour time format can be used when displaying time values to the principal. If **tp_Time24** is 1, the 24-hour time format will be used; otherwise, the 12-hour time format will be used. This can be NULL, specifying that the system or site default can be used instead.

tp_AltCalendarType: The **Calendar Type** of an alternate calendar to be used when displaying calendars in views for the principal. This can be NULL, specifying that the **tp_CalendarType** value can be used instead.

tp_CalendarViewOptions: A **Calendar View Options Type** that specifies the calendar options for the principal. This can be NULL, specifying that the site default calendar view options can be used instead.

tp_WorkDays: A set of **Workdays Flags** that specify the weekdays defined as the workweek for the principal. This can be NULL, specifying that the site default **Workdays** value can be used instead.

tp_WorkDayStartHour: The start time of the workday in minutes after midnight for the principal. This can be NULL, specifying that the site default workday start hour can be used instead.

tp_WorkDayEndHour: The end time of the workday in minutes after midnight for the principal. This can be NULL, specifying that the site default workday end hour can be used instead.

tp_Mobile: The mobile phone number of the **security principal**.

tp_MUILanguages: A string that contains the distinct culture(s) for the user's preferred display language(s), separated by semicolon. This string can be NULL.

tp_ContentLanguages: A string that contains the distinct culture(s) for the user's preferred content language(s), separated by semicolon. This string can be NULL.

tp_Flags: A 4-byte integer bit mask determining the user's options. For more details, see [\[MS-WSSFO2\]](#) section 2.2.1.12.

2.2.6.11 WebMembers

The **WebMembers** table stores information used for determining the membership of users in sites. This table is defined using T-SQL syntax, as follows.

```
TABLE WebMembers (
    SiteId                uniqueidentifier NOT NULL,
    WebId                 uniqueidentifier NOT NULL,
    UserId                int NOT NULL
);
```

SiteId: The site collection identifier of the site collection that contains this site.

WebId: The site identifier of the site associated with the user.

UserId: The user identifier of the user associated with the site.

2.2.6.12 Versions

The **Versions Table** stores information used for object versioning during upgrade operations. This Table is defined using T-SQL syntax, as follows.

```
TABLE Versions (
    VersionId            uniqueidentifier NOT NULL,
    Version              nvarchar(64) NOT NULL,
    Id                   int IDENTITY(1,1) NOT NULL,
    UserName             nvarchar(255) NULL,
    TimeStamp            datetime NULL,
    FinalizeTimeStamp    datetime NULL,
    Mode                 int NULL,
    ModeStack            int NULL,
    Updates              int NOT NULL DEFAULT((0)),
    Notes                nvarchar(1024) NULL
);
```

VersionId: A GUID that identifies the version.

Version: The actual version string in the format "<major>.<minor>.<build>.<iteration>" (for example, "3.0.106.0").

Id: An integer value that is an SQL identity column.

UserName: A string containing the user name adding or updating the version.

TimeStamp: A time stamp in UTC format indicating when the version was added or updated.

FinalizeTimeStamp: Unused.

Mode: Unused.

ModeStack: Unused.

Updates: An integer value tracking the number of updates applied to a particular version. This value **MUST** be initialized to 1 when inserted and incremented each time the version is updated.

Notes: A string containing optional notes associated with the version.

2.2.7 XML Structures

No common XML Structures are defined in this protocol.

2.2.7.1 Namespaces

This specification does not define any common XML schema namespaces.

2.2.7.2 Simple Types

2.2.7.2.1 FALSE_Case_Insensitive_Else_Anything

This type is used to specify a **Boolean** value.

```
<xs:simpleType name="FALSE_Case_Insensitive_Else_Anything">
  <xs:restriction base="xs:string">
    <xs:pattern value="[Ff][Aa][Ll][Ss][Ee]|.*" />
  </xs:restriction>
</xs:simpleType>
```

2.2.7.2.2 FieldInternalType

The **FieldInternalType** type is used to specify a field internal type.

Note: In the following XML, the **value** attribute is broken into multiple lines only for readability.

```
<xs:simpleType name="FieldInternalType">
  <xs:restriction base="xs:string">
    <xs:pattern value="[iI][nN][tT][eE][gG][eE][rR]|[tT][eE][xX]
[tT][nN][oO][tT][eE][dD][aA][tT][eE][tT][iI][mM][eE][cC][oO][uU][nN]
[tT][eE][rR]|[cC][hH][oO][iI][cC][eE][lL][oO][oO][kK][uU][pP][bB][oO]
[oO][lL][eE][aA][nN][nN][uU][mM][bB][eE][rR]|[cC][uU][rR][rR][eE][nN]
[cC][yY][uU][rR][lL][cC][oO][mM][pP][uU][tT][eE][dD][tT][hH][rR][eE]
[aA][dD][iI][nN][gG][uU][iI][dD][mM][uU][lL][tT][iI][cC][hH][oO]
[iI][cC][eE][gG][rR][iI][dD][cC][hH][oO][iI][cC][eE][cC][aA][lL][cC]
[uU][lL][aA][tT][eE][dD][fF][iI][lL][eE][aA][tT][tT][aA][cC][hH][mM]
[eE][nN][tT][sS][uU][sS][eE][rR][rR][eE][cC][uU][rR][rR][eE][nN][cC]
[eE][cC][rR][oO][sS][sS][pP][rR][oO][jJ][eE][cC][tT][lL][iI][nN][kK][mM]
[oO][dD][sS][tT][aA][tT][eE][rR][rR][oO][rR][cC][oO][nN][tT][eE]
[nN][tT][oO][yY][pP][eE][iI][dD][pP][aA][gG][eE][sS][eE][pP][aA][rR]
[aA][tT][oO][rR][tT][hH][rR][eE][aA][dD][iI][nN][dD][eE][xX][wW][oO]
[rR][kK][fF][lL][oO][wW][sS][tT][aA][tT][uU][sS][aA][lL][lL][dD][aA]
[yY][eE][vV][eE][nN][tT][wW][oO][rR][kK][fF][lL][oO][wW][eE][vV][eE]
[nN][tT][tT][yY][pP][eE]" />
```

```
</xs:restriction>  
</xs:simpleType>
```

While the **XSD** pattern is normative, the values are:

- Integer
- Text
- Note
- datetime
- Counter
- Choice
- Lookup
- Boolean
- Number
- Currency
- Url
- Computed
- Threading
- GUID
- MultiChoice
- GridChoice
- Calculated
- File
- Attachments
- User
- Recurrence
- CrossProjectLink
- ModStat
- Error
- ContentTypeId
- PageSeparator

- ThreadIndex
- WorkflowStatus
- AllDayEvent
- WorkFlowEventType

2.2.7.2.3 FieldAggregationAttribute

The **FieldAggregationAttribute** type is used to specify how values are promoted from an XML or site template document.

```
<xs:simpleType name="FieldAggregationAttribute">
  <xs:restriction base="xs:string">
    <xs:enumeration value="average" />
    <xs:enumeration value="count" />
    <xs:enumeration value="first" />
    <xs:enumeration value="last" />
    <xs:enumeration value="max" />
    <xs:enumeration value="merge" />
    <xs:enumeration value="min" />
    <xs:enumeration value="plaintext" />
    <xs:enumeration value="signature" />
    <xs:enumeration value="sum" />
  </xs:restriction>
</xs:simpleType>
```

The meanings of the values are specified in the following table. In the table, a matching node means an element or an attribute that matches a specified XPath query. The value of an element node is the concatenation of all character data directly contained by the element.

| Value | Description |
|-----------|--|
| average | The average of the matching nodes, whose values can be interpreted as a floating point numbers. Empty string if no values match. |
| count | Count of the matching nodes. |
| first | The value of the first matching node. |
| last | The value of the last matching node. |
| max | The value of the largest matching node interpreted as a floating point number. |
| merge | The value of the nodes, in order, delimited by a newline character. |
| min | The value of the smallest matching node interpreted as a floating point number. |
| plaintext | If no nodes match, or if the first matching node is not an element, an empty string. Otherwise, renders the first matching node and its child elements with only character data shown. |
| signature | TRUE if the first matching node is an element and has child elements. FALSE if the first matching node is an element with no child elements. Otherwise, an empty string. |
| sum | The sum of the nodes that match and whose values can be interpreted as a floating point |

| Value | Description |
|-------|-------------|
| | numbers. |

2.2.7.2.4 FieldRefType

The **FieldRefType** type is used to specify the type of relationship given by a field reference definition within the field.

```
<xs:simpleType name="FieldRefType">
  <xs:restriction base="xs:string">
    <xs:enumeration value="Recurrence" />
    <xs:enumeration value="EventType" />
    <xs:enumeration value="UID" />
    <xs:enumeration value="RecurrenceId" />
    <xs:enumeration value="EventCancel" />
    <xs:enumeration value="StartDate" />
    <xs:enumeration value="EndDate" />
    <xs:enumeration value="RecurData" />
    <xs:enumeration value="Duration" />
    <xs:enumeration value="TimeZone" />
    <xs:enumeration value="XMLTZone" />
    <xs:enumeration value="CPLink" />
    <xs:enumeration value="LinkURL" />
    <xs:enumeration value="MasterSeriesItemID" />
    <xs:enumeration value="AllDayEvent" />
  </xs:restriction>
</xs:simpleType>
```

2.2.7.2.5 FieldRichTextMode

The **FieldRichTextMode** type is used to specify a formatting mode for a **rich text** field.

```
<xs:simpleType name="FieldRichTextMode">
  <xs:restriction base="xs:string">
    <xs:enumeration value="Compatible"/>
    <xs:enumeration value="FullHtml"/>
    <xs:enumeration value="HtmlAsXml"/>
    <xs:enumeration value="ThemeHtml"/>
  </xs:restriction>
</xs:simpleType>
```

The meanings of the values are specified in the following table.

| Value | Description |
|------------|--|
| Compatible | Specifies support for basic formatting, such as bold formatting. |
| FullHtml | Specifies support for more advanced formatting options, such as pictures, tables, and hyperlinks. |
| HtmlAsXml | Specifies support for HTML that is well-formed XML. |
| ThemeHtml | Specifies support for formatting with in-line style specifications. See [HTML] , section 14.2.2. |

2.2.7.2.6 IMEMode

The **IMEMode** type is used to specify a bias for an **Input Method Editor (IME)**.

```
<xs:simpleType name="IMEMode">
  <xs:restriction base="xs:string">
    <xs:enumeration value="inactive" />
    <xs:enumeration value="auto" />
    <xs:enumeration value="active" />
    <xs:enumeration value="disabled" />
  </xs:restriction>
</xs:simpleType>
```

The reader **MUST** accept any value. The writer **SHOULD** write this attribute as one of the valid values for the **ime-mode** attribute (as described in [\[CSS3UI\]](#)) to be applied to an <input> tag (as specified in [\[HTML\]](#), section 17.4).

2.2.7.2.7 IntPositive

This type is used to specify a positive integer.

```
<xs:simpleType name="IntPositive">
  <xs:restriction base="xs:int">
    <xs:minInclusive value="1" />
  </xs:restriction>
</xs:simpleType>
```

2.2.7.2.8 JoinType

The **JoinType** type specifies how to handle lookup fields for which the target of the lookup does not exist.

```
<xs:simpleType name="JoinType">
  <xs:restriction base="xs:string">
    <xs:enumeration value="INNER" />
    <xs:enumeration value="LEFT OUTER" />
  </xs:restriction>
</xs:simpleType>
```

The meanings of the values are specified in the following table.

| Value | Description |
|------------|---|
| INNER | Items whose target does not exist are omitted. |
| LEFT OUTER | Items whose target does not exist are included. |

2.2.7.2.9 TextDirection

The **TextDirection** type is used to specify the preferred direction of displaying text.

```
<xs:simpleType name="TextDirection">
  <xs:restriction base="xs:string">
```

```

    <xs:enumeration value="ltr" />
    <xs:enumeration value="rtl" />
    <xs:enumeration value="none" />
    <xs:enumeration value="None" />
  </xs:restriction>
</xs:simpleType>

```

The meanings of the values are specified in the following table.

| Value | Description |
|-------|---|
| ltr | Specifies a left-to-right text direction. |
| rtl | Specifies a right-to-left text direction. |
| none | Specifies no hint for a text direction, and that the direction will follow the context of the page. |
| None | Same as none. |

2.2.7.2.10 TRUE_If_Present

This type is used to specify a Boolean value.

```

<xs:simpleType name="TRUE_If_Present">
  <xs:restriction base="xs:string"/>
</xs:simpleType>

```

2.2.7.2.11 TRUEFALSE

This type is used to specify a Boolean value.

```

<xs:simpleType name="TRUEFALSE">
  <xs:restriction base="xs:string">
    <xs:pattern value="[Tt][Rr][Uu][Ee]|[Ff][Aa][Ll][Ss][Ee]"/>
  </xs:restriction>
</xs:simpleType>

```

2.2.7.2.12 TRUE_Case_Sensitive_Else_Anything

This type is used to specify a Boolean value.

```

<xs:simpleType name="TRUE_Case_Sensitive_Else_Anything">
  <xs:restriction base="xs:string">
    <xs:pattern value="TRUE|.*" />
  </xs:restriction>
</xs:simpleType>

```

2.2.7.2.13 UniqueIdentifierWithBracesUppercase

This type is used to specify a GUID.

```

<xs:simpleType name="UniqueIdentifierWithBracesUppercase">

```

```

<xs:restriction base="xs:string">
  <xs:pattern value="\{?[0-9A-F]{8}\-?[0-9A-F]{4}\-?[0-9A-F]{4}\-?[0-9A-F]{4}\-?[0-9A-F]{12}\}?" />
</xs:restriction>
</xs:simpleType>

```

2.2.7.2.14 UniqueIdentifierWithOrWithoutBraces

This type is used to specify a GUID.

```

<xs:simpleType name="UniqueIdentifierWithOrWithoutBraces">
  <xs:restriction base="xs:string">
    <xs:pattern value="\{?[0-9a-fA-F]{8}\-[0-9a-fA-F]{4}\-[0-9a-fA-F]{4}\-[0-9a-fA-F]{4}\-[0-9a-fA-F]{12}\}?" />
  </xs:restriction>
</xs:simpleType>

```

2.2.7.2.15 RelationshipDeleteBehaviorAttribute

The **RelationshipDeleteBehaviorAttribute** describes the relationship between a list item and the target list item of a **Lookup** field.

```

<xs:simpleType name="RelationshipDeleteBehaviorAttribute">
  <xs:restriction base="xs:string">
    <xs:enumeration value="Cascade" />
    <xs:enumeration value="Restrict" />
    <xs:enumeration value="None" />
  </xs:restriction>
</xs:simpleType>

```

The meanings of the values are specified in the following table.

| Value | Description |
|----------|---|
| Cascade | Specifies that when a list item in the target list is deleted, all related items in the list that contains the Lookup field are also deleted. |
| Restrict | Specifies that deleting a list item in the target list is prevented if there are any related items in the list that contains the Lookup field. |
| None | Specifies no restrictions. |

2.2.7.3 Complex Types

2.2.7.3.1 CHOICEDEFINITION

The **CHOICEDEFINITION** type contains a choice for a **Choice** or **MultiChoice** field.

2.2.7.3.1.1 Schema

```

<xs:complexType name="CHOICEDEFINITION" mixed="true">
  <xs:attribute name="JumpTo" type="xs:string" />

```

```
</xs:complexType>
```

2.2.7.3.1.2 Attributes

JumpTo: Specifies the **Name** of the next field in a survey list to display when this choice is selected.

2.2.7.3.1.3 Child Elements

<Content>: Specifies a value for a choice in a **Choice** or **MultiChoice** field.

2.2.7.3.2 CHOICEDEFINITIONS

The **CHOICEDEFINITIONS** type contains a collection of choices for a **Choice** or **MultiChoice** field.

2.2.7.3.2.1 Schema

```
<xs:complexType name="CHOICEDEFINITIONS">
  <xs:sequence>
    <xs:element name="CHOICE" type="CHOICEDEFINITION" minOccurs="0" maxOccurs="unbounded"
  />
  </xs:sequence>
</xs:complexType>
```

2.2.7.3.2.2 Attributes

None.

2.2.7.3.2.3 Child Elements

CHOICE: Specifies a choice in a **Choice** or **MultiChoice** field.

2.2.7.3.3 FieldDefinition

A field definition describes the structure and format of a field that is used within a list or content type.

2.2.7.3.3.1 Schema

```
<xs:complexType name="FieldDefinition" mixed="true">
  <xs:all>
    <xs:element name="CHOICES" type="CHOICEDEFINITIONS" minOccurs="0" maxOccurs="1" />
    <xs:element name="Customization" minOccurs="0" maxOccurs="1">
      <xs:complexType>
        <xs:sequence>
          <xs:any minOccurs="1" maxOccurs="1" namespace="##any"
processContents="skip" />
        </xs:sequence>
      </xs:complexType>
    </xs:element>
    <xs:element name="Default" type="xs:string" minOccurs="0" maxOccurs="1" />
    <xs:element name="DefaultFormula" type="xs:string" minOccurs="0" maxOccurs="1" />
    <xs:element name="DisplayBidiPattern" minOccurs="0" maxOccurs="1">
      <xs:complexType>
```

```

        <xs:sequence>
          <xs:any minOccurs="0" maxOccurs="unbounded" namespace="##any"
processContents="skip" />
        </xs:sequence>
        <xs:anyAttribute processContents="skip" />
      </xs:complexType>
    </xs:element>
    <xs:element name="DisplayPattern" minOccurs="0" maxOccurs="1">
      <xs:complexType>
        <xs:sequence>
          <xs:any minOccurs="0" maxOccurs="unbounded" namespace="##any"
processContents="skip" />
        </xs:sequence>
        <xs:anyAttribute processContents="skip" />
      </xs:complexType>
    </xs:element>
    <xs:element name="FieldRefs" minOccurs="0" maxOccurs="1">
      <xs:complexType mixed="true">
        <xs:sequence>
          <xs:element name="FieldRef" type="FieldRefDefinitionField" minOccurs="0"
maxOccurs="unbounded" />
        </xs:sequence>
      </xs:complexType>
    </xs:element>
    <xs:element name="Formula" type="xs:string" minOccurs="0" maxOccurs="1" />
    <xs:element name="FormulaDisplayNames" type="xs:string" minOccurs="0" maxOccurs="1" />
    <xs:element name="MAPPINGS" type="MAPPINGDEFINITIONS" minOccurs="0" maxOccurs="1" />
    <xs:element name="ParserRefs" type="FieldParserRefs" minOccurs="0" maxOccurs="1" />
    <xs:element name="Validation" minOccurs="0" maxOccurs="1">
      <xs:complexType>
        <xs:sequence>
          <xs:any minOccurs="0" maxOccurs="unbounded" namespace="##any"
processContents="skip" />
        </xs:sequence>
        <xs:anyAttribute processContents="skip" />
      </xs:complexType>
    </xs:element>
  </xs:all>
  <xs:attribute name="Aggregation" type="FieldAggregationAttribute" default="first"/>
  <xs:attribute name="aggregation" type="xs:string" />
  <xs:attribute name="AllowDeletion" type="TRUEFALSE" default="TRUE" />
  <xs:attribute name="AllowHyperlink" type="TRUEFALSE" default="FALSE" />
  <xs:attribute name="AllowMultiVote" type="TRUEFALSE" default="FALSE" />
  <xs:attribute name="AppendOnly" type="TRUEFALSE" default="FALSE" />
  <xs:attribute name="AuthoringInfo" type="xs:string" default="" />
  <xs:attribute name="BaseRenderingType" type="FieldInternalType" />
  <xs:attribute name="BaseType" type="FieldInternalType" default="Text" />
  <xs:attribute name="Calculated" type="xs:string" />
  <xs:attribute name="CalType" type="xs:int" />
  <xs:attribute name="CalendarType" type="xs:int" />
  <xs:attribute name="CAMLRendering" type="TRUEFALSE" default="FALSE" />
  <xs:attribute name="CanToggleHidden" type="TRUEFALSE" default="FALSE" />
  <xs:attribute name="CountRelated" type="TRUE_If_Present" default="FALSE" />
  <xs:attribute name="ClassInfo" type="xs:string" default="" />
  <xs:attribute name="ColName" type="xs:string" />
  <xs:attribute name="ColName2" type="xs:string" />
  <xs:attribute name="Commas" type="TRUEFALSE" />
  <xs:attribute name="Customization" type="xs:string" />
  <xs:attribute name="Decimals" type="xs:int" default="-1"/>

```

```

<xs:attribute name="DefaultListField" type="TRUEFALSE" default="FALSE" />
<xs:attribute name="DefaultURLDesc" type="xs:string" />
<xs:attribute name="Description" type="xs:string" />
<xs:attribute name="Direction" type="TextDirection" default="none" />
<xs:attribute name="Dir" type="xs:string" />
<xs:attribute name="DisplaceOnUpgrade" type="TRUEFALSE" default="FALSE" />
<xs:attribute name="DisplayImage" type="xs:string" />
<xs:attribute name="DisplayName" type="xs:string" />
<xs:attribute name="DisplayNameSrcField" type="xs:string" />
<xs:attribute name="DisplaySize" type="xs:int" />
<xs:attribute name="Div" type="xs:string" default="1.0" />
<xs:attribute name="EnableLookup" type="TRUEFALSE" default="FALSE" />
<xs:attribute name="EnforceUniqueValues" type="TRUEFALSE" default="FALSE" />
<xs:attribute name="ExceptionImage" type="xs:string" />
<xs:attribute name="FieldRef" type="xs:string" />
<xs:attribute name="FillInChoice" type="TRUEFALSE" default="FALSE" />
<xs:attribute name="Filterable" type="TRUEFALSE" default="TRUE" />
<xs:attribute name="FilterableNoRecurrence" type="TRUEFALSE" default="FALSE" />
<xs:attribute name="ForcedDisplay" type="xs:string" />
<xs:attribute name="ForcePromoteDemote" type="TRUE_If_Present" />
<xs:attribute name="Format" type="xs:string" />
<xs:attribute name="FromBaseType" type="TRUEFALSE" default="FALSE" />
<xs:attribute name="GridEndNum" type="xs:int" />
<xs:attribute name="GridNATxt" type="xs:string" default="" />
<xs:attribute name="GridStartNum" type="IntPositive" />
<xs:attribute name="GridTxtRng1" type="xs:string" default="" />
<xs:attribute name="GridTxtRng2" type="xs:string" default="" />
<xs:attribute name="GridTxtRng3" type="xs:string" default="" />
<xs:attribute name="Group" type="xs:string" />
<xs:attribute name="HeaderImage" type="xs:string" />
<xs:attribute name="Height" type="xs:int" />
<xs:attribute name="Hidden" type="TRUEFALSE" default="FALSE" />
<xs:attribute name="ID" type="UniqueIdentifierWithOrWithoutBraces" />
<xs:attribute name="Id" type="xs:string" />
<xs:attribute name="IMEMode" type="IMEMode" />
<xs:attribute name="Indexed" type="TRUEFALSE" default="FALSE" />
<xs:attribute name="ImnHeader" type="xs:string" />
<xs:attribute name="IsolateStyles" type="TRUEFALSE" default="FALSE" />
<xs:attribute name="IsRelationship" type="TRUEFALSE" default="FALSE" />
<xs:attribute name="JoinColName" type="xs:string" default="tp_ID" />
<xs:attribute name="JoinRowOrdinal" type="xs:int" fixed="0" />
<xs:attribute name="JoinType" type="JoinType" default="LEFT OUTER" />
<xs:attribute name="JumpTo" type="xs:string" />
<xs:attribute name="JumpToFillInChoice" type="xs:string" />
<xs:attribute name="JumpToNo" type="xs:string" />
<xs:attribute name="JumpToYes" type="xs:string" />
<xs:attribute name="LCID" type="xs:int" />
<xs:attribute name="LinkToItem" type="TRUE_Case_Sensitive_Else_Anything" />
<xs:attribute name="LinkToItemAllowed" type="xs:string" />
<xs:attribute name="List" type="xs:string" />
<xs:attribute name="ListItemMenu" type="TRUE_Case_Sensitive_Else_Anything" />
<xs:attribute name="ListItemMenuAllowed" type="xs:string" />
<xs:attribute name="Max" type="xs:float" />
<xs:attribute name="MaxLength" type="xs:int" />
<xs:attribute name="maxLength" type="xs:string" />
<xs:attribute name="Min" type="xs:string" />
<xs:attribute name="Mult" type="xs:string" />
<xs:attribute name="Name" type="xs:string" use="required" />
<xs:attribute name="NegativeFormat" type="xs:string" />

```

```

<xs:attribute name="node" type="xs:string" />
<xs:attribute name="Node" type="xs:string" />
<xs:attribute name="NoEditFormBreak" type="TRUEFALSE" default="FALSE" />
<xs:attribute name="NumLines" type="xs:string" default="6" />
<xs:attribute name="Percentage" type="TRUEFALSE" default="FALSE" />
<xs:attribute name="PIAttribute" type="xs:string" />
<xs:attribute name="PITarget" type="xs:string" />
<xs:attribute name="PrependId" type="TRUEFALSE" default="FALSE" />
<xs:attribute name="Presence" type="TRUEFALSE" default="FALSE" />
<xs:attribute name="PreviousName" type="xs:string" />
<xs:attribute name="PrimaryKey" type="TRUEFALSE" />
<xs:attribute name="PrimaryPIAttribute" type="xs:string" />
<xs:attribute name="PrimaryPITarget" type="xs:string" />
<xs:attribute name="ReadOnly" type="TRUEFALSE" default="FALSE" />
<xs:attribute name="ReadOnlyEnforced" type="TRUEFALSE" default="FALSE" />
<xs:attribute name="RelationshipDeleteBehavior" type="RelationshipDeleteBehaviorAttribute"
default="None" />
<xs:attribute name="RenderXMLUsingPattern" type="TRUEFALSE" default="FALSE" />
<xs:attribute name="Required" type="TRUEFALSE" default="FALSE" />
<xs:attribute name="RestrictedMode" type="TRUEFALSE" default="TRUE" />
<xs:attribute name="ResultType" type="FieldInternalType" />
<xs:attribute name="ResyncOnChange" type="TRUEFALSE" default="FALSE" />
<xs:attribute name="RichText" type="TRUEFALSE" default="FALSE" />
<xs:attribute name="RichTextMode" type="FieldRichTextMode" default="Compatible" />
<xs:attribute name="RowOrdinal" type="xs:int" default="0" />
<xs:attribute name="RowOrdinal2" type="xs:int" default="0" />
<xs:attribute name="Sealed" type="TRUEFALSE" default="FALSE" />
<xs:attribute name="SeparateLine" type="TRUEFALSE" default="FALSE" />
<xs:attribute name="SetAs" type="xs:string" />
<xs:attribute name="ShowAddressBookButton" type="TRUEFALSE" default="FALSE" />
<xs:attribute name="ShowField" type="xs:string" />
<xs:attribute name="ShowInDisplayForm" type="TRUEFALSE" />
<xs:attribute name="ShowInEditForm" type="TRUEFALSE" default="TRUE" />
<xs:attribute name="ShowInFileDialog" type="TRUEFALSE" />
<xs:attribute name="ShowInFileDialog" type="TRUEFALSE" />
<xs:attribute name="ShowInListSettings" type="TRUEFALSE" />
<xs:attribute name="ShowInNewForm" type="TRUEFALSE" default="TRUE" />
<xs:attribute name="ShowInVersionHistory" type="TRUEFALSE" />
<xs:attribute name="ShowInViewForms" type="TRUEFALSE" />
<xs:attribute name="Sortable" type="TRUEFALSE" />
<xs:attribute name="SourceID" type="xs:string" />
<xs:attribute name="StaticName" type="xs:string" />
<xs:attribute name="StorageTZ" type="xs:string" />
<xs:attribute name="StripWS" type="xs:string" />
<xs:attribute name="SuppressNameDisplay" type="TRUEFALSE" />
<xs:attribute name="TextOnly" type="TRUEFALSE" />
<xs:attribute name="Title" type="xs:string" />
<xs:attribute name="TitleField" type="TRUEFALSE" default="FALSE" />
<xs:attribute name="Type" type="xs:string" use="required" />
<xs:attribute name="UniqueId" type="xs:string" />
<xs:attribute name="UnlimitedLengthInDocumentLibrary" type="TRUEFALSE" />
<xs:attribute name="URLEncode" type="TRUEFALSE" />
<xs:attribute name="URLEncodeAsURL" type="TRUEFALSE" />
<xs:attribute name="UserSelectionMode" type="xs:string" />
<xs:attribute name="UserSelectionScope" type="xs:int" />
<xs:attribute name="Version" type="xs:int" default="0" />
<xs:attribute name="Viewable" type="FALSE_Case_Insensitive_Else_Anything" />
<xs:attribute name="WebId" type="UniqueIdentifierWithoutBraces" />
<xs:attribute name="Width" type="xs:int" />

```



```

<xs:attribute name="WikiLinking" type="TRUEFALSE" default="FALSE" />
<xs:attribute name="WorkflowStatusURL" type="xs:string" use="optional" />
<xs:attribute name="XName" type="xs:string" />
<xs:anyAttribute namespace="##other" processContents="lax" />
</xs:complexType>

```

2.2.7.3.3.2 Attributes

Aggregation: For fields with the **Node** or **node** attribute, a reader MUST use this attribute to control promotion from XML or site template files.

For other fields, a reader MUST ignore this attribute.

aggregation: For fields whose **Type** attribute maps to the **Note** field internal type, the reader can permit a filtering user interface if this attribute contains the value merge (with case-insensitive comparison).[<4>](#) Otherwise a reader MUST ignore this attribute.

A writer SHOULD NOT include this attribute.

AllowDeletion: If this attribute is FALSE, then this is used to specify that a server MUST NOT permit the field to be removed from the schema of a list.

AllowHyperlink: For fields whose **Type** maps to the **Note** field internal type, and for which **RichText** is TRUE and **RichTextMode** is Compatible, a reader can use this attribute to determine if the editing UI allows insertion of hyperlinks. If this attribute is TRUE, a server or client presenting an editing user interface for this field MUST include the insert hyperlink command. Otherwise, the editing user interface MUST NOT include the insert hyperlink command.

AllowMultiVote: The reader MUST ignore this attribute.

AppendOnly: If TRUE, for fields whose **Type** maps to the **Note** field internal type, a client or server which presents a way of editing the value for this field MUST do so in a way that ensures preservation of old data in the field.

AuthoringInfo: Text describing the field to schema authors. A client or server presenting a schema-editing UI can display the text in this attribute.

BaseRenderingType: Field internal type that the server uses to render a field. If not present, the **Type** attribute does not map to an internal type in a way suitable for rendering.

The server MUST derive the value of this attribute from the **Type** attribute, overriding the client-specified value.

BaseType: Allows a schema author to override the internal storage format for choice fields. A reader MUST ignore this attribute unless the field's internal type is Choice, MultiChoice, or GridChoice. A writer MUST NOT set this attribute's value to Choice, MultiChoice, or GridChoice.

CalType: Associates a calendar type with a field. A reader SHOULD take this value into consideration when rendering the field or performing date calculations on it. If this attribute is not present, a reader MUST use the **CalendarType** attribute. If that is also not present, it SHOULD fall back to the user's preference, and if that is not specified, to the calendar type for the site.

CalendarType: This is equivalent to **CalType**. A reader MUST use the value of **CalType** if present, but if that attribute is not present, it MUST use this attribute for the same purpose. A writer SHOULD omit this attribute, using **CalType** instead where it is needed.

Calculated: The reader MUST ignore this attribute.

CAMLRendering: If TRUE, a field MUST be rendered using its **DisplayPattern** child element in a **list view**.

CanToggleHidden: If TRUE, a server MUST permit the user to change the value of the **Hidden** attribute. Otherwise, a server MUST prevent the **Hidden** attribute from changing.

CountRelated: If TRUE, the internal type of the field MUST be **Lookup**, the **List** and **FieldRef** attributes of the field MUST refer to a field of internal type **Lookup**, and for the referred field, its **List** attribute MUST refer to the list of which the source field is a member. A writer MUST NOT include this attribute if the **Mult** attribute is present. A reader MUST ignore the attribute if the field internal type of the field is not **Lookup**.

ClassInfo: A writer SHOULD use values **Menu** or **Icon**, or it SHOULD omit the attribute. When rendering the value of the field in a view, a server SHOULD use this to format the field for a menu or an icon. The server MUST ignore values other than **Menu** or **Icon** and MUST fall back to the default behavior for other values.

ColName: A server SHOULD use this attribute to describe the physical storage location for the field. A client MUST ignore this attribute and a server MUST pick its own value for this attribute when accepting CAML from a client.

ColName2: This has the same restrictions and semantics as the **ColName** attribute except it describes a secondary physical storage location.

Commas: A writer SHOULD NOT use this attribute; a reader MUST ignore this attribute.

Customization: A writer SHOULD NOT use this attribute; a reader MUST ignore this attribute.

Decimals: Number of digits to render in the fractional part of a number. A writer SHOULD only use this attribute on fields whose field internal type is **Number** or **Calculated**. The reader MUST ignore this attribute on fields with other internal types. A writer SHOULD omit this attribute rather than write the default value of "-1".

When rendering a numeric field, a server MUST use this attribute to determine the number of decimal places to render. For the special value of -1, trailing zeros MUST be omitted.

DefaultListField: A server or client can determine whether to request field values for a document or list item after a user action such as uploading a new document when editable fields are present on the list. When this attribute is set to TRUE, the server or client can ignore the presence of this field for the purposes of that determination.

DefaultURLDesc: For a field whose field internal type is **URL**, the value to use for the description part when the user does not provide a description. The default is to use the **URL** part of the field. If the field's internal type is not **URL**, a reader MUST ignore this attribute.

Description: Textual description of the field to be displayed in the user interface for schema authoring.

Direction: Specifies that HTML field rendering will be done in a left-to-right, right-to-left, or in the ambient context of the surrounding page.

Dir: A writer SHOULD NOT use this attribute; a reader MUST ignore this attribute.

DisplaceOnUpgrade: When TRUE, indicates that a server depends on the name of a field. The client MUST NOT set this attribute.

DisplayImage: When specified, this attribute supplies the URL, relative to the server's `/_layouts/images` folder, to render when displaying the field. A reader MUST ignore this attribute except for **CrossProjectLink** fields and **Recurrence** fields.

If not specified, a blank placeholder image is used instead.

DisplayName: Text to display in the user interface when referring to the field.

DisplayNameSrcField: When present, specifies the name of another field on the list to which the **DisplayName** of the current field is synchronized.

DisplaySize: Number of columns to offer when displaying the field.

Div: In fields whose field internal type is **Integer**, **Number**, or **Calculated**, a reader MUST interpret this as a floating point number by which the value is divided at render time.

In fields of other internal types, a reader MUST ignore this attribute and a writer MUST NOT include this attribute.

EnableLookup: Specifies whether the user interface for creating a **Lookup** field lists a **Computed** field as a possible target for the lookup. Unless the target field type is **Computed**, a writer SHOULD NOT include this attribute and a reader MUST ignore it.

EnforceUniqueValues: If this attribute is TRUE, then the server MUST NOT permit any list item to have the same value for the field as any other list item in the list, unless the value of the field is NULL.

ExceptionImage: Specifies an image to display in place of **DisplayImage** for recurrence fields for items that are exceptions to the recurrence. A writer MUST include this attribute for recurrence fields if **DisplayImage** is also included and MUST NOT include it otherwise.

FieldRef: When present on a **Lookup** field, specifies the **Name** of another field on the list from which to obtain the local value for the lookup. **Lookup** fields for which this attribute is not specified supply their own storage for the local value.

FillInChoice: Whether a form (2) generated to let the user edit a **Choice** field or **MultiChoice** field allows values other than those listed in the **CHOICES** child element.

A reader MUST ignore this attribute except for **Choice** fields and **MultiChoice** fields.

Filterable: Whether items can be omitted or included from the results of a query based on the value of the field. True if the field can be filtered; false otherwise.

FilterableNoRecurrence: When TRUE, and the **Filterable** attribute is FALSE, specifies that items can be included or omitted from the results of a query in views that do not expand recurring events (2).

ForcedDisplay: If present, specifies a value for the field to display in place of the field's real value.

Format: Specifies how to render the field. The interpretation of this attribute and the range of legal values depend on the value of the **Type** attribute, as follows:

- For a datetime field, the value MUST be **datetime**, **DateOnly**, **TimeOnly**, **ISO8601**, **ISO8601Basic**, **ISO8601Gregorian**, or not present. A reader MUST interpret a missing attribute to mean **datetime**.
- For a **Choice** field, the value MUST be **DropDown**, **RadioButtons**, **Checkbox**, or not present. A reader MUST interpret a missing attribute to mean **DropDown**.

- For a **CrossProjectLink** field, the value MUST be **EventList** or not present.
- For URL fields, the value MUST be **Image**, **Hyperlink**, or not present. A reader MUST interpret a missing attribute as **Hyperlink**.
- For a Boolean field, the value MUST be **CheckboxIcons**, **CheckboxIconsWithHeaderIcon**, or not present.
- A reader MUST ignore this attribute for other field types.

ForcePromoteDemote: Specifies that the field SHOULD participate in property promotion and demotion.

FromBaseType: Indicates that the field was inherited from the list's base type. If TRUE, a server prevents the field from being deleted or having its type changed.

GridEndNum: Specifies the largest choice possible in a **GridChoice** field. A writer MUST include this attribute for **GridChoice** fields. A reader MUST ignore this attribute for other field types.

GridNATxt: Textual value to render for the choice that indicates "not applicable" in a **GridChoice** field. A reader MUST ignore this attribute for fields of other types.

GridStartNum: Specifies the smallest choice possible in a **GridChoice** field. A writer MUST include this attribute for **GridChoice** fields. A reader MUST ignore this attribute for fields of other types. A writer SHOULD set the value of this attribute to 1.

GridTxtRng1: Textual value to render for the choice that indicates the value corresponding to that specified by the **GridStartNum** attribute in a **GridChoice** field. A reader MUST ignore this attribute for other field types.

GridTxtRng2: Textual value to render for the choice that indicates the middle value in a **GridChoice** field. A reader MUST ignore this attribute for other field types.

GridTxtRng3: Textual value to render for the choice that indicates the value corresponding to that specified by the **GridEndNum** attribute in a **GridChoice** field. A reader MUST ignore this attribute for fields of other types.

Group: Name of the field that is used for grouping purposes. A reader MUST take a localized version of "Custom Columns" as the default value for this attribute.

HeaderImage: Specifies a URL, relative to the `/_layouts/images` folder on the server, to render in place of the field's **DisplayName** in views and forms (2).

Height: Height in pixels to render an image for a URL field whose **Format** attribute is equal to Image. If not present, specifies that the target image does not need to be scaled.

A reader MUST ignore this attribute except for URL fields where the **Format** attribute specifies Image and the **Width** attribute is present.

Hidden: Specifies whether to render a field in views or forms (2).

ID: GUID for the field.

Id: A writer SHOULD NOT include this attribute. A reader MUST ignore this attribute.

IMEMode: If specified, indicates a value for the **ime-mode** attribute to be applied to an `<input>` tag when reading the field.

Indexed: Specifies that a server can optimize for queries that filter on this field.

ImnHeader: This attribute is a marker. A reader MUST only check for the existence of the attribute. A writer MUST either not include the attribute or set its value to TRUE.

IsolateStyles: For a **Text** field whose **RichText** attribute is TRUE and whose **RichTextMode** attribute is set to FullHtml, this attribute specifies that a server will rewrite the HTML of the field to ensure it will not interfere with the rendering of the surrounding page.

A reader MUST ignore this attribute in other circumstances.

IsRelationship: Specifies whether the **Lookup** field is a relationship lookup field.

A reader MUST ignore this attribute if the field is not a **Lookup** field.

JoinColName: Specifies the physical storage location in the list referred to by the **List** attribute to compare with the local value of a **Lookup** field.

JoinRowOrdinal: A writer SHOULD NOT include this attribute. <5>

JoinType: Specifies how to treat items that have no corresponding matching item in the list indicated by the **List** attribute.

A reader MUST ignore this attribute except for **Lookup** fields.

JumpTo: Specifies the **Name** of the next field in a survey list when the field has a specified value.

A reader MUST ignore this attribute for Boolean fields.

JumpToFillinChoice: Specifies the **Name** of the next field in a survey list when a value other than those listed in the **CHOICES** child element is selected.

A reader MUST ignore this attribute except for **Choice** fields and **MultiChoice** fields for which the **FillInChoice** attribute is TRUE.

JumpToNo: Specifies the **Name** of the next field in a survey list for a Boolean field for which is false.

JumpToYes: Specifies the **Name** of the next field in a survey list for a Boolean field for which is true.

LCID: LCID used to render **Number** fields, **Currency** fields, and **datetime** fields. When not present, specifies that the default LCID for the user is to be used. A reader MUST ignore this attribute for other types of fields.

LinkToItem: Specifies whether the field value is rendered as a link to the list item.

LinkToItemAllowed: Specifies the allowed state of the **LinkToItem** attribute. The allowed values are **Prohibited**, **Required** and **Allowed**. Value **Allowed** means the link can be optionally shown, **Required** means the link MUST be shown, **Prohibited** means the link can't be shown.

List: Specifies the foreign list for a **Lookup** field.

A writer MUST include this attribute for **Lookup** fields. A reader MUST ignore this attribute for other kinds of fields.

ListItemMenu: Specifies whether the field value is rendered with a drop-down option menu.

ListItemMenuAllowed: Specifies the allowed state of the **ListItemMenu** attribute. The allowed values are **Prohibited**, **Required** and **Allowed**. Value **Allowed** means the menu can be optionally shown, **Required** means the menu MUST be shown, **Prohibited** means the menu can't be shown.

Max: Specifies the maximum value for a **Number** field. A reader MUST ignore this attribute for other kinds of fields.

MaxLength: Specifies the maximum number of characters allowed in a **Text** field.

maxLength: The reader MUST ignore this attribute.

Min: Specifies the minimum value for a **Number** field. A reader MUST ignore this attribute for other kinds of fields.

Mult: In fields whose field internal type is **Integer**, **Number**, or **Calculated**, a reader MUST interpret this as a floating point number by which the value is multiplied at render time. In this context, a reader MUST interpret the default to be 1.0.

In the context of a **Lookup** field, a reader MUST interpret the presence of this attribute as an indication that the field is a multi-value lookup, and the absence of which as an indication that the field is a single-value lookup. In this context, a writer MUST either omit the attribute or set the value to TRUE.

In other contexts, a reader MUST ignore the attribute and the writer SHOULD NOT include the attribute.

Name: String that identifies the field within its list.

NegativeFormat: A writer SHOULD NOT include this attribute. [<6>](#) A reader MUST ignore this attribute.

node: A writer SHOULD use the **Node** attribute rather than this attribute. A reader MUST ignore this attribute when the **Node** attribute is present. Otherwise, a reader MUST use this attribute for the same purpose as it would use the **Node** attribute.

Node: When present, specifies an **XPath** to be used to read or write the value of the field into an XML document.

NoEditFormBreak: For fields where **RichText** is TRUE or where the **Type** is **Choice** or **MultiChoice**, a reader MUST ignore this attribute. For other fields, if true, this attribute specifies that the following field will be rendered on the same line as this field.

NumLines: Number of lines to render when accepting input for a **Note** field. A reader MUST ignore this attribute for other fields.

Percentage: When specified on a **Number** field or a **Calculated** field that evaluates to a number, specifies that the field is rendered as a percentage (100 times its value and with a trailing "%" character).

A reader MUST ignore this attribute for other fields.

PIAttribute: A reader MUST ignore this attribute if either the **Node** or **node** attribute is present, or if both the **PrimaryPIAttribute** and **PrimaryPITarget** attributes are present, or if the **PITarget** attribute is not present.

Otherwise, the reader MUST treat this attribute as it would the **PrimaryPIAttribute** attribute.

PITarget: A reader MUST ignore this attribute if either the **Node** or **node** attribute is present, if both the **PrimaryPIAttribute** and **PrimaryPITarget** attributes are present, or if the **PIAttribute** attribute is not present.

Otherwise, the reader MUST treat this attribute as it would the **PrimaryPITarget** attribute.

PrependId: Whether the edit form for a **Lookup** field for which the **Multi** attribute is TRUE will present choices sorted by **ID** rather than by **ShowField**.

A reader MUST ignore this attribute in other circumstances.

Presence: Whether a **User** field will be decorated with instant messaging presence information.

A reader MUST ignore this attribute for fields that are not user fields.

PreviousName: Indicates the value of the **Name** attribute of the field in an earlier revision of the containing list's schema.

PrimaryKey: A reader MUST ignore this attribute.

PrimaryPIAttribute: When present, specifies an attribute for an XML processing instruction to be used to read or write the value of the field into an XML document.

PrimaryPITarget: When present, specifies an XML processing instruction to be used to read or write the value of the field into an XML document.

ReadOnly: Whether the user is allowed to change the field through the user interface. If TRUE, only programmatic changes are allowed.

ReadOnlyEnforced: Whether the user is allowed to change the field by any means. If TRUE, the field can only be changed by the system.

RelationshipDeleteBehavior: Describes the relationship, if any, between an item in the list and an item that is the target of a **Lookup** field.

A reader MUST ignore this attribute when the field is not a **Lookup** field.

RenderXMLUsingPattern: Whether a **Computed** field is rendered using its **DisplayPattern** child element even when rendering for the object model or SOAP interfaces.

A reader MUST ignore this attribute except for **Computed** fields.

Required: Whether forms (2) presented to accept data for the list item permits blank values for the field.

RestrictedMode: For **Notes** fields for which the **RichText** attribute is TRUE, specifies whether the field permits cut, copy, paste, and insert image commands.

For other kinds of fields, the reader MUST ignore this attribute.

ResultType: If the **Type** attribute specifies that the internal type of the field is **Calculated**, a reader SHOULD use this attribute as in place of the internal type of the field to render results.

A reader MUST ignore this attribute if the internal type of the field is not **Calculated**.

ResyncOnChange: Whether the field's value changes value on form (2) submission.

RichText: Whether a **Note** field contains formatted text; the exact text formatting is subject to the value of the **RichTextMode** attribute.

A reader **MUST** ignore this attribute except for **Note** fields.

RichTextMode: Specifies the serialization of formatted text.

RowOrdinal: The comments for the **ColName** attribute apply to this attribute as well.

RowOrdinal2: The comments for the **ColName** attribute apply to this attribute as well.

Sealed: Specifies how the server allows the field to be changed. If **TRUE**, the server **MUST** prevent changes to the field except for the **DisplayName**, **Description**, **Hidden**, and **Indexed** attributes and the **ParserRefs** child element.

SeparateLine: Determines whether or not the field is displayed on a different row for views that support this feature.

SetAs: A writer **SHOULD NOT** include this attribute. A reader **MUST** ignore this attribute.

ShowAddressBookButton: Determines whether or not a field's edit control includes a facility for entering users from an address book. A reader **MUST** ignore this attribute except when rendering the field in the context of a form (2) that supports this functionality.

ShowField: Specifies the field in the foreign list that supplies the value of a **Lookup** field. A reader **MUST** ignore this attribute unless the field is a **Lookup** field.

If the **Type** attribute is **User**, then the default value for this attribute is **InmName**. If the **Type** is **WorkflowStatus**, the default value for this attribute is **Status1**. Otherwise, the default value is **Title**.

ShowInDisplayForm: Determines whether or not the field is shown or hidden in a form (2) designed to show the item in a read-only fashion. If **TRUE**, then the field will be shown in the form (2) for the item. If **FALSE**, then the field will not be shown in the form (2). If not specified, an implementation-specific algorithm is used to determine if the field will be shown.

ShowInEditForm: When **FALSE**, indicates that the field is not included in the form (2) that is used to modify an item. When **TRUE**, indicates that the field's inclusion in such a form (2) depends on implementation.

ShowInFileDialog: The reader **MUST** ignore this attribute.

ShowInFileDlg: Similar to **ShowInEditForm** except that it applies to a form (2) designed to collect information about a document from within the context of an application.

ShowInEditDlg: Similar to **ShowInEditForm** except that it applies to a form (2) designed to collect information about an item that is being modified.

ShowInListSettings: Similar to **ShowInEditForm** except that it applies to the field's inclusion in the user interface that is presented to list schema editors.

ShowInNewForm: Similar to **ShowInEditForm** except that it applies to the field's inclusion in a form (2) designed to collect information about an item that is being created.

ShowInVersionHistory: Similar to **ShowInEditForm** except that it applies to the field's inclusion in a form (2) designed to display a read-only rendition of a historical version of an item.

ShowInViewForms: Similar to **ShowInEditForm** except that it applies to the field's inclusion in the user interface that is presented to view authors.

Sortable: When FALSE, specifies that query results are not allowed to be ordered with respect to this field.

SourceID: URI suitable for use in an **XML namespace** in cases where the list schema is transformed to an XSD.

StaticName: Local part of an XML element name that is unique within the namespace given by the **SourceID** attribute.

StorageTZ: For datetime fields, specifies the time zone in which the field is stored. If TRUE, then UTC is indicated; otherwise, the site's local time zone is indicated.

The reader MUST ignore this attribute unless the field's type is datetime.

StripWS: The reader MUST ignore this attribute.

SuppressNameDisplay: When specified on a **User** field, the user's name is not displayed but all other rendering information is.

TextOnly: The reader MUST ignore this attribute.

Title: When present on a **CrossProjectLink** fields whose **DisplayImage** attribute is set and whose **Format** attribute specifies EventList, this attribute specifies a textual alternative to the image. When not present but the other conditions are specified, the reader MUST infer a default value from the **DisplayName** attribute. When these conditions are not met, the reader MUST ignore the attribute.

TitleField: Specifies that the file is suitable to use for a title of the item.

Type: Specifies the rendering properties and internal type of the field.

UniqueId: The reader MUST ignore this attribute.

UnlimitedLengthInDocumentLibrary: On a **Note** field or on a **Lookup** field for which the **Mult** attribute is TRUE, this specifies that the length of the content is not limited.

URLEncode: The reader MUST ignore this attribute.

URLEncodeAsURL: The reader MUST ignore this attribute.

UserSelectionMode: When present on a **User** field, PeopleOnly indicates that only principals that are users are selected, and PeopleAndGroups indicates that both principals that are users and those that are groups (2) can be selected.

UserSelectionScope: When present on a **User** field, specifies the group (2) to which the selected user or users belong.

Version: Current version of the field. The server MUST increment the value by 1 each time the field definition is changed. The client MUST ignore this attribute.

Viewable: Specifies whether or not the field was added to the default view of the list when it was added to the schema of the list. The reader SHOULD ignore this attribute.

WebId: For **Lookup** fields, specifies the identifier of the site that contains the list referenced by the List attribute.

Width: This attribute has the same semantics as the **Height** attribute except that it refers to the width of the image rather than the height.

WikiLinking: When TRUE on a Note field whose **RichText** attribute is TRUE, additional processing is done to facilitate entering hyperlinks within the content of the field. In other circumstances, the reader MUST ignore the attribute.

WorkflowStatusURL: The reader MUST ignore this attribute.

XName: String that is used to correlate the field in an external schema.

2.2.7.3.3.3 Child Elements

Customization: Provides an arbitrary XML document to provide vendor extensibility.

CHOICES: A set of **CHOICE** string elements that represent a list of available choices for a field. The reader MUST ignore **CHOICES** if the **Type** attribute is not **Choice** or **MultiChoice**. The writer SHOULD omit **CHOICES** if the **Type** attribute is not **Choice** or **MultiChoice**.<7>

Default: Default value of instances of data for this field in a list item. The reader MUST ignore this element when the **DefaultFormula** element is present and not empty.

DefaultFormula: Formula used to calculate the default value for this field in a list item.

DisplayBidiPattern: The implementation-specific XML that specifies the rendering of a **Computed** field to be used for a site with a locale identifier that specifies a bidirectional read order. A reader MUST ignore **DisplayBidiPattern** if the **Type** attribute is not **Computed**. The writer SHOULD omit **DisplayBidiPattern** if the **Type** attribute is not **Computed**.<8>

DisplayPattern: The implementation-specific XML that specifies the rendering of a **Computed** field. A reader MUST ignore **DisplayPattern** if the **Type** attribute is not **Computed**. The writer SHOULD omit **DisplayPattern** if the **Type** attribute is not **Computed**.<9>

FieldRefs: Specifies fields needed to render **DisplayPattern** or **DisplayBidiPattern**. **DisplayPattern** and **DisplayBidiPattern** MUST NOT use fields not listed in this element.

Formula: The formula used to calculate a value for a list item based on the value of other fields in the list. A reader MUST ignore **Formula** if the **Type** attribute is not **Calculated**. A writer SHOULD omit **Formula** if the **Type** attribute is not **Calculated**.<10>

FormulaDisplayNames: The **Formula** element formatted according to the regional settings of the site.

MAPPINGS: A set of **MAPPING** string elements that represents a canonical, language-agnostic identifier for a corresponding **CHOICE** with the value specified by the **MAPPING** element. The reader MUST ignore **MAPPINGS** if the **Type** attribute is not **Choice** or **MultiChoice**. The writer SHOULD omit **MAPPINGS** if the **Type** attribute is not **Choice** or **MultiChoice**.<11>

ParserRefs: Specifies alternate names for the field when accessed by the parsers listed in child elements of this element.

Validation: The implementation-specific XML that specifies the validation criteria to be used for items in this list.

2.2.7.3.4 FieldDefinitionDatabase

The **FieldDefinitionDatabase** type provides an overall container for field definitions in a Content Database.

2.2.7.3.4.1 Schema

```
<xs:complexType name="FieldDefinitionDatabase">
  <xs:sequence>
    <xs:element name="Index" type="IndexDefinitionTP" minOccurs="0" maxOccurs="unbounded"
  />
    <xs:choice minOccurs="0" maxOccurs="unbounded">
      <xs:element name="FieldRef" type="FieldRefDefinitionTP" />
      <xs:element name="Field" type="FieldDefinitionTP" />
    </xs:choice>
  </xs:sequence>
</xs:complexType>
```

2.2.7.3.4.2 Attributes

None.

2.2.7.3.4.3 Child Elements

Index: Specifies a composite field index to be used in this list.

FieldRef: Specifies a reference to an existing field definition that is used in the current list.

Field: Specifies either a definition of a new field definition to be used in this list, or a reference to an existing field that was deleted.

2.2.7.3.5 FieldDefinitionDatabaseWithVersion

The **FieldDefinitionDatabaseWithVersion** type provides an overall container for field definitions in **tp_Fields**, specified as follows.

2.2.7.3.5.1 Schema

```
<xs:complexType name="FieldDefinitionDatabaseWithVersion" mixed="true">
  <xs:all>
    <xs:element name="tp_Fields" type="FieldDefinitionDatabase" minOccurs="1"
  maxOccurs="1"/>
  </xs:all>
</xs:complexType>
```

2.2.7.3.5.2 Attributes

None.

2.2.7.3.5.3 Child Elements

tp_Fields: Specifies a collection of field definitions that are stored in a content database.

<Content>: The body text of this element MUST contain a string with the following pattern and MUST precede any child elements.

```
([0-9][0-9]*[.]) ([0-9][0-9]*[.]) ([0-9] [0-9]*[.]) ([0-9][0-9]*[.]) ([0-9][0-9]*[.]) ([0-9][0-9]*)
```

The first two groups MUST correspond to the major version and minor version of the product. The second two groups MUST correspond to the revision version and build number of the product. The last two groups MUST correspond to the revision of the field definitions on the list and the list's template, respectively.

2.2.7.3.6 FieldDefinitionTP

The **FieldDefinitionTP** type specifies a field and its associated components. **FieldDefinitionTP** has the same structure as **FieldDefinition**. However, if only the ID attribute of **FieldDefinitionTP** is specified, the element specifies a field definition that was deleted by a user on a front-end Web Server.

2.2.7.3.6.1 Schema

```
<xs:complexType name="FieldDefinitionTP">
  <xs:complexContent>
    <xs:extension base="FieldDefinition">
      <xs:attribute name="Type" type="xs:string" use="optional" />
    </xs:extension>
  </xs:complexContent>
</xs:complexType>
```

2.2.7.3.6.2 Attributes

See **FieldDefinition** (section [2.2.7.3.3](#)).

2.2.7.3.6.3 Child Elements

See **FieldDefinition** (section [2.2.7.3.3](#)).

2.2.7.3.7 FieldParserRef

The **FieldParserRef** type allows schema authors to override the **Name** attribute of a **FieldDefinition** type (section [2.2.7.3.3](#)) for a specific parser.

2.2.7.3.7.1 Schema

```
<xs:complexType name="FieldParserRef">
  <xs:attribute name="Name" type="xs:string" />
  <xs:attribute name="ProgId" type="xs:string" />
</xs:complexType>
```

2.2.7.3.7.2 Attributes

Name: Specifies an alternative **Name** to provide to the parser specified by the **ProgId** attribute when describing the field.

ProgId: Specifies the parser to which to provide the alternative **Name**.

2.2.7.3.7.3 Child Elements

None.

2.2.7.3.8 FieldParserRefs

The **FieldParserRefs** type allows schema authors to override the **Name** attribute of a **FieldDefinition** type (section [2.2.7.3.3](#)) for a collection of parsers.

2.2.7.3.8.1 Schema

```
<xs:complexType name="FieldParserRefs">
  <xs:sequence>
    <xs:element name="ParserRef" type="FieldParserRef" minOccurs="0" maxOccurs="unbounded"
  />
  </xs:sequence>
</xs:complexType>
```

2.2.7.3.8.2 Attributes

None.

2.2.7.3.8.3 Child Elements

ParserRef: Specifies the overridden **Name** for a specific parser.

2.2.7.3.9 FieldRefDefinitionField

The **FieldRefDefinitionField** type specifies field definitions that are referenced within another field definition.

2.2.7.3.9.1 Schema

```
<xs:complexType name="FieldRefDefinitionField" mixed="true" >
  <xs:attribute name="Name" type="xs:string" use="required" />
  <xs:attribute name="ID" type="UniqueIdentifierWithOrWithoutBraces" use="optional" />
  <xs:attribute name="ShowField" type="xs:string" use="optional" />
  <xs:attribute name="RefType" type="FieldRefType" use="optional" />
  <xs:attribute name="CreateURL" type="xs:string" use="optional" />
  <xs:attribute name="Key" type="xs:string" use="optional" />
  <xs:attribute name="DisplayName" type="xs:string" use="optional" />
  <xs:attribute name="Format" type="xs:string" use="optional" />
</xs:complexType>
```

2.2.7.3.9.2 Attributes

See attributes section of **FieldDefinition** (section [2.2.7.3.3](#)).

Name: Specifies the **Name** attribute of the referenced field.

ID: Specifies the **ID** attribute of the referenced fields. When both **ID** and **Name** are specified, the reader MUST use **ID** first and fall back to **Name** if the **ID** does not match.

ShowField: Specifies an alternate value for the **ShowField** attribute on a lookup field when rendering in the context of a computed field.

RefType: It describes the type of reference of the field in an events list. This MUST be a **FieldRefType** as specified in section [2.2.7.2.4](#). In other cases, this attribute MUST NOT be present.

CreateURL: The URL to create a Meeting Workspace site. If the **RefType** is **LinkURL**, this attribute MUST be present. Otherwise it MUST NOT be present.

Key: If this value of this attribute is set to "Primary", the server MUST give this field priority in the ordering of the items.

DisplayName: The reader MUST ignore this attribute.

Format: This attribute is only used if the referenced field is DateTime type. If the value of this attribute is set to "Original", the referenced field value will not get rendered.

2.2.7.3.9.3 Child Elements

<content>: Describes the Meeting Workspace site created by the URL in **CreateURL**. If the **RefType** attribute is present and has the value LinkURL, then the element MUST have content. In other cases, the reader MUST ignore any content.

2.2.7.3.10 FieldRefDefinitionIndex

The **FieldRefDefinitionIndex** type specifies a field to use in a composite field index.

2.2.7.3.10.1 Schema

```
<xs:complexType name="FieldRefDefinitionIndex">
  <xs:attribute name="ID" type="UniqueIdentifierWithBracesUppercase" use="required" />
</xs:complexType>
```

2.2.7.3.10.2 Attributes

ID: Identifies a field for which the server can optimize queries.

2.2.7.3.10.3 Child Elements

None.

2.2.7.3.11 FieldRefDefinitionTP

The **FieldRefDefinitionTP** type specifies a reference to a field definition. The attributes specified here override existing values in the field definition.

2.2.7.3.11.1 Schema

```
<xs:complexType name="FieldRefDefinitionTP">
  <xs:attribute name="Name" type="xs:string" use="required" />
  <xs:attribute name="ColName" type="xs:string" use="optional" />
  <xs:attribute name="ColName2" type="xs:string" use="optional" />
  <xs:attribute name="RowOrdinal" type="xs:int" default="0" use="optional" />
  <xs:attribute name="RowOrdinal2" type="xs:int" default="0" use="optional" />
  <xs:attribute name="ID" type="UniqueIdentifierWithOrWithoutBraces" use="optional" />
</xs:complexType>
```

```
<xs:attribute name="SourceID" type="xs:string" use="optional" />
<xs:attribute name="StaticName" type="xs:string" use="optional" /> </xs:complexType>
```

2.2.7.3.11.2 Attributes

See **FieldDefinition** (section [2.2.7.3.3](#)).

2.2.7.3.11.3 Child Elements

None.

2.2.7.3.12 IndexDefinitionTP

The **IndexDefinitionTP** type specifies a composite field index. A server can optimize for queries that filter on the fields specified within the composite field index.

2.2.7.3.12.1 Schema

```
<xs:complexType name="IndexDefinitionTP">
  <xs:sequence>
    <xs:element name="FieldRef" type="FieldRefDefinitionIndex" minOccurs="2" maxOccurs="2" />
  </xs:sequence>
  <xs:attribute name="ID" type="UniqueIdentifierWithBracesUppercase" use="required" />
</xs:complexType>
```

2.2.7.3.12.2 Attributes

ID: Identifier for the composite field index.

2.2.7.3.12.3 Child Elements

FieldRef: Specifies a reference to an existing field definition that is used in the current list.

2.2.7.3.13 MAPPINGDEFINITION

The **MAPPINGDEFINITION** type defines a canonical value for localizable **CHOICE** entries. Each **MAPPINGDEFINITION** MUST define in its contents a corresponding value from a choice.

2.2.7.3.13.1 Schema

```
<xs:complexType name="MAPPINGDEFINITION">
  <xs:simpleContent>
    <xs:extension base="xs:string">
      <xs:attribute name="Value" type="xs:string" />
    </xs:extension>
  </xs:simpleContent>
</xs:complexType>
```

2.2.7.3.13.2 Attributes

Value: String which contains a canonical, non-localizable value for a **CHOICE**.

2.2.7.3.13.3 Child Elements

<content>: Contains a string that MUST specify exactly the string of a corresponding **CHOICE**.

2.2.7.3.14 MAPPINGDEFINITIONS

The **MAPPINGDEFINITIONS** type is a container for one or more **MAPPINGS**. **MAPPINGS** MUST NOT be defined for field types other than **Choice** or **MultiChoice**. There MUST be either no **MAPPINGDEFINITION** elements defined for a **Choice** field, or exactly one **MAPPING** element for each corresponding **CHOICE** element.

2.2.7.3.14.1 Schema

```
<xs:complexType name="MAPPINGDEFINITIONS">
  <xs:sequence>
    <xs:element name="MAPPING" type="MAPPINGDEFINITION" minOccurs="0" maxOccurs="unbounded"
  />
  </xs:sequence>
</xs:complexType>
```

2.2.7.3.14.2 Attributes

None.

2.2.7.3.14.3 Child Elements

MAPPING: A canonical value mapping for a **CHOICE**.

2.2.7.4 Elements

This specification does not define any common XML schema element definitions.

2.2.7.5 Attributes

This specification does not define any common XML schema attribute definitions.

2.2.7.6 Groups

This specification does not define any common XML schema group definitions.

2.2.7.7 Attribute Groups

This specification does not define any common XML schema attribute group definitions.

2.2.8 User-Defined Table Types

2.2.8.1 tvpBSNMetadata

The **tvpBSNMetadata** table type represents an array of values to identify a stream binary piece.

The **tvpBSNMetadata** table type is defined using T-SQL syntax, as follows.

```
TYPE tvpBSNMetadata AS TABLE (
  DocId uniqueidentifier NULL,
```



```

        Partition tinyint NULL,
        BSN bigint NULL,
        StreamId bigint NULL,
        Type tinyint NULL,
        Size int NULL
    );

```

DocId: The document identifier (2) for the document that is associated with the stream binary piece.

Partition: The stream partition that contains the stream binary piece.

BSN: The BLOB sequence number of the stream binary piece.

StreamId: The stream identifier of the stream binary piece.

Type: The stream (1) type of the stream binary piece.

Size: The size, in bytes, of the stream binary piece.

2.2.8.2 tvpBSNMetadata2

The **tvpBSNMetadata2** table type represents an array of values to identify a stream binary piece.

The **tvpBSNMetadata2** table type is defined using T-SQL syntax, as follows.

```

TYPE tvpBSNMetadata2 AS TABLE (
    DocId uniqueidentifier NULL,
    Partition tinyint NULL,
    BSN bigint NULL,
    StreamId bigint NULL,
    Type tinyint NULL,
    Size int NULL,
    Expiration datetime NULL
);

```

DocId: The document identifier (2) for the document that is associated with the stream binary piece.

Partition: The stream partition that contains the stream binary piece.

BSN: The BLOB sequence number of the stream binary piece.

StreamId: The stream identifier of the stream binary piece.

Type: The stream (1) type of the stream binary piece.

Size: The size, in bytes, of the stream binary piece.

Expiration: The timestamp in UTC format of when the stream binary piece expires.

2.2.8.3 tvpStreamData

The **tvpStreamData** Table Type represents an array of values to identify a stream binary piece and its data. It is defined using T-SQL syntax, as follows.

```
TYPE tvpStreamData AS TABLE (  
    BSN bigint NULL,  
    Data varbinary(max) NULL,  
    Offset bigint NULL,  
    Length int NULL,  
    RbsId varbinary(64) NULL  
);
```

BSN: The BLOB sequence number of the stream binary piece.

Data: If the stream binary piece is not stored in remote BLOB storage, this value **MUST** contain a subset of the binary data of the stream binary piece, otherwise it **MUST** be NULL. See definition for format.

Offset: The offset into the stream binary piece where this subset data belongs.

Length: The size, in bytes, of this subset data of the stream binary piece.

RbsId: If this stream binary piece is stored in remote BLOB storage, this value **MUST** contain the remote BLOB storage identifier of a subset of the binary data of the stream binary piece. Otherwise it **MUST** be NULL. For additional information regarding remote BLOB storage, see [\[MS-WSSO\]](#) section 2.1.2.3.8.

3 Protocol Details

3.1 Back-End Database Server Details

3.1.1 Abstract Data Model

This section describes a conceptual model of possible data organization that an implementation maintains to participate in this protocol. The described organization is provided to facilitate the explanation of how the protocol behaves. This document does not mandate that implementations adhere to this model, as long as their external behavior is consistent with the behavior described in this document.

The back-end database server maintains the following sets of data for this protocol within both a Configuration Database and one or more content databases. Data within these databases is maintained until updated or removed.

Configuration Objects: A set of information about farm configuration. The Configuration Objects are stored in a Configuration Database.

Site Map: A set of information mapping URLs for site collections to site collection identifiers, and the content databases that contain each site collection's data. The **Site Map** is stored in the Configuration Database. **Site Map** entries are identified by site collection identifiers and also are represented by either absolute URLs or store-relative form URLs.

Versions: A set of information indicating the current version information for various components in the farm.

Site Collections: A set of information about all site collections in a content database. Site collection entries are identified by site collection identifiers and are also represented by either absolute URLs or store-relative form URLs.

Sites: A set of information about all sites in a content database. Site entries are identified by site identifiers and are also represented by store-relative form URLs.

Lists: A set of information about all lists (1) in a content database. List entries are identified by list identifiers and are also represented by store-relative form URLs.

List Items: A set of information about all list items in a content database. List item entries are identified by **list item identifiers**.

Documents: A set of information about all documents in a content database. Document entries are identified by document identifiers (2) and are also are represented by store-relative form URLs.

Users: A set of information about all users in a content database. User entries are identified by user identifiers.

Site Groups: A set of information about all permission levels in a content database. Site group entries are identified by site group identifiers.

Roles: A set of information about all roles in a content database. Role entries are identified by **role identifiers**.

3.1.2 Timers

An execution timeout timer is set up on the back-end database server to govern the execution time for any requests. The amount of time is governed by a time-out value configured on the back-end database server for all connections.

3.1.3 Initialization

Authentication of the TDS connection to the back-end database server **MUST** occur before this protocol can be used.

The data structures, stored procedures, and actual data are persisted by the back-end database server within databases, so any operations to initialize the state of the database **MUST** occur before the back-end database server can use this protocol. This protocol requires that the data for site collections, sites, lists, and document libraries already exist within the back-end database server in a valid state.

3.1.4 Higher-Layer Triggered Events

None.

3.1.5 Message Processing Events and Sequencing Rules

The T-SQL syntax for each Stored Procedure and Result Set, and the variables they are composed of, is defined using the T-SQL language specified in [\[TSQL-Ref\]](#). In the T-SQL syntax, the variable name is followed by the type of the variable, which can optionally have a length value in brackets and can optionally have a default value indicated by an equal sign followed by the default value. Unless otherwise specified, all Stored Procedures defined in this section are located in the Content Database.

For definitional clarity, a name has been assigned to any columns in the result sets that do not have a defined name in their current implementation. This does not affect the operation of the result set, because the front-end Web server can access any column with no defined name by ordinal position. Such names are designated in the text using braces in the form {name}. For interoperability, named columns in Result Sets are specified with what they **SHOULD** be named, and columns marked with braces **SHOULD** have no defined name. front-end Web server implementations **MUST NOT** rely on any column name in a Result Set.

The logical sequence of returned values and result sets are indicated in each of the individual Stored Procedures defined in this section. The TDS protocol controls the actual order and structure of how the T-SQL language formatted information is transported over the wire.

All functions, result sets, and stored procedures are defined using T-SQL. The following table lists the functions, result sets, and stored procedures in this section.

| Name | Description |
|--------------------------------|--|
| fn_GetFullUrl | Constructs a full URL from two component parts. |
| proc_AddBuildDependency | Associates a build dependency with a specified document. |
| proc_AddDocument | Adds a document to the back-end database server with the specified parameters. |

| Name | Description |
|---|--|
| proc_AddListItem | Adds a list item to a list. |
| proc_ChangeLevelForDoc | Updates the publishing level of a document. |
| proc_CheckRbsInstalled | Tests whether the back-end database server can support remote BLOB storage. |
| proc_CheckoutDocument | Places a short-term lock on a document, refreshes, converts or releases an existing short-term lock, or checks out a document. |
| proc_ClearLinks | Deletes all link information associated with a particular field (2) in a list item as part of a list item or document update. |
| proc_CreateDir | Creates a directory or folder with a specified name at a specified location. |
| proc_DeleteAllDocumentVersions | Deletes either the draft versions or older published versions of a document and optionally places them in the recycle bin. |
| proc_DeleteDocBuildDependencySet | Deletes a build dependency set for a specified document. |
| proc_DeleteDocumentVersion | Deletes a document version and optionally places it in the recycle bin. |
| proc_DeleteUrl | Deletes a document. |
| proc_DisableRbs | Prepares the back-end database server to stop storing content in remote BLOB storage, and reclaims any back-end database server resources allocated with proc_EnableRbs . |
| proc_DirtyDependents | Marks all items that depend on a given document, configuration setting, navigation structure, or usage statistic as "dirty", so that subsequent action can be taken to update them as necessary. |
| proc_EnableRbs | Prepares the back-end database server to store content in remote BLOB storage. |
| proc_EnumLists | Returns a list of the lists (1) in a site (2), along with their associated metadata. |
| proc_ReadStream | Reads a specific range of data from a document's stream binary piece. |
| proc_FetchDocForHttpGet | Fetches a document stream and provides information necessary to render the document on a front-end Web server. |
| proc_FetchDocForRead | Requests the metadata information and document stream of a document. |

| Name | Description |
|--|--|
| proc_FetchDocForUpdate | Requests document content and metadata information. It also updates the CacheParseId flag for the requested document if the <i>@CacheParse</i> parameter is set to 1. |
| proc_FetchWelcomeNames | Lists all the names of the default welcome pages used as redirection targets when folders are requested by an HTTP GET in all site collections in the back-end database server. |
| proc_GenerateNextId | Returns an identifier to be used for a new list item in a specified list, and to increment the value of the identifier returned by the next call to this procedure for the same List. |
| proc_GetAllRolesForUser | Retrieves the role identifiers for the roles assigned to a set of principals in a given security scope. |
| proc_GetAuditMask | Identifies Audit Flags (section 2.2.2.1) information for a specified object. |
| proc_GetAuditMaskOutput | Gets Audit Flags (section 2.2.2.1) information about an object. |
| proc_GetContainingList | Gets metadata and event receiver information about the list containing a specified URL. |
| proc_GetContainingListCore | Gets metadata and event receiver information about the list containing a specified URL. |
| proc_GetDocsMetaInfo | Requests document metadata information for up to ten documents within a specified site (2). |
| proc_GetLinkInfoSingleDoc | Provides link information and status for all forward links within a specified document and for all backward links within the specified site collection to the document. |
| proc_GetListCheckedOutFiles | Retrieves a list of all documents with a Document Store Type (section 2.2.2.4) of 0 (File) within a specified list, folder, or its subfolders, which are checked out and do not have checked in draft or published versions. |
| proc_GetListFields | Gets the mapping of fields (2) in a list. |
| proc_GetListMetaAndEventReceivers | Retrieves information about the metadata, security scopes, Web Parts, and event receivers for a specified list. |
| proc_getObject | Retrieves a single Configuration Object |

| Name | Description |
|---|--|
| | (section 2.2.5.1) from the Configuration Database (section 3.1.1). |
| proc_getObjectsByBaseClass | Returns a list of GUIDs for child Configuration Objects (section 2.2.5.1) of the specified parent Configuration Object that inherit from the specified base Class (section 2.2.5.1.1). |
| proc_getObjectsByClass | Retrieves the GUIDs of Configuration Objects (section 2.2.5.1) based upon the Class type (section 2.2.5.1.1), the parent Configuration Object, and the Name (section 2.2.5.1.3) of the Configuration Object. |
| proc_GetSiteFlags | Returns the Site Collection Flags (section 2.2.2.9) set for a specified site collection. |
| proc_getSiteMap | Determines the Site Map (section 3.1.5.38.1) information for a site collection. |
| proc_getSiteMapById | Determines the complete Site Map (section 3.1.5.38.1) information for a site collection. |
| proc_GetTpWebMetaDataAndListMetaData | Retrieves metadata for a particular site (2) or list (1). |
| proc_GetUniqueScopesInList | Gets the WSS ACL Format (section 2.2.3.6) information for all the unique security scopes of folders and list items contained in a specified list. |
| proc_GetVersion | Gets the component version number string associated with the specified version identifier GUID. |
| proc_GetWebMetaInfo | Requests metadata information for a site. |
| proc_GetWebMetaInfoByUrl | Requests site metadata information for the site (2) containing a specified Uniform Resource Locator (URL). |
| proc_ListDocumentVersions | Lists all available version history information for a specified document. |
| proc_ListRbsStores | Enumerates the remote BLOB storage stores with which the back-end database server has been configured, if any. |
| proc_ListUrls | Retrieves metadata for a document specified by a URL and the documents contained within it, if any. |
| proc_RenameUrl | Renames a document or folder within a specified site. |

| Name | Description |
|--------------------------------------|--|
| proc_SecAddPrincipalToRole | Adds a security principal to a role defined within a site collection. |
| proc_SecAddRoleDef | Creates a new role definition for a specified site within a site collection. |
| proc_SecAddUser | Adds a new entry for a security principal to the UserInfo Table (section 2.2.6.10) that contains descriptive properties and security information about security principals, and is stored in the back-end database server. |
| proc_SecAddUserToSiteGroup | Adds a user to a permission level in the site collection. |
| proc_SecAddWebMembership | Associates an existing user within a site collection to a site within the same site collection. |
| proc_SecChangeToInheritedList | Changes the scope of the specified list to the specified site and remove any role assignments and permission settings specific to the list. |
| proc_SecChangeToInheritedWeb | Changes a site from having its own unique permissions to instead use the permissions inherited from its nearest ancestor with unique permissions. |
| proc_SecChangeToUniqueScope | Sets a securable object such as a site, list, or document library to use its own unique security scope, instead of inheriting its security scope from the first ancestor with uniquely permissions. |
| proc_SecCheckDeletedAccounts | Checks whether a login name exists in the site collection. |
| proc_SecCloneRoleDefinitions | Creates a copy of the current role definition for a site. |
| proc_SecCreateSiteGroup | Adds a new permission level to a site collection. |
| proc_SecDecCurrentUsersCount | Reduces by one the total number of users in the specified site collection when configured to use Active Directory account creation mode . |
| proc_SecGetAccountStatus | Provides status information for a site collection's users, which are not marked as deleted, and match the specified login name or email address. |
| proc_SecGetAclFromScope | Obtains the Access Control List and the anonymous User permissions for a given scope. |

| Name | Description |
|--|--|
| proc_SecGetAllAclsForSite | Lists all Scope Identifiers and their associated ACL and anonymous permission masks in a site collection. |
| proc_SecGetAllGroupsAndMembershipInfo | Returns information about all site groups and site group members (1) within a site collection. |
| proc_SecGetApplicationPrincipalAndUserToken | Returns information about a principal based on the principal's login name and user identifier. |
| proc_SecGetCompleteWebRoleMemberList | Lists all role assignments for all the principals with permissions on a specified Site. |
| proc_SecGetCurrentUsersCount | Returns a result set containing a count of Users in the specified site collection. |
| proc_SecGetDomainGroupMapData | Retrieves the domain group map cache information for a site collection. |
| proc_SecGetGroupById | Checks whether the specified Group (either a site group or a domain group) exists in the specified site collection. |
| proc_SecGetGroupOwner | Retrieves the User Identifier or Site Group Identifier for the owner of a site group. |
| proc_SecGetGroupSecurityScopes | Retrieves a site group's role assignments information on all security scopes within a given site collection. |
| proc_SecGetIndividualUriSecurityCheckEventReceivers | Requests security information and event receiver information about a document at a specified location. |
| proc_SecGetItemsWithUniquePermissions | Returns information about list items with unique permissions. |
| proc_SecGetPrincipalByEmail | Returns user information about a user associated with a specified email address. |
| proc_SecGetPrincipalById | Returns information about a principal or collection of principals based on a specified site group identifier or user identifier. |
| proc_SecGetPrincipalByIdEx | Returns information about a principal based on a specified user identifier or a collection of principals based on a specified site group identifier. |
| proc_SecGetPrincipalByLogin | Returns security and attribute information for a principal (a user or domain group) identified by a specified login name. |
| proc_SecGetPrincipalByLogin20 | Returns security principal information based on up to 20 separate login names. |

| Name | Description |
|--|---|
| proc_SecGetPrincipalDisplayInformation20 | Returns security principal or site group information for up to 20 principal identifiers. |
| proc_SecGetRoleAssignments | Requests the WSS ACE (section 2.2.3.5) for a specified security scope in a site collection. |
| proc_SecGetRoleBindingsForAllPrincipals | Lists the role assignments for all principals in a security scope. |
| proc_SecGetRoleDefs | Retrieves role definition information for items in the specified site collection and scope. |
| proc_SecGetSecurityInfo | Retrieves security permissions information about a document. |
| proc_SecGetSiteAdmins | Returns a list of all site collection administrators not marked as deleted. |
| proc_SecGetSiteGroupById | Gets information about a site group given its ID. |
| proc_SecGetSiteGroupByTitle | Gets site group information for the site group with the specified user-friendly name. |
| proc_SecGetSiteGroupByTitle20 | Provides information about site groups in bulk, as specified by a set of up to 20 site group titles. |
| proc_SecGetUserAccountDirectoryPath | Returns the User Account Directory Path of a specified site collection. |
| proc_SecGetUserPermissionOnGroup | Determines what permissions the requesting user has within a specified site group. |
| proc_SecGetWebsAndListWithUniquePermissions | Returns a list of sites and lists that have unique permissions. |
| proc_SecListAllSiteMembers | Provides information about all non-deleted security principals in the specified site collection. |
| proc_SecListAllWebMembers | Lists all non-deleted user and domain group accounts registered with a specified site. |
| proc_SecListGroupsWithRole | Lists all site groups that have the specified role. |
| proc_SecListScopeGroups | Lists all site groups that have role assignments in a specified scope. |
| proc_SecListScopeUsers | Lists information about users and domain groups with a direct role assignment association with the specified scope, |

| Name | Description |
|---|--|
| | rather than by membership in a site group with a role assignment association with the scope. |
| proc_SecListSiteGroupMembership | Lists members (1) in a specified site group. |
| proc_SecListSiteGroups | Lists site group information for a specified site collection. |
| proc_SecListSiteGroupsContainingUser | Lists the site groups in which the user is a member (1). |
| proc_SecListSiteGroupsWhichUserOwns | Returns site group information for the site groups owned by the specified principal. |
| proc_SecListUsersInRole | Lists the non-deleted principals assigned to a specified role in the specified scope. |
| proc_SecMigrateUser | Updates the SystemID and login name for a principal in the UserInfo Table (section 2.2.6.10) and AllUserData Table (section 2.2.6.2). |
| proc_SecReCalculateWebFGP | Updates the bit at 0x00000400 of the Site Property Flags (section 2.2.2.11) to indicate whether the site has at least one uniquely secured object within it. |
| proc_SecRefreshToken | Updates the UserInfo Table (section 2.2.6.10) with information about a specified user's membership in external groups. |
| proc_SecRemoveGroup | Removes a site group from a site collection. |
| proc_SecMarkGroupForWebDelete | Marks a site group for later removal from a site collection. |
| proc_SecRemovePrincipalFromScope | Removes a principal from a security role associated with a site in a specified security scope. |
| proc_SecRemoveRoleDef | Removes a role definition, and any role assignments which use that role definition, from a specified site. |
| proc_SecRemoveUserFromScopeByLogin | Removes a user, specified by login name, from a role in a specified security scope. |
| proc_SecRemoveUserFromSite | Removes a user from a site collection. |
| proc_SecRemoveUserFromSiteGroup | Removes a user from a site group in a site collection. |
| proc_SecRemoveUserFromSiteGroupByLogin | Removes a user identified by login name from a specified site group. |

| Name | Description |
|--|--|
| proc_SecResetItemPerm | Causes a list item to revert its set of permissions so that it inherits permissions from its parent rather than has its own. |
| proc_SecResetWebToDefaultRoleDefinition | Replaces existing roles, role assignments, and Permissions for a specified site (2) and its subsites with a default set of role definitions, as specified by input parameters. |
| proc_SecResolvePrincipal | Retrieves information about a principal or site group in the specified site collection, given the principal's login name, e-mail address, or display name. |
| proc_SecSetSiteGroupProperties | Updates properties of a site group. |
| proc_SecSetUserAccountDirectoryPath | Sets or clears the user account directory path for a specified site collection. |
| proc_SecSetWebRequestAccess | Sets the request access email address for a specified site. |
| proc_SecUpdateAnonymousPermMask | Modifies the permissions for the anonymous user. |
| proc_SecUpdateDomainGroupMapData | Updates the domain group map cache of a specified site collection. |
| proc_SecUpdateRoleDef | Updates a role definition with a new title, description, display order, Role Definition Type (section 2.2.1.2.16), and WSS Rights Mask (section 2.2.2.15). |
| proc_SecUpdateUser | Updates the display name, e-mail address, notes, or administrative privileges listed in the user information associated with a principal. |
| proc_SecUpdateUserActiveStatus | Marks a user as an active user in a site collection. |
| proc_TakeOverCheckOut | Overrides checkout for a document that is checked out and has no checked-in draft or published version. |
| proc_UncheckoutDocument | Releases a checked out document. |
| proc_UpdateDocBuildDependencySet | Stores an updated version of a build dependency set for a specified document. |
| proc_UpdateDocument | Updates the metadata and stream (1) of a document. |
| proc_UpdateListItem | Updates a list item in a document library or list. |
| proc_UpdateListSettings | Updates list (1) metadata. |

| Name | Description |
|---|--|
| proc_UpdateUserInfoInTableFromRowUpdater | Updates the user information data for the specified user. |
| proc_UrlToWebUrl | Returns the store-relative form URL of the site that contains a specified store-relative form URL and is inside a specific site collection. |
| proc_WriteChunkToAllDocStreams | Establishes new document content associated with the document specified by <i>@DocId</i> or appends to already existing document content established by an earlier invocation of proc_WriteChunkToAllDocStreams . |
| proc_WriteStreamToRBS | Establishes the remote BLOB storage identifier representing a new stream binary piece for a document. |
| proc_WriteStreams | Creates a new stream binary piece for a document. |
| proc_WriteStreamToSQL | Creates a new stream binary piece for a document. |
| proc_SetStreamsToDoc | Associates stream binary pieces with a document. |
| proc_SetStreamsToDocNoTVP | Associates stream binary pieces with a document. |
| TVF_Docs_Url_Level | Returns a subset of rows from the Docs View (section 2.2.6.3). |
| TVF_UserData_ListItemLevelRow | Returns a subset of rows from the UserData View (section 2.2.6.8). |
| TVF_UserData_PId_DId_Level_Row | Returns a subset of rows from the UserData View (section 2.2.6.8). |
| proc_HasCurrentPublishVersion | Tests whether the specified list item has a current published version. |

3.1.5.1 fn_GetFullUrl

The **fn_GetFullUrl** function is invoked to construct a full URL from two component parts.

```

FUNCTION fn_GetFullUrl(
    @DirName          nvarchar(256),
    @LeafName         nvarchar(128)
)
RETURNS              nvarchar(260)

```

@DirName: The directory name component of the full URL.

@LeafName: The leaf name component of the full URL.

Return Values: The full URL, which is formed from *@DirName* and *@LeafName* as follows:

If *@DirName* is an empty string, then *@LeafName* MUST be returned. If *@LeafName* is an empty string, then *@DirName* MUST be returned. If either *@DirName* or *@LeafName* is NULL, then NULL MUST be returned. Otherwise **fn_GetFullUrl** MUST return *@DirName* + '/' + *@LeafName*.

3.1.5.2 **proc_AddBuildDependency**

The **proc_AddBuildDependency** stored procedure is invoked to associate a build dependency with a specified document.

```
PROCEDURE proc_AddBuildDependency(  
    @DocSiteId                uniqueidentifier,  
    @DocDirName               nvarchar(256),  
    @DocLeafName              nvarchar(128),  
    @TargetDirName            nvarchar(256),  
    @TargetLeafName           nvarchar(128),  
    @DirectDependency         bit,  
    @RequestGuid              uniqueidentifier = NULL OUTPUT  
);
```

@DocSiteId: The Site Collection Identifier (section [2.2.1.1.9](#)) for the site collection that contains the document. This parameter MUST NOT be NULL.

@DocDirName: The directory name of the document in store-relative form. This parameter MUST NOT be NULL.

@DocLeafName: The leaf name of the document. This parameter MUST NOT be NULL.

@TargetDirName: The directory name of the item to declare as a dependency of the document. This parameter MUST NOT be NULL.

@TargetLeafName: The leaf name of the item to declare as a dependency of the document. This parameter MUST NOT be NULL.

@DirectDependency: Set to 1 if the target is a direct dependency. Set to 0 if indirect, such as a dependency of a dependency. This parameter MUST NOT be NULL.

@RequestGuid: The optional **request identifier** for the current request.

Return Values: The **proc_AddBuildDependency** stored procedure MUST return an integer return code of 0. The **proc_AddBuildDependency** stored procedure MUST NOT return a result set.

3.1.5.3 **proc_AddDocument**

The **proc_AddDocument** stored procedure is invoked to add a document to the back-end database server with the specified parameters.

```
PROCEDURE proc_AddDocument(  
    @DocSiteId                uniqueidentifier,  
    @DocWebId                 uniqueidentifier,  
    @UserId                   int,  
    @AppPrincipalId           int,  
    @AuthorId                 int,  
    @DocDirName               nvarchar(256),  
    @DocLeafName              nvarchar(128)    OUTPUT,
```

```

@Level tinyint,
@UIVersion int = 512,
@NewDocId uniqueidentifier,
@DocLibId uniqueidentifier,
@NewDocLibRowId int,
@SendingContent bit,
@DocMetaInfo varbinary(max),
@DocSize int,
@DocMetaInfoSize int,
@DocFileFormatMetaInfo varbinary(max),
@DocFileFormatMetaInfoSize int,
@EnableMinorVersions bit,
@IsModerated bit,
@DocDirty bit,
@DocFlags int,
@DocIncomingCreatedDTM datetime,
@DocIncomingDTM datetime,
@GetWebListForNormalization bit,
@PutFlags bigint,
@CreateParentDir bit,
@UrlIsSuggestion bit,
@ThicketMainFile bit,
@CharSet int,
@ProgId nvarchar(255),
@AttachmentOp int,
@VirusVendorID int,
@VirusStatus int,
@VirusInfo nvarchar(255),
@VirusInfoEx varbinary(max),
@LockTimeout int,
@SharedLock bit,
@Comment nvarchar(1023),
@DocDTM datetime OUTPUT,
@fNoQuotaOrLockCheck bit,
@DocContentVerBump int,
@BSNBump bigint,
@StreamSchema tinyint,
@DocClientId varbinary(16) = NULL,
@RequestGuid uniqueidentifier = NULL OUTPUT
);

```

@DocSiteId: The site collection identifier for the site collection that will contain the document to be stored. This MUST NOT be NULL.

@DocWebId: The site identifier for the site that will contain the document to be stored. This MUST NOT be NULL.

@UserId: The user identifier of the current user making the request to the front-end Web server. This value MUST refer to an existing user identifier for the specified site collection.

@AppPrincipalId: The app principal identifier of the **app (1)** that is requesting this operation. If the operation was not requested by an app (1) then it MUST be set to 0.

@AuthorId: The user identifier to use instead of **@UserId's** value in the owner fields of the document, if the publishing level is set to draft or checked out or the document has a short-term lock applied. If NULL is specified, **@UserId** is used in the owner fields.

@DocDirName: The directory name of the document to be stored. This MUST NOT be NULL.

@DocLeafName: The leaf name of the document to be stored. If *@UrlIsSuggestion* is set to "1", this name MUST be replaced with a unique name if the name is not unique and is returned in this output parameter as the actual document leaf name. This parameter MUST NOT be NULL.

@Level: The publishing level type value (section [2.2.2.6](#)) for the document to be stored. This MUST be a valid value.

@UIVersion: The UI version number to associate with this document. This MUST NOT be NULL.

@NewDocId: The document identifier (section [2.2.1.1.2](#)) of the document to be stored. This MUST NOT be NULL, MUST be unique for a new document, and MUST be the same for an existing document adding a new publishing level.

@DoclibId: The list identifier (section [2.2.1.1.5](#)) of the list (1) or document library into which the document is to be stored. This MUST only be NULL when a document is not being added to a list (1) or document library.

@NewDoclibRowId: The identifier for a row in a document library for the document to be stored. This MUST be NULL if the document is not in a list (1) or document library.

@SendingContent: Specifies whether to store the document stream in the back-end database server. This field MUST be one if the document stream of the document is intended to be stored in the back-end database server; otherwise, it MUST be zero.

@DocMetaInfo: The metadata information for the document to be stored. If there is no metadata information for this document, this parameter MUST be NULL.

@DocSize: Final size in bytes of the document stream of the document. This MUST be zero if *@SendingContent* is zero.

@DocMetaInfoSize: Size in bytes of the document's metadata info. This MUST be zero if *@DocMetaInfo* is NULL.

@DocFileFormatMetaInfo: The **DocFileFormatMetaInfo** data for the document to be stored. If there is no **DocFileFormatMetaInfo** data for this document, this parameter MUST be NULL.

@DocFileFormatMetaInfoSize: Size in bytes of the **DocFileFormatMetaInfo** data. This MUST be zero if *@DocFileFormatMetaInfo* is NULL.

@EnableMinorVersions: Specifies whether minor versions are enabled on the document. If this parameter is set to "1", minor versions MUST be enabled; otherwise, minor versions MUST NOT be enabled.

@IsModerated: Specifies whether the list (1) or document library into which the document will be stored has content approval enabled. The value MUST be one if the list (1) or document library into which the document will be stored has content approval enabled; otherwise, it MUST be zero. If the document is not to be stored in a list (1) or document library, the value MUST be zero.

@DocDirty: Specifies whether the document has dependencies such as links to other items. If this parameter is set to "1", the document has dependencies that MUST subsequently be updated.

@DocFlags: A **Document Flags** value (section [2.2.2.3](#)) that contains options for adding the document.

@DocIncomingCreatedDTM: A time stamp in UTC format that specifies when the document was created.

@DocIncomingDTM: A time stamp in UTC format that specifies the document's last modification date.

@GetWebListForNormalization: Specifies whether to return the **Site List for Normalization Result Set** (section [3.1.5.3.1](#)). If this parameter is set to "1", this procedure MUST return a list (1) of the immediate child subsites of the document's containing site in the **Site List for Normalization Result Set**. If this parameter is set to "0", the **Site List for Normalization Result Set** MUST NOT be returned. This parameter MUST NOT be NULL.

@PutFlags: A **Put Flags Type** value (section [2.2.2.7](#)) that specifies the options for adding the document.

@CreateParentDir: Specifies whether to create the parent directory for the document to be added if it does not already exist. If this parameter is set to "1", the parent directory specified by **@DocDirName** MUST be created if it does not exist. If this parameter is set to "0", this procedure MUST fail if the parent directory does not exist. This parameter MUST NOT be NULL.

@UrlIsSuggestion: Specifies whether the **@DocLeafName** provided MUST be changed to a unique value if it is not unique. If this parameter is set to "1", **@DocLeafName** MUST be updated to get a guaranteed unique URL. If this parameter is set to "0" and the URL is not unique, this procedure MUST fail. This parameter MUST NOT be NULL.

@ThicketMainFile: Specifies whether the document is a thicket main file. If this parameter is set to "1", the document is a thicket main file. If this parameter is set to "0", the document is not a thicket main file or a thicket supporting file. If this parameter is NULL, this document is a thicket supporting file.

@CharSet: An optional parameter that specifies a **code page** for the character set (2) to be associated with the document.

@ProgId: An optional parameter that specifies a preferred application to open the document. The **@ProgId** value is used to distinguish between different applications that save files with a given file extension (for example, different editors for HTML or XML files).

@AttachmentOp: An attachments flag value (section [2.2.1.2.1](#)) that specifies the security checks to be performed by **proc_AddDocument** on this document's URL, based on whether it appears to be an attachment.

@VirusVendorId: An optional parameter that specifies the identifier of the virus scanner that processed this document.

@VirusStatus: A virus status type (section [2.2.1.2.17](#)) that specifies the current virus check status of this document.

@VirusInfo: A string containing a provider-specific message returned by the virus scanner when it last processed the document. This value MUST be NULL if the document does not exist or if the document has not been processed by a virus scanner.

@VirusInfoEx: A binary value that specifies extensible virus information for this document, which is opaque to the back-end server.

@LockTimeout: An integer value that specifies the number of minutes remaining to set on a short-term lock on the document. This value MUST be a positive value if a short-term lock is requested, and this procedure MUST set the short-term lock for this period. Otherwise, this procedure MUST NOT set a short-term lock on the document.

@SharedLock: Specifies whether to establish a shared lock on the document after it is added. This parameter MUST be set to one to establish a shared lock; otherwise, it MUST be set to zero.

@Comment: An optional text check-in comment to associate with the document. This value MUST be ignored when *@Level* is set to "255".

@DocDTM: An output parameter for the time stamp of the last modification date of the document. This parameter MUST be set to the value of *@DocIncomingDTM* or to the current UTC datetime if *@DocIncomingDTM* is NULL.

@fNoQuotaOrLockCheck: Specifies whether to bypass the disk quota and disk lock check. If this parameter is set to "1", the checks are bypassed. If this parameter is set to "0", an explicit check will be made to see if the site is locked or if quota is reached.

@DocContentVerBump: An integer value used to increase the version of the content stored in the back-end database server. This value is added to the current content version number.

@BSNBump: Specifies the amount the BLOB sequence number of the document is increased by.

@StreamSchema: Specifies the stream schema of the document to be created.

@DocClientId: An optional parameter that specifies the client identifier of the document to be created.

@RequestGuid: The optional request identifier for the current request.

Return Values: This procedure returns an integer return code, which MUST be one of the values listed in the following table.

| Value | Description |
|-------|---|
| 0 | Successful execution. |
| 3 | The path specified for the document was not found. |
| 5 | Access denied error while attempting to create a directory. |
| 80 | Attempted to create a directory when the specified directory exists. The document already exists. The attempt to add the document failed. SendingContent was specified, but the document is not checked out. The attempt to add the document stream failed. |
| 212 | The disk storage was locked. |
| 1816 | Disk quota exceeded. |

The **proc_AddDocument** stored procedure returns zero to two result sets in the following order: **Site List for Normalization Result Set** (section [3.1.5.3.1](#)), **Checkout Information Result Set** (section [3.1.5.3.2](#)).

3.1.5.3.1 Site List for Normalization Result Set

The **Site List for Normalization Result Set** returns a list of URLs for the immediate child subsites of the site containing the newly added document. The **Site List for Normalization Result Set** MUST be produced when the input parameter *@GetWebListForNormalization* is set to "1" and execution has been successful up to the point of inserting the document. The **Site List for**

Normalization Result Set MUST contain one row for each subsite found. The **Site List for Normalization Result Set** is defined in the **Common Result Sets URL Result Set** (section [2.2.4.27](#)).

3.1.5.3.2 Checkout Information Result Set

The **Checkout Information Result Set** returns check-out information about the document. The **Checkout Information Result Set** MUST be returned on successful completion if either the input parameter *@Level* is set to "255", indicating that the document is checked out, or if the input parameter *@LockTimeout* is not NULL, indicating that a short-term lock was applied. The **Checkout Information Result Set** MUST contain one row.

```
tp_Login          nvarchar(255),
CheckoutDate     datetime,
{CheckoutExpires} datetime;
```

tp_Login: The login name of the principal to whom the document is checked out. If the document is currently checked in, this MUST be NULL.

CheckoutDate: A time stamp, in UTC format, indicating when this document was checked out. If the document is currently checked in, this MUST be NULL.

{CheckoutExpires}: A time stamp, in UTC format, indicating when the short-term lock for this document will expire. If the document is currently checked in or has a long-term checkout, this MUST be NULL.

3.1.5.4 proc_AddListItem

The **proc_AddListItem** stored procedure is invoked to add a list item to a list (1).

```
PROCEDURE proc_AddListItem (
    @SiteId          uniqueidentifier,
    @WebId           uniqueidentifier,
    @ListID          uniqueidentifier,
    @RowOrdinal      tinyint,
    @ItemId          int,                OUTPUT,
    @UserId          int,
    @Size           int,
    @TimeNow        datetime,
    @CopySecurityFromMasterID int      = NULL,
    @ExtraItemSize  int                = NULL,
    @CheckDiskQuota bit               = 1,
    @ItemDocType    tinyint            = 0,
    @SortTypeReversed bit             = 0,
    @BaseRowItemId  int                = NULL,
    @DocIdAdded     uniqueidentifier  = NULL,
    @RetainId       uniqueidentifier  = NULL,
    @RetainObjectIdentity bit          = 0,
    @Level          tinyint            = 1,
    @UIVersion      int                = 512,
    @ItemCountDelta int                = 1,
    @ItemName       nvarchar(255)     = NULL,
    @UseNvarcharListItemName bit       = 1,
    @ItemDirName    nvarchar(256)     = NULL   OUTPUT,
    @ItemLeafName   nvarchar(128)     = NULL   OUTPUT,
    @ServerTemplate int                = NULL,
```

```

@IsNotUserDisplayed          bit                = NULL,
@BaseType                   int                  = NULL,
@CheckSchemaVersion         int                  = NULL,
@OnRestore                  bit                  = 0,
@AddNamespace               bit                  = 0,
@tp_Ordering                varchar(512)        = NULL,
@tp_ThreadIndex             varbinary(512)      = NULL,
@tp_HasAttachment           bit                  = NULL,
@tp_ModerationStatus        int                  = 0,
@tp_IsCurrent               bit                  = 1,
@tp_ItemOrder               float               = NULL,
@tp_InstanceID              int                  = NULL,
@tp_GUID                    uniqueidentifier    = NULL,
@tp_Id                      int                  = NULL,
@tp_Author                  int                  = NULL,
@tp_Editor                  int                  = NULL,
@tp_Modified                datetime            = NULL,
@tp_Created                 datetime            = NULL,
@tp_Version                 int                  = 1,

@tp_ContentTypeID           varbinary(512)      = NULL,
@tp_CopySource              nvarchar(260)       = NULL,
@tp_HasCopyDestinations     bit                  = NULL,
@tp_WorkflowVersion         int                  = 1,
@tp_WorkflowInstanceID     uniqueidentifier    = NULL,
@nvarchar1                  nvarchar(255)      = NULL,
@MtgEventType               int                  = NULL,
@EventUID                   nvarchar(255)      = NULL,
@RecurrenceID               datetime            = NULL,
@tp_ColumnSet               xml                 = NULL,
@eventData                  varbinary(max)      = NULL,
@acl                        varbinary(max)      = NULL,
@DocClientID                varbinary(16)       = NULL,
@tp_AppAuthor               int                  = NULL,
@tp_AppEditor               int                  = NULL,
@RequestGuid                uniqueidentifier    = NULL      OUTPUT
);

```

@SiteId: The site collection identifier for the site collection containing the list (1) that the list item is being added to.

@WebId: The site identifier for the site containing the list (1) that the list item is being added to.

@ListID: The list identifier of the list (1) that the list item is being added to.

@RowOrdinal: The 0-based ordinal index of the current row to add for this list item in the set of rows representing the list item in the **AllUserData** table (section 2.2.6.2). If a list item requires multiple rows to represent it in the **AllUserData** table because it contains more defined data columns than will fit in a single row, the front-end Web server **MUST** call **proc_AddListItem** again, with the additional data using the next row value in the **@RowOrdinal** parameter. This parameter **MUST NOT** be NULL.

@ItemId: An output parameter that returns the identifier of the list item that has been added:

- If **@tp_ID** is not NULL and **@BaseRowItemId** is NULL, **proc_AddListItem** **MUST** use the value specified by **@tp_Id**.

- If *@BaseRowItemId* is not NULL, **proc_AddListItem** MUST use the value specified by *@BaseRowItemId*.
- If *@tp_ID* is NULL and *@BaseRowItemId* is NULL, **proc_AddListItem** MUST generate a new value for the list item identifier that is unique within the list (1).

@UserId: The user identifier for the current user. **proc_AddListItem** uses this for purposes of permission-checking. This value MUST refer to an existing user identifier for the specified site collection.

@Size: The size in bytes of the list item row to be added. This parameter MUST NOT be NULL.

@TimeNow: The current time, in UTC format, on the back-end database server.

@CopySecurityFromMasterID: Specifies the optional identifier of the list item to copy the security scope settings from for this list item. A list item that represents an exception to a recurrence item in a Meetings List (a list (1) with a **List Server Template** type value (section [2.2.1.2.12](#)) of 200) MUST have the same security scope settings as the master recurrence item. If this parameter is set to a master recurrence item's list item identifier and the list item to be added does not share the security scope of the master recurrence item, the new list item MUST be given a unique security scope with a copy of the security settings from the security scope of the master recurrence item. This parameter MUST only be set for list items that are exceptions to recurrence items in a Meetings List.

@ExtraItemSize: The size of the predefined SQL parameter fields in the list item row being added.

@CheckDiskQuota: A bit flag specifying whether or not **Disk Quota** is checked for the current user before adding the list item. The bit MUST be set to one for **Disk Quota** to be checked for the current user before adding the list item; otherwise, the bit MUST be set to zero.

@ItemDocType: The **Document Store Type** (section [2.2.2.4](#)) of the list item being added to the list (1).

@SortTypeReversed: Specifies whether or not the list item sorts using the behavior of folder or file types. The bit MUST be set to one for folders to sort like files; otherwise, it MUST be set to zero. It MUST be set to zero for all file type list items.

@BaseRowItemId: An optional value that specifies the list item identifier to be added if a value is not supplied by the *@tp_Id* parameter. If the *@tp_Id* parameter is NULL and this parameter is not NULL, **proc_AddListItem** MUST use this value for the list item identifier to be added.

@DocIdAdded: The optional document identifier (2) of the document to be inserted as a list item in the list (1). If *@DocIdAdded* is not NULL and the document has a document identifier (2), this parameter MUST be the existing document identifier (2). If this parameter is NULL, a new document identifier (2) MUST be generated for the list item. If this list item is being restored to the list (1) as part of an implementation-specific backup restore operation, as specified by the value of *@RetainObjectIdentity*, this parameter MUST be ignored and the value of the *@RetainId* parameter MUST be used as the document identifier (2).

@RetainId: The document identifier (2) of the document to be inserted as a list item in the list (1) if this list item is being restored to the list (1) as part of a back-up restore operation.

@RetainObjectIdentity: A bit flag specifying whether this list item is being restored to the list (1) as part of an implementation-specific backup restore operation. If *@RetainObjectIdentity* is set to one, this list item is being restored to the list (1) as part of an implementation-specific backup restore operation and MUST have the *@DocIdAdded* value specified in *@RetainId*.

@Level: The **Publishing Level Type** value (section [2.2.2.6](#)) specifying the publishing level of this list item.

@UIVersion: The UI version number for the list item.

@ItemCountDelta: The number to be added to the list item count of the containing list (1):

- For a list item added with a single call to **proc_AddListItem** or for one call for a list item with multiple rows to be added, this value **MUST** be one.
- For the other calls to **proc_AddListItem** for the additional rows to be added for the list item, this value **MUST** be zero.

@ItemName: The display name of the list item.

@UseNvarchar1ItemName: If **@ItemName** is NULL, this bit flag specifies whether to use the content of **@nvarchar1** for the display name of the list item.

@ItemDirName: An output parameter containing the directory name of the list item.

@ItemLeafName: An output parameter containing the leaf name of the list item.

@ServerTemplate: The identifier for the **List Server Template** defining the base structure of the list (1) containing this list item.

@IsNotUserDisplayed: A bit flag specifying whether the user name is not displayed with list items.

@BaseType: The **List Base Type** (section [2.2.1.2.11](#)) of the list (1) containing the list item.

@CheckSchemaVersion: Specifies an optional schema version number to compare with the list schema version number. If this parameter is not NULL, the version numbers **MUST** match for successful completion.

@OnRestore: A bit flag that specifies whether this list item is being inserted by an implementation-specific back-up restore operation.

@AddNamespace: A Boolean value specifying whether metadata is being added to the list item. This parameter **MUST NOT** be NULL.

@tp_Ordering: Specifies the threading structure for this list item in a deprecated discussion board list (1) (a list (1) with a **List Base Type** of three) as a concatenation of UTC date/time stamp values in yyyyMMddHHmmss format. For all list items in lists (1) with other **List Base Types**, this parameter **MUST** be NULL.

@tp_ThreadIndex: Specifies the list item position within a threaded discussion board list (1) (a list (1) with a **List Base Type** of three) as a binary structure. For all list items in lists (1) with other **List Base Types**, this parameter **MUST** be NULL.

@tp_HasAttachment: A bit flag that specifies whether the list item has an associated attachment.

@tp_ModerationStatus: A **Moderation Status** (section [2.2.1.2.13](#)) value specifying the current **moderation status** of this list item.

@tp_IsCurrent: A bit flag that specifies whether or not this is the current version of this publishing level of the list item.

@tp_ItemOrder: Specifies the implementation-specific order in which the list item is displayed with other list items from the same list (1). This value can be the same as other list items in the list (1).

@tp_InstanceID: Specifies a **meeting instance** identifier if the list item is associated with the particular meeting instance of a recurring meeting. For all other list items, this parameter MUST be NULL.

@tp_GUID: A GUID that uniquely identifies the list item within the **AllUserData** table.

@tp_Id: The optional **List Item Identifier** (section [2.2.1.1.6](#)) specified for this list item. If this parameter is not NULL, **proc_AddListItem** MUST use this value for the identifier of the list item to be added.

@tp_Author: The user identifier for the user who created the list item.

@tp_Editor: The user identifier for the user who last edited the list item.

@tp_Modified: A time stamp, in UTC format, that specifies when this list item was last modified.

@tp_Created: A time stamp, in UTC format, that specifies when this list item was created.

@tp_Version: Specifies the internal version number used for internal conflict detection.

@tp_ContentTypeId: Specifies the content type identifier for this list item.

@tp_CopySource: Specifies the URL used as a source for this list item. If this list item was not copied from a source list item, this value MUST be NULL.

@tp_HasCopyDestinations: A bit flag specifying whether destination locations have been set for this list item to be copied to. If this list item does not have a destination location set, this value MUST be zero.

@tp_WorkflowVersion: If the list item is part of a workflow (2), this parameter specifies the value to set denoting the state of the list item within that workflow (2). If the list item is not part of a workflow (2), this MUST be NULL.

@tp_WorkflowInstanceId: A workflow identifier that specifies the currently active workflow instance on this list item. If this list item is not part of a workflow (2), this MUST be NULL.

@nvarchar1: User-defined column in the list (1) containing a value of type nvarchar. If the column contains no data, the value MUST be NULL.

@MtgEventType: If *@ServerTemplate* corresponds to a Meeting Workspace site, this parameter specifies the type of calendar event.

@EventUID: If *@ServerTemplate* corresponds to a Meeting Workspace site, this parameter specifies the unique identifier for the meeting instance.

@RecurrenceID: If *@ServerTemplate* corresponds to a Meeting Workspace site, this parameter specifies a particular instance of a recurring meeting.

@tp_ColumnSet: The XML fragment that specifies the values of user-defined columns in the list (1). The name of each element specified in this parameter MUST be one of the columns defined in the **AllUserData** table with the SPARSE keyword.

@eventData: Contains implementation-specific event (1) data that is significant to the front-end Web server but is otherwise opaque to the back-end database server. To be stored by the BEDS for eventual writing to a log file.

@acl: The binary serialization of the **WSS ACL Format** (section [2.2.3.6](#)) ACL for the data supplied in *@eventData*. To be stored with the data.

@DocClientId: An optional parameter that specifies the client identifier of the list item to be saved. This can be NULL.

@tp_AppAuthor: The identifier of the app principal who created the list item.

@tp_AppEditor: The app principal identifier of the app principal who last edited the list item.

@RequestGuid: The optional request identifier for the current request.

Return Values: The **proc_AddListItem** stored procedure returns an integer return code, which MUST be listed in the following table.

| Value | Description |
|-------|--|
| 0 | Successful execution. |
| 2 | Postprocessing of the list item failed because a prerequisite list item was not found. |
| 3 | The directory specified for the list item does not exist. |
| 5 | The attempt to create a directory or document failed because the user does not have sufficient permissions. |
| 13 | The list item to be added is not valid. |
| 16 | Adding the list item caused updating of an existing list item to fail. |
| 33 | Cannot move directories that contain checked-out files. |
| 50 | A list item could not be deleted. |
| 80 | The document being added to the list already exists. |
| 87 | Unable to add the list item because the input parameters do not match existing list items, or an error occurred during a table update operation. |
| 138 | The list could not be moved to the specified location. |
| 160 | Could not create a unique filename. |
| 161 | A directory that spans sites cannot be moved. |
| 183 | The list item being added already exists in the list. |
| 206 | The file or directory name is too long. |
| 212 | The database for the site collection is locked. |
| 1150 | Failed to update the list. |
| 1359 | An internal error occurred while moving a list item. |
| 1638 | The current schema version of the list does not match the value in <i>@CheckSchemaVersion</i> . |
| 1816 | The site collection is over its allocated size quota. |
| 8398 | A directory could not be deleted. |

The **proc_AddListItem** stored procedure MUST return no result sets.

3.1.5.5 proc_ChangeLevelForDoc

The **proc_ChangeLevelForDoc** stored procedure is invoked to update the publishing level of a document. Depending on the settings in effect on the containing list and the permissions of the specified user making the request, this procedure also can update the document's moderation status, UI version number, and properties to reflect the change.

```
PROCEDURE proc_ChangeLevelForDoc (
    @SiteId                uniqueidentifier,
    @DirName                nvarchar(256),
    @LeafName              nvarchar(128),
    @Level                  tinyint                OUTPUT,
    @NewLevel              tinyint,
    @ModerationStatus      int,
    @EnableMinorVersions   bit,
    @Moderated             bit,
    @CreateVersion         bit,
    @UserId                int,
    @Comment               nvarchar(1023),
    @bUpdateModified       bit,
    @DoclibRowId           int                    OUTPUT,
    @DocUIVersion          int                    OUTPUT,
    @DocFlagsOut           int                    OUTPUT,
    @DocVersionOut        int                    OUTPUT,
    @RequestGuid           uniqueidentifier = NULL OUTPUT
);
```

@SiteId: The site collection identifier of the site collection containing the document.

@DirName: The directory name of the document.

@LeafName: The leaf name of the document.

@Level: A **Publishing Level Type** (section [2.2.2.6](#)) value indicating the document's current publishing **level**. This output parameter also reflects the new publishing level value for the document.

@NewLevel: A **Publishing Level Type** (section [2.2.2.6](#)) value indicating the requested publishing level for the document. If the document is currently checked out and **@NewLevel** is set to 1 (Published), then the document's level value **MUST** be changed to 1 (Published). Otherwise, the document's level value **MUST** be changed to 255 (Checked Out). If **@NewLevel** is set to 255 (Checked Out), **@EnableMinorVersions** is 0 and **@NewLevel** is set to 1 (Published), then the document's level value **MUST NOT** change, and output parameters **MUST NOT** be changed. If the document's current Level is 255 (Checked Out) and the **@NewLevel** is 2 (Draft), the document's **CheckOutUserId**, **CheckoutDate** and **CheckoutExpires** values **MUST** be set to NULL, and the document's container (document library or list) value for **tp_CheckOutUserId** **MUST** be set to NULL.

@ModerationStatus: An integer value indicating the specified document's **Moderation Status** (section [2.2.1.2.13](#)). See the Moderation Status section for a list of all valid values.

@EnableMinorVersions: A bit indicating whether minor versions are enabled within the containing list. If the list containing the specified document has minor versions enabled, then this **MUST** be set to 1; otherwise, this **MUST** be set to 0.

@Moderated: A bit indicating whether moderation is enabled on the containing list. If the list containing the specified document has moderation enabled, then this MUST be set to 1; otherwise, this MUST be set to 0.

@CreateVersion: A bit indicating whether versioning is enabled on the containing list. If the list containing the specified document has versioning enabled, then this MUST be set to 1; otherwise, this MUST be set to 0.

@UserId: A user identifier for the user requesting the document change. This value MUST refer to an existing User Identifier for the specified site collection.

@Comment: Descriptive text associated with the document on check in or publishing. When the document publishing level is updated from "Check Out" (255) to any other value, or from any value to "Publish" (1), **@Comment** can be set to a descriptive string or it can be NULL. In all other **Publishing Level Type** value transitions, this parameter MUST be NULL.

@bUpdateModified: A bit indicating if change to the last modified date and time properties of the document is requested. If **@bUpdateModified** is set to 1, then **proc_ChangeLevelForDoc** MUST update document last modified date and time properties in the store to note that the document was updated at the current time. Otherwise, the last modified date and time properties MUST be left unchanged.

@DoclibRowId: An output parameter containing the value of the **DoclibRowId** column in the **Docs View** (section [2.2.6.3](#)) for the document after the change.

@DocUIVersion: An output parameter containing the UI version of the document after the change.

@DocFlagsOut: An output parameter containing the **Doc Flags** (section [2.2.2.3](#)) of the document after the change.

@DocVersionOut: An output parameter containing the internal version number of the document after the change.

@RequestGuid: The optional request identifier for the current request.

Return Values: This procedure returns an integer return code, which MUST be included in the following table.

| Value | Description |
|-------|--|
| 0 | Successful execution. |
| 87 | The specified document could not be found, or the specified publishing level is not the current level of the specified document. |

This procedure MUST NOT return a result set.

3.1.5.6 **proc_CheckRbsInstalled**

The **proc_CheckRbsInstalled** stored procedure is invoked to test whether the back-end database server can support remote BLOB storage.

```
PROCEDURE proc_CheckRbsInstalled (  
    @RequestGuid uniqueidentifier = NULL OUTPUT  
);
```

@RequestGuid: The optional request identifier for the current request.

Return Values: The **proc_CheckRbsInstalled** stored procedure returns an integer return code, which MUST be in the following table.

| Value | Description |
|-------|--|
| 0 | The back-end database server does not support remote BLOB storage. |
| 1 | The back-end database server supports remote BLOB storage. |

The **proc_CheckRbsInstalled** stored procedure MUST NOT return any result sets.

3.1.5.7 proc_CheckoutDocument

The **proc_CheckoutDocument** stored procedure is invoked to place a short-term lock on a document, refresh, convert or release an existing short-term lock, or to check out a document. Short term locks are either of type shared or exclusive.

```
PROCEDURE proc_CheckoutDocument (
    @SiteId                uniqueidentifier,
    @WebId                 uniqueidentifier,
    @DirName               nvarchar(256),
    @LeafName              nvarchar(128),
    @Level                 tinyint,
    @EnableMinorVersions   bit,
    @IsModerated           bit,
    @UserId                int,
    @CheckoutTimeout       int,
    @RefreshLock           bit,
    @CheckoutToLocal       bit,
    @IsForceCheckout       bit,
    @IsSharedLock          bit,
    @IsConvertLock         bit,
    @DocMetaInfo           varbinary(max),
    @DocMetaInfoSize      int,
    @DocMetaInfoVersion   int,
    @GetLinkInfo           bit,
    @RequestGuid           uniqueidentifier = NULL OUTPUT
);
```

@SiteId: The site collection identifier for the site collection containing the document to be checked out, locked, or unlocked.

@WebId: The site identifier for the site containing the document.

@DirName: The directory name of the document.

@LeafName: The leaf name of the document.

@Level: A **Publishing Level Type** (section [2.2.2.6](#)) value specifying the publishing status of the document.

@EnableMinorVersions: A bit flag specifying whether the document library or list containing the document has minor version numbering enabled. If this parameter is set to "1", then minor version numbering is enabled for the document library or list; otherwise, this MUST be set to 0.

@IsModerated: A bit flag specifying whether moderation is in effect on the document. If this parameter is set to "1", then moderation is in effect on this document, which is used to implement an approval process to set the publishing level to published after the document is created or modified. This parameter MUST NOT be NULL.

@UserId: The User Identifier (section [2.2.1.1.13](#)) for the current user who is requesting a short-term lock or checking out the document. This value MUST refer to an existing user identifier for the specified site collection.

@CheckoutTimeout: Specifies the remaining time in minutes that short-term locking will be in effect for the document. A value of 0 means that the existing short-term lock MUST be released. The **@CheckoutTimeout** parameter MUST be NULL if the document is being checked out instead of having a short-term lock applied.

@RefreshLock: A bit flag specifying whether the short-term lock on the document is being refreshed. If this parameter is set to "1", then the existing short-term lock on the document MUST be refreshed for the number of minutes specified by the **@CheckoutTimeout** parameter. This parameter MUST be set to "0" to check out the document or to request a new short-term lock. This parameter MUST NOT be NULL.

@CheckoutToLocal: A bit flag specifying whether the document is to be copied to local storage on the user's client for editing. If this parameter is set to "1", then the user's client MUST make a local copy of the document stream for editing, and **proc_CheckoutDocument** MUST NOT make a checked-out version of the document in the store. This parameter MUST NOT be NULL.

@IsForceCheckout: A bit flag specifying whether the containing document library requires documents to be checked out before any changes can be made. If this parameter is set to "1", then the containing document library has 'Require Check Out' turned on. This parameter MUST NOT be NULL.

@IsSharedLock: A bit flag specifying whether the desired short term lock on the document is a shared lock or an exclusive lock. This parameter MUST be set to "1" if the desired short term lock is type shared; otherwise it MUST be set to "0".

@IsConvertLock: A bit flag specifying whether to convert an existing short term lock from one short term lock type to a different short term lock type. This parameter MUST be set to "1" to convert the type of an existing short term lock; otherwise it MUST be set to "0".

@DocMetaInfo: The metadata information for the document to be checked out. If there is no metadata information for this document, then this parameter MUST be NULL.

@DocMetaInfoSize: Size in bytes of the document's metadata info. This MUST be NULL if **@DocMetaInfo** is NULL.

@DocMetaInfoVersion: The version of the metadata information for the document to be checked out. This MUST be NULL if **@DocMetaInfo** is NULL.

@GetLinkInfo: A bit flag specifying whether the desired **Link Info Single Doc Result Set**, specified in section [3.1.5.7.1](#), is returned. This parameter MUST be set to "1" to return the **Link Info Single Doc Result Set**; otherwise it MUST be set to "0".

@RequestGuid: The optional request identifier for the current request.

Return Values: The **proc_CheckoutDocument** stored procedure returns an integer return code, which MUST be in the following table.

| Value | Description |
|-------|--|
| 0 | Successful execution. |
| 3 | File not found. A document corresponding to the specified @SiteId, @WebId, @DirName, @LeafName, and @Level parameters was not found. |
| 33 | Short-term lock error. The document cannot have a short-term lock applied because another user has the document checked out. |
| 154 | Invalid minor version value. The minor version value for the document would exceed the maximum allowed value (511) if checked out. |
| 158 | Checkout required. The document is in a document library with the "Require Check Out" option set, but the document is not being checked out. |
| 173 | Checkout error. The document cannot be checked out, because it is already checked out to or locked by another user. |
| 212 | Site collection locked. The site collection is in disk write lock. |
| 1630 | Unsupported document type. The document specified is not valid for check out; folders and sites cannot be checked out. |
| 1816 | Disk quota error. The site collection disk quota has been reached. |
| 6002 | Short-term lock error. The document cannot have a short-term lock applied because another user has a shared short-term lock on the file. A shared short-term lock is used for read operations that do not change or update data, such as a SELECT statement. |
| 6009 | Short-term lock error. The document cannot have a short-term lock applied because another user has an exclusive short-term lock on the file. An exclusive short-term lock is used for data-modification operations, such as INSERT, UPDATE, or DELETE. Such a lock ensures that multiple updates cannot be made to the same resource at the same time. |

The **proc_CheckoutDocument** stored procedure MUST return multiple result sets. Some of the result sets are returned 0 or more times depending upon conditions specified in the following sections, and all result sets that are returned will be sent in the order specified in the sections [3.1.5.7.1](#) through [3.1.5.7.4](#).

3.1.5.7.1 Link Info Single Doc Result Set

The **Link Info Single Doc Result Set** returns information about all forward links and backward links associated with the document. The **Link Info Single Doc Result Set** MUST be returned once and MUST hold one row for each forward and backward link associated with the specified document at the specified publishing level.

The **Link Info Single Doc Result Set** is defined in the Common Result Sets **Link Information Result Set** (section [2.2.4.13](#)).

3.1.5.7.2 Document Metadata Result Set

The **Document Metadata Result Set** returns the metadata for the document. The **Document Metadata Result Set** MUST be returned and MUST contain a single row corresponding to the checked-out or locked document.

The **Document Metadata Result Set** is defined in the Common Result Sets **Document Metadata Result Set** (section [2.2.4.8](#)).

3.1.5.7.3 Event Receivers Result Set

The **Event Receivers Result Set** contains information about the list item event receivers defined for this document.

The **Event Receivers Result Set** MUST only be returned if the requested document matching the `@Level` parameter exists within the site specified by the `@WebId` parameter for the current user. The **Event Receivers Result Set** MUST contain one row for each event receiver registered with an **Event Host Type** (section [2.2.1.2.5](#)) of 3 (list item) for this document.

The **Event Receivers Result Set** is defined in the Common Result Sets **Event Receivers Result Set** (section [2.2.4.11](#)).

3.1.5.7.4 Audit Mask Result Set

The **Audit Mask Result Set** returns audit configuration information for the document. The **Audit Mask Result Set** MUST be returned with one row of audit configuration information on successful execution.

The **Audit Mask Result Set** is defined in the Common Result Sets **Site Audit Mask Result Set** (section [2.2.4.22](#)).

3.1.5.8 proc_ClearLinks

The **proc_ClearLinks** stored procedure deletes all link information associated with a particular field in a list item as part of a list item or document update. All link information that matches all of the parameters and does not have associated Web Parts MUST be deleted by **proc_ClearLinks**. Link information associated with Web Parts MUST NOT be deleted by **proc_ClearLinks**.

```
PROCEDURE proc_ClearLinks(
    @SiteId                uniqueidentifier,
    @DirName               nvarchar(256),
    @LeafName              nvarchar(128),
    @Level                 tinyint,
    @FieldId               uniqueidentifier,
    @RequestGuid           uniqueidentifier = NULL OUTPUT
);
```

@SiteId: The site collection identifier of the site collection that contains the list item with the link information to be deleted.

@DirName: The directory name of the list item with the link information to be deleted.

@LeafName: The leaf name of the list item with the link information to be deleted.

@Level: The **Publishing Level Type** (section [2.2.2.6](#)) value associated with the list item with the link information to be deleted.

@FieldId: The field identifier of the field in the list item with the link information to be deleted.

@RequestGuid: The optional request identifier for the current request.

Return Values: The **proc_ClearLinks** stored procedure returns an integer return code, which MUST be 0. The **proc_ClearLinks** stored procedure MUST NOT return a result set.

3.1.5.9 proc_CreateDir

The **proc_CreateDir** stored procedure is invoked to create a directory or folder with a specified name at a specified location.

```
PROCEDURE proc_CreateDir(
    @DirSiteId                uniqueidentifier,
    @DirWebId                 uniqueidentifier,
    @DirDirName               nvarchar(256)           OUTPUT,
    @DirLeafName              nvarchar(128)          OUTPUT,
    @DirLevel                 tinyint,
    @AddMinorVersion          bit,
    @DocFlags                 int,
    @CreateDirFlags           int,
    @UserId                   int                    =NULL,
    @AppPrincipalId           int                    =NULL,
    @ProgId                   nvarchar(255)         =NULL,
    @DirMetaInfo              varbinary(max)         =NULL,
    @DirMetaInfoSize          int                    =0,
    @DirClientId              varbinary(16)          =NULL,
    @DirId                    uniqueidentifier      =NULL    OUTPUT,
    @ScopeId                  uniqueidentifier      =NULL    OUTPUT,
    @DoclibRowIdRequired      int                    =NULL,
    @ReverseSortOrder         bit                    =0,
    @ScopeIdOverride          uniqueidentifier      =NULL,
    @bAlreadyExists           bit                    =NULL    OUTPUT,
    @RequestGuid              uniqueidentifier      =NULL    OUTPUT
);
```

@DirSiteId: The site collection identifier (section [2.2.1.1.9](#)) for the site collection containing the directory to be created.

@DirWebId: The site identifier for the site containing the directory to be created.

@DirDirName: This is both an input and an output parameter. The input parameter MUST specify the store-relative form URL of the parent location in which the specified directory is to be created. The directory name of the created directory MUST be returned as the output parameter value.

@DirLeafName: This is both an input and an output parameter. The input parameter MUST specify the name of the directory to be created in the parent location specified by the **@DirDirName** parameter. The leaf name of the created directory MUST be returned as the output parameter value.

@DirLevel: A **Publishing Level Type** value (section [2.2.2.6](#)) specifying the publishing status of the directory to be created. This value MUST be one (Published) if the directory is not being created in a list (1) or document library. If this parameter is two, specifying that the list item is to be created as a draft, the **@UserId** value MUST be set as the draft owner for the created directory.

@AddMinorVersion: If this parameter has a value of one, **proc_CreateDir** MUST set the major version number of the created directory to zero and the minor version number to one. If this parameter has a value of zero, **proc_CreateDir** MUST set the major version number of the created directory to one and the minor version number to zero. This parameter MUST NOT be NULL.

@DocFlags: A **Doc Flags** value (section [2.2.2.3](#)) specifying metadata about the directory to be created. If the **@DocFlags** value has the 0x00002000 bit set (specifying a custom ordering of content types), this bit flag MUST be ignored and MUST NOT be included in the metadata associated with the created directory.

@CreateDirFlags: A 4-byte unsigned integer bit mask containing options used while creating the directory. The value **MUST** be zero, with none of the bits set, or bits **MUST** be set as follows.

| Value | Description |
|------------|--|
| 0x00000007 | These three bits contain an Attachment Flag value (section 2.2.1.2.1). |
| 0x00000008 | Return an access denied error if the specified directory already exists. |
| 0x00000010 | Do not promote the directory to a document library. |
| 0x00000020 | The directory contains a thicket. |
| 0x00000380 | These three bits contain a Moderation Status value (section 2.2.1.2.13). |
| 0xFFFFFC40 | These values are currently unused and MUST be ignored. |

@UserId: The **User Identifier** (section [2.2.1.1.13](#)) for the current user who is directly or indirectly requesting the directory creation. If this parameter is not NULL, it **MUST** be used by **proc_CreateDir** for permission checking and setting ownership of the created directory. If this parameter is NULL, the ownership of the created directory **MUST** be set from the parent.

@AppPrincipalId: The app principal identifier of the app (1) that is requesting this operation. If the operation was not requested by an app (1) then it **MUST** be set to 0.

@ProgId: An optional parameter that specifies a preferred application to open the directory. The **@ProgId** value is used to distinguish between different applications that save files with a given file extension. This can be NULL.

@DirMetaInfo: The metadata information for the directory to be created. This can be NULL.

@DirMetaInfoSize: Size, in bytes, of the directory's metadata info. This **MUST** be zero if **@DirMetaInfo** is NULL.

@DirClientId: An optional parameter that specifies the client identifier of the directory to be created. This can be NULL.

@DirId: The identifier for the created directory. This is both an input and output parameter. If this parameter is passed in to **proc_CreateDir** with a non-NULL value, this value **MUST** be unique in the back-end database server and **MUST** be used as the document identifier (2) for the directory to be created. If this parameter is passed in with a NULL value, a new uniqueidentifier value **MUST** be generated for the directory. If **proc_CreateDir** creates a new directory, it **MUST** return the document identifier (2) for the created directory in the output parameter upon successful completion. If **proc_CreateDir** does not create a new directory (for example, if the directory already exists), this output parameter **MUST** be ignored.

@ScopeId: An output parameter that **MUST** contain the non-NULL value specified for **@ScopeIdOverride** or if a NULL value is specified for **@ScopeIdOverride**, the **Scope Identifier** (section [2.2.1.1.8](#)) of the parent directory. This identifies the specific ACL to use for calculating the permission settings on the created directory.

@DoclibRowIdRequired: Specifies the **List Item Identifier** (section [2.2.1.1.6](#)) to be used for this directory if created within a document library. If this parameter is not NULL and the directory to be created is within a document library, **proc_CreateDir** **MUST** set this as the list item identifier for the created directory. This parameter **MUST** be NULL for directories that are not created within a document library.

@ReverseSortOrder: Specifies whether the directory sorts using the behavior of the file or directory type. The bit MUST be set to "1" for directories to sort like files; otherwise, it MUST be set to "0".

@ScopeIdOverride: Specifies the scope to use for the directory to be created. If this parameter is not NULL, it MUST be set as the **Scope Identifier** (section 2.2.1.1.8) for the directory. Otherwise, the **Scope Identifier** of the parent directory MUST be used. The scope set for the created directory MUST be returned in the **@ScopeId** output parameter.

@bAlreadyExists: An output parameter containing a bit flag set to zero if the directory did not already exist and set to one if the directory already existed.

@RequestGuid: The optional request identifier for the current request.

Return Values: The **proc_CreateDir** stored procedure MUST return an integer return code that MUST be in the following table.

| Value | Description |
|-------|--|
| 0 | Successful execution. |
| 3 | The parent directory was not found. |
| 5 | The current user does not have sufficient permissions to create the directory at the specified location. |
| 13 | The list item to be added is not valid. |
| 16 | Adding the list item caused updating of an existing list item to fail. |
| 80 | The specified directory already exists. |
| 87 | Unable to add the list item because the input parameters do not match existing list items, or an error occurred during a table update operation. |
| 206 | The file or directory name is too long. |
| 212 | The site collection is locked. |
| 1150 | Failed to update the list (1). |
| 1816 | There is not enough database quota for the current user to complete the operation. |

The **proc_CreateDir** stored procedure MUST NOT return any result sets.

3.1.5.10 proc_DeleteAllDocumentVersions

The **proc_DeleteAllDocumentVersions** stored procedure is invoked to delete either the draft versions or older published versions of a document and optionally place them in the recycle bin.

```

PROCEDURE proc_DeleteAllDocumentVersions(
    @DocSiteId                uniqueidentifier,
    @DocDirName                nvarchar(256),
    @DocLeafName               nvarchar(128),
    @UserId                    int,

    @AppPrincipalId           int,
    @DeleteOp                  int,
    @Level                     tinyint,

```

```

        @RequestGuid                uniqueidentifier = NULL          OUTPUT
    );

```

@DocSiteId: The site collection identifier (section [2.2.1.1.9](#)) of the site collection containing the document whose specified versions are being deleted.

@DocDirName: The directory name of the document whose specified versions will be deleted. If there is no forward slash in the directory name, then the value MUST be an empty string.

@DocLeafName: The leaf name of the document whose specified versions will be deleted.

@UserId: The user identifier (section [2.2.1.1.13](#)) of the current user requesting the deletion. This value MUST refer to an existing user identifier for the site collection specified by **@DocSiteId**.

@AppPrincipalId: The app principal identifier of the app (1) that is requesting this operation. If the request is not made by an app (1) then it MUST be set to 0.

@DeleteOp: A parameter specifying the delete options. The value MUST be listed in the following table.

| Value | Description |
|-------|--|
| 3 | The deleted document versions MUST NOT be placed in the recycle bin (nonrecoverable delete). |
| 4 | The deleted document versions MUST be placed in the recycle bin (recoverable delete). |

@Level: A **Publishing Level Type** (section [2.2.2.6](#)) value specifying which versions of the document are to be deleted. The value MUST be listed in the following table.

| Value | Description |
|-------|--|
| 1 | All versions of the document MUST be deleted, excluding the current version and the current published version. If the current version and the current published version are the same, then only one version will remain. |
| 2 | All draft versions of the document MUST be deleted, excluding the current version. |

@RequestGuid: The optional request identifier for the current request.

Return Values: The **proc_DeleteAllDocumentVersions** stored procedure returns an integer return code that MUST be listed in the following table.

| Value | Description |
|-------|---|
| 0 | Successful execution. |
| 2 | The document specified cannot be found in the site collection. |
| 1359 | Invalid Parameter: @DeleteOp does not contain a valid value. |

The **proc_DeleteAllDocumentVersions** stored procedure MUST NOT return any result sets.

3.1.5.11 proc_DeleteDocBuildDependencySet

The **proc_DeleteDocBuildDependencySet** stored procedure is invoked to delete a build dependency set for a specified document.

```
PROCEDURE proc_DeleteDocBuildDependencySet (
    @DocSiteId          uniqueidentifier,
    @DocDirName         nvarchar(256),
    @DocLeafName        nvarchar(128),
    @Level              tinyint
    @RequestGuid        uniqueidentifier = NULL      OUTPUT
);
```

@DocSiteId: The **Site Collection Identifier** (section [2.2.1.1.9](#)) for a site collection containing the document.

@DocDirName: The directory name containing the document. If there is no forward slash in the directory name, the value MUST be an empty string.

@DocLeafName: The leaf name containing the document.

@Level: The **Publishing Level Type** (section [2.2.2.6](#)) value of the document.

@RequestGuid: The optional request identifier for the current request.

Return Values: The **proc_DeleteDocBuildDependencySet** stored procedure MUST return an integer return code of 0.

The **proc_DeleteDocBuildDependencySet** stored procedure MUST NOT return a result set.

3.1.5.12 proc_DeleteDocumentVersion

The **proc_DeleteDocumentVersion** stored procedure is invoked to delete a document version and optionally place it in the recycle bin. A current version (whether published or draft) cannot be deleted. A current version is either the current published version or the current draft version of the document.

```
PROCEDURE proc_DeleteDocumentVersion (
    @DocSiteId          uniqueidentifier,
    @DocDirName         nvarchar(256),
    @DocLeafName        nvarchar(128),
    @DocVersion         int,
    @UserId             int,
    @AppPrincipalId     int,
    @DeleteOp           int
    @RequestGuid        uniqueidentifier = NULL      OUTPUT
);
```

@DocSiteId: The site collection identifier (section [2.2.1.1.9](#)) of the site collection containing the document whose specified version is being deleted.

@DocDirName: The directory name of the document to delete. If there is no forward slash in the directory name, then the value MUST be an empty string.

@DocLeafName: The leaf name of the document to delete.

@DocVersion: The version of the document to delete. This value MUST NOT be a current version.

@UserId: The User Identifier (section 2.2.1.1.13) of the current user requesting the deletion. This value MUST refer to an existing user identifier for the specified site collection.

@AppPrincipalId: The app principal identifier of the app (1) requesting the deletion. If the request is not made by an app (1) then it MUST be set to 0.

@DeleteOp: A value determining delete options. The value MUST be listed in the following table.

| Value | Description |
|-------|--|
| 3 | The deleted document version MUST NOT be placed in the recycle bin (non-recoverable delete). |
| 4 | The deleted document version MUST be placed in the recycle bin (recoverable delete). |

@RequestGuid: The optional request identifier for the current request.

Return Values: The **proc_DeleteDocumentVersion** stored procedure returns an integer return code that MUST be in the following table.

| Value | Description |
|-------|--|
| 0 | Successful execution. |
| 2 | The document version specified by <i>@DocSiteId</i> , <i>@DocDirName</i> , <i>@DocLeafName</i> and <i>@DocVersion</i> cannot be found. |
| 186 | Invalid Parameter: An invalid version was specified. The value specified in <i>@DocVersion</i> is a current version. |

The **proc_DeleteDocumentVersion** stored procedure MUST NOT return any result sets.

3.1.5.13 proc_DeleteUrl

The **proc_DeleteUrl** stored procedure is invoked to delete a document. **proc_DeleteUrl** accepts documents of all types except sites or attachment folders.

```

PROCEDURE proc_DeleteUrl (
    @WebSiteId                uniqueidentifier,
    @WebId                    uniqueidentifier,
    @Url                      nvarchar(260),
    @UserId                   int,
    @AppPrincipalId           int,
    @LogChange                bit                =1,
    @ListDeletedUrls          bit                =1,
    @ListDeletedAliases       bit                =0,
    @AttachmentsFlag          tinyint           =0,
    @AttachmentOp             int                =3,
    @IgnoreCheckedOutFiles    bit                =0,
    @IgnoreLookupRelationshipsCheck bit        =0,
    @DeleteOp                 int                =3,
    @ThresholdRowCount        int                =0,
    @QueryAuditFlags          bit                =0,
    @FailedUrl                nvarchar(260)     =NULL      OUTPUT,
    @DeleteTransactionId      uniqueidentifier  =
        '00000000-0000-0000-0000-000000000000' OUTPUT,

```

```

@eventData          varbinary(max)      =NULL,
@acl                varbinary(max)      =NULL,
@IsCascadeDeleteOperation bit              =0,
@IsCascadeParent    bit              =0,
@ChildDeleteTransactionId varbinary(16)      =NULL      OUTPUT,
@RequestGuid        uniqueidentifier =NULL      OUTPUT
);

```

@WebSiteId: The site collection identifier (section [2.2.1.1.9](#)) of the site collection containing the document.

@WebId: The site identifier (section [2.2.1.1.11](#)) of the site containing the document.

@Url: The store-relative form URL of the document.

@UserId: The user identifier (section [2.2.1.1.13](#)) for the current user requesting the operation. This parameter is used by **proc_DeleteUrl** for purposes of permission-checking. This value MUST refer to an existing user identifier for the specified site collection.

@AppPrincipalId: The app principal identifier of the app (1) requesting this operation. If this operation was not requested by an app (1) then it MUST be set to 0.

@LogChange: This parameter is reserved for internal use and MUST be the default value.

@ListDeletedUrls: If this bit is set to 1, then the result set information about the deleted documents is requested. See the **Deleted Documents Result Set** (section [3.1.5.13.1](#)).

@ListDeletedAliases: If this bit is set to 1, then the result set information about deleted lists that had configured e-mail addresses is requested. See the **Deleted Aliased Lists Result Set** (section [3.1.5.13.2](#)).

@AttachmentsFlag: An **Attachments Flag** (section [2.2.1.2.1](#)) describing the document specified by **@Url**.

@AttachmentOp: This parameter specifies whether or not the attachment folder record in the store MUST be updated to reflect whether or not it has any attachments remaining, and which metadata in the store for the folder MUST be refreshed, as follows.

| Value | Description |
|-------|---|
| 0 | No updates. |
| 1 | The attachment folder record in the store MUST be updated to reflect whether it has any attachments remaining. |
| 2 | The attachment folder record in the store MUST be updated, and the internal version number of the folder MUST be incremented. |
| 3 | The attachment folder record in the store MUST be updated, and the last modified date and time of the folder MUST be refreshed. |

@IgnoreCheckedOutFiles: This parameter is reserved for internal use and MUST be the default value.

@IgnoreLookupRelationshipsCheck: This parameter is reserved for internal use and MUST be the default value.

@DeleteOp: This value defines the type of delete operation to attempt. If no value is specified, then a default value of 3 is used. Otherwise, *@DeleteOp* MUST be one of the values listed in the following table.

| Value | Description |
|-------|--|
| 3 | Delete the item without placing the deleted item into the recycle bin. |
| 4 | Delete the item and place the deleted item into the recycle bin. |

@ThresholdRowCount: If this value is not 0, then the stored procedure MUST not proceed with the delete operation if the number of document rows deleted by the operation exceeds the value of this parameter.

@QueryAuditFlags: This parameter is set to 1 to specify that an **audit entry** MUST be created for the delete operation.

@FailedUrl: An output parameter indicating the store-relative form URL at which the delete operation failed. This parameter MUST be set to NULL if the deletion was successful.

@DeleteTransactionId: This parameter is a value which is used to identify all files and items that are deleted as part of a single SQL transaction. The first call to **proc_DeleteUrl** within the SQL transaction MUST pass NULL. The implementation assigns a new delete transaction ID and returns it as output. On output, this parameter MUST return either an all-zero GUID, indicating that the item was not placed into the recycle bin, or a valid transaction ID generated by the implementation. All subsequent calls to **proc_DeleteUrl** within the SQL transaction MUST pass the value returned by the first call.

@eventData: This parameter is reserved for internal use and MUST be the default value.

@acl: This parameter is reserved for internal use and MUST be the default value.

@IsCascadeDeleteOperation: This parameter is reserved for internal use and MUST be the default value.

@IsCascadeParent: This parameter is reserved for internal use and MUST be the default value.

@ChildDeleteTransactionId: This parameter is reserved for internal use and MUST be the default value.

@RequestGuid: The optional request identifier for the current request.

Return Values: The **proc_DeleteUrl** stored procedure returns an integer return code, which MUST be listed in the following table.

| Value | Description |
|-------|--|
| 0 | Successful execution. |
| 3 | The specified URL was not found. |
| 5 | The user is not authorized to make this change. |
| 33 | Cannot delete a folder containing checked-out or locked files. |
| 36 | The number of rows deleted by the operation exceeds the threshold. |

| Value | Description |
|-------|--|
| 50 | Cannot delete a site or an attachments folder. |
| 51 | Cannot delete a forms folder. |
| 138 | Cannot delete a URL containing lists. |
| 161 | Cannot delete a URL that contains sites. |
| 206 | The URL is too long. |
| 1150 | A concurrency violation or unknown error occurred. |
| 1359 | Internal error, or bad parameter specified (Attachments Flag specifies an attachment file, but the URL to be deleted is a file in a document library). |
| 4335 | Cannot delete a URL because of a lookup relationship referential integrity constraint. |
| 8398 | There was an error deleting a list. At least one list could not be deleted. |

The **proc_DeleteUrl** stored procedure MUST return zero, one, or two result sets in the order shown.

3.1.5.13.1 Deleted Documents Result Set

The **Deleted Documents Result Set** contains information about the deleted documents. It MUST be returned on successful completion when *@ListDeletedUrls* is set to 1.

If the **Deleted Documents Result Set** is returned, it MUST contain one row for each document deleted.

If the document specified by *@Url* has a **Document Store Type** (section [2.2.2.4](#)) of 0 (File), then the columns in the **Deleted Documents Result Set** MUST NOT be named; else they are named as follows:

```
{Url}          nvarchar(260),
Type          tinyint;
```

Url: The store-relative form URL of the deleted document.

Type: The **Document Store Type** of the deleted document.

3.1.5.13.2 Deleted Aliased Lists Result Set

The **Deleted Aliased Lists Result Set** contains information about all deleted lists that were configured with an e-mail address. Such lists provide implementation-specific e-mail integration features. The **Deleted Aliased Lists Result Set** MUST be returned only when *@ListDeletedAliases* is set to 1 and the document specified by *@Url* does not have a **Document Store Type** (section [2.2.2.4](#)) of 0 (File).

If the **Deleted Aliased Lists Result Set** is returned, there MUST be one row returned for each deleted alias list.

```
{WebSiteId}    uniqueidentifier,
tp_WebId       uniqueidentifier,
```

```
tp_Id                               uniqueidentifier;
```

{WebServiceId}: The site collection identifier of the site collection containing the deleted list.

tp_WebId: The site identifier of the site containing the list.

tp_Id: The list identifier of the deleted list.

3.1.5.13.3 Empty Deleted Aliased Lists Result Set

The **Empty Deleted Aliased Lists Result Set** MUST be returned only if *@ListDeletedAliases* is set to 1 and the document specified by *@Url* has a **Document Store Type** (section 2.2.2.4) of 0 (File). Deletion of a file does not cause the deletion of lists, and the **Empty Deleted Aliased Lists Result Set** is returned to indicate that the input parameter *@ListDeletedAliases* cannot be satisfied.

The **Empty Deleted Aliased Lists Result Set** has zero rows with a schema of two unnamed columns.

3.1.5.14 proc_DisableRbs

The **proc_DisableRbs** stored procedure is invoked to prepare the back-end database server to stop storing content in remote BLOB storage, and reclaim any back-end database server resources allocated with **proc_EnableRbs**.

```
PROCEDURE proc_DisableRbs (  
  @RequestGuid uniqueidentifier = null OUTPUT,  
  );
```

@RequestGuid: The optional request identifier for the current request

Return values: The **proc_DisableRbs** stored procedure returns an integer return code, which MUST be in the following table.

| Value | Description |
|-------|---|
| 1060 | The back-end database server does not support remote BLOB storage. |
| 108 | The back-end database server cannot disable remote BLOB storage because content is still stored in remote BLOB storage. |
| 0 | Successful execution. |

The **proc_DisableRbs** stored procedure MUST NOT return any result sets.

3.1.5.15 proc_DirtyDependents

The **proc_DirtyDependents** stored procedure is invoked to mark all items that depend on a given document, configuration setting, navigation structure, or usage statistic as "dirty", so that subsequent action can be taken to update them as necessary. In this context, a "dependent" item is an item that requires an update to its metadata when another item is modified. **proc_DirtyDependents** follows the full dependency chain until all dependent items are marked.

```
PROCEDURE proc_DirtyDependents(  
  @SiteId                               uniqueidentifier,
```



```

@DepType          tinyint,
@DepDesc          nvarchar(270),
@DepDescLike     nvarchar(260) =NULL,
@RequestGuid     uniqueidentifier =NULL OUTPUT
);

```

@SiteId: The site collection identifier for a site collection that contains the items with dependencies.

@DepType: The dependency type. The following values are valid.

| Value | Description |
|-------|--|
| 1 | Document dependency. This updates items dependent on the specified document. The <i>@DepDesc</i> parameter is the store-relative form URL of the document that has changed. |
| 3 | Configuration dependency. This updates items dependent on changes to system configuration metadata, as specified in [MC-FPSEWM] section 2.2.2.3. The <i>@DepDesc</i> parameter is the metakey for the metadata that has changed. |
| 4 | Navigation dependency. This updates items dependent on changes to navigation structures. The <i>@DepDesc</i> parameter contains the Web-Navigation-URL, as specified in [MC-FPSEWM] section 2.2.2.2.34, for a navigation structure node. |
| 7 | Usage dependency. This updates items dependent on changes to site usage statistics. The <i>@DepDesc</i> parameter is the store-relative form URL of the site. |

@DepDesc: This specifies the dependency description parameter, which varies according to the value of *@DepType*, as described in the preceding table.

@DepDescLike: This parameter is unused and MUST be ignored.

@RequestGuid: The optional request identifier for the current request.

Return Values: The **proc_DirtyDependents** stored procedure MUST return value 0.

The **proc_DirtyDependents** stored procedure returns no result sets.

3.1.5.16 proc_EnableRbs

The **proc_EnableRbs** stored procedure is invoked to prepare the back-end database server to store content in remote BLOB storage.

```

PROCEDURE proc_EnableRbs (
@RequestGuid uniqueidentifier = null OUTPUT,
);

```

@RequestGuid: The optional request identifier for the current request.

Return values: The **proc_EnableRbs** stored procedure returns an integer return code, which MUST be in the following table.

| Value | Description |
|-------|--|
| 1060 | The back-end database server does not support remote BLOB storage. |
| 0 | Successful execution. |

The **proc_EnableRbs** stored procedure MUST NOT return any result sets.

3.1.5.17 proc_EnumLists

The **proc_EnumLists** stored procedure returns a list of the lists (1) in a site (2), along with their associated metadata.

```

PROCEDURE proc_EnumLists (
    @SiteId                uniqueidentifier,
    @WebId                 uniqueidentifier,
    @Collation             nvarchar(48),
    @BaseType              int                =NULL,
    @BaseType2             int                =NULL,
    @BaseType3             int                =NULL,
    @BaseType4             int                =NULL,
    @ServerTemplate        int                =NULL,
    @FMobileDefaultViewUrl bit              =NULL,
    @FRootFolder           bit              =NULL,
    @ListFlags             int                =NULL,
    @FAclInfo              int                =NULL,
    @Scopes                varbinary(max)    =NULL,
    @FRecycleBinInfo       bit              =NULL,
    @UserId                int                =NULL,
    @FGP                   bit              =NULL,
    @RequestGuid           uniqueidentifier  =NULL OUTPUT
);

```

@SiteId: The site collection identifier of the site collection.

@WebId: The site identifier for the site (2) containing the requested lists (1).

@Collation: This parameter determines the sort order in which the lists are returned in the **List Information Result Set** (section [3.1.5.17.1](#)) (based on the `tp_Title` column). This MUST be the **Windows collation name** of one of the valid **Collation Order Enumeration** (section [2.2.1.2.4](#)) values, with the case-insensitive and accent-sensitive flags set. For example, the collation order "Latin1_General" with the case-insensitive and accent-sensitive flags set, has a Windows collation name of "Latin1_General_CI_AS".

@BaseType: A parameter that restricts the returned lists by **List Base Type** (section [2.2.1.2.11](#)). If this parameter is set one of the **List Base Type** values, the lists returned MUST be restricted to lists with this **List Base Type** and with the **List Base Types** specified by **@BaseType2**, **@BaseType3**, and **@BaseType4**, if any. If this parameter is set to "-1" or NULL, then the lists matching any **List Base Type** value will be returned, and parameters **@BaseType2**, **@BaseType3**, and **@BaseType4** MUST be ignored by this procedure.

@BaseType2, **@BaseType3**, **@BaseType4:** Additional parameters used to specify additional **List Base Types** for lists returned, depending on the value of the **@BaseType** parameter. If any of these additional parameters are set to "-1" or NULL, then the additional parameter MUST be ignored.

@ServerTemplate: The identifier for the **List Server Template** (section [2.2.1.2.12](#)) that defines the base structure of the lists to be returned. If this parameter is set to one of the **List Server Template** values, then those lists returned **MUST** be restricted to those whose **List Server Template** value matches **@ServerTemplate**. If this parameter is set to "-1" or NULL, then lists matching any **List Server Template** will be returned.

@FMobileDefaultViewUrl: A bit specifying whether information about the mobile default view URL is requested. If this parameter is set to 1, then the information **MUST** be returned in the **tp_MobileDefaultViewUrl** column in the **List Information Result Set**. Otherwise, the **tp_MobileDefaultViewUrl** column **MUST** be returned with NULL values.

@FRootFolder: A bit specifying whether information about the root folder URL is requested. If this parameter is set to 1, then the information **MUST** be returned in the **tp_RootFolder** column in the **List Information Result Set**. Otherwise, the **tp_RootFolder** column **MUST** be returned with NULL values.

@ListFlags: A **List Flags** (section [2.2.2.5](#)) value restricting the data returned by the **List Information Result Set**. If this parameter is not NULL, then the stored procedure **MUST** only return data in the **List Information Result Set** for lists with a **tp_Flags** value exactly matching the **@ListFlags** value. Otherwise, this parameter **MUST** be ignored.

@FAclInfo: A flag specifying whether ACL information is requested. If this parameter is set to 1, then the ACL information **MUST** be returned in the **tp_ACL** column in the **List Information Result Set**. Otherwise, the **tp_ACL** column **MUST** be returned with NULL values.

@Scopes: A concatenation of one or more Scope Identifiers (section [2.2.1.1.8](#)), represented as 16-byte binary strings with no delimiters, each specifying a scope identifier. If this parameter is not NULL, then this specifies that the stored procedure **MUST** only return data in the **List Information Result Set** for lists matching those scopes specified by this parameter. Otherwise, this parameter **MUST** be ignored.

@FRecycleBinInfo: A bit specifying whether to return information about the contents of the implementation-specific Recycle Bin. If this parameter is set to 1, then the **Recycle Bin Information Result Set** (section [3.1.5.17.2](#)) **MUST** be returned. Otherwise, the **NULL Result Set** (section [3.1.5.17.3](#)) **MUST** be returned.

@UserId: A User Identifier (section [2.2.1.1.13](#)) that specifies the information to return in the **Recycle Bin Information Result Set**. If the **@FRecycleBinInfo** parameter is set to 1, then the stored procedure **MUST** only return data in the **Recycle Bin Information Result Set**. Otherwise, this parameter **MUST** be ignored.

@FGP: A bit restricting the data returned by the **List Information Result Set**. If this parameter is set to 1, then the stored procedure **MUST** only return data in the **List Information Result Set** for lists that are using per-list permissions. Otherwise, this parameter **MUST** be ignored.

@RequestGuid: The optional request identifier for the current request.

Return Values: The **proc_EnumLists** stored procedure returns an integer return code, which **MUST** be 0. This stored procedure **MUST** return two result sets in the order specified in the following sections.

3.1.5.17.1 List Information Result Set

The **List Information Result Set** returns information about lists (1) contained in the specified site (2). This result set **MUST** be returned and **MUST** contain zero or more rows, one for each list that matches the specified input parameters.

| | |
|------------------------------------|-------------------|
| tp_DocTemplateUrl | nvarchar(386), |
| tp_DefaultViewUrl | nvarchar(386), |
| tp_MobileDefaultViewUrl | nvarchar(256), |
| tp_Id | uniqueidentifier, |
| tp_Title | nvarchar(255), |
| tp_Description | nvarchar(max), |
| tp_ImageUrl | nvarchar(255), |
| tp_Name | nvarchar(38), |
| tp_BaseType | int, |
| tp_FeatureId | uniqueidentifier, |
| tp_ServerTemplate | int, |
| tp_Created | datetime, |
| tp_Modified | datetime, |
| tp_LastDeleted | datetime, |
| tp_Version | int, |
| tp_Direction | int, |
| tp_ThumbnailSize | int, |
| tp_WebImageWidth | int, |
| tp_WebImageHeight | int, |
| tp_Flags | bigint, |
| tp_ItemCount | int, |
| tp_AnonymousPermMask | bigint, |
| tp_RootFolder | nvarchar(260), |
| tp_ReadSecurity | int, |
| tp_WriteSecurity | int, |
| tp_Author | int, |
| tp_EventSinkAssembly | nvarchar(255), |
| tp_EventSinkClass | nvarchar(255), |
| tp_EventSinkData | nvarchar(255), |
| tp_EmailAlias | nvarchar(128), |
| tp_WebFullUrl | nvarchar(256), |
| tp_WebId | uniqueidentifier, |
| tp_SendtoLocation | nvarchar(512), |
| tp_ScopeId | uniqueidentifier, |
| {tp_MaxMajorVersionCount} | int, |
| {tp_MaxMajorwithMinorVersionCount} | int, |
| tp_DefaultWorkflowId | uniqueidentifier, |
| tp_HasInternalFGP | bit, |
| tp_NoThrottleListOperations | bit, |
| HasRelatedLists | bit, |
| Followable | bit, |
| tp_ValidationFormula | nvarchar(1024), |
| tp_ValidationMessage | nvarchar(1024), |
| TitleResource | nvarchar(256), |
| DescriptionResource | nvarchar(256), |
| tp_ACL | varbinary(max); |

tp_DocTemplateUrl: Contains the **store-relative URL** of the document template (2) associated with the list, if any, or NULL if none.

tp_DefaultViewUrl: Contains the URL in store-relative form default view of the list. This value MUST NOT be NULL.

tp_MobileDefaultViewUrl: When *@FMobileDefaultViewUrl* is set to "1", this contains the URL in store-relative form of the default view for mobile devices, if any, or NULL if none has been set. Otherwise, this MUST be NULL.

tp_Id: Contains the List Identifier (section [2.2.1.1.5](#)) for the list.

tp_Title: Contains the display name (a short user-provided text description) to identify the list.

tp_Description: Contains user-provided text describing the list.

tp_ImageUrl: Contains the URL in store-relative form holding an image associated with the list.

tp_Name: Contains a string representation of the **tp_Id** GUID delimited by braces ({}).

tp_BaseType: Contains the **List Base Type** (section [2.2.1.2.11](#)) value from which the list is derived.

tp_FeatureId: Contains a Feature Identifier (section [2.2.1.1.4](#)) for a feature associated with the list.

tp_ServerTemplate: Contains the value of the of the **list template** that defines the base structure of the list. This value can either be in the **List Server Template** (section [2.2.1.2.12](#)) enumeration or can be a custom value as defined in the disk-based template of the list. A custom list template value **MUST** be unique and **MUST** be greater than 10000.

tp_Created: Contains the time in Coordinated Universal Time (UTC), specifying when the list was created.

tp_Modified: Contains the time in UTC, specifying when the list was last modified.

tp_LastDeleted: Contains a time stamp, in UTC format, specifying when a list item was last deleted from the list. If no list item has been deleted, contains the value of **tp_Created**.

tp_Version: Contains an implementation-specific, internal version counter used in tracking modifications to the list's settings.

tp_Direction: Contains a value specifying the direction of text flow for front-end Web server elements. Valid values are in the following table.

| Value | Description |
|-------|-------------------------------------|
| 0 | No explicit direction is specified. |
| 1 | Text flow is left to right. |
| 2 | Text flow is right to left. |

tp_ThumbnailSize: The width, in pixels, specified for use when creating thumbnail images of list items within this list. This value **MUST** be NULL for lists that do not have a **List Server Template** value of 109. Thumbnails images are generated by the front-end Web server for documents and they are implementation-specific capabilities.

tp_WebImageWidth: The width, in pixels, specified for use when creating images of list items within this list. This value **MUST** be NULL for lists that do not have a **List Server Template** value of 109.

tp_WebImageHeight: The height, in pixels, specified for use when creating images of list items within this list. This value **MUST** be NULL for lists that do not have a **List Server Template** value of 109.

tp_Flags: Contains a **List Flags** (section [2.2.2.5](#)) value describing list properties.

tp_ItemCount: Contains a count of list items in the list.

tp_AnonymousPermMask: Contains the **WSS Rights Mask** (section [2.2.2.15](#)) that applies to an anonymous user for the list.

tp_RootFolder: When the *@FRootFolder* parameter is set to "1", this contains the URL in store-relative form of the root folder of the list. Otherwise, this MUST be NULL.

tp_ReadSecurity: Contains a value identifying the **security policy** for read-only mode for list items. If this value is set to 1, then users with read-only mode permissions can read all list items. Otherwise, users with read-only mode permissions can read only those list items they create.

tp_WriteSecurity: Contains a value specifying the security policy in use for write access to list items. Valid values are in the following table.

| Value | Description |
|-------|---|
| 1 | Users with write permissions have write access to all list items. |
| 2 | Users with write permissions have write access to those list items they create. |
| 4 | Users have no write access to any list items. |

tp_Author: Contains the User Identifier (section [2.2.1.1.13](#)) of the user who created the list.

tp_EventSinkAssembly: Contains the **assembly name** of the event sink handler if an event sink handler is registered for the list or NULL if none exists.

tp_EventSinkClass: Contains the assembly class name of the event sink handler if an event sink handler is registered for the list or NULL if none exists.

tp_EventSinkData: Contains string data specific to the implementation of the event sink associated with this list, or NULL if none exists.

tp_EmailAlias: Contains the e-mail address of the list. This alias is used to allow files to be sent directly to the list through an implementation-specific e-mail handling feature. Can be NULL if the list is not an **e-mail enabled list**.

tp_WebFullUrl: Contains the store-relative URL of the site that contains the list.

tp_WebId: Contains the Site Identifier (section [2.2.1.1.11](#)) of the site that contains the list.

tp_SendToLocation: Contains an implementation-specific string of the URL used to copy list items to alternative locations. This parameter can be NULL.

tp_ScopeId: Contains the scope identifier for the list.

{tp_MaxMajorVersionCount}: Contains the number of major versions that will be retained for this document if versioning is enabled.

{tp_MaxMajorwithMinorVersionCount}: Contains the number of major versions that will have their associated minor versions retained for this document if versioning is enabled.

tp_DefaultWorkflowId: Contains the Workflow Identifier (section [2.2.1.1.16](#)) of the default workflow (2) associated with the list or NULL if none exists.

tp_HasInternalFGP: This flag is set to 1 if there have ever been list items that have had per-list permissions applied.

tp_NoThrottleListOperations: If this list is exempt from resource throttling operations, then this value MUST be 1. Otherwise, it MUST be 0.

HasRelatedLists: This value MUST be NULL.

Followable: If this list is followable, then this value MUST be 1. Otherwise, it MUST be 0.

tp_ValidationFormula: This value MUST be NULL.

tp_ValidationMessage: This value MUST be NULL.

TitleResource: This value MUST be NULL.

DescriptionResource: This value MUST be NULL.

tp_ACL: When the *@FAclInfo* parameter is set to 1, this MUST contain a binary array of the ACL for this list if one is defined; otherwise, it MUST be NULL.

3.1.5.17.2 Recycle Bin Information Result Set

The **Recycle Bin Information Result Set** returns information about list items from the specified list that the specified user marked as deleted in the Recycle Bin.

If the *@FRecycleBinInfo* parameter is 1, the **Recycle Bin Information Result Set** MUST be returned and MUST contain a single row with two columns specified as follows.

```
{RecycleBinCount}      int,  
{RecycleBinSize}      int;
```

{RecycleBinCount}: Contains a count of the number of items in the Recycle Bin matching the specified user and list.

{RecycleBinSize}: Contains the total size, in bytes, of items in the Recycle Bin matching the specified user and list.

3.1.5.17.3 NULL Result Set

The **NULL Result Set** is an empty placeholder returned when Recycle Bin information is not requested. The **NULL Result Set** MUST only be returned if the *@FRecycleBinInfo* parameter is not 1 and MUST contain no rows, in a schema consisting of a single, unnamed NULL column.

3.1.5.18 proc_ReadStream

The **proc_ReadStream** stored procedure is called to read a specific range of data from a document's stream binary piece.

```
PROCEDURE proc_ReadStream (  
    @SiteId          uniqueidentifier,  
    @ParentId        uniqueidentifier,  
    @DocId           uniqueidentifier,  
    @Level           tinyint,  
    @Partition       tinyint,  
    @BSN            bigint,  
    @Offset          int,  
    @Length          int
```

);

@SiteId: The site collection identifier for a site collection containing the document.

@ParentId: The document identifier (2) of the document's parent container.

@DocId: The document identifier (2) of the document to read from.

@Level: The publishing level of the document.

@Partition: The stream partition which contains the stream binary piece to read.

@BSN: The BLOB sequence number of the stream binary piece to read.

@Offset: The offset, in bytes, into the stream binary piece to begin reading.

@Length: The number of bytes to read from the stream binary piece.

Return Values: This stored procedure returns an integer return code which MUST be listed in the following table.

| Value | Description |
|-------|---|
| 0 | Successful execution. |
| 30 | There was an IO error reading the data. |

Result Sets: The **proc_ReadStream** stored procedure MUST return the **Document Stream Chunk Result Set** (section [3.1.5.18.1](#)).

3.1.5.18.1 Document Stream Chunk Result Set

The **Document Stream Chunk Result Set** contains a range of bytes read from a document's stream binary piece.

```
{Content} varbinary(max);
```

{Content}: The data read from the document's stream binary piece.

3.1.5.19 proc_FetchDocForHttpGet

The **proc_FetchDocForHttpGet** stored procedure is called to fetch a document stream and provide information necessary to render the document on a front-end Web server.

```
PROCEDURE proc_FetchDocForHttpGet (  
    @DocSiteId uniqueidentifier,  
    @DocDirName nvarchar(256),  
    @DocLeafName nvarchar(128),  
    @LooksLikeAttachmentFile bit,  
    @IfModifiedSince datetime,  
    @FetchType int,  
    @ValidationType int,  
    @ClientVersion int,  
    @ClientId uniqueidentifier,  
    @PageView tinyint,
```



```

@FetchBuildDependencySet      bit,
@SystemID                     varbinary(512),
@AppPrincipalName             nvarchar(256),
@IsHostHeaderAppPrincipalName bit,
@CurrentVirusVendorID         int,
@PrefetchListScope           bit,
@ChunkSize                    int,
@DGCacheVersion               bigint,
@MaxCheckinLevel              tinyint,
@HonorLevel                   bit,
@CurrentFolderUrl             nvarchar(260),
@ThresholdRowCount            int,
@StreamPartition              tinyint,
@Level                        tinyint          OUTPUT,
@FetchStreamIfNeeded          bit = 1,
@RequestGuid                  uniqueidentifier = NULL OUTPUT
);

```

@DocSiteId: The site collection identifier for a site collection containing the document.

@DocDirName: The directory name of the requested document.

@DocLeafName: The leaf name of the requested document.

@LooksLikeAttachmentFile: Boolean flag that specifies if the document is an attachment to a list item or an attachment folder.

@IfModifiedSince: Specifies the datetime in UTC of the last modified time stamp of the document. If **@ValidationType** is "2" or "3", the document MUST only be fetched if this value is earlier than the current last modified time stamp value in the back-end database server.

@FetchType: Specifies the type of request. If this parameter is "0", information to satisfy an HTTP GET request MUST be returned, including the stream (1) of the document. If this parameter is "1", information needed only to satisfy an **HTTP HEAD** request MUST be returned, which does not include the stream (1) of the document. All nonzero values MUST also be treated as "1".

@ValidationType: This parameter MUST have a value of "0", "1", "2", or "3". If this parameter is "0", **@ClientVersion**, **@ClientId**, and **@IfModifiedSince** MUST be ignored and the document MUST be fetched.

@ClientVersion: Specifies the internal version number of the document to fetch. If **@ValidationType** is "1" or "3", the document MUST only be fetched if this value is equal to the current internal version number of the document on the back-end database server.

@ClientId: Specifies the document identifier (2) of the document to fetch. If **@ValidationType** is "1" or "3", the document MUST only be fetched if this value is equal to the current document identifier (2) of the document on the back-end database server.

@PageView: Non-NULL values indicate that the document is a view Web page or an implementation-specific Web page that renders an item or items in a list (1) or document library. This also indicates that information is needed to enable front-end Web server rendering based on metadata about the view page, the item or items being rendered, the user's browsing context, the overall site's navigation scheme, and the user's security privileges. Information requested includes site metadata, containing list (1) metadata, users and permission levels metadata, Web Parts, and related list (1) metadata. In addition, a value of one indicates that the metadata is security trimmed to the user

specified by *@SystemId*. The value zero or other non-NULL values indicate that information is requested as seen by all users. A NULL value indicates that the document is not a view Web page.

@FetchBuildDependencySet: If this parameter is "1" and the document being fetched has a publishing level of published, the **Document Build Dependency Set Result Set** (section [3.1.5.19.12](#)) and **Document Build Dependency Metadata Result Set** (section [3.1.5.19.13](#)) MUST be returned. Otherwise, the result sets MUST NOT be returned.

@SystemID: The **security identifier (SID)**, as specified in [\[MS-DTYP\]](#) section 2.4.2, of the current user, or NULL to indicate an anonymous user.

@AppPrincipalName: The app principal identifier or the app web domain identifier associated with the current user. If the current user is not associated with an app principal, this parameter MUST be NULL.

@IsHostHeaderAppPrincipalName: If this parameter is set to one, the *@AppPrincipalName* parameter MUST be the app principal identifier, else it MUST be the app web domain identifier.

@CurrentVirusVendorID: Specifies an identifier for an anti-virus scanner. If this value is not NULL and does not match the current anti-virus scanner registered for the document, the document MUST not be fetched.

@PrefetchListScope: If this parameter is set to "1", the metadata of the list (1) scope that contains the document MUST be returned.

@ChunkSize: Specifies the maximum size, in bytes, of the document content to be returned in the **{Content}** column in the **Document Information (Get) Stream Result Set** (section [3.1.5.19.9](#)). For an uncustomized document, this MUST be NULL. Otherwise, if the data in the **{Content}** column is larger than the value specified in the *@ChunkSize* parameter, only the first *@ChunkSize* bytes MUST be returned, and the front-end Web server can request individual chunks of content in a subsequent request.

@DGCACHEVersion: Specifies an internal version number for the domain group map cache of the site collection that contains this document being request. If this parameter is "-2", the **Domain Group Cache BEDS Update Result Set** (section [3.1.5.19.3](#)) and the **Domain Group Cache WFE Result Set** (section [3.1.5.19.4](#)) MUST not be returned. Otherwise, the **Domain Group Cache BEDS Update Result Set** MUST be returned, and the **Domain Group Cache WFE Update Result** MUST only be returned if *@DCCACHEVersion* is less than the current internal version number of the domain group map cache.

@MaxCheckinLevel: Specifies the publishing level of the document to fetch. If *@HonorLevel* is equal to "0", this parameter MUST be ignored.

@HonorLevel: If this parameter is not equal to "0", the document with publishing level specified in *@MaxCheckInLevel* MUST be fetched. Otherwise, the document with the maximum publishing level available to the current user MUST be fetched.

@CurrentFolderUrl: The URL of the folder that the user was browsing before the specified document was requested. This is used to preserve the browsing context when the fetch request is redirected to a view page. When fetching an item in a list (1) or a **file** in a document library, an attachment to an item, a folder, or a list view, the specified document will be a view page, and *@CurrentFolderUrl* will be used to render the browsing context.

@ThresholdRowCount: Specifies the maximum number of security scopes to be fetched. If *@PrefetchListScope* is not equal to "1", this parameter MUST be ignored.

@StreamPartition: Specifies the stream partition of the document to fetch.

@Level: An output parameter specifying the publishing level of the document to be fetched.

@FetchStreamIfNeeded: Specifies if the stream (1) of the document is fetched.

@RequestGuid: The optional request identifier for the current request.

Return Values: The **proc_FetchDocForHttpGet** stored procedure returns an integer return code, which MUST be one of those listed in the following table.

| Value | Description |
|-------|---|
| 0 | Successful execution. |
| 2 | The document specified by <i>@DocSiteId</i> , <i>@DocDirName</i> , <i>@DocLeafName</i> (and <i>@MaxCheckinLevel</i> , if provided) was not found, or the document is an attachment folder; or the document is a folder, but no welcome page, home page , view Web page, or other redirect Web page was found for it. |
| 18 | Successful execution; based on values of <i>@ValidationType</i> , <i>@ClientId</i> , <i>@ClientVersion</i> , and <i>@IfModifiedSince</i> , the document was not fetched. |
| 146 | The document does not exist, but a welcome page was found, as specified by the Welcome Page Redirect Information Result Set. |
| 1168 | The site collection specified by <i>@DocSiteId</i> was not found. |
| 1271 | The site is read locked. |

Result Sets: The **proc_FetchDocForHttpGet** stored procedure MUST return zero or more result sets upon successful execution. If the document is not found, zero result sets MUST be returned. The following result sets MUST be returned only if the document has a **Document Store Type** (section [2.2.2.4](#)) of zero (File):

- **Site Collection Audit Mask Result Set** (section [3.1.5.19.10](#))
- **List Audit Mask Result Set** (section [3.1.5.19.11](#))
- **Document Build Dependency Set Result Set** (section [3.1.5.19.12](#))
- **Document Build Dependency Metadata Result Set** (section [3.1.5.19.13](#))
- **Domain Group Cache Versions Result Set** (section [3.1.5.19.2](#))
- **Site Metadata Result Set** (section [3.1.5.19.14](#))
- **Event Receivers Result Set** (section [3.1.5.19.15](#))
- **Web Event Receiver Result Set** (section [3.1.5.19.16](#))
- **Site Features List Result Set** (section [3.1.5.19.17](#))
- **WebParts Metadata, Personalized Result Set** (section [3.1.5.19.18](#))
- **WebParts Metadata, Nonpersonalized Result Set** (section [3.1.5.19.19](#))
- **ListMetadata Result Set** (section [3.1.5.19.20](#))
- **List Event Receivers Result Set** (section [3.1.5.19.21](#))
- **List Security Information Result Set** (section [3.1.5.19.22](#))

- **Site Collection Custom Actions Result Set** (section [3.1.5.19.23](#))
- **Site Custom Actions Result Set** (section [3.1.5.19.24](#))
- **List Custom Actions Result Set** (section [3.1.5.19.25](#))
- **List Web Parts Result Set** (section [3.1.5.19.26](#))
- **Content Type Order Result Set** (section [3.1.5.19.27](#))
- **Current Folder Scope Result Set** (section [3.1.5.19.28](#))
- **Navigation Context Security Information Result Set** (section [3.1.5.19.29](#))
- **NULL Navigation Context Security Information Result Set** (section [3.1.5.19.30](#))
- **Empty Navigation Context Security Information Result Set** (section [3.1.5.19.31](#))

Other **proc_FetchDocForHttpGet** result sets return conditionally, as described in each result set section, in the following sections.

3.1.5.19.1 HTTP Document Metadata Result Set

The **HTTP Document Metadata Result Set** returns the core document metadata, including the effective security permission and anonymous permission mask. This result set MUST be returned if the specified document exists.

| | |
|--------------------------------|-------------------|
| {Size} | int, |
| {DocFlags} | int, |
| {FullUrl} | nvarchar(260), |
| {WebId} | uniqueidentifier, |
| {FirstUniqueWebId} | uniqueidentifier, |
| {SecurityProvider} | uniqueidentifier, |
| {Dirty} | bit, |
| {TimeLastWritten} | datetime, |
| {CharSet} | int, |
| {Version} | int, |
| {DocId} | uniqueidentifier, |
| {LeafName} | nvarchar(128), |
| InDocLibrary | bit, |
| IsAttachment | bit, |
| NeedManageListRight | int, |
| {SiteFlags} | int, |
| Acl | varbinary(max), |
| AnonymousPermMask | bigint, |
| {ListIdForPermissionCheck} | uniqueidentifier, |
| {PermCheckedAgainstUniqueList} | int, |
| DraftOwnerId | int, |
| ListFlags | bigint, |
| Level | tinyint, |
| {IsCurrentVersion} | bit, |
| {Type} | tinyint, |
| {VirusVendorID} | int, |
| {VirusStatus} | int, |
| {VirusInfo} | nvarchar(255), |
| {VirusInfoEx}, | varbinary(max), |
| {ContentModifiedSince} | bit, |
| {ProgId} | nvarchar(255), |

```

        {DoclibRowId}                int,
        {Language}                  int,
        {DirName}                   nvarchar(256),
        {UIVersion}                 int,
        {ContentVersion}            int,
        {RbsCollectionId}           int,
        {NextBSN}                   bigint,
        {StreamSchema}              byte,
        {InternalVersion}           int,
        {WebFlags}                  int,
        {AppWebDomainId}            varchar(8),
        {SiteAppHostHeader}         nvarchar(55),
        {DocScopeId}                uniqueidentifier,
        {DenyPermMask}             tPermMask
;

```

{Size}: The size, in bytes, of the document stream.

{DocFlags}: A **Doc Flags** value (section [2.2.2.3](#)) describing the document.

{FullUrl}: The complete store-relative form URL for the requested document.

{WebId}: The site identifier of the site (2) containing the document.

{FirstUniqueWebId}: The site identifier of the site (2) whose security permissions are the effective security permission for the site (2) containing the specified document.

{SecurityProvider}: COM CLSID of the **security provider (1)** for this site (2).

{Dirty}: A bit that specifies this document MUST have implementation-specific processing performed before its stream (1) can be returned. If this document does not require processing, this value MUST be zero. If this document does not have a stream (1), this value MUST be NULL.

{TimeLastWritten}: The datetime, in UTC, when the document stream was last modified.

{CharSet}: A character set (2) associated with the document. This value MUST be NULL or a valid Windows code page identifier.

{Version}: The internal version number of the document being returned.

{DocId}: The document identifier (2) of the requested document.

{LeafName}: The leaf name of the requested document.

InDocLibrary: If the document is in a document library, this value MUST be "1".

IsAttachment: If the document is an attachment, this value MUST be "1".

NeedManageListRight: If the user is required to have the Manage List right to read the document, this value MUST be "1".

{SiteFlags}: A **Site Collection Flags** value (section [2.2.2.9](#)) describing the configuration of the site collection containing the document.

Acl: The **WSS ACL Format** (section [2.2.3.6](#)) permissions for the document.

AnonymousPermMask: A **WSS Rights Mask** (section [2.2.2.15](#)) that indicates the rights granted to an anonymous user on this document.

{ListIdForPermissionCheck}: The GUID for the list (1) containing the document. This value MUST be NULL if this document is not in a list (1).

{PermCheckedAgainstUniqueList}: MUST be zero.

DraftOwnerId: The identifier for the user who published the document as a draft version. If the document is not a draft version, this value MUST be NULL.

ListFlags: A **List Flags** value (section [2.2.2.5](#)) describing the list (1) that contains the document. If the document is not in a list (1), the value MUST be zero.

Level: The publishing level value of this document.

{IsCurrentVersion}: If the document being returned is the current version, as defined by the implementation, this value MUST be "1", else this value MUST be "0".

{Type}: The **Document Store Type** (section [2.2.2.4](#)) of this document.

{VirusVendorID}: The identifier of the anti-virus vendor that processed this document. This value MUST be NULL if the document has not been processed by an anti-virus scanner.

{VirusStatus}: The **Virus Status** (section [2.2.1.2.17](#)) of the document. This value MUST be NULL if the requested document does not exist or if it has not been processed by an anti-virus scanner.

{VirusInfo}: A anti-virus scanner specific message returned by the anti-virus scanner when it last processed the document.

{VirusInfoEx}: A binary value that specifies extensible virus information for this document, which is opaque to the back-end server.

{ContentModifiedSince}: A bit indicating whether the document has been modified, depending on the validation type in use. This MUST be set to one if any of the following are true:

- the document is a dynamic document type.
- the document requires a dependency update.
- validation type is "None" (0).
- validation type is "E-tag" (1) and the value of *@ClientVersion* disagrees with the document version in the store or the value of *@ClientId* disagrees with the document identifier (2) in the store.
- validation type is "Last modified" (2) and the last modification date of the document in the store is more recent than specified in *@IfModifiedSince*.

In all other cases, **ContentModifiedSince** MUST be set to zero.

{ProgId}: Specifies an implementation-specific preferred application to open the document.

{DoclibRowId}: The identifier of the list item which represents this document if it belongs in a list (1). If the requested document is not contained in a list (1), this value MUST be NULL.

{Language}: The LCID of the **locale** of the site (2).

{DirName}: The directory name of the requested document.

{UIVersion}: The displayed version number of the document being returned.

{ContentVersion}: The version number of the document stream being returned.

{RbsCollectionId}: The identifier for the remote BLOB storage collection for the site collection, or zero if remote BLOB storage is not configured for this database.

{NextBSN}: The current BLOB sequence number of the document being returned.

{StreamSchema}: The current stream schema of the document being returned.

{InternalVersion}: The current internal version number of the document being returned.

{WebFlags}: A **Site Property Flags** value (section [2.2.2.11](#)) describing the configuration of the site (2) containing the document.

{AppWebDomainId}: The app web domain identifier of the site (2) containing the document being returned.

{SiteAppHostHeader}: The **app host header name** of the site collection containing the document being returned.

{DocScopeId}: The GUID identifying the security scope of the document. This value MUST NOT be NULL.

{DenyPermMask}: A **WSS Rights Mask** (section [2.2.2.15](#)) specifying the rights to deny to the current user.

3.1.5.19.2 Domain Group Cache Versions Result Set

The **Domain Group Cache Versions Result Set** contains information about the version numbers associated with the Domain Group Map Caches on the front-end Web server and on the back-end database server for the specified site collection.

The **Domain Group Cache Versions Result Set** MUST be returned if the specified document exists and MUST contain one row of version number data. If the specified *@DGCacheVersion* value is -2, then all columns returned MUST have the value -2, indicating that the value MUST NOT be used for comparison. The **Domain Group Cache Versions Result Set** is defined in the Common Result Sets **Domain Group Cache Versions Result Set** (section [2.2.4.4](#)).

3.1.5.19.3 Domain Group Cache BEDS Update Result Set

The **Domain Group Cache BEDS Update Result Set** contains information to be used in recomputing the Domain Group Map Cache.

The **Domain Group Cache BEDS Update Result Set** MUST be returned if *@DGCacheVersion* is not -2 ('Skip') and the real Domain Group Map Cache version is more recent than the cached version on the back-end database server; that is, if the value of **RealVersion** is greater than the value of **CachedVersion** in the **Domain Group Cache Versions Result Set** (section [2.2.4.4](#)).

If the **Domain Group Cache BEDS Update Result Set** is returned, it indicates that the copy of the Domain Group Map Cache on the back-end database server is out of date and MUST be recomputed to ensure that proper security checks can be made.

When returned, the **Domain Group Cache BEDS Update Result Set** MUST have a single row. The **Domain Group Cache BEDS Update Result Set** is defined in the Common Result Sets **Domain Group Cache BEDS Update Result Set** (section [2.2.4.3](#)).

3.1.5.19.4 Domain Group Cache WFE Update Result Set

The **Domain Group Cache WFE Update Result Set** contains the binary data needed to refresh the domain group map cache.

The **Domain Group Cache WFE Update Result Set** MUST be returned only if *@DGCacheVersion* is not -2 ('Skip') and the cached version on the back-end database server is up-to-date; that is, if the value of **RealVersion** is not greater than the value of **CachedVersion** in the **Domain Group Cache BEDS Update Result Set** (section [2.2.4.3](#)).

The **Domain Group Cache WFE Update Result Set** is defined in the Common Result Sets **Domain Group Cache WFE Update Result Set** (section [2.2.4.5](#)).

3.1.5.19.5 User Information Result Set

The **User Information Result Set** returns information about the user specified in *@UserId*.

| | |
|------------------------------------|-----------------|
| <i>tp_Id</i> | int, |
| <i>tp_SiteAdmin</i> | bit, |
| <i>tp_IsActive</i> | bit, |
| <i>tp_Login</i> | nvarchar(255), |
| <i>tp_Email</i> | nvarchar(255), |
| <i>tp_Title</i> | nvarchar(255), |
| <i>tp_Notes</i> | nvarchar(1023), |
| <i>tp_ExternalTokenLastUpdated</i> | datetime, |
| <i>tp-Token</i> | varbinary(max), |
| <i>tp_Flags</i> | int, |
| <i>UserId</i> | int, |
| <i>SiteSecurityVersion</i> | bigint; |

tp_Id: The user identifier.

tp_SiteAdmin: Indicates whether the specified user is a site collection administrator on the site collection specified by *@DocSiteId*.

tp_IsActive: MUST be set to "1" if the specified user is an active user in the site collection specified by *@DocSiteId*.

tp_Login: The login name of the specified user.

tp_Email: The e-mail address of the specified user.

tp_Title: The display name of the specified user.

tp_Notes: Notes about the specified user.

tp_ExternalTokenLastUpdated: The date and time, in UTC format, when the **External Group Token** for the specified user was last updated.

tp-Token: A **WSS User Token** value specifying the permission level membership of the specified user.

tp_Flags: A **WSS User Flags** value for the specified user.

UserId: The site membership identifier of the specified user. This parameter can be NULL if the user has not been added as a member (1) to the site whose permissions are in effect on the document.

SiteSecurityVersion: The current security information version of the site collection containing this document.

3.1.5.19.6 Welcome Page Redirect Information Result Set

The **Welcome Page Redirect Information Result Set** returns whether or not the document is a site or a folder with a configured welcome page, or the welcome page itself. The **Welcome Page Redirect Information Result Set** contains information about the welcome page.

| | |
|-----------------------|-----------------|
| {RedirectType} | tinyint, |
| {RedirectUrl} | nvarchar(260), |
| WelcomePageParameters | nvarchar(max), |
| {ContentTypeId} | varbinary(512); |

{RedirectType}: The **Redirect Type** of the URL. MUST be 0, indicating a welcome page redirect URL.

{RedirectUrl}: The URL of the welcome page.

WelcomePageParameters: This MUST contain any URL parameters configured for the welcome page. This value can contain a query string starting with "?" or a hash parameter starting with "#".

{ContentTypeId}: This value MUST be NULL.

3.1.5.19.7 Non-Welcome Page Redirect Information Result Set

The **Non-Welcome Page Redirect Information Result Set** returns if the document is a site or a folder, where a welcome page is not configured. Depending on the specified document URL, the redirect can be to a home page, a list view Web page, or to a provisioning page URL. The **Non-Welcome Page Redirect Information Result Set** contains information about the redirect URL. The **Non-Welcome Page Redirect Information Result Set** MUST return a single row.

| | |
|-------------------------|-----------------|
| {RedirectType} | tinyint, |
| {RedirectUrl} | nvarchar(260), |
| {WelcomePageParameters} | nvarchar(max), |
| {ContentTypeId} | varbinary(512); |

{RedirectType}: The **Redirect Type** (section [2.2.1.2.15](#)) of the URL. This parameter MUST NOT be 0. For all other valid values, see the **Redirect Type** section.

{RedirectUrl}: The full redirect URL.

{WelcomePageParameters}: MUST be NULL.

{ContentTypeId}: The document's content type identifier.

3.1.5.19.8 Document Information (Get) Metadata Result Set

This result set contains the metadata for the document's binary stream (1). This row set MUST be returned only if *@FetchType* is not set to 1, otherwise, the row set MUST not be returned.

This result set MUST return zero or one rows. If the document is modified, then a single row MUST be returned. A document is considered modified subject to the semantics indicated by the input parameter *@ValidationType*, or if its Virus Vendor ID has been updated since the client last retrieved it. When the document is modified, the return code 18 MUST be returned upon successful completion of **proc_FetchDocForHttpGet**. Otherwise, zero rows MUST be returned.

The value returned in the **{HistVersion}** column MUST be 0.

This result set is defined as **Document Content Metadata Result Set** (section [2.2.4.6](#)) in the Common Result Sets (section [2.2.4](#)).

3.1.5.19.9 Document Information (Get) Stream Result Set

This result set contains a row for each of the document's stream binary pieces. This row set MUST be returned only if *@FetchType* is not set to 1.

This result set MUST return zero or more rows. If *@FetchStreamIfNeeded* is not set to 1 or the document requires dependency update processing or the document is an uncustomized document, this row set MUST contain 0 rows.

This result set is defined as **Document Content Stream Result Set** (section [2.2.4.7](#)) in the Common Result Sets (section [2.2.4](#)).

3.1.5.19.10 Site Collection Audit Mask Result Set

The **Site Collection Audit Mask Result Set** contains the information about the **Audit Flags** associated with the site collection containing the specified document.

The **Site Collection Audit Mask Result Set** is defined in the Common Result Sets **Site Audit Mask Result Set** (section [2.2.4.22](#)).

3.1.5.19.11 List Audit Mask Result Set

The **List Audit Mask Result Set** contains information about the **Audit Flags** associated with the list containing the document.

The **List Audit Mask Result Set** MUST return one row if the document is contained in a list; otherwise, zero rows MUST be returned.

| | |
|-----------------------------------|--------------------------------|
| <code>tp_Id</code> | <code>uniqueidentifier,</code> |
| <code>tp_AuditFlags</code> | <code>int,</code> |
| <code>tp_InheritAuditFlags</code> | <code>int,</code> |
| <code>{GlobalAuditMask}</code> | <code>int,</code> |
| <code>{URL}</code> | <code>nvarchar(516)</code> |

tp_Id: The List Identifier of the list containing the document.

tp_AuditFlags: An **Audit Flags** value determining the operations to be tracked on the list.

tp_InheritAuditFlags: An **Audit Flags** value determining the operations to be tracked on the document as inherited from the document's container.

{GlobalAuditMask}: An **Audit Flags** value determining the operations to be tracked across the site collection that contains the document.

{URL}: The URL of the list containing the document.

3.1.5.19.12 Document Build Dependency Set Result Set

The **Document Build Dependency Set Result Set** returns a build dependency set for a published document. The **Document Build Dependency Set Result Set** MUST return only when `@FetchBuildDependencySet` is set to 1 and when the document is published.

```
BuildDependencySet          varbinary(max);
```

BuildDependencySet: A binary array holding implementation-specific information about dependent documents. NULL indicates that there is no information about dependencies. A **BuildDependencySet** of size 0 indicates a document with no dependencies.

3.1.5.19.13 Document Build Dependency Metadata Result Set

The **Document Build Dependency Metadata Result Set** contains information about each document in the specified document's build dependency set. This result set MUST be returned only if the `@FetchBuildDependencySet` is set to one and the binary array returned in the **Document Build Dependency Set Result Set** (section [3.1.5.19.12](#)) is not NULL and is not of zero-length.

```
DirName                    nvarchar(256),
LeafName                   nvarchar(128),
WebsFullUrl                nvarchar(256),
FirstUniqueAncestorWebId  uniqueidentifier,
SecurityProvider           uniqueidentifier,
Acl                        varbinary(max),
AnonymousPermMask         bigint,
WebId                     uniqueidentifier,
ListId                    uniqueidentifier,
UniqueList                bit,
InDocLibrary               bit,
DraftOwnerId              int,
ListFlags                 bigint,
ProgId                    nvarchar(255),
SetupPathVersion          tinyint,
SetupPath                 nvarchar(255),
TimeLastWritten           datetime,
MasterUrl                 nvarchar(260),
CustomMasterUrl           nvarchar(260),
Version                   int,
Id                        uniqueidentifier,
BuildDependencySet        varbinary(max);
```

DirName: The directory name of the document.

LeafName: The leaf name of the document.

WebsFullUrl: The store-relative form URL of the document.

FirstUniqueAncestorWebId: The site identifier of the closest site (2) in this site's ancestor chain that does not inherit security settings from its parent site.

SecurityProvider: COM **CLSID** of the external security provider for this site (2). This MUST be NULL for sites (2) using the native security implementation.

Acl: The binary serialization of the **WSS ACL Format** (section [2.2.3.6](#)) ACL for this site (2).

AnonymousPermMask: A **WSS Rights Mask** (section [2.2.2.15](#)) that indicates the rights granted to a user that is anonymous, or has no specific rights, to the document.

WebId: The site identifier for a site (2) containing the document.

ListId: The list identifier for the list (1) containing the document.

UniqueList: This value MUST be zero.

InDocLibrary: The value MUST be set to one if the document is contained within a document library. Otherwise, MUST be set to zero.

DraftOwnerId: The user identifier for the owner of the last checked-in draft version of the document.

ListFlags: A **List Flags** value (section [2.2.2.5](#)) describing the list (1) that contains this document. This value MUST be NULL if the document is not stored in a list (1).

ProgId: Designates a preferred application to open this document. This value MUST be NULL if the document does not exist or the parser did not specify a **ProgId** when the document was saved.

SetupPathVersion: For an uncustomized document, this governs the setup path location to which the **SetupPath** fragment is relative. This value MUST be NULL if the requested document does not exist and is undefined for documents that were never uncustomized. The following are values are valid.

| Value | Description |
|-------|---|
| 2 | The SetupPath is relative to the install location of Windows SharePoint Services 2.0 on the front-end Web server (for example, Program Files\Common Files\Microsoft Shared\Web Server Extensions\60). |
| 3 | The SetupPath is relative to the install location of Windows SharePoint Services 3.0 on the front-end Web server (for example, Program Files\Common Files\Microsoft Shared\Web Server Extensions\12). |
| 4 | Relative to the install location of Microsoft SharePoint Foundation 2010 on the front-end Web server (for example, Program Files\Common Files\Microsoft Shared\Web Server Extensions\14). |
| 15 | The SetupPath is relative to the install location of Microsoft SharePoint Foundation 2013 on the front-end Web server (for example, Program Files\Common Files\Microsoft Shared\Web Server Extensions\15). |

SetupPath: For a document that is now or once was uncustomized, this contains the setup path fragment relative to the base setup path described earlier by the **SetupPathVersion** value, where the content stream (1) of this document can be found. This value MUST be NULL in the case of a document that does not exist or a document that was never uncustomized.

TimeLastWritten: A time stamp, in UTC format, specifying when any changes were made to the document stream. Does not reflect changes made strictly to the **MetaInfo** or other item properties.

MasterUrl: The URL for the master page registered on the site (2) for use in pages of the site (2) when rendered on the front-end Web server.

CustomMasterUrl: The URL for an alternate master page registered on the site (2) for use in pages of the site (2) rendered on the front-end Web server.

Version: A counter incremented any time a change is made to this document.

Id: The document identifier (2).

BuildDependencySet: A **varbinary(max)** value specifying further document dependencies.

3.1.5.19.14 Site Metadata Result Set

The **Site Metadata Result Set** contains metadata for the site containing the specified document. The **Site Metadata Result Set** MUST return only if the input parameter *@PageView* is not NULL, as part of a series of result sets describing view Web page document metadata.

The **Site Metadata Result Set** is defined in the Common Result Sets **Site Metadata Result Set** (section [2.2.4.24](#)).

3.1.5.19.15 Event Receivers Result Set

The **Event Receivers Result Set** contains information about the event receivers defined for the site containing the specified document.

The Event Receivers Result Set is part of a series of result sets describing view Web page-related metadata. It MUST return only if the input parameter *@PageView* is not NULL, and it will not return if **proc_FetchDocForHttpGet** returns a return code of 1271, indicating that the site collection was locked.

The **Event Receivers Result Set** MUST contain one row per event receiver registered for the site. The **Event Receivers Result Set** is defined in the Common Result Sets **Event Receivers Result Set** (section [2.2.4.11](#)).

3.1.5.19.16 Web Event Receiver Result Set

The **Web Event Receivers Result Set** contains information about the event receivers defined for the site containing the specified document.

The **Web Event Receivers Result Set** is part of a series of result sets describing view Web page-related metadata. It MUST return only if the input parameter *@PageView* is not NULL, and it will not return if **proc_FetchDocForHttpGet** returns a return code of 1271, indicating that the site collection was **locked**.

The **Event Receivers Result Set** MUST contain one row per event receiver registered for the site. The Event Receiver Result Set is defined in the Common Result Sets **Event Receivers Result Set** (section [2.2.4.11](#)).

3.1.5.19.17 Site Features List Result Set

The **Site Features List Result Set** returns information about available features. If the **Site Features List Result Set** returns, it MUST return twice: first, for site collection features, and then for site features, for the site and site collection that contain the specified document.

The **Site Features List Result Set** MUST return only if *@PageView* is not NULL, and it will not return if **proc_FetchDocForHttpGet** returns a code of 1271, indicating that the site collection was locked.

The **Site Features List Result Set** is defined in the Common Result Sets **Site Feature List Result Set** (section [2.2.4.23](#)).

3.1.5.19.18 WebParts Metadata, Personalized Result Set

The **Web Parts Metadata, Personalized Result Set** contains the core metadata about the Web Parts appearing on the specified document, personalized for the user specified in *@UserId*.

The **Web Parts Metadata, Personalized Result Set** is part of a series of result sets describing view Web page-related metadata. It MUST return only if the input *@PageView* is not 0.

The **Web Parts Metadata, Personalized Result Set** will not return if **proc_FetchDocForHttpGet** returns a code of 1271, indicating that the site collection was locked.

The **Web Parts Metadata, Personalized Result Set** MUST contain one row per Web Part.

| | |
|-------------------------|-------------------|
| tp_Id | uniqueidentifier, |
| {tp_ZoneID} | nvarchar(64), |
| tp_WebPartTypeId | uniqueidentifier, |
| tp_Assembly | nvarchar(255), |
| tp_Class | nvarchar(255), |
| tp_SolutionId | uniqueidentifier, |
| Hash | nvarchar(50), |
| ValidatorsHash | nvarchar(64), |
| ValidationErrorUrl, | nvarchar(4000), |
| ValidationErrorMessage, | nvarchar(4000), |
| {tp_IsIncluded} | bit, |
| {tp_FrameState} | tinyint, |
| tp_AllUsersProperties | varbinary(max), |
| {tp_PerUsersProperties} | varbinary(max), |
| {tp_PartOrder} | int, |
| {tp_Flags} | int, |
| {AllUsers} | int, |
| tp_Version | int, |
| tp_Cache | varbinary(max), |
| {Per_tp_Cache} | varbinary(max), |
| {tp_ListId} | nvarchar(38), |
| tp_Type | tinyint, |
| tp_Source | nvarchar(max), |
| tp_BaseViewId | int, |
| tp_View | nvarchar(max); |

tp_Id: The Web Part Identifier of the Web Part. This value MUST NOT be NULL.

tp_ZoneId: The name of a Web Part zone. This value can be NULL.

tp_WebPartTypeId: A 16-byte value uniquely identifying the type of the Web Part. MUST NOT be NULL.

tp_Assembly: The assembly name of the implementation of the Web Part.

tp_Class: The **fully qualified class name** of the implementation of the Web Part.

SolutionId: The solution identifier of the solution. MUST be NULL if there is no solution associated with the Web Part.

Hash: The implementation-specific hash of the content of the sandboxed solution. This value MUST be NULL if there is no solution associated with the Web Part.

ValidatorsHash: The implementation-specific hash of the sandboxed solution validators that validated the sandboxed solution. This value MUST be NULL if there is no solution associated with the Web Part.

ValidationErrorUrl: The URL to render if the sandboxed solution validator failed validation. This value MUST be NULL if there is no solution associated with the Web Part.

ValidationErrorMessage: The error message string to render if the sandboxed solution validator failed validation. This value MUST be NULL if there is no solution associated with the Web Part.

{tp_IsIncluded}: If this bit flag is set to 1, it indicates that the Web Part is visible. Otherwise, it MUST be 0.

{tp_FrameState}: A value that indicates the frame state of the Web Part. This value MUST be one of the following.

| Value | Description |
|-------|--|
| 0 | Normal. The Web Part is displayed in its normal state, with title, content, and placement within the page. |
| 1 | Minimized. The Web Part is collapsed. |

tp_AllUsersProperties: Web Part Properties specified for all users. This value can be NULL.

{tp_PerUsersProperties}: Web Part Properties specified for per-user basis. This value can be NULL.

{tp_PartOrder}: Ordinal number that indicates the location of the Web Part in relation to other Web Parts in the same zone. This value can be NULL.

{tp_Flags}: A **View Flags** value that specifies view-related settings for this Web Part. This value can be equal to 0.

{AllUsers}: A flag that indicates whether customization or personalization is in effect on this Web Parts page. This value MUST be one of the following.

| Value | Description |
|-------|--|
| 1 | User not specified; changes apply to all users of this Web Part instance. Also indicates customization mode. |
| 2 | Personalization is in effect; changes apply to the tp_UserId in the Personalization Table. |
| 3 | Personalization is in effect; changes apply to the tp_UserId in the Web Parts Table. |

tp_Version: A counter incremented any time a change is made to the schema or other properties of this list and used for internal conflict detection.

tp_Cache: Private data cache for the Web Part. This value can be NULL.

{Per_tp_Cache}: Contains the private data cache for documents with a checkout level of 'published'. Otherwise, this MUST be NULL.

{tp_ListId}: The List Identifier of the list to which this Web Part refers, enclosed in braces. If not referencing a list, then this value MUST be NULL.

tp_Type: The **Page Type** of this Web Part. This value can be NULL.

tp_Source: Properties of the Web Part, as specified by a compatible HTML editor. This value can be NULL.

tp_BaseViewId: the id of the base view for the list view Web Part. This value can be NULL.

tp_View: Contains implementation-specific XML used when processing this Web Part. If this Web Part is not a view, then this MUST be NULL.

3.1.5.19.19 Web Parts Metadata, Nonpersonalized Result Set

The **Web Parts Metadata, Nonpersonalized Result Set** contains the core metadata about the Web Parts appearing on the specified document.

The **Web Parts Metadata, Nonpersonalized Result Set** is part of a series of result sets describing view Web page-related metadata. It MUST return only if the input *@PageView* is 0.

The **Web Parts Metadata, Nonpersonalized Result Set** will not return if **proc_FetchDocForHttpGet** returns a code of 1271, indicating that the site collection was locked.

The **Web Parts Metadata, Nonpersonalized Result Set** MUST contain one row per Web Part.

| | |
|-------------------------|-------------------|
| tp_Id | uniqueidentifier, |
| tp_ZoneID | nvarchar(64), |
| tp_WebPartTypeId | uniqueidentifier, |
| tp_Assembly | nvarchar(255), |
| tp_Class | nvarchar(255), |
| tp_SolutionId | uniqueidentifier, |
| Hash | nvarchar(50), |
| ValidatorsHash | nvarchar(64), |
| ValidationErrorUrl, | nvarchar(4000), |
| ValidationErrorMessage, | nvarchar(4000), |
| tp_IsIncluded | bit, |
| tp_FrameState | tinyint, |
| tp_AllUsersProperties | varbinary(max), |
| tp_PerUsersProperties | varbinary(max), |
| tp_PartOrder | int, |
| {tp_Flags} | int, |
| {AllUsers} | int, |
| tp_Version | int, |
| tp_Cache | varbinary(max), |
| {Per_tp_Cache} | varbinary(max), |
| {tp_ListId} | nvarchar(38), |
| tp_Type | tinyint, |
| tp_Source | nvarchar(max), |
| tp_BaseViewId | int, |
| tp_View | nvarchar(max); |

tp_Id: The Web Part Identifier of the Web Part. This value MUST NOT be NULL.

tp_ZoneId: The name of a Web Part zone. This value can be NULL.

tp_WebPartTypeId: A 16-byte value uniquely identifying the type of the Web Part. MUST NOT be NULL.

tp_Assembly: The assembly name of the implementation of the Web Part.

tp_Class: The fully qualified class name of the implementation of the Web Part.

SolutionId: The solution identifier of the solution. MUST be NULL if there is no solution associated with the Web Part.

Hash: The implementation-specific hash of the contents of the sandboxed solution. This value MUST NOT be NULL.

ValidatorsHash: The implementation-specific hash of the sandboxed solution validators that validated the sandboxed solution. This value MUST NOT be NULL.

ValidationErrorUrl: The URL to render if the sandboxed solution validator failed validation. This value MUST be NULL if there is no solution associated with the Web Part.

ValidationErrorMessage: The error message string to render if the sandboxed solution validator failed validation. This value MUST be NULL if there is no solution associated with the Web Part.

tp_IsIncluded: If 1, this indicates that the Web Part is visible. MUST NOT be NULL.

tp_FrameState: A value that indicates the frame state of the Web Part. This value MUST be one of the following.

| Value | Description |
|-------|--|
| 0 | Normal. The Web Part is displayed in its normal state, with title, content, and placement within the page. |
| 1 | Minimized. The Web Part is collapsed. |

tp_AllUsersProperties: Properties specified for all users. This value can be NULL.

tp_PerUsersProperties: Properties specified for per-user basis. This value can be NULL.

tp_PartOrder: Ordinal number that indicates the location of the Web Part in relation to other Web Parts in the same zone. This value can be NULL.

{tp_Flags}: A View Flags value that specifies view-related settings for this Web Part. This value MUST NOT be NULL.

{AllUsers}: A flag that indicates whether customization or personalization is in effect on this Web Parts page. This value MUST be equal to 1, indicating customization.

tp_Version: A counter incremented any time a change is made to the schema or other properties of this list and used for internal conflict detection.

tp_Cache: Private data cache for the Web Part. This value can be NULL.

{Per_tp_Cache}: Private data cache for published documents. This value MUST be NULL.

{tp_ListId}: The List Identifier of the list to which this Web Part refers, enclosed in braces. If not referencing a list, this value MUST be NULL.

tp_Type: The Page Type of this Web Part. This value can be NULL.

tp_Source: Properties of the Web Part as specified by a compatible HTML editor. This value can be NULL.

tp_BaseViewId: the id of the base view for the list view Web Part, the value can be NULL.

tp_View: An **nvarchar(max)** value containing implementation-specific XML used when processing this Web Part. If this Web Part is not a view, this MUST be NULL.

3.1.5.19.20 List Metadata Result Set

The **List Metadata Result Set** contains the metadata for the lists associated with the Web Parts that are included on the specified document.

The **List Metadata Result Set** returns only if there are such Web Parts (at least one row returns in the previously returned result set: **Web Parts Metadata, Personalized**, (section [3.1.5.19.18](#)), or **Web Parts Metadata, Nonpersonalized** (section [3.1.5.19.19](#))).

The **List Metadata Result Set** is part of a series of result sets describing view Web page-related metadata. It MUST be returned only if the input parameter *@PageView* is not NULL, and it MUST NOT be returned if **proc_FetchDocForHttpGet** returns a code of 1271, indicating that the site collection was locked.

The **List Metadata Result Set** MUST return one row for each associated list. The **List Metadata Result Set** is defined in the Common Result Sets **List Metadata Result Set** (section [2.2.4.14](#)).

3.1.5.19.21 List Event Receivers Result Set

The **List Event Receivers Result Set** contains the event receivers registered on the lists associated with the Web Parts that appear on the specified document.

The **List Event Receivers Result Set** MUST return only if there are such lists (the **List Metadata Result Set** (section [2.2.4.14](#)) returns with at least one row).

The **List Event Receivers Result Set** MUST contain one row per event receiver registered. The **List Event Receivers Result Set** can be empty. The **List Event Receivers Result Set** is defined in the Common Result Sets **Event Receivers Result Set** (section [2.2.4.11](#)).

3.1.5.19.22 List Security Information Result Set

The **List Security Information Result Set** contains permissions information for the lists associated with the Web Parts that appear on the specified document.

The **List Security Information Result Set** MUST return only if requested (input parameter *@PrefetchListScope* is set to 1) and if such lists exist (the **List Metadata Result Set** (section [2.2.4.14](#)) returns with at least one row).

The **List Security Information Result Set** returns one row per each unique scope associated with the lists.

| | |
|-------------------|-------------------|
| ListId | uniqueidentifier, |
| ScopeId | uniqueidentifier, |
| Acl | varbinary(max), |
| AnonymousPermMask | bigint; |

ListId: The List Identifier of the list.

ScopeId: The Scope Identifier of the Permissions Scope that applies to the list. This MUST be set to zero if the list does not have Fine grain permission.

Acl: Contains the ACL of the Permissions Scope that applies to the list. This MUST be NULL if **ScopeId** is zero.

AnonymousPermMask: Contains the **WSS Rights Mask** on the list in effect for anonymous users. This MUST be 0 if **ScopeId** is zero.

3.1.5.19.23 SiteCollection Custom Action Result Set

The **Site Collection Custom Actions Result Set** MUST return 1 row for each custom action defined for the site collection containing the specified document.

The **Site Collection Custom Actions Result Set** is part of a series of result sets describing view Web page-related metadata. It MUST return only if the input parameter *@PageView* is not NULL, and it will not return if **proc_FetchDocForHttpGet** returns a return code of 1271, signifying that the site collection was locked.

If there are no custom actions defined for the site collection, this result set MUST NOT return any rows. This result set is defined in the Common Result Sets **Custom Actions From Scope Result Set** (section [2.2.4.2](#)).

3.1.5.19.24 Site Custom Actions Result Set

The **Site Custom Actions Result Set** MUST return 1 row for each custom action defined for the site collection containing the specified document.

The **Site Custom Actions Result Set** is part of a series of result sets describing view Web page-related metadata. It MUST return only if the input parameter *@PageView* is not NULL, and it will not return if **proc_FetchDocForHttpGet** returns a return code of 1271, signifying that the site collection was locked.

If there are no custom actions defined for the site, this result set MUST NOT return any rows. This result set is defined in the Common Result Sets **Custom Actions From Scope Result Set** (section [2.2.4.2](#)).

3.1.5.19.25 List Custom Actions Result Set

The **List Custom Action Result Set** contains information about the Custom Actions related to the lists associated with the specified document.

The **List Custom Actions Result Set** is part of a series of result sets describing view Web page-related metadata. It MUST return only if the input parameter *@PageView* is not NULL, and it will not return if **proc_FetchDocForHttpGet** returns a return code of 1271, signifying that the site collection was locked.

The **List Custom Actions Result Set** MUST return only if such lists exist (the **List Metadata Result Set** (section [2.2.4.14](#)) returns with at least one row).

If there are no custom actions defined for the list, this result set MUST NOT return any rows. This result set is defined in the Common Result Sets **Custom Actions From Scope Result Set** (section [2.2.4.2](#)).

3.1.5.19.26 List Web Parts Result Set

The **List Web Parts Result Set** contains information about the Web Parts related to the lists associated with the specified document.

The **List Web Parts Result Set** MUST return only if such lists exist (the **List Metadata Result Set** (section [2.2.4.14](#)) returns with at least one row).

The **List Web Parts Result Set** MUST contain one row per Web Part registered for each list. The **List Web Parts Result Set** can be empty. The **List Web Parts Result Set** is defined in the Common Result Sets **List Web Parts Result Set** (section [2.2.4.15](#)).

3.1.5.19.27 Content Type Order Result Set

The **Content Type Order Result Set** provides the information necessary for the implementation-specific rendering of a list View Web page. The information necessary to render the content types in the configured order, if such exists, is provided in a binary array value.

The **Content Type Order Result Set** MUST return only if *@PageView* is not NULL, and it will not return if **proc_FetchDocForHttpGet** returns a code of 1271, indicating that the site collection was locked.

```
{CurrentFolderURL}          varchar,  
{MetaInfo}                  varbinary(max)
```

{CurrentFolderURL}: The URL of the current folder as specified in the *@CurrentFolderURL* input parameter.

{MetaInfo}: The information about content type order, embedded in a binary array. If no information is available for the current folder, or if there is no current folder specified, or if the document is not contained in a list, then this parameter MUST be NULL and the column is unnamed. Otherwise, the column MUST be named '**MetaInfo**'.

3.1.5.19.28 Current Folder Scope Result Set

The **Current Folder Scope Result** set contains scope information about the current folder as specified by the input parameter *@CurrentFolderURL*. It is used by the front-end Web server to security trim the information rendered to the user in a view Web page based on the user's access.

The Current Folder Scope Result Set MUST return only if *@PageView* is not NULL, and it MUST NOT return if **proc_FetchDocForHttpGet** returns a code of 1271, indicating that the site collection was locked. In addition, the **Current Folder Scope Result Set** MUST return only if the document is contained in a list and resides in a folder that is not the list's root folder.

If the **Current Folder Scope Result Set** returns, it MUST return one row.

```
{FolderScopeId}            uniqueidentifier,  
{FolderId}                  int;
```

{FolderScopeId}: The Scope Identifier of the security scope effective for the specified folder.

{FolderId}: The integer identifier of the folder document within the containing list.

3.1.5.19.29 Navigation Context Security Information Result Set

The **Navigation Context Security Information Result Set** contains Security information about the site containing the specified document and about all sites in its navigation hierarchy.

The **Navigation Context Security Information Result Set** MUST return only upon successful execution, if *@PageView* is not NULL and the information is not larger than 1,800 bytes.

If the **Navigation Context Security Information Result Set** returns, it MUST return one row for each unique scope in the site's navigation hierarchy, excluding the site's own scope.

The **Navigation Context Security Information Result Set** is defined in the Common Result Sets **Unique Permissions Result Set** (section [2.2.4.26](#)).

3.1.5.19.30 NULL Navigation Context Security Information Result Set

The **NULL Navigation Context Security Information Result Set**, with NULL values in three unnamed columns, returns to indicate that the navigation context security information is larger than 1,800 bytes.

The **NULL Navigation Context Security Information Result Set** MUST return only upon successful execution if *@PageView* is not NULL and the security information about the site or the parent site in the site's navigation hierarchy was larger than 1,800 bytes.

If the **NULL Navigation Context Security Information Result Set** returns, it MUST return one row, as defined in the Common Result Sets **NULL Unique Permissions Result Set** (section [2.2.4.17](#)).

3.1.5.19.31 Empty Navigation Context Security Information Result Set

The **Empty Navigation Context Security Information Result Set**, holding zero rows with a single, unnamed NULL column, is returned to indicate that the navigation context security information is not available or is not up-to-date. The **Empty Navigation Context Security Information Result Set** MUST return only upon successful execution, and if neither the **Navigation Context Security Information** (section [3.1.5.19.29](#)) nor the **NULL Navigation Context Security Information** (section [3.1.5.19.30](#)) Result Sets return.

If the **Empty Navigation Context Security Information Result Set** returns, it MUST return zero rows, as defined using T-SQL syntax in the Common Result Sets **Empty Result Set** (section [2.2.4.10](#)).

3.1.5.19.32 App Principal Information Result Set

If the *@AppPrincipalName* parameter is not NULL, the App Principal Info Result Set MUST be returned as defined in section [2.2.4.29](#).

3.1.5.19.33 App Principal Permissions Result Set

The **App Principal Permissions Result Set** is returned to indicate what permissions the specified app principal has for the document as specified in section [2.2.4.30](#). If the specified app principal has permissions for the specified document, the **App Principal Permissions Result Set** MUST be returned.

3.1.5.20 proc_FetchDocForRead

The **proc_FetchDocForRead** stored procedure is invoked to request the metadata information and document stream of a document.

```
PROCEDURE proc_FetchDocForRead(  
    @DocSiteId                uniqueidentifier,
```

```

@DocWebId                uniqueidentifier,
@DocDirName              nvarchar(256),
@DocLeafName            nvarchar(128),
@DocFullUrl             nvarchar(260),
@LooksLikeAttachmentFile bit,
@GetContent             bit,
@GetWebListForNormalization bit,
@bGetContainingList     bit,
@bCheckout             bit,
@GetCurrentMetaInfo    bit,
@GetLinkInfo           bit,
@UserId                int,
@Version               int,
@ChunkSize             int,
@MaxLevel              tinyint,
@StreamPartition       tinyint,
@Level                 tinyint OUTPUT,
@UIVersion             int OUTPUT,
@RequestGuid           uniqueidentifier = NULL OUTPUT
);

```

@DocSiteId: The **Site Collection Identifier** (section [2.2.1.1.9](#)) of the site collection containing the requested document.

@DocWebId: The **Site Identifier** (section [2.2.1.1.11](#)) of the site (2) containing the requested document.

@DocDirName: The directory name of the requested document.

@DocLeafName: The leaf name of the requested document.

@DocFullUrl: This parameter MUST be NULL and MUST be ignored.

@LooksLikeAttachmentFile: Specifies whether the requested document appears to the front-end Web server to be an attachment to a list item. If this flag is set to 1, then this stored procedure MUST determine whether the current user has sufficient permissions to retrieve the requested document as an attachment. In addition, if this flag is set to 1, then the **NeedManageListRight** column of the **Attachment State Result Set** (section [3.1.5.20.14](#)) will indicate if the **ManageLists** bit of the **WSS Rights Mask** (section [2.2.2.15](#)) is set.

@GetContent: A bit flag specifying whether to return the document stream of the document (1) or not (0).

@GetWebListForNormalization: A bit flag specifying whether to return the subsite of the site specified by **@DocWebId**. If this flag is set to 1, then this procedure MUST return a list of subsites in the **Subsite List Result Set** (section [3.1.5.20.1](#)).

@bGetContainingList: Specifies whether to return the event receivers information about the list (1) containing the requested document. If this flag is set to 1, then this procedure MUST return the **Event Receivers Result Set** (section [3.1.5.20.6](#)).

@bCheckout: Specifies whether the current user is requesting to **check out** the document. If this flag is set to 1, and the **@LooksLikeAttachmentFile** parameter is set to 1, then this stored procedure MUST determine whether the current user has sufficient permissions to check out the requested document as an attachment. The result of this is returned by the **Attachment State Result Set** (section [3.1.5.20.14](#)).

@GetCurrentMetaInfo: If this parameter is set to 1, then the **Document Version Metadata Result Set** (section [3.1.5.20.4](#)) MUST return the document's metadata in the **{MetaInfo}** column. If this parameter is not set to 1, then the result set MUST return NULL as the document's metadata in the **{MetaInfo}** column.

@GetLinkInfo: Specifies whether to return the link information about the requested document. If this flag is set to 1, then this procedure MUST return the **Link Info Single Doc Result Set** (section [3.1.5.20.2](#)).

@UserId: The **User Identifier** (section [2.2.1.1.13](#)) for the current user requesting the information.

@Version: Specifies the user interface (UI) version number of the document that is being requested. A value of -1 specifies the most recent version of the document.

@ChunkSize: Specifies the maximum size, in bytes, of the document content to be returned in the **{Content}** column in the **Document Information and Content (Read) Stream Result Set** (section [3.1.5.20.11](#)) and the **Document Version Information and Content Stream Result Set** (section [3.1.5.20.13](#)). For an uncustomized document, this MUST be NULL. Otherwise, if the data in the **{Content}** column is larger than the value specified in the **@ChunkSize** parameter, only the first **@ChunkSize** bytes MUST be returned, and the front-end Web server can request individual chunks of content in a subsequent request.

@MaxLevel: A **Publishing Level Type** (section [2.2.2.6](#)) value that indicates the maximum publishing level of the document to be returned in the **@Level** parameter if multiple levels of the document are available and the current user is not the owner of the draft or does not have the document checked out.

@StreamPartition: Specifies the stream partition of the document to fetch.

@Level: The **Publishing Level Type** value of the requested version of the document visible to the current user, returned as an output parameter. This value MUST be returned as NULL if the document does not exist.

@UIVersion: Output parameter. The user interface version number associated with the document. This value MUST be NULL in the case of a document that does not exist, or if the **@GetContent** flag is not 1.

@RequestGuid: The optional request identifier for the current request.

Return Values: This procedure returns an integer return code that MUST be in the following table.

| Value | Description |
|-------|------------------------------|
| 0 | Successful execution. |
| 3 | The document does not exist. |

This stored procedure returns a **Publishing Level Type** value in the parameters as described earlier. This stored procedure MUST return multiple result sets. Some of the result sets MUST NOT be returned depending upon input parameters or calculations performed in this stored procedure, and all result sets that are returned MUST be sent in the order defined as follows.

3.1.5.20.1 Subsite List Result Set

The **Subsite List Result Set** contains an unordered list of store-relative URLs for all subsites within the site collection whose parent site is specified in the **@DocWebId** parameter.

The **Subsite List Result Set** MUST only be returned if *@GetWebListForNormalization* is set to 1. The **Subsite List Result Set** MUST contain one row for each subsite with the specified parent site, and it MUST contain no rows if there are no such subsites.

The **Subsite List Result Set** is defined in the Common Result Sets **URL Result Set** (section [2.2.4.27](#)).

3.1.5.20.2 Link Info Single Doc Result Set

The **Link Info Single Doc Result Set** contains information about links to or within the requested document. Entries are present both for forward links and for backward links. The **Link Info Single Doc Result Set** MUST only be returned if *@GetLinkInfo* is set to 1, and MUST contain one row for each link that is referenced.

The **Link Info Single Doc Result Set** is defined in the Common Result Sets **Link Information Result Set** (section [2.2.4.13](#)).

3.1.5.20.3 Document Metadata Result Set

The **Document Metadata Result Set** contains the metadata about the most current version of the requested document visible to the current user.

The **Document Metadata Result Set** MUST only be returned if *@Version* is negative. There MUST be one row in the **Document Metadata Result Set** if the document exists; otherwise, there MUST be no rows.

The **Document Metadata Result Set** is defined in the Common Result Sets **Document Metadata Result Set** (section [2.2.4.8](#)).

3.1.5.20.4 Document Version Metadata Result Set

The **Document Version Metadata Result Set** contains the metadata about the requested version of the document.

The **Document Version Metadata Result Set** MUST only be returned if *@Version* is not negative. If the document exists, the **Document Version Metadata Result Set** MUST contain one row; otherwise, it MUST contain zero rows.

The **Document Version Metadata Result Set** is defined in section **Document Version Metadata Result Set** (section [2.2.4.9](#)), located in the Common Result Sets (section [2.2.4](#)).

3.1.5.20.5 NULL Result Set

The **NULL Result Set** is a placeholder that returns no data.

The **NULL Result Set** MUST only be returned if *@Version* is negative, the requested document exists, and *@DocWebId* is NULL. The **NULL Result Set** MUST contain zero rows in a schema containing a single unnamed column.

3.1.5.20.6 Event Receivers Result Set

The **Event Receivers Result Set** contains information about the event receivers defined for this document.

The **Event Receivers Result Set** MUST only be returned if one of these conditions is true:

- The requested document exists and either *@Version* is not negative, OR
- *@Version* is negative and *@DocWebId* is not NULL

The **Event Receivers Result Set** MUST contain one row for each event receiver registered with an **Event Host Type** (section [2.2.1.2.5](#)) of 3 (list item) for this document.

The **Event Receivers Result Set** is defined in the Common Result Sets **Event Receivers Result Set** (section [2.2.4.11](#)).

3.1.5.20.7 List Metadata Result Set

The **List Metadata Result Set** contains the metadata associated with the list (1) that contains the requested document.

The **List Metadata Result Set** MUST only be returned if the *@bGetContainingList* parameter is set to 1 and the document is contained within a list. The **List Metadata Result Set** MUST contain one row.

The **List Metadata Result Set** is defined in the Common Result Sets **List Metadata Result Set** (section [2.2.4.14](#)).

3.1.5.20.8 Empty List Result Set

The **Empty List Result Set** contains a single, unnamed column with no rows to indicate that the document is not contained within a list. The **Empty List Result Set** MUST only be returned if the *@bGetContainingList* parameter is set to 1 and the document is not contained within a list.

The **Empty List Result Set** is defined in the Common Result Sets **Empty Result Set** (section [2.2.4.10](#)).

3.1.5.20.9 Event Receivers Result Set (1)

The **Event Receivers Result Set** contains the event receivers associated with the list (1) that contains the requested document.

The **Event Receivers Result Set** MUST only be returned if the *@bGetContainingList* parameter is set to 1 and the document is contained within a list. The **Event Receivers Result Set** MUST contain one row for each event receiver registered with an **Event Host Type** (section [2.2.1.2.5](#)) of 2 (List) for the List.

The **Event Receivers Result Set** is defined in the Common Result Sets **Event Receivers Result Set** (section [2.2.4.11](#)).

3.1.5.20.10 Document Information and Content (Read) Metadata Result Set

This result set contains metadata about the document stream for the requested document.

This result set MUST only be returned if *@GetContent* is set to 1 and *@Version* is negative. If the document exists, it MUST contain one row; otherwise, it MUST contain zero rows.

The value returned for the **{HistVersion}** column MUST be 0.

This result set is defined as **Document Content Metadata Result Set** (section [2.2.4.6](#)) in the list of Common Result Sets (section [2.2.4](#)).

3.1.5.20.11 Document Information and Content (Read) Stream Result Set

This result set contains a row for each of the document's stream binary pieces. This result set MUST only be returned if `@GetContent` is set to "1" and `@Version` is negative.

This result set MUST return zero or more rows. If the requested document is an uncustomized document, this result set MUST contain 0 rows.

This result set is defined as **Document Content Stream Result Set** (section [2.2.4.7](#)) in the Common Result Sets (section [2.2.4](#)).

3.1.5.20.12 Document Version Information and Content Result Set

This result set contains metadata about the document stream for the requested document.

This result set MUST only be returned if `@GetContent` is set to 1 and `@Version` is not negative. If the document exists, it MUST contain one row; otherwise, it MUST contain zero rows.

The value returned for the **{HistVersion}** column MUST be the UI version of the requested document version.

This result set is defined as **Document Content Metadata Result Set** (section [2.2.4.6](#)) in the list of Common Result Sets (section [2.2.4](#)).

3.1.5.20.13 Document Version Information and Content Stream Result Set

This result set contains a row for each of the document's stream binary pieces. This result set MUST only be returned if `@GetContent` is set to 1 and `@Version` is not negative.

This result set MUST return zero or more rows.

This result set is defined as **Document Content Stream Result Set** (section [2.2.4.7](#)) in the Common Result Sets (section [2.2.4](#)).

3.1.5.20.14 Attachment State Result Set

The **Attachment State Result Set** contains the information about the attachment state of the requested document. The **Attachment State Result Set** MUST be returned and MUST contain one row.

The **Attachment State Result Set** is defined using T-SQL syntax, as follows.

```
{IsAttachment}          bit,  
{NeedManageListRight}  bit,  
{Level}                 tinyint,
```

{IsAttachment}: This specifies whether the document is associated with an attachment. This value MUST be 1 if the document is an attachment, a list item attachment folder, or the list attachment folder itself. Otherwise, this value MUST be 0. See **Attachments Flag** (section [2.2.1.2.1](#)) for more information.

{NeedManageListRight}: This specifies whether operations on this document require the user to have the **ManageLists** bit of the **WSS Rights Mask** set (section [2.2.2.15](#)). This value MUST be 0 if the document is not stored in a list.

{Level}: A **Publishing Level Type** (section [2.2.2.6](#)) value specifying the publishing status of the document. This value MUST be NULL if the document does not exist.

3.1.5.20.15 Audit Mask Result Set

The **Audit Mask Result Set** contains the information about the **Audit Flags** associated with this document. The **Audit Mask Result Set** MUST be returned and MUST contain a single row of data if the document exists.

The **Audit Mask Result Set** is defined in the Common Result Sets Site **Audit Mask Result Set** (section [2.2.4.22](#)).

3.1.5.21 proc_FetchDocForUpdate

The **proc_FetchDocForUpdate** stored procedure requests document content and metadata information. It also updates the **CacheParseId** flag for the requested document if the *@CacheParse* parameter is set to 1.

```
PROCEDURE proc_FetchDocForUpdate (
    @DocSiteId                uniqueidentifier,
    @DocWebId                 uniqueidentifier,
    @DocDirName               nvarchar (256),
    @DocLeafName              nvarchar (128),
    @UserId                   int,
    @Version                  int,
    @GetContent                bit,
    @GetWebListForNormalization bit,
    @CacheParse                bit,
    @GetWebPartInfo            bit,
    @GetFileFormatInfo         bit,
    @bGetContainingList        bit,
    @GetCurrentMetaInfo        bit,
    @LooksLikeAttachmentFile   bit,
    @ChunkSize                 int,
    @StreamPartition           tinyint,
    @Level                     tinyint          OUTPUT,
    @RequestGuid               uniqueidentifier = NULL OUTPUT
);
```

@DocSiteId: The Site Collection Identifier (section [2.2.1.1.9](#)) of the site collection containing the requested document.

@DocWebId: The Site Identifier (section [2.2.1.1.11](#)) of the site (2) containing the requested document.

@DocDirName: The directory name of the requested document.

@DocLeafName: The leaf name of the requested document.

@UserId: The User Identifier (section [2.2.1.1.13](#)) for the current user requesting the information.

@Version: Specifies the user interface (UI) version number of the document being requested. A value of -1 specifies the most recent version of the document.

@GetContent: A bit flag specifying whether or not to return the document stream of the document. This flag MUST be set to 1 for to return either the **Document Information and Content Result**

Set (section [3.1.5.21.14](#)), the **Document Version 1 Information and Content Result Set** (section [3.1.5.21.16](#)), or the **Document Version 2 Information and Content Result Set** (section [2](#)).

@GetWebListForNormalization: A bit flag specifying whether to return the subsite of the site specified by **@DocWebId**. If this flag is set to 1, then **proc_FetchDocForUpdate** MUST return a list of child sites in the **Subsite List Result Set** (section [3.1.5.21.1](#)).

@CacheParse: A bit flag specifying whether to update the **CacheParseId** flag of the requested document. If this flag is set to 1, then **proc_FetchDocForUpdate** MUST update the **CacheParseId** flag in the **Docs View** (section [2.2.6.3](#)) for the requested document.

@GetWebPartInfo: A bit flag specifying whether to return the Web Parts information for the requested document. If this flag is set to 1, then **proc_FetchDocForUpdate** MUST return the Web Parts information for the requested document in the Web Part Info Result Set (section [3.1.5.21.8](#)) and the **Zone ID Result Set** (section [3.1.5.21.9](#)).

@GetFileFormatInfo: If this parameter is set to NULL or 1, then the **File Format Metadata Result Set** (section [3.1.5.21.10](#)) MUST be returned. Otherwise, the **File Format Metadata Result Set** MUST NOT be returned.

@bGetContainingList: Specifies whether to return the event receivers information about the list containing the requested document. If this flag is set to 1, then this procedure MUST return the **Event Receivers Result Set** (section [3.1.5.21.6](#)) for the list.

@GetCurrentMetaInfo: If this parameter is set to 1, then the **Document Version Metadata Result Set** (section [3.1.5.21.4](#)) MUST return the document's metadata in the **{MetaInfo}** column. If this parameter is not set to 1, then the Result Set MUST return NULL as the document's metadata in the **{MetaInfo}** column.

@LooksLikeAttachmentFile: Specifies whether the requested document appears to the front-end Web server to be an attachment to a list item. If this flag is set to 1, then this procedure MUST determine whether the current user has sufficient permissions to retrieve the requested document as an attachment. In addition, if this flag is set to 1, then the **NeedManageListRight** column of the **Attachment State Result Set** (section [3.1.5.21.18](#)) will indicate if the **ManageLists** bit of the **WSS Rights Mask** (section [2.2.2.15](#)) is set.

@ChunkSize: Specifies the maximum size, in bytes, of the document content to be returned in the **{Content}** column in the **Document Information and Content (Update) Stream Result Set** and the **Document Version Information and Content Stream Result Set**. For an uncustomized document, this MUST be NULL. Otherwise, if the data in the **{Content}** column is larger than the value specified in the **@ChunkSize** parameter, only the first **@ChunkSize** bytes MUST be returned, and the front-end Web server can request individual chunks of content in a subsequent request.

@StreamPartition: Specifies the stream partition of the document to fetch.

@Level: The **Publishing Level Type** (section [2.2.2.6](#)) value of the requested version of the document visible to the current user, returned as an output parameter. This value MUST be returned as NULL if the document does not exist.

@RequestGuid: The optional request identifier for the current request.

Return Values: This procedure MUST return an integer return code of 0.

This procedure returns a **Publishing Level Type** value in the parameters as specified earlier. This procedure MUST return multiple result sets. Some of the result sets MUST NOT be returned,

depending upon input parameters or calculations performed in this procedure, and all result sets that are returned MUST be sent in the order defined as follows.

3.1.5.21.1 Subsite List Result Set

The **Subsite List Result Set** contains an unordered list of store-relative URLs for all subsites within the site collection whose parent site (2) is specified in the *@DocWebId* parameter.

The **Subsite List Result Set** MUST only be returned if *@GetWebListForNormalization* is set to 1. The **Subsite List Result Set** MUST contain one row for each subsite within the specified parent Site, and MUST contain zero rows if there are no such subsites.

The **Subsite List Result Set** is defined in the Common Result Sets **URL Result Set** (section [2.2.4.27](#)).

3.1.5.21.2 ACL and Permission Result Set

The **ACL and Permission Result Set** contains information about the permissions associated with the security scope in effect for the document. The **ACL and Permission Result Set** MUST be returned and MUST contain one row. If the document does not exist, then the values of both columns MUST be NULL. The **ACL and Permission Result Set** is defined in the Common Result Sets **ACL and Permission Result Set** (section [2.2.4.1](#)).

3.1.5.21.3 Document Metadata Result Set

The **Document Metadata Result Set** contains the metadata about the most current version of the requested document visible to the current user.

The **Document Metadata Result Set** MUST only be returned if *@Version* is negative. If the document exists, the **Document Metadata Result Set** MUST contain one row; otherwise, it MUST contain zero rows.

The **Document Metadata Result Set** is defined in the in the Common Result Sets **Document Metadata Result Set** (section [2.2.4.8](#)).

3.1.5.21.4 Document Version Metadata Result Set

The **Document Version Metadata Result Set** contains the metadata about the requested version of the document.

The **Document Version Metadata Result Set** MUST only be returned if *@Version* is not negative. If the document exists, the **Document Version Metadata Result Set** MUST contain one row; otherwise, it MUST contain zero rows.

The **Document Version Metadata Result Set** is in section **Document Version Metadata Result Set** (section [2.2.4.9](#)), located in the Common Result Sets (section [2.2.4](#)).

3.1.5.21.5 NULL Result Set

The **NULL Result Set** is a placeholder that returns no data.

The **NULL Result Set** MUST only be returned if *@Version* is negative, the requested document exists, and *@DocWebId* is NULL. The NULL Result Set MUST contain zero rows in a schema containing a single unnamed column.

3.1.5.21.6 Event Receivers Result Set

The **Event Receivers Result Set** contains information about the event receivers defined for this document.

The **Event Receivers Result Set** MUST only be returned if the requested document exists in the site specified by *@DocWebId*. The **Event Receivers Result Set** MUST contain one row for each event receiver registered with an **Event Host Type** (section [2.2.1.2.5](#)) of 3 (list item) for this document.

The result set is defined in the Common Result Sets **Event Receivers Result Set** (section [2.2.4.11](#)).

3.1.5.21.7 Link Info Single Doc Fixup Result Set

The **Link Info Single Doc Fixup Result Set** contains information about forward links within the requested document. The **Link Info Single Doc Fixup Result Set** MUST only be returned if Link information was requested by setting *@CacheParse* to 1.

| | |
|---------------|-------------------|
| LinkDirName | nvarchar(256), |
| LinkLeafName | nvarchar(128), |
| LinkType | tinyint, |
| LinkSecurity | tinyint, |
| LinkDynamic | tinyint, |
| LinkServerRel | bit, |
| LinkStatus, | tinyint, |
| PointsToDir | bit, |
| WebPartId | uniqueidentifier, |
| LinkNumber | int, |
| WebId | uniqueidentifier, |
| Search | nvarchar(max), |
| FieldId | uniqueidentifier; |

LinkDirName: Contains the directory name of the link.

LinkLeafName: Contains the leaf name of the link.

LinkType: The **LinkType** value of the link in the specified document.

LinkSecurity: A **LinkSecurity** value specifying whether the scheme of the link is HTTP or HTTPS.

LinkDynamic: A **LinkDynamic** value that specifies whether this link is one of several special link types.

LinkServerRel: MUST be 1 to indicate that the link URL is a server-relative URL. Otherwise, MUST be 0 to indicate that the link URL is not a server-relative URL.

LinkStatus: A **Document Store Type** indicating the type of document the link points to. If the link is a forward link for a document that doesn't exist, then this MUST be NULL. This value MUST be NULL if this link entry refers to a location that exists outside the site collection where the document is stored, or if it refers to a location that could not be verified. See **Document Store Type** (section [2.2.2.4](#)) for a list of valid values.

PointsToDir: If the link pointed to a directory where a welcome page existed (such as pointing to http://server when a welcome page like http://server/default.aspx existed), then the link is automatically changed to be the URL to the welcome page itself. This bit MUST be set to 1 if this

operation has been performed so that it can be distinguished from an explicit link to the welcome page.

WebPartId: If this link corresponds to a Web Part within a Web Part zone, which is therefore logically part of this document, but not present in the HTML source code of this document, then this is the GUID of the Web Part to which the link belongs.

LinkNumber: An ordinal value denoting the relative order of the link within the source of the document, Web Part, or field (2) being processed.

WebId: MUST be NULL.

Search: MUST be NULL.

FieldId: If the link is for a list item field (2) within this document, this is the GUID of the field to which the link belongs.

3.1.5.21.8 Web Part Info Result Set

The **Web Part Info Result Set** MUST only be returned when *@GetWebPartInfo* is set to 1. If Web Part data for the requested document exists, one row MUST be returned for each Web Part, otherwise zero rows MUST be returned.

| | |
|------------------------------------|--------------------------------|
| <code>tp_Id</code> | <code>uniqueidentifier,</code> |
| <code>tp_Level</code> | <code>tinyint,</code> |
| <code>tp_Source</code> | <code>nvarchar(max),</code> |
| <code>tp_AllUsersProperties</code> | <code>varbinary(max);</code> |

tp_Id: The Web Part Identifier of the Web Part.

tp_Level: **Publishing Level Type** value of the document.

tp_Source: Properties of the Web Part.

tp_AllUsersProperties: A list of the XML properties which are common for all users of the Web Part.

3.1.5.21.9 Zone ID Result Set

The **Zone ID Result Set** returns a list of **Web Part zone identifiers**. The **Zone ID Result Set** MUST only be returned when *@GetWebPartInfo* is set to 1. If Web Part data for the requested document exists, one row MUST be returned for each Web Part zone; otherwise zero rows MUST be returned.

| | |
|------------------------|----------------------------|
| <code>tp_ZoneID</code> | <code>nvarchar(64);</code> |
|------------------------|----------------------------|

tp_ZoneID: The Web Part zone identifier.

3.1.5.21.10 File Format Metadata Result Set

The **File Format Metadata Result Set** returns metadata information about the format of the content of the document. This result set MUST only be returned if the *@GetFileFormatInfo* parameter is set to NULL or 1.

| | |
|------------------------|-----------------|
| FileFormatMetaInfo | varbinary(max), |
| FileFormatMetaInfoSize | int |
| FFMConsistent | bit |

@FileFormatMetaInfo: This contains metadata about the format of the content of the document that is to be updated. This can be NULL.

@FileFormatMetaInfoSize: Size in bytes of the metadata returned by the *@FileFormatMetaInfo* column. This MUST be 0 if the *@FileFormatMetaInfo* is NULL.

@FFMConsistent: A bit flag specifying whether the file format metadata info is in a consistent state (1) or not (0).

3.1.5.21.11 List Metadata Result Set

The **List Metadata Result Set** contains the metadata associated with the list containing the requested document.

The **List Metadata Result Set** MUST only be returned if the *@bGetContainingList* parameter is set to 1 and the document is contained within a list. The **List Metadata Result Set** MUST contain one row.

The **List Metadata Result Set** is defined in the Common Result Sets **List Metadata Result Set** (section [2.2.4.14](#)).

3.1.5.21.12 Empty List Result Set

The **Empty List Result Set** contains a single unnamed column with no rows to indicate the document is not contained within a List. The **Empty List Result Set** MUST only be returned if the *@bGetContainingList* parameter is set to 1 and the document is not contained within a List.

The **Empty List Result Set** is defined in the Common Result Sets **Empty Result Set** (section [2.2.4.10](#)).

3.1.5.21.13 Event Receivers Result Set (1)

The **Event Receivers Result Set** contains the event receivers associated with the List which contains the requested document.

The **Event Receivers Result Set** MUST only be returned if the *@bGetContainingList* parameter is set to 1 and the document is contained within a List. There MUST be one row in the **Event Receivers Result Set** for each event receiver registered with an **Event Host Type** (section [2.2.1.2.5](#)) of 2 (List) for the List.

The **Event Receivers Result Set** is defined in the Common Result Sets **Event Receivers Result Set** (section [2.2.4.11](#)).

3.1.5.21.14 Document Information and Content (Update) Metadata Result Set

This result set contains metadata about the document stream for the current version of the requested document.

This result set MUST only be returned if *@GetContent* is set to 1 and *@Version* is negative. If the publishing level of the document specified by *@Level* exists, this result set MUST contain one row; otherwise, this result set MUST contain no rows.

The value returned for the **{HistVersion}** column MUST be 0.

This result set is defined as **Document Content Metadata Result Set** (section [2.2.4.6](#)) in the Common Result Sets (section [2.2.4](#)).

3.1.5.21.15 Document Information and Content (Update) Stream Result Set

This result set contains a row for each of the document's stream binary pieces. This result set MUST only be returned if *@GetContent* is set to 1 and *@Version* is negative.

This result set MUST return zero or more rows. If the requested document is an uncustomized document, this result set MUST contain zero rows.

This result set is defined by the **Document Content Stream Result Set** (section [2.2.4.7](#)) in the Common Result Sets (section [2.2.4](#)).

3.1.5.21.16 Document Version Information and Content (Update) Metadata Result Set

This result set contains information about the metadata for the document stream for the requested version of the document.

This result set MUST only be returned if *@GetContent* is set to 1 and *@Version* is not negative, and the document exists with the publishing level specified by *@Level* and with the user interface (UI) version specified by *@Version*.

This result set MUST contain one row if it is returned. The value returned for the **{HistVersion}** column MUST be the user interface (UI) version of the requested version of the document.

This result set is defined by the **Document Content Metadata Result Set** (section [2.2.4.6](#)) in the Common Result Sets (section [2.2.4](#)).

3.1.5.21.17 Document Version Information and Content (Update) Stream Result Set

This result set contains a row for each of the document's stream binary pieces.

This result set MUST only be returned if *@GetContent* is set to 1 and *@Version* is not negative, and the document exists with the publishing level specified by *@Level* and with the user interface (UI) version specified by *@Version*.

This result set MUST contain zero or more rows.

This result set is defined by the **Document Content Stream Result Set** (section [2.2.4.7](#)) in the Common Result Sets (section [2.2.4](#)).

3.1.5.21.18 Attachment State Result Set

The **Attachment State Result Set** contains the information about the attachment state of the requested document. The **Attachment State Result Set** MUST be returned and MUST contain one row.

The **Attachment State Result Set** is defined using T-SQL syntax, as follows.

```
{IsAttachment}          bit,  
{NeedManageListRight}  bit,
```

{Level} tinyint,

{IsAttachment}: This specifies whether the document is associated with an attachment. This value **MUST** be 1 if the document is an attachment, a list item attachment folder, or the list attachment folder itself. Otherwise, this value **MUST** be 0. See **Attachments Flag** (section [2.2.1.2.1](#)) for more information.

{NeedManageListRight}: This specifies whether operations on this document require the user to have the **ManageLists** bit of the **WSS Rights Mask** set (section [2.2.2.15](#)). This value **MUST** be 0 if the document is not stored in a list.

{Level}: A **Publishing Level Type** (section [2.2.2.6](#)) value specifying the publishing status of the document. This value **MUST** be NULL if the document does not exist.

3.1.5.22 **proc_FetchWelcomeNames**

The **proc_FetchWelcomeNames** stored procedure lists all the names of the default welcome pages used as redirection targets when folders are requested by an HTTP GET in all site collections in the back-end database server.

```
PROCEDURE proc_FetchWelcomeNames (  
    @RequestGuid uniqueidentifier = NULL OUTPUT  
);
```

@RequestGuid: The optional request identifier for the current request.

Return Values: The **proc_FetchWelcomeNames** stored procedure **MUST** return an integer return code of 0.

The **proc_FetchWelcomeNames** stored procedure **MUST** return one result set.

3.1.5.22.1 **Welcome Pages Result Set**

The **Welcome Pages Result Set** returns the list of configured default welcome page names, with one row for each configured welcome page name.

```
LeafName nvarchar(128);
```

LeafName: A string containing the configured welcome page name in leaf name format; for example, "default.aspx", "default.htm".

3.1.5.23 **proc_GenerateNextId**

The **proc_GenerateNextId** stored procedure returns an identifier to be used for a new list item in a specified list, and to increment the value of the identifier returned by the next call to this procedure for the same List.

```
PROCEDURE proc_GenerateNextId (  
    @SiteId uniqueidentifier,  
    @ListId uniqueidentifier,  
    @NumIds int = 1,  
    @RequestGuid uniqueidentifier = NULL OUTPUT
```

```
);
```

@SiteId: The Site Collection Identifier (section [2.2.1.1.9](#)) of the site collection containing the List.

@ListId: The List Identifier (section [2.2.1.1.5](#)) of the List.

@NumIds: **proc_GenerateNextId** MUST increment the value of the list item identifier returned by the next call by this value. This value MUST be a positive number (greater than zero). If the parameter is not provided, 1 is used.

@RequestGuid: The optional request identifier for the current request.

Return Values: This procedure returns a positive integer return code, which is the available list item Identifier for the specified List. This procedure MUST NOT return a result set.

3.1.5.24 **proc_GetAllRolesForUser**

The **proc_GetAllRolesForUser** stored procedure retrieves the role identifiers for the roles assigned to a set of principals in a given security scope.

```
PROCEDURE proc_GetAllRolesForUser (  
    @SiteId uniqueidentifier,  
    @ScopeId uniqueidentifier,  
    @PrincipalIdsCsv nvarchar(max),  
    @RequestGuid uniqueidentifier = null OUTPUT,  
);
```

@SiteId: The site collection identifier of the site collection containing the List

@ScopeId: The scope identifier of the security scope for which roles are to be returned.

@PrincipalIdsCsv: The principal identifiers for which roles are to be returned. This parameter MUST be an **nvarchar(max)** which conforms to the following **ABNF**:

```
PrincipalIdsCsv = #PrincipalId  
PrincipalId = 1*DIGIT
```

Each **PrincipalId** MUST be greater than 0 and less than 2,147,483,648 when interpreted as a decimal integer.

@RequestGuid: The optional request identifier for the current request.

Result Sets:

This procedure MUST return the **User Roles Result Set**.

3.1.5.24.1 **User Roles Result Set**

```
RoleId int NOT NULL,
```

RoleId: A role identifier assigned to one or more of the principal identifiers specified by the PrincipalId listed by the **@PrincipalIdsCsv** parameter.

3.1.5.25 proc_GetAuditMask

The **proc_GetAuditMask** stored procedure is invoked to identify **Audit Flags** (section [2.2.2.1](#)) information for a specified object (a page, file, document, or site collection).

```
PROCEDURE proc_GetAuditMask(  
    @ItemType                tinyint,  
    @SiteId                  uniqueidentifier,  
    @DirName                  nvarchar(256),  
    @LeafName                 nvarchar(128),  
    @RequestGuid              uniqueidentifier = NULL OUTPUT  
);
```

@ItemType: The **Audit Item Type** of the object.

@SiteId: The Site Collection Identifier for the site collection containing the object. This is used to get the global audit mask.

@DirName: The directory name of the object.

@LeafName: The leaf name of the object.

@RequestGuid: The optional request identifier for the current request.

Return Values: The **proc_GetAuditMask** stored procedure returns an integer return code, which **MUST** be listed in the following table.

| Value | Description |
|-------|---|
| 0 | Successful execution. |
| 2 | An object of the specified Audit Item Type could not be found at the specified location. |

The **proc_GetAuditMask** stored procedure **MUST** return one result set.

3.1.5.25.1 Audit Mask Result Set

The **Audit Mask Result Set** contains the context-sensitive identifier for the specified object, and the **Audit Flags** set (section [2.2.2.1](#)) and inherited on that object. The **Audit Mask Result Set** **MUST** be returned and **MUST** contain a single row. The **Audit Mask Result Set** is defined in the Common Result Sets Site **Audit Mask Result Set** (section [2.2.4.22](#)).

3.1.5.26 proc_GetAuditMaskOutput

The **proc_GetAuditMaskOutput** stored procedure is invoked to get **Audit Flags** (section [2.2.2.1](#)) information about an object (a page, file, document, or site collection).

```
PROCEDURE proc_GetAuditMaskOutput(  
    @ItemType                tinyint,  
    @SiteId                  uniqueidentifier,  
    @DirName                  nvarchar(256),  
    @LeafName                 nvarchar(128),  
    @Id                      uniqueidentifier          OUTPUT,  
    @AuditFlags               int                      OUTPUT,  
    @InheritAuditFlags        int                      OUTPUT,  
    @GlobalAuditMask          int                      OUTPUT,  
);
```

```

        @RequestGuid                uniqueidentifier = NULL        OUTPUT
    );

```

@ItemType: The **Audit Item Type** (section [2.2.1.2.2](#)) of the object.

@SiteId: A **Site Collection Identifier** (section [2.2.1.1.9](#)) for the site collection containing the object. This is used to get the global audit mask information.

@DirName: The directory name of the object.

@LeafName: The leaf name of the object.

@Id: A document identifier (2) identifying the object, returned as an output parameter.

@AuditFlags: An **Audit Flags** value of the operations to be audited which are set directly on the specified object, returned as an output parameter.

@InheritAuditFlags: An **Audit Flags** value of the operations to be audited on the specified object which are inherited from its containing list (1), site (2), or site collection, returned as an output parameter.

@GlobalAuditMask: An **Audit Flags** value of the operations to be audited on the specified object which are inherited from the specified site collection, returned as an output parameter.

@RequestGuid: The optional request identifier for the current request.

Return Values: The **proc_GetAuditMaskOutput** stored procedure returns an integer return code, which **MUST** be listed in the following table.

| Value | Description |
|-------|---|
| 0 | Successful execution. |
| 2 | An object of the specified Audit Item Type could not be found at the specified location. |

The **proc_GetAuditMaskOutput** stored procedure **MUST** return no result sets.

3.1.5.27 proc_GetContainingList

The **proc_GetContainingList** stored procedure is invoked to get metadata and event receiver information about the list containing a specified URL.

```

PROCEDURE proc_GetContainingList(
    @SiteId                uniqueidentifier,
    @WebId                 uniqueidentifier,
    @Url                   nvarchar(260),
    @RequestGuid           uniqueidentifier = NULL OUTPUT
);

```

@SiteId: The Site Collection Identifier (section [2.2.1.1.9](#)) of the site collection containing the list.

@WebId: The Site Identifier (section [2.2.1.1.11](#)) of the site containing the list.

@Url: The URL in store-relative form of a list item or document within the list. The URL is used to derive the location of the containing list. The leaf name part of this parameter is ignored because it could point to a nonexistent document or list item.

@RequestGuid: The optional request identifier for the current request.

Return Values: This stored procedure returns an integer return code which **MUST** be listed in the following table.

| Value | Description |
|-------|---|
| 0 | Successful execution. |
| 1 | The list was found in a different site other than that specified by the <i>@WebId</i> parameter or the site specified by the <i>@WebId</i> parameter was not found. |
| 3 | The list does not exist in the site that was specified by the <i>@WebId</i> parameter. |

This stored procedure **MUST** return one result set if the containing list was not found, and **MUST** return two result sets if the containing list was found, as defined in the following sections.

3.1.5.27.1 List Metadata Result Set

The **List Metadata Result Set** contains the metadata associated with the list containing the value in the *@Url* parameter.

The **List Metadata Result Set** **MUST** only be returned if a containing list is found for the value for the *@Url* parameter and **MUST** contain one row.

This result set is defined in section **List Metadata Result Set** (section [2.2.4.14](#)), which can be found in the Common Result Sets (section [2.2.4](#)).

3.1.5.27.2 Empty Result Set

The **Empty Result Set** **MUST** only be returned if a containing list is not found for the value in the *@Url* parameter.

This result set is defined in section **Empty Result Set** (section [2.2.4.10](#)), which can be found in the Common Result Sets (section [2.2.4](#)).

3.1.5.27.3 Event Receivers Result Set

The **Event Receivers Result Set** contains information about the event receivers defined for the list that contains the value in the *@Url* parameter.

The **Event Receivers Result Set** **MUST** only be returned if a containing list is found for the value in the *@Url* parameter. This result set **MUST** contain one row for each event receiver registered with an Event Host Type (section [2.2.1.2.5](#)) of 2 for the List.

This result set is defined in **Event Receivers Result Set** (section [2.2.4.11](#)), which can be found in the Common Result Sets (section [2.2.4](#)).

3.1.5.28 proc_GetContainingListCore

The **proc_GetContainingListCore** stored procedure is invoked to get metadata and event receiver information about the list containing a specified URL.

```

PROCEDURE proc_GetContainingListCore (
    @SiteId                uniqueidentifier,
    @WebId                 uniqueidentifier,
    @Url                   nvarchar(260),
    @bReturnListMetadata  bit,
    @ListId                uniqueidentifier OUTPUT,
    @BaseType              int = NULL OUTPUT,
    @ExcludedType          int = NULL OUTPUT,
    @ListFlags             bigint = NULL OUTPUT,
    @bNeedNoThrottle       bit = NULL OUTPUT,
    @ItemCount             int = NULL OUTPUT
);

```

@SiteId: The **Site Collection Identifier** (section [2.2.1.1.9](#)) of the site collection containing the list.

@WebId: The **Site Identifier** (section [2.2.1.1.11](#)) of the site containing the list.

@Url: The store-relative form URL of a list item or document within the list. The URL is used to derive the location of the containing list. The leaf name part of **@Url** is ignored, since it could point to a nonexistent document or list item.

@bReturnListMetadata: Specifies whether the **List Metadata Result Set** (section [3.1.5.28.1](#)) returned by this stored procedure contains any rows. When this parameter is set to 0, the result set **MUST** be empty.

@ListId: An output parameter that specifies the **List Identifier** (section [2.2.1.1.5](#)) of the list that contains the specified URL. If the containing list was not found, this parameter **MUST** be NULL.

@BaseType: An output parameter that specifies the **List Base Type** (section [2.2.1.2.11](#)) of the list that contains the specified URL. If the containing list was not found, this parameter **MUST** be NULL.

@ExcludedType: An output parameter that specifies whether the specified URL is within a special folder type in the containing list. The parameter **MUST** be set to one the following values.

| Value | Description |
|-------|--|
| 0 | The document location is not contained in a special folder. |
| 1 | The document location is, or is contained within, a forms folder: a folder named "Forms" within a document library. |
| 2 | The document location is, or is contained within, a Web image folder: a folder named "_w" within a document library. |
| 3 | The document location is, or is contained within, a thumbnail folder: a folder named "_t" within a document library. |
| 4 | The document location is at the root folder of the list or document library. |

@ListFlags: An output parameter that specifies the **List Flags** (section [2.2.2.5](#)) of the list that contains the specified URL. If the containing list was not found, this parameter **MUST** be NULL.

@bNeedNoThrottle: An output parameter that specifies whether the list is exempt from resource throttling operations. If the containing list was not found, this parameter **MUST** be NULL.

@ItemCount: An output parameter that specifies the number of list items that are stored within the list that contains the specified URL. If the containing list was not found, this parameter MUST be NULL.

Return Values: This stored procedure returns an integer return code which MUST be listed in the following table.

| Value | Description |
|-------|---|
| 0 | Successful execution. |
| 1 | The list was found in a different site other than that specified by the @WebId parameter or the site specified by the @WebId parameter was not found. |
| 3 | The list does not exist in the site that was specified by the @WebId parameter. |

This stored procedure MUST return one result set, as defined following.

3.1.5.28.1 List Metadata Result Set

The **List Metadata Result Set** contains the metadata associated with the list containing the value in the @Url parameter.

The **List Metadata Result Set** MUST be returned if a containing list is found for the value for the @Url parameter and the @bReturnListMetadata parameter is set to 1. The **List Metadata Result Set** MUST contain one row.

This result set is defined in section **List Metadata Result Set** (section [2.2.4.14](#)), which can be found in the Common Result Sets (section [2.2.4](#)).

3.1.5.28.2 Empty Result Set

The **Empty Result Set** MUST be returned if a containing list is not found for the value in the @Url parameter, or if the @bReturnListMetadata parameter is set to 0.

This result set is defined in section **Empty Result Set** (section [2.2.4.10](#)), which can be found in the Common Result Sets (section [2.2.4](#)).

3.1.5.29 proc_GetDocsMetaInfo

The **proc_GetDocsMetaInfo** stored procedure is invoked to request document metadata information for up to ten documents within a specified site (2).

```

PROCEDURE proc_GetDocsMetaInfo(
    @DocSiteId                uniqueidentifier,
    @WebFullUrl                nvarchar(260),
    @GetDocsFlags              int,
    @UserId                    int,
    @DirName1                  nvarchar(256)          = NULL,
    @LeafName1                 nvarchar(128)           = NULL,
    @AttachmentsFlag1          tinyint                 = NULL,
    @Level1                    tinyint                 = NULL,
    @DirName2                  nvarchar(256)          = NULL,
    @LeafName2                 nvarchar(128)           = NULL,
    @AttachmentsFlag2          tinyint                 = NULL,
    @Level2                    tinyint                 = NULL,

```



```

@DirName3          nvarchar(256)      = NULL,
@LeafName3         nvarchar(128)       = NULL,
@AttachmentsFlag3  tinyint           = NULL,
@Level3           tinyint           = NULL,
@DirName4          nvarchar(256)      = NULL,
@LeafName4         nvarchar(128)       = NULL,
@AttachmentsFlag4  tinyint           = NULL,
@Level4           tinyint           = NULL,
@DirName5          nvarchar(256)      = NULL,
@LeafName5         nvarchar(128)       = NULL,
@AttachmentsFlag5  tinyint           = NULL,
@Level5           tinyint           = NULL,
@DirName6          nvarchar(256)      = NULL,
@LeafName6         nvarchar(128)       = NULL,
@AttachmentsFlag6  tinyint           = NULL,
@Level6           tinyint           = NULL,
@DirName7          nvarchar(256)      = NULL,
@LeafName7         nvarchar(128)       = NULL,
@AttachmentsFlag7  tinyint           = NULL,
@Level7           tinyint           = NULL,
@DirName8          nvarchar(256)      = NULL,
@LeafName8         nvarchar(128)       = NULL,
@AttachmentsFlag8  tinyint           = NULL,
@Level8           tinyint           = NULL,
@DirName9          nvarchar(256)      = NULL,
@LeafName9         nvarchar(128)       = NULL,
@AttachmentsFlag9  tinyint           = NULL,
@Level9           tinyint           = NULL,
@DirName10         nvarchar(256)      = NULL,
@LeafName10        nvarchar(128)       = NULL,
@AttachmentsFlag10 tinyint           = NULL,
@Level10          tinyint           = NULL,
@RequestGuid       uniqueidentifier   = NULL      OUTPUT
);

```

@DocSiteId: The site collection identifier for the site collection containing the specified documents.

@WebFullUrl: The store-relative URL of the site (2) containing the specified documents.

@GetDocsFlags: A bit mask with a flag that specifies whether to return link information. If this parameter has the bit 0x00000020 set, then link information **MUST** be returned in the **Link Info Result Set** (section [3.1.5.29.5](#)).

@UserId: The user identifier for the current user requesting the information.

The next four parameters are duplicated 10 times, with each set of parameters referring to a document to be fetched. Each instance of these individual parameter names is differentiated by a suffix with a value of 1 thru 10, which replaces the placeholder "#" symbol shown below.

@DirName#: The directory name of the specified document. A NULL value signifies that no document is being fetched in this slot, and the next three parameters **MUST** be ignored.

@LeafName#: The leaf name of the specified document. If **@DirName#** is not NULL, this **MUST NOT** be NULL.

@AttachmentsFlag#: An **Attachments Flag** (section [2.2.1.2.1](#)) value which specifies the type of security checks to be performed by **proc_GetDocsMetaInfo** based on whether it appears to be an attachment.

@Level#: A **Publishing Level Type** (section [2.2.2.6](#)) value specifying the maximum publishing level of the current version of the document to be returned to the front-end Web server if multiple current versions of the document are available.

@RequestGuid: The optional request identifier for the current request.

Return Values: The **proc_GetDocsMetaInfo** stored procedure returns an integer return code which MUST be 0.

The **proc_GetDocsMetaInfo** stored procedure MUST return multiple result sets:

3.1.5.29.1 Individual URL Security Result Set

The **Individual URL Security Result Set** contains security information about the specified document. The **Individual URL Security Result Set** to be used to check if the current user has permission to see this document's metadata. If the document does not exist, but the specified URL is within a list or document library, security information is returned from the security scope for the specified document location.

One **Individual URL Security Result Set** or **NULL Individual URL Security Result Set** MUST be returned for each document whose corresponding *@DirName#* parameter is not NULL. If all *@DirName#* parameters are set to NULL, **Individual URL Security Result Sets** MUST NOT be returned.

Each **Individual URL Security Result Set** MUST only be returned if the specified document location is contained within a List or document library. Otherwise, the **NULL Individual URL Security Result Set** (section [2.2.4.16](#)) MUST be returned instead. If returned, the **Individual URL Security Result Set** MUST contain a single row.

The result set is defined in the Common Result Sets **Individual URL Security Result Set** (section [2.2.4.12](#)).

3.1.5.29.2 NULL Individual Url Security Result Set

The **NULL Individual URL Security Result Set** indicates that the specified document location is not contained within a List or document library.

One **Individual URL Security Result Set** or **NULL Individual URL Security Result Set** MUST be returned for each document whose corresponding *@DirName#* parameter is not NULL. If all *@DirName#* parameters are set to NULL, **NULL Individual URL Security Result Sets** MUST NOT be returned.

Each **NULL Individual URL Security Result Set** MUST only be returned if the specified document location is not contained within a List or document library. Otherwise, the **Individual URL Security Result Set** (section [2.2.4.12](#)) MUST be returned instead. If returned, the **NULL Individual URL Security Result Set** MUST contain a single row.

The **NULL Individual URL Security Result Set** is defined in the Common Result Sets **NULL Individual URL Security Result Set** (section [2.2.4.16](#)).

3.1.5.29.3 Server Time Result Set

The **Server Time Result Set** returns the current time from the back-end database server in UTC. The **Server Time Result Set** MUST be returned. The **Server Time Result Set** MUST only contain a single row. The **Server Time Result Set** is defined in the Common Result Sets **Server Time Result Set** (section [2.2.4.20](#)).

3.1.5.29.4 Subsite List Result Set

The **Subsite List Result Set** contains an unordered list of store-relative form URLs for all subsites whose parent site is specified in the *@WebFullUrl* parameter.

The **Subsite List Result Set** MUST be returned. It MUST contain one row for each subsite with the specified parent Site, and MUST contain no rows if there are no such subsites.

The **Subsite List Result Set** is defined in the Common Result Sets **URL Result Set** (section [2.2.4.27](#)).

3.1.5.29.5 Link Info Result Set

The **Link Info Result Set** returns information about each forward link from, and each backward link to, the current version of the specified documents within the site collection. The **Link Info Result Set** MUST only be returned if link information was requested by the *@GetDocsFlags* parameter. The **Link Info Result Set** MUST contain one row per link for each specified document.

The **Link Info Result Set** MUST be ordered by the **DocId** column, and is defined in the Common Result Sets **Single Doc Link Information Result Set** (section [2.2.4.21](#)).

3.1.5.29.6 Multiple Document Metadata Result Set

The **Multiple Document Metadata Result Set** contains the metadata for the specified documents. This result set MUST contain one row for each document where the corresponding *@DirName#* parameter was not set to NULL, and the rows MUST be ordered by the **DocId** column.

| | |
|--------------------------|-------------------|
| DocId | uniqueidentifier, |
| {FullUrl} | nvarchar(260), |
| Type | tinyint, |
| MetaInfoTimeLastModified | datetime, |
| MetaInfo | varbinary(max), |
| Size | int, |
| TimeCreated | datetime, |
| TimeLastModified | datetime, |
| ETagVersion | int, |
| DocFlags | int, |
| {ListType} | int, |
| tp_Name | nvarchar(38), |
| {ListTitle} | nvarchar(255), |
| {CacheParseId} | uniqueidentifier, |
| GhostDirName | nvarchar(256), |
| GhostLeafName | nvarchar(128), |
| tp_Login | nvarchar(255), |
| CheckoutDate | datetime, |
| CheckoutExpires | datetime, |
| VirusStatus | int, |
| VirusInfo | nvarchar(255), |
| SetupPathVersion | tinyint, |
| SetupPath | nvarchar(255), |

| | |
|--------------------------|-------------------|
| SetupPathUser | nvarchar(255), |
| NextToLastTimeModified | datetime, |
| UIVersion | int, |
| CheckinComment | nvarchar(1023), |
| WelcomePageUrl | nvarchar(260), |
| WelcomePageParameters | nvarchar(max), |
| tp_Flags | bigint, |
| Acl | varbinary(max), |
| AnonymousPermMask | bigint, |
| DraftOwnerId | int, |
| Level | tinyint, |
| ParentVersion | int, |
| TransformerId | uniqueidentifier, |
| ParentLeafName | nvarchar(128), |
| ProgId | nvarchar(255), |
| DoclibRowId | int, |
| tp_DefaultWorkflowId | uniqueidentifier, |
| ListId | uniqueidentifier, |
| ItemChildCount | int, |
| FolderChildCount | int, |
| MetaInfoVersion | int, |
| {CurVerMetaInfo} | varbinary(max), |
| ContentVersion | int, |
| {bContentVersionIsDirty} | bit, |
| {NextBSN} | bigint, |
| {StreamSchema} | byte, |
| {InternalVersion} | int |

DocId: If the specified document exists, this field MUST be the document identifier (2); otherwise, this MUST be a generated document identifier (2) value for the specified document.

{FullUrl}: The store-relative form URL for the specified document. This value MUST be NULL if the document does not exist. Otherwise, the size of the **nvarchar** type returned SHOULD vary depending on whether or not the store-relative form URL has only a directory name, only a leaf name, or both. If it has an empty directory name, it SHOULD be returned as **nvarchar(128)**. If it has an empty leaf name, it SHOULD be returned as **nvarchar(256)**. Otherwise, it MUST be returned as **nvarchar(385)**. Since a front-end Web server cannot determine which type will be returned in advance, it MUST allow for a data type returned as **nvarchar(385)**.

Type: The **Document Store Type** (section [2.2.2.4](#)) of this document. This value MUST be NULL if the requested document does not exist.

MetaInfoTimeLastModified: A datetime with a timestamp in UTC format specifying the last time the **MetaInfo** value of this document was changed. This value MUST be NULL if the document does not exist.

MetaInfo: A metadict for the document. The metadict format is specified in [\[MS-FPSE\]](#) section 2.2.2.2.11. This value MUST be NULL if the document does not exist.

Size: The number of bytes in the document stream. This value MUST be NULL if the document does not exist.

TimeCreated: A datetime with a timestamp in UTC format specifying when this document was created. This value MUST be NULL if the document does not exist.

TimeLastModified: A datetime with a timestamp in UTC format specifying when the document was last modified. This corresponds to the **TimeCreated** (for historical versions) or **TimeLastModified** (for current versions) of the document. This value MUST be NULL if the document does not exist.

ETagVersion: A counter used for internal conflict detection that is incremented any time a change is made to this document. This value MUST be NULL if the document does not exist.

DocFlags: A **Doc Flags** value (section [2.2.2.3](#)) describing the document. This value MUST be NULL if the document does not exist.

{ListType}: A combination of the **List Base Type** (section [2.2.1.2.11](#)) and **List Server Template** (section [2.2.1.2.12](#)) values of the associated list (1) for this document, where the **List Server Template** value is multiplied by 256 and added to the value of the **List Base Type**. This value MUST be NULL if the document does not exist or is not in a list (1).

tp_Name: The identifier of the list (1) that contains this document. This value MUST be NULL if the document does not exist or is not in a list (1).

{ListTitle}: If this document is the root folder of a list (1), this contains the display name of the list (1). This value MUST be NULL if the document does not exist or is not in a list (1).

{CacheParseId}: This value MUST be NULL.

GhostDirName: The directory name as passed to **proc_GetDocsMetaInfo** (section [3.1.5.29](#)) in the *@DirName#* parameter.

GhostLeafName: The leaf name as passed to **proc_GetDocsMetaInfo** in the *@LeafName#* parameter.

tp_Login: If the document exists and is currently checked out, **tp_Login** is the login name of the user to whom it is checked out. In all other cases, this is NULL.

CheckoutDate: A datetime with a timestamp in UTC format specifying when this document was checked out. This value MUST be NULL if the document does not exist or is currently checked in.

CheckoutExpires: A datetime with a timestamp in UTC format specifying when the short-term lock for this document will expire. If this date is in the past, the document SHOULD be treated as unlocked. This value can be NULL if no short-term lock has been placed on the document.

VirusStatus: A **Virus Status** value (section [2.2.1.2.17](#)) specifying the current virus state of this document. This value can be NULL if the document has not been processed by a virus scanner. This value MUST be NULL if the document does not exist.

VirusInfo: A string containing a provider-specific message returned by the virus scanner when it last processed the document. This value MUST be NULL if the document does not exist or has not been processed by a virus scanner.

SetupPathVersion: For an uncustomized document, this specifies the setup path location that the **SetupPath** fragment is relative to. This value MUST NOT be NULL. The following are valid values.

| Value | Description |
|-------|--|
| 2 | This is relative to the install location of Windows SharePoint Services 2.0 on the front-end Web server (for example, Program Files\Common Files\Microsoft Shared\Web Server Extensions\60). |
| 3 | This is relative to the install location of Windows SharePoint Services 3.0 on the front-end Web server (for example, Program Files\Common Files\Microsoft Shared\Web Server Extensions\12). |

| Value | Description |
|-------|---|
| 4 | This is relative to the install location of Microsoft SharePoint Foundation 2010 on the front-end Web server (for example, Program Files\Common Files\Microsoft Shared\Web Server Extensions\14). |
| 15 | This is relative to the install location of Microsoft SharePoint Foundation 2013 on the front-end Web server (for example, Program Files\Common Files\Microsoft Shared\Web Server Extensions\15). |

SetupPath: For a document that is or has been uncustomized, this contains the setup path fragment relative to the base setup path specified by the **SetupPathVersion** value, where the document stream of this document can be found. This value MUST be NULL if the document does not exist or was never uncustomized.

SetupPathUser: If this document is now or once was uncustomized, this contains the login name of the user that created the uncustomized document. This value MUST be NULL if the document does not exist or was never uncustomized.

NextToLastTimeModified: The value of **TimeLastModified** from the previous time when the document was last saved. This value MUST be NULL for documents that do not exist.

UIVersion: The UI version number of the document. This value MUST be NULL for documents that do not exist.

CheckinComment: An optional user-supplied description provided when a document is checked in or published. This value MUST be NULL for documents that do not exist or are not checked in.

WelcomePageUrl: If this document is a folder, this specifies an optional page to redirect to when the folder is requested with an HTTP GET operation. The URL is relative to the URL of the folder itself, and MUST be contained within that folder. Attempts to break out of the folder, such as ".././somepage.aspx", are not valid. This value MUST be NULL if the document does not exist or a welcome page is not specified.

WelcomePageParameters: Contains optional URL parameters to specify as part of the **WelcomePageUrl** value. These parameters are the URL substring starting at either the query string signifier '?' or the bookmark signifier '#'. This value MUST be NULL if the document that do not exist or parameters are not specified.

tp_Flags: The **List Flags** value (section [2.2.2.5](#)) for the list (1) that contains this document. This value MUST be NULL for documents that do not exist or are not in a list (1).

Acl: The binary serialization of the **WSS ACL Format** (section [2.2.3.6](#)) ACL for this document. The WSS ACL is either explicitly defined for the document, or inherited from the parent object of the document. This value MUST be NULL for documents that do not exist.

AnonymousPermMask: A **WSS Rights Mask** (section [2.2.2.15](#)) indicating the rights granted to an anonymous user, or to a user who has no specific rights to this document. The value MUST be NULL for documents that do not exist.

DraftOwnerId: The **User Identifier** (section [2.2.1.1.13](#)) of the user that published this document as a draft. This value MUST be NULL if the document does not exist or is not a draft version.

Level: A **Publishing Level Type** value (section [2.2.2.6](#)) specifying the publishing status of this document. This value MUST be NULL if the document does not exist.

ParentVersion: If the document is a transformed version of another document, this is the UI version value from the parent document. This value MUST be NULL if the document does not exist or is not the product of a document transformation.

TransformerId: If this document is a transformed version of another document, this is the GUID of the agent that performed the transformation. This value MUST be NULL if the document does not exist or is not the product of a document transformation.

ParentLeafName: If the document is a transformed version of another document, this is the leaf name of the original document. The original document MUST be in the same folder as the transformed document. If either is moved, the relationship between the original and transformed document is broken. This value MUST be NULL if the document does not exist or is not the product of a document transformation.

ProgId: Specifies a **ProgId** or preferred application to open the document. The **ProgId** value is used to distinguish between different applications that save files with a given file extension (for example, different editors for .HTML or .XML files). This value MUST be NULL if the document does not exist or if a **ProgId** was not specified when the document was saved.

DoclibRowId: The identifier for a row in a document library for this item. This value MUST be NULL if the document does not exist or is not contained in a list (1).

tp_DefaultWorkflowId: The workflow identifier corresponding to the workflow (2) to be invoked if the document is in a moderated list and the document is submitted for approval as part of a check in. This value MUST be NULL if the document does not exist or is not contained in a list (1) with a configured approval workflow (2).

ListId: The list identifier of the list (1) that contains the document. This value MUST be NULL if the document does not exist or is not contained in a list (1).

ItemChildCount: The number of non-folder children of the document.

FolderChildCount: The number of folder children of the document.

MetaInfoVersion: A counter used for internal conflict detection that is incremented any time a change is made to the **MetaInfo** for the document.

{CurVerMetaInfo}: This value MUST be NULL.

ContentVersion: A counter used for internal conflict detection that is incremented any time a change is made to the binary contents of this document. This value MUST be NULL if the document does not exist.

{bContentVersionIsDirty}: This value specifies whether the **ContentVersion** value can be used for conflict detection. If the **ContentVersion** value can be used for conflict detection or the **ContentVersion** value is NULL, this value MUST be zero; otherwise, the value MUST be one.

{NextBSN}: The current BLOB sequence number of the document being returned.

{StreamSchema}: The current stream schema of the document being returned.

{InternalVersion}: The internal version number of the document being returned.

3.1.5.30 proc_GetLinkInfoSingleDoc

The **proc_GetLinkInfoSingleDoc** stored procedure provides link information and status for all forward links within a specified document and for all backward links within the specified site collection to the document.

```
PROCEDURE proc_GetLinkInfoSingleDoc(
    @DocSiteId          uniqueidentifier,
    @DocDirName         nvarchar(256),
    @DocLeafName        nvarchar(128),
    @Level              tinyint,
    @RequestGuid        uniqueidentifier = NULL OUTPUT
);
```

@DocSiteId: The **Site Collection Identifier** (section [2.2.1.1.9](#)) for a site collection containing the document.

@DocDirName: The directory name of the document.

@DocLeafName: The leaf name of the document.

@Level: A **Publishing Level Type** (section [2.2.2.6](#)) indicating the publishing level of the document.

@RequestGuid: The optional request identifier for the current request.

Return Values: This stored procedure **MUST** return an integer return code of 0.

This stored procedure **MUST** return a single result set, as specified in the following section.

3.1.5.30.1 Link Info Single Doc Result Set

The **Link Info Single Doc Result Set** contains information about links to or within the requested document. Entries are present both for forward links and for backward links. The **Link Info Single Doc Result Set** **MUST** be returned, and **MUST** contain one row for each forward link within the specified document, and one row for each backward link to the document within the specified site collection. The **Link Info Single Doc Result Set** is defined in section **Link Information Result Set** (section [2.2.4.13](#)), located in the Common Result Sets (section [2.2.4](#)).

3.1.5.31 proc_GetListCheckedOutFiles

The **proc_GetListCheckedOutFiles** stored procedure is invoked to retrieve a list of all documents with a **Document Store Type** (section [2.2.2.4](#)) of 0 (File) within a specified list, folder, or its subfolders, which are checked out and do not have checked in draft or published versions.

```
PROCEDURE proc_GetListCheckedOutFiles(
    @SiteId             uniqueidentifier,
    @ListUrl            nvarchar(260),
    @RequestGuid        uniqueidentifier = NULL OUTPUT
);
```

@SiteId: The site collection identifier of the site collection containing the list.

@ListUrl: The directory name which contains the document(s), preceded with a leading slash ("/").

@RequestGuid: The optional request identifier for the current request.

Return Values: The **proc_GetListCheckedOutFiles** stored procedure returns an integer return code, which MUST be 0.

The **proc_GetListCheckedOutFiles** stored procedure MUST return one result set.

3.1.5.31.1 Checked Out Files Result Set

The **Checked Out Files Result Set** returns information in the form defined below about the documents which are checked out. The **Checked Out Files Result Set** MUST return one row for each document with a **Document Store Type** (section 2.2.2.4) of 0 (File) in the specified directory which is checked out and does not have a checked in draft or published version.

| | |
|------------------|----------------|
| DirName | nvarchar(256), |
| LeafName | nvarchar(128), |
| DocLibRowId | int, |
| CheckoutUserId | int, |
| {tp_Title} | nvarchar(255), |
| {tp_Email} | nvarchar(255), |
| TimeLastModified | datetime, |
| Size | int; |

DirName: The directory name of the directory containing the document(s).

LeafName: The leaf name of the document.

DocLibRowId: The row identifier for the document within the containing document library. If the document is not contained in a list, this value MUST be NULL.

CheckoutUserId: The user identifier for the user who has this document checked out.

{tp_Title}: The display name of the user specified in **CheckoutUserId**. This parameter MUST NOT be NULL. If display name is unavailable, **{tp_Title}** MUST contain an empty string.

{tp_Email}: The email address of the user specified in **CheckoutUserId**. This parameter MUST NOT be NULL. If the email address is unavailable, **{tp_Email}** MUST contain an empty string.

TimeLastModified: A date/time value in UTC format specifying when the document was last saved.

Size: The size of the document in bytes.

3.1.5.32 proc_GetListFields

The **proc_GetListFields** stored procedure is invoked to get the mapping of fields (2) in a list. The mapping is represented via an XML string specifying each of the fields (2) in the list.

```
PROCEDURE proc_GetListFields(  
    @SiteId                uniqueidentifier,  
    @WebId                 uniqueidentifier,  
    @ListId                uniqueidentifier,  
    @RequestGuid           uniqueidentifier = NULL    OUTPUT  
);
```

@SiteId: The site collection identifier of the site collection.

@WebId: The site identifier of the site containing the list.

@ListId: The list identifier of the list.

@RequestGuid: The optional request identifier for the current request.

Return Values: This procedure returns an integer return code which MUST be 0. This procedure MUST return a single result set as follows.

3.1.5.32.1 Fields Information Result Set

The **Fields Information Result Set** MUST return a single row holding a single column. The **Fields Information Result Set** will be returned once, and MUST contain 0 or 1 rows as follows: if no List was found matching the provided *@WebId* and *@ListId* parameters, then the result set MUST contain 0 rows. Otherwise, the result set MUST contain one row.

```
tp_Fields          nvarchar(max);
```

tp_Fields: Contains a **Compressed** structure. Uncompressed it contains an implementation-specific version string followed by an XML representation of the field definitions. The field definitions include display and interaction options. The XML MUST conform to the **FieldDefinitionDatabaseWithVersion** complex type, as specified in section [2.2.7.3.5](#).

3.1.5.33 proc_GetListMetaDataAndEventReceivers

The **proc_GetListMetaDataAndEventReceivers** stored procedure retrieves information about the metadata, security scopes, Web Parts, and event receivers for a specified list.

```
PROCEDURE proc_GetListMetaDataAndEventReceivers (
    @SiteId          uniqueidentifier,
    @WebId           uniqueidentifier,
    @ListId          uniqueidentifier,
    @PrefetchListScope bit           =0,
    @ThresholdScopeCount int        =0,
    @PrefetchRelatedFields bit      =0,
    @PrefetchWebParts bit           =0,
    @UserId          int            =-1,
    @CurrentFolderUrl nvarchar(260) =NULL,
    @RequestGuid     uniqueidentifier =NULL OUTPUT
);
```

@SiteId: The **Site Collection Identifier** (section [2.2.1.1.9](#)) for a site collection that contains the site specified by the *@WebId* parameter.

@WebId: The **Site Identifier** (section [2.2.1.1.11](#)) for the site containing the list specified by the *@ListId* parameter.

@ListId: The **List Identifier** (section [2.2.1.1.5](#)) for the list.

@PrefetchListScope: Specifies whether to include the **Unique Permissions Result Set** (section [3.1.5.33.2](#)) or **NULL Unique Permissions Result Set** (section [3.1.5.33.3](#)) in the returned result sets. If 1, then the **Unique Permissions Result Set** or **NULL Unique Permissions Result Set** MUST be returned. Otherwise, the **Unique Permissions Result Set** and **NULL Unique Permissions Result Set** MUST NOT be returned.

@ThresholdScopeCount: This parameter MUST be set to a value greater than 0. If the **@PrefetchListScope** parameter is not set to 0, this parameter MUST specify the maximum number of security scopes returned by the **Unique Permissions Result Set**.

@PrefetchRelatedFields: If this parameter is not set to 0, the **List Related Fields Result Set** (section [2.2.4.28](#)) (located in the Common Result Sets (section [2.2.4](#))) MUST be returned.

@PrefetchWebParts: Specifies whether to include the **List Web Parts Result Set** (section [3.1.5.33.5](#)) in the returned result sets. If 1, then the **List Web Parts Result Set** MUST be returned. Otherwise, the **List Web Parts Result Set** MUST NOT be returned.

@UserId: This value can refer to an existing **User Identifier** (section [2.2.1.1.13](#)) for the specified site collection, and defaults to -1, specifying that the contents of the **List Web Parts Result Set** MUST NOT be limited to results for a particular user. When an existing **User Identifier** is specified, the contents of the **List Web Parts Result Set** MUST be limited to Web Parts visible to the specified user.

@CurrentFolderUrl: If this value is set to NULL or an empty string this parameter MUST be ignored. Otherwise, it MUST be the root folder URL that the specified list is contained within.

@RequestGuid: The optional request identifier for the current request.

Return Values: This stored procedure returns an integer return code, which MUST be 0.

This stored procedure MUST return between two and five result sets, depending upon input parameters. Result sets that are returned will be sent in the order defined in the following sections.

3.1.5.33.1 List Metadata Result Set

The **List Metadata Result Set** contains the metadata associated with the list. The **List Metadata Result Set** MUST be returned and MUST contain one row for a valid **List Identifier** (section [2.2.1.1.5](#)) by the **@ListId** parameter. If the **List Identifier** is invalid, the **List Metadata Result Set** MUST contain zero rows.

The **List Metadata Result Set** is defined in section **List Metadata Result Set** (section [2.2.4.14](#)), located in the Common Result Sets (section [2.2.4](#)).

3.1.5.33.2 Unique Permissions Result Set

The **Unique Permissions Result Set** returns any security scopes associated with list items or folders within the specified list. The **Unique Permissions Result Set** MUST be returned when the **@PrefetchListScope** parameter is set to 1, if at least one such security scopes exists. Otherwise, the **NULL Unique Permissions Result Set** MUST be returned to indicate no such security scopes exist. The **Unique Permissions Result Set** MUST contain one row for each security scope defined on any list item or folder within the list, but no more rows than those specified by the **@ThresholdScopeCount** parameter.

The **Unique Permissions Result Set** is defined in section **Unique Permissions Result Set** (section [2.2.4.26](#)), located in the Common Result Sets (section [2.2.4](#)).

3.1.5.33.3 NULL Unique Permissions Result Set

The **NULL Unique Permissions Result Set** indicates that no unique security scopes exist within the specified list. The **NULL Unique Permissions Result Set** MUST be returned if the **@PrefetchListScope** parameter is set to 1 and no security scopes are defined for any list items or folders within the specified list.

The **NULL Unique Permissions Result Set** is defined in section **NULL Unique Permissions Result Set** (section [2.2.4.17](#)), located in the Common Result Sets (section [2.2.4](#)).

3.1.5.33.4 List Event Receivers Result Set

The **List Event Receivers Result Set** contains information about the event receivers defined for this list. The **List Event Receivers Result Set** MUST be returned, and MUST contain one row for each event receiver that is registered for this list, or zero rows if no event receivers are registered for this list.

The **List Event Receivers Result Set** is defined in section **Event Receivers Result Set** (section [2.2.4.11](#)), located in the Common Result Sets (section [2.2.4](#)).

3.1.5.33.5 List Web Parts Result Set

The **List Web Parts Result Set** contains information about the list Web Parts defined for this site. The **List Web Parts Result Set** MUST be returned if the *@PrefetchWebParts* parameter is set to 1. The result set MUST contain one row for each Web Part that is registered for this list. If there are no Web Parts registered for this list, then this result set MUST NOT return any rows.

The **List Web Parts Result Set** is defined in section **List Web Parts Result Set** (section [2.2.4.15](#)), located in the Common Result Sets (section [2.2.4](#)).

3.1.5.33.6 List Related Fields Result Set

The **List Related fields Result Set** returns information about all of the relationship lookup fields whose target list is the specified list. The **List Related fields Result Set** MUST return one row for each of the relationship lookup fields whose target list is the specified list. If there are no such fields, then it MUST return zero rows.

The **List Related Fields Result Set** is defined in section **List Related Fields Result Set** (section [2.2.4.28](#)), located in the Common Result Sets (section [2.2.4](#)).

3.1.5.34 proc_getObject

The **proc_getObject** stored procedure is invoked to retrieve a single Configuration Object (section [2.2.5.1](#)) from the Configuration Database (section [3.1.1](#)). The **proc_getObject** is located in the Configuration Database.

```
PROCEDURE proc_getObject (
    @Id                                uniqueidentifier,
    @RequestGuid                       uniqueidentifier = NULL    OUTPUT
);
```

@Id: Contains the GUID for the Id of the Configuration Object to be retrieved.

@RequestGuid: The optional request identifier for the current request.

Return Values: The **proc_getObject** stored procedure returns an integer return code, which MUST be 0. The **proc_getObject** stored procedure MUST return a single result set as follows.

3.1.5.34.1 Object Result Set

The **Object Result Set** returns the Configuration Object (section [2.2.5.1](#)) identified by *@Id*. If *@Id* is NULL or does not match the value of any configuration objects in the Configuration Database (section [3.1.1](#)), then the **Object Result Set** MUST be returned and MUST return zero rows.

The **Object Result Set** MUST be returned and MUST return one row if the Configuration Object matches the value of *@Id*.

| | |
|------------|-------------------|
| Id | uniqueidentifier, |
| ParentId | uniqueidentifier, |
| ClassId | uniqueidentifier, |
| Name | nvarchar(128), |
| Status | int, |
| Version | rowversion, |
| Properties | nvarchar(max); |

Id: Contains the GUID for the requested Configuration Object.

ParentId: Contains the GUID for the **Parent** (section [2.2.5.1.4](#)) of the Configuration Object.

ClassId: Contains the GUID for the **Class** (section [2.2.5.1.1](#)) of the Configuration Object.

Name: Contains the **Name** (section [2.2.5.1.3](#)) of the requested Configuration Object.

Status: Contains the **Status** (section [2.2.5.1.5](#)) of the Configuration Object.

Version: Contains the **Version** (section [2.2.5.1.6](#)) of the Configuration Object.

Properties: Contains the properties definition of the Configuration Object, which is opaque to the back-end database server.

3.1.5.35 proc_getObjectsByBaseClass

The **proc_getObjectsByBaseClass** stored procedure is invoked to return a list of **GUIDs** for child Configuration Objects (section [2.2.5.1](#)) of the specified parent Configuration Object that inherit from the specified base **Class** (section [2.2.5.1.1](#)). The **proc_getObjectsByBaseClass** is located in the Configuration Database (section [3.1.1](#)).

```
PROCEDURE proc_getObjectsByBaseClass (  
    @BaseClassId          uniqueidentifier,  
    @ParentId            uniqueidentifier,  
    @RequestGuid         uniqueidentifier = NULL    OUTPUT  
);
```

@BaseClassId: Contains the GUID for the base **Class** of the requested Configuration Objects.

@ParentId: Contains the GUID for the **Parent** (section [2.2.5.1.4](#)) Configuration Object of the requested Configuration Objects.

@RequestGuid: The optional request identifier for the current request.

Return Values: The **proc_getObjectsByBaseClass** stored procedure returns an integer return code which MUST be 0. The **proc_getObjectsByBaseClass** stored procedure MUST return a single result set as follows.

3.1.5.35.1 Object ID Result Set

The **Object ID Result Set** contains the GUIDs of the matching Configuration Objects (section [2.2.5.1](#)), if any. The **Object ID Result Set** MUST contain zero rows if no matching Configuration Objects are found, and MUST contain one row for each matching Configuration Object found. The **Object ID Result Set** is defined in the Common Result Sets **Object ID Result Set** (section [2.2.4.18](#)).

3.1.5.36 proc_getObjectsByClass

The **proc_getObjectsByClass** stored procedure is invoked to retrieve the GUIDs of Configuration Objects (section [2.2.5.1](#)) based upon the **Class** (section [2.2.5.1.1](#)) type, the parent Configuration Object, and the **Name** (section [2.2.5.1.3](#)) of the Configuration Object. The **proc_getObjectsByClass** is located in the Configuration Database (section [3.1.1](#)).

```
PROCEDURE proc_getObjectsByClass(  
    @ClassId                uniqueidentifier,  
    @ParentId               uniqueidentifier,  
    @Name                   nvarchar(128),  
    @RequestGuid            uniqueidentifier = NULL    OUTPUT  
);
```

@ClassId: Contains the GUID of the **Class** type of the requested Configuration Objects. MUST NOT be NULL.

@ParentId: Contains the GUID for the **Parent** (section [2.2.5.1.4](#)) Configuration Object of the requested Configuration Objects.

@Name: Contains the **Name** of the requested Configuration Object.

@RequestGuid: The optional request identifier for the current request.

Return Values: The **proc_getObjectsByClass** stored procedure returns an integer return code which MUST be listed in the following table.

| Value | Description |
|-------|------------------------------|
| 0 | Successful execution. |
| 50105 | Error: Class does not exist. |

The **proc_getObjectsByClass** stored procedure MUST return a single result set as follows.

3.1.5.36.1 Object ID Result Set

The **Object ID Result Set** contains the GUIDs of the matching Configuration Object (section [2.2.5.1](#)), if any. The **Object ID Result Set** MUST contain zero rows if no matching Configuration Object are found. A Configuration Object MUST match if **@ParentId** is NULL or **@ParentId** is equal to the GUID of the parent of the Configuration Object. In addition, a Configuration Object MUST match if **@Name** is null OR **@Name** is equal to the **Name** of the Configuration Object. The **Object ID Result Set** is defined in the Common Result Sets **Object ID Result Set** (section [2.2.4.18](#)).

3.1.5.37 proc_GetSiteFlags

The **proc_GetSiteFlags** stored procedure is invoked to return the **Site Collection Flags** (section [2.2.2.9](#)) set for a specified site collection.

```
PROCEDURE proc_GetSiteFlags(  
    @WebSiteId                uniqueidentifier,  
    @RequestGuid              uniqueidentifier = NULL OUTPUT  
);
```

@WebSiteId: The **Site Collection Identifier** (section [2.2.1.1.9](#)) of the site collection for which to retrieve **Site Collection Flags**.

@RequestGuid: The optional request identifier for the current request.

Return Values: This stored procedure **MUST** return an integer return code of 0.

This stored procedure **MUST** return the following result set.

3.1.5.37.1 Site Collection Flags Result Set

The **Site Collection Flags Result Set** returns the **Site Collection Flags** (section [2.2.2.9](#)) for a specified site collection. The **Site Flags Result Set** will be returned, and **MUST** contain one row.

```
{SiteCollectionFlags}      int;
```

{SiteCollectionFlags}: Contains the **Site Collection Flags** for the specified site collection. This **MUST** be NULL if the site collection specified by the **@WebSiteId** parameter does not exist, is NULL, or is a **NULL GUID**.

3.1.5.38 proc_getSiteMap

The **proc_getSiteMap** stored procedure is invoked to determine the **Site Map** (section [3.1.5.38.1](#)) information for a site collection. **proc_getSiteMap** is located in the Configuration Database (section [3.1.1](#)).

```
PROCEDURE proc_getSiteMap(  
    @ApplicationId            uniqueidentifier,  
    @Path                    nvarchar(128),  
    @RequestGuid              uniqueidentifier = NULL    OUTPUT  
);
```

@ApplicationId: The Web application identifier containing the site collection specified by the **@Path** parameter.

@Path: The server-relative path to the root of the site collection. Set **@Path** to '/' to specify a site collection which is the root of the Web application (1).

@RequestGuid: The optional request identifier for the current request.

Return Values: The **proc_getSiteMap** stored procedure returns an integer return code, which **MUST** be 0. The **proc_getSiteMap** stored procedure **MUST** return a single result set.

3.1.5.38.1 Site Map Result Set

The **Site Map Result Set** returns the Site Map information for the site collection specified by the *@ApplicationId* and *@Path* parameter values. The **Site Map Result Set** MUST return zero rows if the parameters do not match any Site Map information; it MUST return one row if a match is found.

| | |
|------------------|-------------------|
| Id | uniqueidentifier, |
| SubscriptionId | uniqueidentifier, |
| DatabaseId | uniqueidentifier, |
| RedirectUrl | nvarchar(512), |
| Pairing | tinyint, |
| SubscriptionName | nvarchar(48), |
| AppSiteDomainId | varchar(6); |

Id: Contains the **Site Collection Identifier** (section [2.2.1.1.9](#)) for the requested site collection.

SubscriptionId: The GUID of the implementation-specific subscription feature for the requested site collection.

DatabaseId: Contains the GUID of the database containing the content of the requested site collection.

RedirectUrl: The URL used to access the specified site collection during an implementation-specific upgrade operation. This value MUST be NULL if the site collection upgrade to the current implementation-specific version is complete.

Pairing: Contains an implementation-specific integer value denoting that a given object is paired with a matching object of a previous version. This parameter is used during a implementation-specific upgrade operation.

| Value | Description |
|-------|--|
| 0 | This object is not paired. |
| 1 | This object is paired with an object from a previous major version of the product. |

SubscriptionName: The name corresponding to the site subscription identifier of the implementation-specific subscription for the requested site collection.

AppSiteDomainId: The app site domain identifier of the site collection.

3.1.5.39 proc_getSiteMapById

The **proc_getSiteMapById** stored procedure is invoked to determine complete Site Map (section [3.1.5.38.1](#)) information for a site collection. **proc_getSiteMapById** is located in the Configuration Database (section [3.1.1](#)).

```
PROCEDURE proc_getSiteMapById(  
    @SiteId uniqueidentifier,  
    @RequestGuid uniqueidentifier = NULL OUTPUT  
);
```

@SiteId: The **Site Collection Identifier** (section [2.2.1.1.9](#)) of the site collection to get Site Map (section [3.1.5.38.1](#)) information for.

@RequestGuid: The optional request identifier for the current request.

Return Values: The `proc_getSiteMapById` stored procedure returns an integer return code which MUST be 0. The `proc_getSiteMapById` stored procedure MUST return a single result set.

3.1.5.39.1 Site Map By Id Result Set

The **Site Map By Id Result Set** returns information about the Web application (1), database, and URL mapped to the specified site collection. The **Site Map By Id Result Set** MUST contain one row if the specified site collection identifier exists in the Configuration Database (section [3.1.1](#)) on the back-end database server. Otherwise, it MUST contain zero rows.

| | |
|----------------------|-------------------|
| ApplicationId | uniqueidentifier, |
| DatabaseId | uniqueidentifier, |
| Id | uniqueidentifier, |
| SubscriptionId | uniqueidentifier, |
| Path | nvarchar(128), |
| RedirectUrl | nvarchar(512), |
| Pairing | tinyint, |
| HostHeaderIsSiteName | bit, |
| SubscriptionName | nvarchar(48), |
| AppSiteDomainId | varchar(6); |

ApplicationId: The Web application identifier hosting the content of the requested site collection.

DatabaseId: The GUID of the database containing the content of the requested site collection.

Id: The **Site Collection Identifier** (section [2.2.1.1.9](#)) for the requested site collection.

SubscriptionId: The GUID of the implementation-specific subscription for the requested site collection.

Path: The URL used to identify the requested site collection. For site collections that do not use a specifically-configured host domain, the **HostHeaderIsSiteName** field MUST be 0 and the **Path** value MUST be the server-relative URL of the root site of the site collection. For site collections using host header mode (that is, site collections identified by host header identifier rather than by server-relative URL path), the **HostHeaderIsSiteName** field MUST be 1 and the **Path** value for the site collection MUST be the **host name**, and MUST include the port number for hosts at non-default ports, and can include the port number for hosts at default ports.

RedirectUrl: The URL used to access the specified site collection during an implementation-specific upgrade operation. This value MUST be NULL if the site collection upgrade to the current implementation-specific version number is complete.

Pairing: An integer value used during an implementation-specific upgrade operation to denote that a given object is paired with a matching object of a previous implementation-specific version number. The following are valid values.

| Value | Description |
|-------|--|
| 0 | This object is not paired. |
| 1 | This object is paired with an object from a previous major version of the product. |

HostHeaderIsSiteName: This value MUST be set to 1 if the requested site collection uses host header mode; otherwise it MUST be 0. The Path field MUST contain the URL for the specified **HostHeaderIsSiteName** value.

SubscriptionName: The name corresponding to the site subscription identifier of the implementation-specific subscription for the requested site collection.

AppSiteDomainId: The app site domain identifier of site collection.

3.1.5.40 **proc_GetTpWebMetaDataAndListMetaData**

The **proc_GetTpWebMetaDataAndListMetaData** stored procedure retrieves metadata for a particular site (2) or list (1).

```
PROCEDURE proc_GetTpWebMetaDataAndListMetaData (
    @WebSiteId                uniqueidentifier,
    @WebId                    uniqueidentifier,
    @Url                      nvarchar(260),
    @ListId                   uniqueidentifier,
    @ViewId                   uniqueidentifier,
    @RunUrlToWebUrl          bit,
    @DGCacheVersion          bigint,
    @SystemId                 varbinary(512)      = NULL,
    @AppPrincipalName        nvarchar(256),
    @IsHostHeaderAppPrincipalName bit,
    @MetadataFlags           int                 = 0,
    @ThresholdScopeCount     int                 = 0,
    @CurrentFolderUrl        nvarchar(260)      = NULL,
    @RequestGuid             uniqueidentifier    = NULL OUTPUT
);
```

@WebSiteId: The site collection identifier for a site collection containing the site.

@WebId: The site identifier of the site for which metadata is requested, or of the site containing the list for which metadata is requested. This parameter is ignored if the **@MetadataFlags** has the **METADATA_WEB** flag set and if values in **@WebSiteId** and **@URL** are valid.

@Url: The store-relative form URL of the site or list to retrieve metadata for.

@ListId: The list identifier of the list for which metadata is requested. This parameter is optional and MUST be NULL if no list metadata is required.

@ViewId: The Web Part identifier that is registered for the list specified by the **@ListId** parameter. If this parameter is set to NULL, then the **tp_AllUsersProperties**, **tp_PerUserProperties**, and **tp_Cache** columns returned by the **List Web Parts Result Set** (section [2.2.4.15](#)) (found in the Common Result Sets (section [2.2.4](#))) will be set to NULL.

@RunUrlToWebUrl: A bit flag specifying whether the **@URL** parameter is for a site or for a list within a site. If this value is set to "1", the value in **@URL** is for a list, and MUST be converted to a store-relative form URL for the containing site.

@DGCacheVersion: The version number of the Domain Group Map Cache in the front-end Web server. This can be compared with the Domain Group Map Cache version number on the back-end database server returned in the **Domain Group Cache Versions Result Set** (section [2.2.4.4](#)) to determine whether updates are needed. A **@DGCacheVersion** value of -2 specifies that information about the Domain Group Map Cache is not requested, and the **Domain Group Cache BEDS**

Update Result Set (section [2.2.4.3](#)) and the **Domain Group Cache WFE Update Result Set** (section [2.2.4.5](#)) MUST NOT be returned.

@SystemId: The **SystemId** of the current user requesting the metadata.

@AppPrincipalName: The app principal identifier or the app web domain identifier associated with the current user. If the current user is not associated with an app principal, this parameter MUST be NULL.

@IsHostHeaderAppPrincipalName: If this parameter is set to 1, the **@AppPrincipalName** parameter MUST be the app principal identifier, else it MUST be the app web domain identifier.

@MetadataFlags: A bit field used to determine the types of metadata returned by this procedure. The only valid values of the **@MetadataFlags** bits are specified as follows.

| Symbolic name, Value | Description |
|---|---|
| METADATA_NONE , 0x00000000 | Do not provide any metadata. |
| METADATA_FETCH_VIEWS , 0x00000001 | Retrieve list views. This flag is set in combination with METADATA_LISTMETADATA_NOFETCH and the @ListID variable and will result in the List Web Parts Result Set (section 3.1.5.40.21). |
| METADATA_PREFETCH_SCOPES , 0x00000002 | Retrieve security scopes. If this flag is set and @ListId is not NULL and METADATA_LISTMETADATA_NOFETCH is not set, then the List Unique Permissions Result Set (section 3.1.5.40.18) will be returned. |
| METADATA_SAVE_SCOPE_DATA , 0x00000004 | Save scope data. This flag is currently unused. |
| METADATA_FIGURE_TYPE , 0x00000008 | Setting this flag in combination with NULL ListID will result in retrieving the ListID values directly from the AllDocs table (section 2.2.6.1). |
| METADATA_WEB , 0x00000010 | Retrieve information pertaining to the provided site information. This flag is used in combination with other flags to further define the set or sets of information to be retrieved. |
| METADATA_URL , 0x00000020 | Setting this flag will populate the ListId column for all results, including those which are not list items. When used in combination with a valid @WebSiteId , if @ListId is NULL or doesn't match the list contained within the site identified by @WebSiteId , the Document Metadata Result Set (section 2.2.4.8) is returned. |
| METADATA_USERINFOLIST , 0x00000040 | Return User information. Setting this flag when METADATA_USERINFOLIST_NOFETCH is not set opens the option for List Metadata Result Set (section 2.2.4.14), List Unique Permissions Result Set (section 3.1.5.40.18), Event Receivers Result Set (section 2.2.4.11), and the List Web Parts Result Set (section 3.1.5.40.21). |
| METADATA_USERINFOLIST_FULL , 0x00000080 | Return full User information. Setting this flag in combination with METADATA_USERINFOLIST when METADATA_USERINFOLIST_NOFETCH , is not set, |

| Symbolic name, Value | Description |
|--|--|
| | along with a valid Site Identifier in <i>@WebSiteId</i> , where <i>@ListId</i> is NULL or does not match a list identifier contained within the site specified by <i>@WebSiteId</i> , returns the Event Receivers Result Set (section 3.1.5.40.20) and the List Web Parts Result Set (section 3.1.5.40.21). |
| METADATA_WEB_PROP , 0x00000100 | Return site data. Setting this flag in combination with METADATA_WEB will retrieve the Site MetaInfo Result Set (section 2.2.4.25). |
| METADATA_WEB_FEATURES , 0x00000200 | Return site features. Setting this flag in combination with METADATA_WEB will retrieve the Site Feature List Result Set (section 2.2.4.23). |
| METADATA_WEB_NAVSTRUCT , 0x00000400 | Return navigation structure. Setting this flag in combination with METADATA_WEB will retrieve the Site Unique Permissions Result Set (section 3.1.5.40.10). |
| METADATA_LISTMETADATA_NOFETCH , 0x00000800 | Do not return list metadata. Setting this flag will suppress the retrieval of the List Metadata Result Set (section 3.1.5.40.16), Unique Permissions Result Set (section 3.1.5.40.23), and the Event Receivers Result Set (section 3.1.5.40.20) using the List identification parameters. |
| METADATA_USERINFOLIST_NOFETCH , 0x00001000 | Do not return User information. Setting this flag will suppress the retrieval of the List Metadata Result Set (section 3.1.5.40.16), Unique Permissions Result Set (section 2.2.4.26), Event Receivers Result Set (section 3.1.5.40.20), and the List Web Parts Result Set (section 3.1.5.40.21) using the User identification parameters. |
| METADATA_URL_REALLY , 0x00002000 | Return single document metadata. Setting this flag will return the Document Metadata Result Set (section 3.1.5.40.27). |
| METADATA_WEB_WELCOMEPAGE , 0x00004000 | Redirect welcome page. Setting this flag in combination with METADATA_WEB will retrieve the Redirect URL Result Set (section 3.1.5.40.13). |
| METADATA_PREFETCH_RELATEDFIELDS , 0x00008000 | Return the List Related Fields Result Set (section 2.2.4.28) if the <i>@MetadataFlags</i> parameter does not contain METADATA_LISTMETADATA_NOFETCH . |

@ThresholdScopeCount: This parameter MUST be set to a value greater than 0. If the *@MetadataFlags* parameter does not contain **METADATA_LISTMETADATA_NOFETCH** and contains **METADATA_PREFETCH_SCOPES**, this parameter MUST specify the maximum number of security scopes returned by the **List Unique Permissions Result Set** (section [3.1.5.40.18](#)).

@CurrentFolderUrl: If this value is set to NULL or an empty string, this parameter MUST be ignored. Otherwise, it MUST be the root folder URL that the specified list is contained within.

@RequestGuid: The optional request identifier for the current request.

Return Values: The **proc_GetTpWebMetaAndListMeta** stored procedure returns an integer return code, which MUST be in the following table.

| Value | Description |
|-------|--|
| 0 | Successful operation. |
| 1 | Cross Site attack detected. |
| 2 | The attempt to retrieve a redirected URL failed. |
| 3 | The specified URL was not found. |
| 1168 | The site collection specified by <i>@WebSiteId</i> was not found. |
| 1271 | Access to the site is blocked because the site collection is locked. |

Result Sets: The **proc_GetTpWebMetaDataAndListMetaData** stored procedure returns up to 30 result sets, depending on the state of the input parameters.

3.1.5.40.1 Web Url Result Set

The **Web Url Result Set** contains the store-relative form URL of the root of the Site which contains the *@Url* parameter.

The **Web Url Result Set** MUST be returned when *@MetadataFlags* has the **METADATA_WEB** flag set, *@RunUrlToWebUrl* is set to 1, and *@WebSiteId* is a valid **Site Collection Identifier**, and MUST contain one row of data. If *@MetadataFlags* has the **METADATA_WEB** flag set, *@RunUrlToWebUrl* is set to 1, and *@WebSiteId* is not found, **proc_GetTpWebMetaDataAndListMetaData** MUST NOT return any result sets.

```
{WebUrl} nvarchar(260);
```

{WebUrl}: The store-relative form URL of the Site containing the *@Url* parameter.

3.1.5.40.2 Domain Group Cache Versions Result Set

The **Domain Group Cache Versions Result Set** contains information about the version numbers associated with the Domain Group Map Caches on the front-end Web server and on the back-end database server for the specified site collection.

The **Domain Group Cache Versions Result Set** MUST be returned when *@Url* specifies a valid location within or of a site and *@MetadataFlags* has the **METADATA_WEB** flag set, and MUST contain one row of version number data. If *@MetadataFlags* has the **METADATA_WEB** flag set, and *@Url* does not specify either a valid site, or if *@RunUrlToWebUrl* is set to 1, a valid location within a site, then **proc_GetTpWebMetaDataAndListMetaData** MUST NOT return this or any further result sets.

If the specified *@DGCACHEVersion* value is -2, then all columns returned MUST have the value -2, indicating that the value MUST NOT be used for comparison. The **Domain Group Cache Versions Result Set** is defined in the Common Result Sets **Domain Group Cache Versions Result Set** (section [2.2.4.4](#)).

3.1.5.40.3 Domain Group Cache BEDS Update Result Set

The **Domain Group Cache BEDS Update Result Set** contains information to be used in recomputing the domain group map cache, which contains the mapping of domain groups to the **security groups** they are members of. The presence of the **Domain Group Cache BEDS Update**

Result Set means the database's copy of the domain group map cache is out of date and **MUST** be recomputed to ensure that proper security checks can be made.

The **Domain Group Cache BEDS Update Result Set** **MUST** be returned only if the **Domain Group Cache Versions Result Set** is returned, *@DGCacheVersion* does not contain "-2", and the value of **RealVersion** is greater than the **CachedVersion** in the results in the **Domain Group Cache Versions Result Set**.

The **Domain Group Cache BEDS Update Result Set** schema is defined in the Common Result Sets **Domain Group Cache BEDS Update Result Set** (section [2.2.4.3](#)).

3.1.5.40.4 Domain Group Cache WFE Update Result Set

The **Domain Group Cache WFE Update Result Set** contains the binary data needed to refresh the domain group map cache. The presence of the **Domain Group Cache WFE Update Result Set** means the domain group map cache on the database is up to date, and the front-end Web server cache can be refreshed if necessary.

The **Domain Group Cache WFE Update Result Set** **MUST** be returned only if the **Domain Group Cache Versions Result Set** is returned, and *@DGCacheVersion* does not contain "-2", and the value of **RealVersion** is less than or equal to **CachedVersion** in the results in **Domain Group Cache Versions Result Set**. The **Domain Group Cache WFE Update Result Set** **MUST** contain one row of data.

The **Domain Group Cache WFE Update Result Set** schema is defined in the Common Result Sets **Domain Group Cache WFE Update Result Set** (section [2.2.4.5](#)).

3.1.5.40.5 Site Metadata Result Set

The **Site Metadata Result Set** contains specialized site metadata. The **Site Metadata Result Set** **MUST** be returned when the **Domain Group Cache Versions Result Set** is returned, and it **MUST** contain one row.

The **Site Metadata Result Set** is defined in the Common Result Sets **Site Metadata Result Set** (section [2.2.4.24](#)).

3.1.5.40.6 Site Collection Event Receivers Result Set

The **Site Collection Event Receivers Result Set** contains information about the event receivers defined for the site collection specified by the *@WebSiteId* parameter. The **Site Collection Event Receivers Result Set** **MUST** be returned when execution is successful, and the **List Metadata Result Set** has been returned.

The **Site Collection Event Receivers Result Set** **MUST** contain one row for each event receiver with an **Event Host Type** (section [2.2.1.2.5](#)) of 0 registered for the site collection specified by the *@WebSiteId* parameter.

The **Site Collection Event Receivers Result Set** is defined in **Event Receivers Result Set** (section [2.2.4.11](#)), located in the Common Result Sets (section [2.2.4](#)).

3.1.5.40.7 Site Event Receivers Result Set

The **Event Receivers Result Set** contains information about the event receivers defined for this site. The **Event Receivers Result Set** **MUST** be returned when the **Domain Group Cache Versions Result Set** is returned, and it **MUST** contain one row for each event receiver registered for this site. If this **Event Receivers Result Set** is returned, and the site collection specified by

@WebSiteId is locked, then **proc_GetTpWebMetaDataAndListMetaData** MUST NOT return any further result sets.

The **Event Receivers Result Set** is defined in the Common Result Sets **Event Receivers Result Set** (section [2.2.4.11](#)).

3.1.5.40.8 Site MetaInfo Result Set

The **Site MetaInfo Result Set** contains the metadata of the site. The **Site MetaInfo Result Set** MUST be returned when execution is successful, and *@MetadataFlag* has the **METADATA_WEB** flag set and the **METADATA_WEB_PROP** flag set, and MUST contain one row if the *@WebId* parameter is valid. If the *@MetadataFlag* has the **METADATA_WEB** flag set and the **METADATA_WEB_PROP** flag set, and the site specified by *@WebId* does not exist, then the result set MUST contain no rows, and **proc_GetTpWebMetaDataAndListMetaData** MUST NOT return any further result sets.

The **Site MetaInfo Result Set** is defined in the Common Result Sets **Site MetaInfo Result Set** (section [2.2.4.25](#)).

3.1.5.40.9 Site Feature List Result Set

The **Site Feature List Result Set** contains the list of **Feature Identifiers** (section [2.2.1.1.4](#)) of the site. The **Site Feature List Result Set** MUST be returned and MUST contain one row for each feature when execution is successful, and all of the following conditions are met:

- *@MetadataFlag* has the **METADATA_WEB** flag set
- *@MetadataFlag* has the **METADATA_WEB_FEATURES** flag set
- *@WebSiteId* is valid
- *@WebId* is valid

The **Site Feature List Result Set** MUST be returned twice with the same schema, once for the default features for the site collection, and again with the features for the specified site.

The **Site Feature List Result Set** is defined in the Common Result Sets **Site Feature List Result Set** (section [2.2.4.23](#)).

3.1.5.40.10 Site Unique Permissions Result Set

The **Unique Permissions Result Set** contains security scope and **WSS ACL** (section [2.2.3.6](#)) information of the site specified by *@WebId*. The **Unique Permissions Result Set** MUST be returned when execution is successful, and all of the following conditions are met:

- *@MetadataFlags* has the **METADATA_WEB** flag set
- *@MetadataFlags* has the **METADATA_WEB_NAVSTRUCT** flag set
- The specified site contains cached navigation scope information.

The **Unique Permissions Result Set** is defined in the Common Result Sets **Unique Permissions Result Set** (section [2.2.4.26](#)).

3.1.5.40.11 Site NULL Unique Permissions Result Set

The **NULL Unique Permissions Result Set** MUST be returned when execution is successful, and all of the following conditions are met:

- *@MetadataFlags* has the **METADATA_WEB** flag set
- *@MetadataFlags* has the **METADATA_WEB_NAVSTRUCT** flag set
- The site specified by *@WebId* or its parent site's cached navigation scope is over 900 characters long.

The **NULL Unique Permissions Result Set** is defined in the Common Result Sets **NULL Unique Permissions Result Set** (section [2.2.4.17](#)).

3.1.5.40.12 Empty Result Set

An **Empty Result Set** containing no rows MUST be returned when execution is successful, and all of the following conditions are met:

- *@MetadataFlags* has the **METADATA_WEB** flag set
- *@MetadataFlags* has the **METADATA_WEB_NAVSTRUCT** flag set
- The site specified by *@WebId* does not contain cached navigation scope information, or the site is marked as dirty.

The **Empty Result Set** is defined in the Common Result Sets **Empty Result Set** (section [2.2.4.10](#)).

3.1.5.40.13 Redirect Url Result Set

The **Redirect Url Result Set** contains redirect URL information generated from the *@Url* parameter. If execution is successful, and *@MetadataFlags* has the **METADATA_WEB** flag set and the **METADATA_WEB_WELCOME PAGE** flag set, and the site location specified by *@Url* has a **Redirect Type** (section [2.2.1.2.15](#)) of 255 (None), then **proc_GetTpWebMetaAndListMetaAndData** MUST NOT return this or any further result sets. Otherwise, the **Redirect Url Result Set** MUST be returned when execution is successful, and all of the following conditions are met:

- *@MetadataFlags* has the **METADATA_WEB** flag set
- *@MetadataFlags* has the **METADATA_WEB_WELCOME PAGE** flag set,
- The site location has been marked as a welcome page.

The **Redirect Url Result Set** MUST contain one row with the Redirect URL and related information for the specified site location.

| | |
|-----------------------|----------------|
| {RedirectType} | tinyint, |
| {RedirectUrl} | nvarchar(260), |
| WelcomePageParameters | nvarchar(max); |

{RedirectType}: Type of item this URL is redirected to. See **Redirect Type** for all possible values for this column.

{RedirectUrl}: The store-relative URL generated from the provided *@Url* parameter.

WelcomePageParameters: The URL parameters for the welcome page found with this redirect URL. This column can contain a query string starting with "?" or a hash parameter starting with "#" (or both).

3.1.5.40.14 No Welcome Redirect Url Result Set

The **No Welcome Redirect Url Result Set** contains redirect URL information generated from the `@Url` parameter. The **No Welcome Redirect Url Result Set** MUST be returned when execution is successful, and all of the following conditions are met:

- `@MetadataFlags` has the **METADATA_WEB** flag set
- `@MetadataFlags` has the **METADATA_WEB_WELCOMEPAGE** flag set
- The site location specified by `@Url` has not been marked as a welcome page, that is, it has a **RedirectType** that is not 0

The **No Welcome Redirect Url Result Set** will return exactly one row with the Redirect URL for this folder.

```
{RedirectType}          tinyint,  
{RedirectUrl}          nvarchar(260),  
{WelcomePageParameters} nvarchar(max);
```

{RedirectType}: Type of item this URL is redirected to. See the **Redirect Type** (section [2.2.1.2.15](#)) for all possible values for this column:

{RedirectUrl}: The complete redirect URL generated from the provided `@Url` parameter.

{WelcomePageParameters}: This MUST be NULL and can be ignored.

3.1.5.40.15 List Identifier Result Set

The **List Identifier Result Set** contains identifying information for the file, list or list item specified by `@Url`. If execution is successful, and `@ListId` is NULL, `@MetadataFlags` has the **METADATA_FIGURE_TYPE** flag set, and the site containing `@Url` is not the site specified by `@WebId`, then `proc_GetTpWebMetaDataAndListMetaData` MUST NOT return this or any further result sets. Otherwise, the **List Identifier Result Set** MUST be returned when execution is successful, and all of the following conditions are met:

- `@ListId` is NULL and
- `@MetadataFlags` has the **METADATA_FIGURE_TYPE** flag set and
- `@WebId` is a valid site and contains the file, list or list item specified by `@Url`

```
{ListIdSelected}      uniqueidentifier,  
{TypeSelected}       int,  
{ItemIdSelected}     int;
```

{ListIdSelected}: The **List Identifier** of the specified list, or of the list containing the specified list item. This value MUST be NULL if `@Url` does not specify a list or list item.

{TypeSelected}: Item type value for the specified list. The value of **TypeSelected** MUST be one of the **RedirectType** values specified in **Redirect Type** (section [2.2.1.2.15](#)).

{ItemIdSelected}: **Document Library Row Identifier** of the list item taken from the **Docs View** (section [2.2.6.3](#)) for the list. This value MUST be NULL if `@Url` does not specify a list item.

3.1.5.40.16 List Metadata Result Set

The **List Metadata Result Set** contains the metadata associated with the list specified by *@ListId* or if *@ListId* is NULL, the containing List specified by *@Url*. The **List Metadata Result Set** MUST be returned when execution is successful, and *@ListId* specifies a list or *@Url* specifies a list or list item, and *@MetadataFlags* does not have the **METADATA_LISTMETADATA_NOFETCH** flag set. The **List Metadata Result Set** MUST contain one row if *@WebId* specifies a valid site containing the specified list.

The **List Metadata Result Set** is defined in the Common Result Sets **List Metadata Result Set** (section [2.2.4.14](#)).

3.1.5.40.17 List Related Fields Result Set

The **List Related fields Result Set** returns information about all the relationship lookup fields whose target list is the specified list. The **List Related fields Result Set** MUST return one row for each of the relationship lookup fields whose target list is the specified list. If there are no such fields, then it MUST NOT return any rows.

The **List Related Fields Result Set** is defined in section **List Related Fields Result Set** (section [2.2.4.28](#)), located in the Common Result Sets (section [2.2.4](#)).

3.1.5.40.18 List Unique Permissions Result Set

The **Unique Permissions Result Set** contains all security scope and **WSS ACL** (section [2.2.3.6](#)) information from the specified list. The **Unique Permissions Result Set** MUST be returned when execution is successful, the **List Metadata Result Set** has been returned, and all of the following conditions are met:

- *@MetadataFlags* has the **METADATA_PREFETCH_SCOPES** flag set and
- *@MetadataFlags* has the **METADATA_LISTMETADATA_NOFETCH** flag not set

The **Unique Permissions Result Set** is defined in **Unique Permissions Result Set** (section [2.2.4.26](#)).

3.1.5.40.19 List NULL Unique Permissions Result Set

The **NULL Unique Permissions Result Set** MUST be returned when execution is successful, the **List Metadata Result Set** has been returned, and all of the following conditions are met:

- *@MetadataFlags* has the **METADATA_PREFETCH_SCOPES** flag set
- *@MetadataFlags* has the **METADATA_LISTMETADATA_NOFETCH** flag not set
- Permissions associated with the specified list do not exist

The **NULL Unique Permissions Result Set** is defined in **Unique Permissions Result Set** (section [2.2.4.26](#)).

3.1.5.40.20 Event Receivers Result Set

The **Site Event Receivers Result Set** contains information about the event receivers defined for the site containing the list specified by the *@ListId* parameter, or if the *@ListId* parameter is NULL, the containing list specified by the *@Url* parameter. The **Site Event Receivers Result Set** MUST be returned when execution is successful, and the **List Metadata Result Set** has been returned.

The **Site Event Receivers Result Set** MUST contain one row for each event receiver with an **Event Host Type** (section [2.2.1.2.5](#)) of 2 registered for the site specified by *@WebId*.

The **Site Event Receivers Result Set** is defined in **aa** (section [2.2.4.11](#)), located in the Common Result Sets (section [2.2.4](#)).

3.1.5.40.21 List Web Parts Result Set

The **List Web Parts Result Set** contains information about the List Web Parts defined for the list specified by *@ListId*, or if *@ListId* is NULL, the containing list specified by *@Url*. The **List Web Parts Result Set** MUST be returned when execution is successful, the **List Metadata Result Set** has been returned, and *@MetadataFlags* has the **METADATA_FETCH_VIEWS** flag set.

The **List Web Parts Result Set** MUST contain one row for each Web Part registered for this List.

The **List Web Parts Result Set** is defined in the Common Result Sets **List Web Parts Result Set** (section [2.2.4.15](#)).

3.1.5.40.22 List Metadata Result Set (1)

The **List Metadata Result Set** contains the metadata associated with a specified user information list. The **List Metadata Result Set** MUST be returned when execution is successful, and all of the following conditions are met:

- *@WebSiteId* contains a valid **Site Collection Identifier** and the site collection has a user information list
- The **List Identifier** specified by *@ListId*, or if *@ListId* is NULL, the **List Identifier** of the list at (or that contains) the location specified by *@Url* doesn't match the **List Identifier** for the user information list
- *@MetadataFlags* has the **METADATA_USERINFOLIST** flag set, or *@Url* specifies a list or a location within a list, and
- *@MetadataFlags* doesn't have the **METADATA_USERINFOLIST_NOFETCH** flag set.

The **List Metadata Result Set** MUST contain one row if it is returned.

The **List Metadata Result Set** is defined in the Common Result Sets **List Metadata Result Set** (section [2.2.4.14](#)).

3.1.5.40.23 Unique Permissions Result Set

The **Unique Permissions Result Set** contains all security scope and **WSS ACL** (section [2.2.3.6](#)) information from a specified user information list. The **Unique Permissions Result Set** MUST be returned when execution is successful, and all of the following conditions are met:

- *@WebSiteId* contains a valid **Site Collection Identifier** and the site collection has a user information list
- The **List Identifier** specified by *@ListId*, or if *@ListId* is NULL, the **List Identifier** of the list at (or that contains) the location specified by *@Url* doesn't match the **List Identifier** for the user information list
- *@MetadataFlags* has the **METADATA_USERINFOLIST** flag set, or *@Url* specifies a list or a location within a list, and

- *@MetadataFlags* doesn't have the **METADATA_USERINFOLIST_NOFETCH** flag set
- *@MetadataFlags* has the **METADATA_PREFETCH_SCOPES** flag set

The **Unique Permissions Result Set** is defined in **Unique Permissions Result Set** (section [2.2.4.26](#)).

3.1.5.40.24 NULL Unique Permissions Result Set

The **NULL Unique Permissions Result Set** MUST be returned when execution is successful, and all of the following conditions are met:

- *@WebSiteId* contains a valid **Site Collection Identifier** and the site collection has a user information list
- The **List Identifier** specified by *@ListId*, or if *@ListId* is NULL, the **List Identifier** of the list at (or that contains) the location specified by *@Url* doesn't match the **List Identifier** for the user information list
- *@MetadataFlags* has the **METADATA_USERINFOLIST** flag set, or *@Url* specifies a list or a location within a list, and
- *@MetadataFlags* doesn't have the **METADATA_USERINFOLIST_NOFETCH** flag set
- *@MetadataFlags* has the **METADATA_PREFETCH_SCOPES** flag set
- No unique permissions exist for the root site of the site collection.

The **NULL Unique Permissions Result Set** is defined in the in the Common Result Sets **NULL Unique Permissions Result Set** (section [2.2.4.17](#)).

3.1.5.40.25 Event Receivers Result Set (1)

The **Event Receivers Result Set** contains information about the event receivers defined for the site containing the specified user information list. The **Event Receivers Result Set** MUST be returned when execution is successful, and all of the following conditions are met:

- *@WebSiteId* contains a valid **Site Collection Identifier** and the site collection has a user information list
- The **List Identifier** specified by *@ListId*, or if *@ListId* is NULL, the **List Identifier** of the list at (or that contains) the location specified by *@Url* doesn't match the **List Identifier** for the user information list
- *@MetadataFlags* has the **METADATA_USERINFOLIST** flag set, or *@Url* specifies a list or a location within a list
- *@MetadataFlags* has the **METADATA_USERINFOLIST_FULL** flag set
- *@MetadataFlags* doesn't have the **METADATA_USERINFOLIST_NOFETCH** flag set

The **Event Receivers Result Set** MUST contain one row for each event receiver with an **Event Host Type** (section [2.2.1.2.5](#)) of 2 (List) that is registered for the root site of the site collection specified by *@WebSiteId*.

The **Event Receivers Result Set** is defined in the Common Result Sets **Event Receivers Result Set** (section [2.2.4.11](#)).

3.1.5.40.26 List Web Parts Result Set (1)

The **List Web Parts Result Set** contains information about the Web Parts defined for the specified user information list. The **List Web Parts Result Set** MUST be returned if execution is successful, and all the following conditions are met:

- *@WebSiteId* contains a valid **Site Collection Identifier** and the site collection has a user information list
- The **List Identifier** specified by *@ListId*, or if *@ListId* is NULL, the **List Identifier** of the list at (or that contains) the location specified by *@Url* doesn't match the **List Identifier** for the user information list
- *@MetadataFlags* has the **METADATA_USERINFOLIST** flag set, or *@Url* specifies a list or a location within a list
- *@MetadataFlags* has the **METADATA_USERINFOLIST_FULL** flag set
- *@MetadataFlags* doesn't have the **METADATA_USERINFOLIST_NOFETCH** flag set

The **List Web Parts Result Set** MUST contain one row for each Web Part registered for this List.

The **List Web Parts Result Set** is defined in the Common Result Sets **List Web Parts Result Set** (section [2.2.4.15](#)).

3.1.5.40.27 Document Metadata Result Set

The **Document Metadata Result Set** contains the metadata for a single document when the provided *@Url* parameter refers to a single document. The **Document Metadata Result Set** MUST be returned when execution is successful, and either of the following conditions sets are met:

- *@MetadataFlags* has the **METADATA_URL** flag set
- The document is not contained within a list

OR

- *@MetadataFlags* has the **METADATA_URL_REALLY** flag set

The **Document Metadata Result Set** MUST return one row when *@Url* is valid. The **Document Metadata Result Set** MUST be ordered by the **Id** column, and is defined in the Common Result Sets **Document Metadata Result Set** (section [2.2.4.8](#)).

3.1.5.40.28 NULL Result Set

The **NULL Result Set** returns no data. The **NULL Result Set** MUST be returned if the **Document Metadata Result Set** is not empty, otherwise the **NULL Result Set** MUST NOT be returned. The **NULL Result Set** MUST return zero rows in a schema containing a single unnamed column.

3.1.5.40.29 App Principal Information Result Set

If the *@AppPrincipalName* parameter is not NULL, the **App Principal Info Result Set** MUST be returned as defined in section [2.2.4.29](#).

3.1.5.40.30 App Principal Permissions Result Set

The **App Principal Permissions Result Set** is returned to indicate what permissions the specified app principal has for the site (2) or list (1) as specified in section [2.2.4.30](#). If the specified app principal has permissions for the specified site (2) or list (1), the **App Principal Permissions Result Set** MUST be returned.

3.1.5.41 proc_GetUniqueScopesInList

The **proc_GetUniqueScopesInList** stored procedure is invoked to get the **WSS ACL Format** (section [2.2.3.6](#)) information for all the unique security scopes of folders and list items contained in a specified list.

```
PROCEDURE proc_GetUniqueScopesInList (  
    @SiteId                uniqueidentifier,  
    @WebId                 uniqueidentifier,  
    @ListId                uniqueidentifier,  
    @GetAll                bit,  
    @ThresholdRowCount     int,  
    @RequestGuid           uniqueidentifier =NULL      OUTPUT  
);
```

@SiteId: The **Site Collection Identifier** of the site collection containing the list.

@WebId: The **Site Identifier** of the site that contains the list.

@ListId: The **List Identifier** of the list for which the **WSS ACL Format** information is requested.

@GetAll: A bit specifying whether to fetch **WSS ACL Format** information for all unique security scopes. If this bit is set to "0", **WSS ACL Format** information for most **@ThresholdRowCount** security scopes MUST be returned in the **Unique Permissions Result Set** (section [2.2.4.26](#)), else **WSS ACL Format** information for all unique security scopes MUST be returned in the **Unique Permissions Result Set**.

@ThresholdRowCount: This parameter specifies the number of security scopes to return when **@GetAll** is set to "0". The value MUST not be 0.

@RequestGuid: The optional request identifier for the current request.

Return Values: The **proc_GetUniqueScopesInList** stored procedure returns an integer return code which MUST be 0.

The **proc_GetUniqueScopesInList** stored procedure MUST return a single result set.

3.1.5.41.1 Unique Permissions Result Set

The **Unique Permissions Result Set** returns the **WSS ACL Format** (section [2.2.3.6](#)) information for all the unique security scopes of folders and list items contained in a specified list. The **Unique Permissions Result Set** MUST be returned if the list has 1 or more folders or list items with unique security scopes. The **Unique Permissions Result Set** MUST return one row for every folder or list item with a unique security scope. If the **@GetAll** bit is set to "0", then this result set MUST return at most **@ThresholdRowCount** rows.

The **Unique Permissions Result Set** is defined the Common Result Sets **Unique Permissions Result Set** (section [2.2.4.26](#)).

3.1.5.41.2 NULL Unique Permissions Result Set

The **NULL Unique Permissions Result Set** MUST return one row if the list has no folders or list items with unique security scopes. The **NULL Unique Permissions Result Set** is defined in the Common Result Sets **NULL Unique Permissions Result Set** (section [2.2.4.17](#)).

3.1.5.42 proc_GetVersion

The **proc_GetVersion** stored procedure is invoked to get the component version number string associated with the specified version identifier GUID (using the format major.minor.phase.build; for example, 3.0.106.0).

```
PROCEDURE proc_GetVersion(  
    @VersionId          uniqueidentifier,  
    @Version            nvarchar(64)      OUTPUT  
);
```

@VersionId: The version identifier of the component version number to retrieve.

@Version: An output parameter containing the component version number string that matches the specified version identifier. This value MUST be unchanged from the input value if the specified *@VersionId* value does not have a matching component version number.

Return Values: The **proc_GetVersion** stored procedure MUST return value 0.

The front-end Web server can define one or more version numbers. Each of the version numbers is identified by a version identifier. When a database is created by the front-end Web server on the back-end database server, the front-end Web server stores the version numbers with different version identifiers in the **Versions** table (section [2.2.6.12](#)). When the front-end Web server connects to a back-end database server, the front-end Web server SHOULD retrieve the version identifiers using stored procedure **proc_GetVersion** [<12>](#) and make sure the versions are within an acceptable range defined by the front-end Web server. Otherwise, the front-end Web server MUST NOT connect to the back-end database server.

The version identifiers and the acceptable version numbers for this protocol that are used when communicating with a content database are listed in the following table.

| Version Id GUID | Acceptable version range |
|--|---------------------------------|
| '00000000-0000-0000-0000-000000000000' | 14.0.4006.1010 - 14.0.4006.9999 |
| '6333368D-85F0-4EF5-8241-5252B12B2E50' | 4.0.116.0 - 4.0.116.0 |
| '1A707EF5-45B2-4235-9327-021E5F9B8BB0' | 4.0.6.0 - 4.0.6.0 |
| '25EB5CEE-15BD-4954-BD4E-2624D5878D8C' | 14.0.4006.1010 - 14.0.4006.9999 |

When the protocol is used to communicate with a configuration database, the list of version identifiers used are the following.

| Version Id GUID | Acceptable version range |
|--|---------------------------------|
| '00000000-0000-0000-0000-000000000000' | 14.0.4006.1010 - 14.0.4006.9999 |
| 'F4D348C4-A6E9-4ed5-BDB2-2358B74EF902' | 4.0.116.0 - 4.0.116.0 |

| Version Id GUID | Acceptable version range |
|--|--------------------------|
| '60B1F2BE-5130-45AB-AF1D-EDD34E626B5D' | 4.0.6.0 - 4.0.6.0 |

The acceptable version numbers specified in the preceding tables can change when the front-end Web server is updated. As a result, the updated front-end Web server might not be able to communicate with the back-end database server. To re-enable front-end Web server to back-end database server communication, the front-end Web server MUST use an upgrade process to modify any data structure on the back end database server to accommodate any changes that might have occurred to this protocol, and to update the version numbers to match the new acceptable version numbers. Upgrade logic is implementation-specific.

The **proc_GetVersion** stored procedure MUST NOT return any result sets.

3.1.5.43 proc_GetWebMetaInfo

The **proc_GetWebMetaInfo** stored procedure is invoked to request metadata information for a site (2).

```

PROCEDURE proc_GetWebMetaInfo (
    @WebSiteId                uniqueidentifier,
    @WebDirName               nvarchar(256),
    @WebLeafName              nvarchar(128),
    @DGCacheVersion           bigint,
    @SystemId                 varbinary(512) = NULL,
    @AppPrincipalName         nvarchar(256),
    @IsHostHeaderAppPrincipalName bit,
    @RequestGuid              uniqueidentifier = NULL OUTPUT
);

```

@WebSiteId: The site collection identifier for the site collection containing the site (2) whose metadata is requested.

@WebDirName: The directory name part of the site location.

@WebLeafName: The leaf name part of the site location.

@DGCacheVersion: The version number of the domain group map cache in the front-end Web server. This can be compared with the domain group map cache version number on the back-end database server returned in the **Domain Group Cache Versions Result Set** (section [3.1.5.43.2](#)) to determine whether updates are needed. If the **@DGCacheVersion** parameter is set to -2, then the information about the domain group map cache is not requested, and the **Domain Group Cache BEDS Update Result Set** (section [3.1.5.43.3](#)) and the **Domain Group Cache WFE Update Result Set** (section [3.1.5.43.4](#)) MUST NOT be returned.

@SystemId: The **SystemID** of the current user requesting the site metadata information.

@AppPrincipalName: The app principal identifier or the application web domain Id associated with the current user. If the current user is not associated with an application principal, this parameter MUST be NULL.

@IsHostHeaderAppPrincipalName: If this parameter is set to "1", the **@AppPrincipalName** parameter MUST be the app principal identifier; otherwise, it MUST be the application web domain Id.

@RequestGuid: The optional request identifier for the current request.

Return Values: This stored procedure returns an integer return code, which MUST be listed in the following table.

| Value | Description |
|-------|--|
| 0 | Successful execution. |
| 3 | A site (2) was not found at the specified location. |
| 1271 | The site collection is locked for read and write operations. |

Result Sets: This stored procedure MUST return result sets as described in the following sections: **Site MetaInfo Result Set** (section [3.1.5.43.1](#)), **Domain Group Cache Versions Result Set** (section [3.1.5.43.2](#)), **Domain Group Cache BEDS Update Result Set** (section [3.1.5.43.3](#)), **Domain Group Cache WFE Update Result Set** (section [3.1.5.43.4](#)), **Site Metadata Result Set** (section [3.1.5.43.5](#)), and **Event Receivers Result Set** (section [3.1.5.43.6](#)).

3.1.5.43.1 Site MetaInfo Result Set

The **Site MetaInfo Result Set** MUST be returned. The **Site MetaInfo Result Set** MUST contain a single row containing the metainfo for a valid site. If the specified site is not found, zero rows MUST be returned and the stored procedure MUST NOT return any more result sets. The **Site MetaInfo Result Set** is defined in section **Site MetaInfo Result Set** (section [2.2.4.25](#)), located in the Common Result Sets (section [2.2.4](#)).

3.1.5.43.2 Domain Group Cache Versions Result Set

The **Domain Group Cache Versions Result Set** contains information about the version numbers associated with the domain group map caches on the front-end Web server and on the back-end database server for the specified site collection.

The **Domain Group Cache Versions Result Set** MUST be returned if the specified site is found, and MUST contain one row of version number data. If the value specified by the *@DGCacheVersion* parameter is set to -2, then all columns returned MUST have the value -2, indicating that the value MUST NOT be used for comparison. The **Domain Group Cache Versions Result Set** is defined in section **Domain Group Cache Versions Result Set** (section [2.2.4.4](#)), located in the Common Result Sets (section [2.2.4](#)).

3.1.5.43.3 Domain Group Cache BEDS Update Result Set

The **Domain Group Cache BEDS Update Result Set** contains information to be used in recomputing the domain group map cache.

The **Domain Group Cache BEDS Update Result Set** returns only if the **Domain Group Cache Versions Result Set** (section [3.1.5.43.2](#)) is returned and the *@DGCacheVersion* parameter is not set to -2 and the real domain group version is more recent than the cached version. (The value of **RealVersion** is greater than the value of **CachedVersion** in the **Domain Group Cache Versions Result Set**).

If the **Domain Group Cache BEDS Update Result Set** is returned, then it indicates that the database's copy of the domain group map cache is out of date.

When returned, the **Domain Group Cache BEDS Update Result Set** MUST contain one row for each domain group that is a member of a permission level in the site collection, ordered by the **User Identifier** (section [2.2.1.1.13](#)) of the domain groups.

This result set is defined in section **Domain Group Cache BEDS Update Result Set** (section [2.2.4.3](#)), located in the Common Result Sets (section [2.2.4](#)).

3.1.5.43.4 Domain Group Cache WFE Update Result Set

The **Domain Group Cache WFE Update Result Set** contains the binary data needed to refresh the domain group map cache.

The **Domain Group Cache WFE Update Result Set** returns only if the **Domain Group Cache Versions Result Set** is returned and the `@DGCacheVersion` parameter is not set to -2 and the cached version is up to date (the value of **RealVersion** is not greater than the value of **CachedVersion** in the **Domain Group Cache Versions Result Set**).

If the **Domain Group Cache WFE Update Result Set** is returned, one row MUST be returned. The **Domain Group Cache WFE Update Result Set** is defined in section **Domain Group Cache WFE Update Result Set** (section [2.2.4.5](#)), located in the Common Result Sets (section [2.2.4](#)).

3.1.5.43.5 Site Metadata Result Set

The **Site Metadata Result Set** contains metadata for the specified site.

The **Site Metadata Result Set** MUST be returned if the specified site is found, and MUST contain a single row corresponding to the specified site. If the site is locked from both read and write operations, the stored procedure MUST NOT return any more result sets.

The **Site Metadata Result Set** is defined in section **Site Metadata Result Set** (section [2.2.4.24](#)), located in the Common Result Sets (section [2.2.4](#)).

3.1.5.43.6 Event Receivers Result Set

The **Event Receivers Result Set** contains information about the event receivers defined for the specified site. There MUST be one row in the **Event Receivers Result Set** for each event receiver that is registered for this site. The **Event Receivers Result Set** MUST be returned on successful execution.

The **Event Receivers Result Set** is defined in section **Event Receivers Result Set** (section [2.2.4.11](#)), located in the Common Result Sets (section [2.2.4](#)).

3.1.5.44 proc_GetWebMetainfoByUrl

The **proc_GetWebMetainfoByUrl** stored procedure is invoked to request site metadata information for the site (2) containing a specified Uniform Resource Locator (URL).

```
PROCEDURE proc_GetWebMetainfoByUrl (
    @WebSiteId          uniqueidentifier,
    @Url                nvarchar(260),
    @DGCacheVersion    bigint,
    @SystemId          varbinary(512) = NULL,
    @AppPrincipalName  nvarchar(256),
    @IsHostHeaderAppPrincipalName bit,
    @RequestGuid       uniqueidentifier = NULL OUTPUT
);
```

`@WebSiteId`: The **Site Collection Identifier** (section [2.2.1.1.9](#)) for the site collection containing the site (2) or document whose metadata is requested.

@Url: A URL in store-relative form for the site (2) or for a document within the site (2).

@DGCacheVersion: The version number of the Domain Group Map Cache in the front-end Web server. This can be compared with the Domain Group Map Cache version number on the back-end database server returned in the **Domain Group Cache Versions Result Set** (section [3.1.5.44.3](#)) to determine whether updates are needed. If the **@DGCacheVersion** parameter is set to "-2", then information about the Domain Group Map Cache is not requested, and the **Domain Group Cache BEDS Update Result Set** (section [3.1.5.44.4](#)) and the **Domain Group Cache WFE Update Result Set** (section [3.1.5.44.5](#)) MUST NOT be returned.

@SystemId: The SystemID of the current user requesting the site metadata information.

@AppPrincipalName: The app principal identifier or the application web domain Id associated with the current user. If the current user is not associated with an application principal, this parameter MUST be NULL.

@IsHostHeaderAppPrincipalName: If this parameter is set to "1", the **@AppPrincipalName** parameter MUST be the app principal identifier; otherwise, it MUST be the application web domain Id.

@RequestGuid: The optional request identifier for the current request.

Return Values: This stored procedure returns an integer return code, which MUST be listed in the following table.

| Value | Description |
|-------|---|
| 0 | Successful execution. |
| 1168 | The site collection does not exist. |
| 1271 | The site (2) is locked for read and write operations. |

This stored procedure MUST return 0, 5, or 6 result sets. Some of the result sets are returned conditionally, and all result sets returned will be sent in the order specified in the following sections.

3.1.5.44.1 Site URL Result Set

The **Site URL Result Set** MUST be returned if the values for the **@Url** and **@WebSiteId** parameters are valid. Otherwise, the stored procedure MUST NOT return any result sets. The **Site URL Result Set** MUST contain a single row. The T-SQL syntax for the result set is as follows:

```
{WebUrl}                nvarchar(260),  
{AppWebDomainId}       varchar(8);
```

{WebUrl}: The URL in store-relative form of the site (2) that contains the URL specified in the **@Url** parameter.

{AppWebDomainId}: The application web domain Id associated with the site (2) that contains the URL specified in the **@Url** parameter. This MAY be NULL.

3.1.5.44.2 Site MetaInfo Result Set

The **Site MetaInfo Result Set** MUST contain a single row containing the metaInfo for the site (2).

For details about the **Site MetaInfo Result Set**, see section [2.2.4.25](#).

3.1.5.44.3 Domain Group Cache Versions Result Set

The **Domain Group Cache Versions Result Set** contains information about the version numbers associated with the domain group map caches on the front-end Web server and on the back-end database server for the specified site collection.

The **Domain Group Cache Versions Result Set** MUST contain one row of version number data. If the value specified for the `@DGCacheVersion` parameter is set to "-2", then all columns returned MUST have the value "-2", indicating that the value MUST NOT be used for comparison. The **Domain Group Cache Versions Result Set** is defined in section [2.2.4.4](#).

3.1.5.44.4 Domain Group Cache BEDS Update Result Set

The **Domain Group Cache BEDS Update Result Set** contains information to be used in recomputing the domain group map cache, which contains the mapping of domain groups to the site permission levels of which they are members. The presence of the **Domain Group Cache BEDS Update Result Set** means the database's copy of the domain group map cache is out of date.

The **Domain Group Cache BEDS Update Result Set** MUST be returned if the `@DGCacheVersion` parameter does not equal "-2" and the value of **RealVersion** is greater than the value of **CachedVersion** in the results of the **Domain Group Cache Versions Result Set**. Otherwise, this result set MUST NOT be returned.

If the **Domain Group Cache BEDS Update Result Set** is returned, it MUST contain one row for each domain group that is a member of a site permission level in the site collection, ordered by the **User Identifier** (section [2.2.1.1.13](#)) of the domain groups.

This result set is defined in section [2.2.4.3](#).

3.1.5.44.5 Domain Group Cache WFE Update Result Set

The **Domain Group Cache WFE Update Result Set** contains the binary data needed to refresh the domain group map cache. If the **Domain Group Cache WFE Update Result Set** is returned, then it indicates that the back-end database server Domain Group map cache is up to date, and the front-end Web server cache can be refreshed if necessary.

The **Domain Group Cache WFE Update Result Set** MUST be returned on successful determination of the site (2) if the `@DGCacheVersion` parameter is not set to "-2" and the value of **RealVersion** is less than or equal to the value of **CachedVersion** in the results of the **Domain Group Cache Versions Result Set**. Otherwise, the **Domain Group Cache WFE Update Result Set** MUST NOT be returned.

If the **Domain Group Cache WFE Update Result Set** is returned, it MUST contain one row.

The **Domain Group Cache WFE Update Result Set** is defined in section [2.2.4.5](#).

3.1.5.44.6 Site Metadata Result Set

The **Site Metadata Result Set** contains specialized site metadata. If the site (2) is locked for read and write operations, the stored procedure MUST NOT return any more result sets. There MUST be one row in the **Site Metadata Result Set**.

The **Site Metadata Result Set** is defined in section [2.2.4.24](#).

3.1.5.44.7 Event Receivers Result Set

The **Event Receivers Result Set** contains information about the event receivers defined for this site (2). There MUST be one row in the **Event Receivers Result Set** for each event receiver registered for this site (2). The **Event Receivers Result Set** MUST be returned on successful completion.

The **Event Receivers Result Set** is defined in section [2.2.4.11](#).

3.1.5.45 proc_ListDocumentVersions

The **proc_ListDocumentVersions** stored procedure is invoked to list all available version history information for a specified document.

```
PROCEDURE proc_ListDocumentVersions(  
    @DocSiteId                uniqueidentifier,  
    @DocWebId                 uniqueidentifier,  
    @DocDirName               nvarchar(256),  
    @DocLeafName              nvarchar(128),  
    @MaxLevel                 tinyint,  
    @UserId                   int,  
    @RequestGuid              uniqueidentifier = NULL OUTPUT  
);
```

@DocSiteId: The **Site Collection Identifier** (section [2.2.1.1.9](#)) of the site collection containing the document.

@DocWebId: The **Site Identifier** (section [2.2.1.1.11](#)) of the site containing the document.

@DocDirName: The directory name containing the document.

@DocLeafName: The leaf name containing the document.

@MaxLevel: A **Publishing Level Type** (section [2.2.2.6](#)) indicating the maximum publishing level value of the document that SHOULD be returned to the front-end Web server in the **Document Versions Result Set** (section [3.1.5.45.3](#)) if multiple publishing levels of the document are available. See the **@UserId** parameter for an exception to this.

@UserId: This parameter is the **User Identifier** (section [2.2.1.1.13](#)) of the current user. If the current user is the owner of one or more versions of the document at any publishing level, the version information MUST be returned in the **Document Versions Result Set**, ignoring the value specified in the **@MaxLevel** parameter.

@RequestGuid: The optional request identifier for the current request.

Return Values: This stored procedure returns an integer return code, which MUST be included in the following table.

| Value | Description |
|-------|--|
| 0 | Successful execution. |
| 2 | The document specified is not a file (that is, it does not have a Document Store Type (section 2.2.2.4) of 0). |

This stored procedure MUST return two or three result sets upon successful completion.

3.1.5.45.1 Individual URL Security Result Set

The **Individual URL Security Result Set** contains security information about the specified document. If the document does not exist, but the specified document URL is within a list or document library, security information is returned from the document's parent object, such as the list or document library within which it would be contained within.

The **Individual URL Security Result Set** MUST only be returned if the document URL is contained within a list or document library. Otherwise, the **NULL Individual URL Security Result Set** (section [3.1.5.45.2](#)) MUST be returned instead. If returned, the **Individual URL Security Result Set** MUST contain a single row.

The **Individual URL Security Result Set** is defined in section **Individual URL Security Result Set** (section [2.2.4.12](#)), located in the Common Result Sets (section [2.2.4](#)).

3.1.5.45.2 NULL Individual URL Security Result Set

The **NULL Individual URL Security Result Set** indicates that the specified document URL is not contained within a list or document library. The **NULL Individual URL Security Result Set** MUST only be returned if the document URL is not contained within a list or document library.

The **NULL Individual URL Security Result Set** MUST return a single row and is defined in section **NULL Individual URL Security Result Set** (section [2.2.4.16](#)), located in the Common Result Sets (section [2.2.4](#)).

3.1.5.45.3 Document Versions Result Set

The **Document Versions Result Set** returns version information for a specified document. The **Document Versions Result Set** MUST only be returned when the specified document has a **Document Store Type** (section [2.2.2.4](#)) of 0. The **Document Versions Result Set** MUST contain document version information corresponding to publishing levels less than or equal to the specified publishing level, or corresponding to any publishing levels owned by the current user.

| | |
|----------------|-----------------|
| TimeCreated | datetime, |
| VersionNumber | int, |
| Size | int, |
| CheckinComment | nvarchar(1023), |
| MetaInfo | varbinary(max), |
| {IsTip} | bit, |
| Level | tinyint, |
| DraftOwnerId | int, |
| StreamSchema | tinyint, |
| {NextBSN} | bigint; |

TimeCreated: A timestamp in UTC format specifying when this document was created.

VersionNumber: A counter incremented any time a change is made to this document, used for internal conflict detection.

Size: The number of bytes in the document stream.

CheckinComment: An optional user-provided description used when a document is being checked in or published. This value MUST be NULL for documents that have not been checked in or published.

MetaInfo: A metadict for the document. The metadict format is specified in [\[MS-FPSE\]](#) section 2.2.2.2.11.

{IsTip}: If set to 1, the document is a current version, otherwise it is a historical version.

Level: A **Publishing Level Type** (section [2.2.2.6](#)) value specifying the publishing level of the document.

DraftOwnerId: The user that published this document as a draft. This value is only non-NULL if the document is a draft version. See **Publishing Level Type** for more information regarding the different publishing levels.

StreamSchema: The current stream schema of the document being returned.

{NextBSN}: The current BLOB sequence number of the document being returned.

3.1.5.46 **proc_ListRbsStores**

The **proc_ListRbsStores** stored procedure is invoked to enumerate the remote BLOB storage stores with which the back-end database server has been configured, if any.

```
PROCEDURE proc_ListRbsStores (  
    @RequestGuid uniqueidentifier = null OUTPUT,  
);
```

@RequestGuid: The optional request identifier for the current request.

Return values:

| Value | Description |
|-------|----------------------|
| 0 | Default return value |

Result Sets:

This procedure MUST return the **List RBS Stores Result Set**.

3.1.5.46.1 **List RBS Stores Result Set**

```
blob_store_name nvarchar(128) NOT NULL,
```

blob_store_name: A remote BLOB storage store name with which the BEDS has been configured.

3.1.5.47 **proc_ListUrls**

The **proc_ListUrls** stored procedure retrieves metadata for a document specified by a URL and the documents contained within it, if any.

```
PROCEDURE proc_ListUrls(  
    @DirSiteId uniqueidentifier,  
    @DirWebId uniqueidentifier,  
    @DirFullUrl nvarchar(260),  
    @AttachmentsFlag tinyint,  
    @ClientTimeStamp datetime,
```

```

@FetchLinkInfo          bit,
@IncludeThicketDirs     bit,
@IncludeListItems       bit,
@UserId                 int,
@ItemLimit              int,
@RequestGuid            uniqueidentifier = NULL OUTPUT
);

```

@DirSiteId: The **Site Collection Identifier** (section [2.2.1.1.9](#)) of the site collection containing the document specified by a URL.

@DirWebId: The **Site Identifier** (section [2.2.1.1.11](#)) of the site (2) containing the document.

@DirFullUrl: The URL in store-relative form specifying the document.

@AttachmentsFlag: An **Attachments Flag** (section [2.2.1.2.1](#)) value specifying whether the document is, or is contained within, a folder for attachments.

@ClientTimeStamp: A **datetime** that specifies a limiting time on the data in the result sets returned. See the description of the result sets in the following sections for the specific effects of this parameter value.

@FetchLinkInfo: A bit flag specifying whether to return the **Link Info Result Set** (section [3.1.5.47.6](#)). If this parameter is set to 1 and the specified document is a folder, the **Link Info Result Set** MUST be returned.

@IncludeThicketDirs: A bit flag specifying whether to return **thicket folders** in the **Contained Document Metadata Result Set** (section [3.1.5.47.7](#)). If this parameter is set to 1 and the specified document is a folder, any thicket folders MUST be included in the **Contained Document Metadata Result Set**.

@IncludeListItems: A bit flag specifying whether to include list items which are files in the **Link Info Result Set** and the **Contained Document Metadata Result Set**. If this parameter is set to 1 and the document is a folder, list items with a **Document Store Type** (section [2.2.2.4](#)) of 0 MUST be included in the **Link Info Result Set** and the **Contained Document Metadata Result Set**.

@UserId: The **User Identifier** (section [2.2.1.1.13](#)) for the current user.

@ItemLimit: This parameter MUST be ignored if set to a value that is less than or equal to 0. Otherwise, if this parameter is greater than 0 and the document specified by the **@DirFullUrl** parameter contains a sum total of list items and folders that exceed the value specified by this parameter, the stored procedure MUST fail execution. See the below Return Values for more information.

@RequestGuid: The optional request identifier for the current request.

Return Values: This stored procedure returns an integer return code that MUST be in the following table.

| Value | Description |
|-------|---|
| 0 | Successful execution. |
| 3 | The document URL is not valid, or the document is not a folder or site. |
| 36 | The stored procedure failed to complete successfully. This value is returned if the @ItemLimit parameter is greater than 0, this list (1) is not exempt from resource throttling operations, and |

| Value | Description |
|-------|---|
| | the number of list items combined with the number of folders in the list (1) exceeds the <i>@ItemLimit</i> parameter. |

This stored procedure MUST return two to six result sets, as described in the following sections, in the following order.

3.1.5.47.1 Individual URL Security Result Set

The **Individual URL Security Result Set** contains security information about the specified document. If the document does not exist, but the specified document URL is within a list (1) or document library, security information is returned from the document's parent object, such as the list (1) or document library within which it would be contained.

The **Individual URL Security Result Set** MUST only be returned if the document URL is contained within a list (1) or document library. Otherwise, the **NULL Individual URL Security Result Set** MUST be returned instead. If returned, the **Individual URL Security Result Set** MUST contain a single row.

The result set is defined in **Individual URL Security Result Set** (section [2.2.4.12](#)), located in the Common Result Sets (section [2.2.4](#)).

3.1.5.47.2 NULL Individual URL Security Result Set

The **NULL Individual URL Security Result Set** indicates that the specified document URL is not contained within a list (1) or document library. The **NULL Individual URL Security Result Set** MUST only be returned if the document URL is not contained within a list (1) or document library.

The result set MUST return a single row and is defined in **NULL Individual URL Security Result Set** (section [2.2.4.16](#)), located in the Common Result Sets (section [2.2.4](#)).

3.1.5.47.3 Server Time Result Set

The **Server Time Result Set** returns the current time from the back-end database server in UTC. The **Server Time Result Set** MUST be returned and MUST contain a single row of data.

The result set is defined in **Server Time Result Set** (section [2.2.4.20](#)), located in the Common Result Sets (section [2.2.4](#)).

3.1.5.47.4 Subsite List Result Set

The **Subsite List Result Set** contains an unordered list of URLs in store-relative form for all subsites whose parent site is the site (2) specified by the *@DirWebId* parameter.

If the specified document is not a folder, the **Subsite List Result Set** MUST NOT be returned. Otherwise the **Subsite List Result Set** MUST be returned and MUST contain one row for each subsite within the specified site (2), and it MUST contain no rows if there are no such subsites.

The result set is defined in **URL Result Set** (section [2.2.4.27](#)), located in the Common Result Sets (section [2.2.4](#)).

3.1.5.47.5 Document Metadata Result Set

The **Document Metadata Result Set** contains the metadata for the specified document. If the document is not a folder or if the *@DirFullUrl* parameter contains an empty string, the **Document Metadata Result Set** MUST NOT be returned. Otherwise, the **Document Metadata Result Set** MUST contain one row with the metadata information for the document.

| | |
|--------------------------|-------------------|
| Id | uniqueidentifier, |
| {FullUrl} | nvarchar(260), |
| Type | tinyint, |
| MetaInfoTimeLastModified | datetime, |
| MetaInfo | varbinary(max), |
| Size | int, |
| TimeCreated | datetime, |
| TimeLastModified | datetime, |
| ETagVersion | int, |
| DocFlags | int, |
| {ListType} | int, |
| tp_Name | nvarchar(38), |
| {ListTitle} | nvarchar(255), |
| CacheParseId | uniqueidentifier, |
| {GhostDirName} | nvarchar(256), |
| {GhostLeafName} | nvarchar(128), |
| {tp_Login} | nvarchar(255), |
| {CheckoutDate} | datetime, |
| {CheckoutExpires} | datetime, |
| VirusStatus | int, |
| VirusInfo | nvarchar(255), |
| SetupPathVersion | tinyint, |
| SetupPath | nvarchar(255), |
| SetupPathUser | nvarchar(255), |
| NextToLastTimeModified | datetime, |
| UIVersion | int, |
| CheckinComment | nvarchar(1023), |
| WelcomePageUrl | nvarchar(260), |
| WelcomePageParameters | nvarchar(max), |
| tp_Flags | bigint, |
| Acl | varbinary(max), |
| AnonymousPermMask | bigint, |
| DraftOwnerId | int, |
| Level | tinyint, |
| ParentVersion | int, |
| TransformerId | uniqueidentifier, |
| ParentLeafName | nvarchar(128), |
| ProgId | nvarchar(255), |
| DoclibRowId | int, |
| tp_DefaultWorkflowId | uniqueidentifier, |
| ListId | uniqueidentifier, |
| ItemChildCount | int, |
| FolderChildCount | int, |
| MetaInfoVersion | int, |
| {CurVerMetaInfo} | varbinary(max), |
| ContentVersion | int, |
| IsDirty | bit, |
| {NextBSN} | bigint, |
| {StreamSchema} | tinyint, |
| {InternalVersion} | int |

Id: The **Document Identifier** (section [2.2.1.1.2](#)) of the document.

{FullUrl}: The URL in store-relative form for the document.

Type: The **Document Store Type** (section [2.2.2.4](#)) of the document.

MetaInfoTimeLastModified: A datetime with a timestamp in UTC format specifying the last time the **MetaInfo** column value of the document was changed. This value MUST be NULL if the **MetaInfo** column value of the document has never been changed.

MetaInfo: A metadict for the document. The metadict format is specified in [\[MS-FPSE\]](#) section 2.2.2.2.11. This value MUST be NULL if the document does not have any metadict associated with it.

Size: The number of bytes in the document stream of the document. This value MUST be NULL if the document does not have a document stream.

TimeCreated: A **datetime** with a timestamp in UTC format specifying when the document was created.

TimeLastModified: A **datetime** with a timestamp in UTC format specifying when the document was last modified.

ETagVersion: A counter used for internal conflict detection that is incremented any time a change is made to the document.

DocFlags: A **Doc Flags** value (section [2.2.2.3](#)) describing the document. This value MUST be NULL if the document does not have any **Doc Flags** associated with it.

{ListType}: A packed combination of the **List Base Type** (section [2.2.1.2.11](#)) and **List Server Template** (section [2.2.1.2.12](#)) values of the list containing this document, consisting of the **List Server Template** value multiplied by 256 and added to the value of the **List Base Type**.

tp_Name: The **List Identifier** (section [2.2.1.1.5](#)) of the list (1) containing this document.

{ListTitle}: If the document URL is the root folder of a list (1), this contains the display name of the list (1). Otherwise, this value MUST be NULL.

CacheParseId: This value MUST be NULL.

{GhostDirName}: This value MUST be NULL.

{GhostLeafName}: This value MUST be NULL.

{tp_Login}: This value MUST be NULL.

{CheckoutDate}: This value MUST be NULL.

{CheckoutExpires}: This value MUST be NULL.

VirusStatus: A **Virus Status** (section [2.2.1.2.17](#)) value specifying the current virus state of the document. This value can be NULL if the document has not been processed by a virus scanner.

VirusInfo: A string containing a provider-specific message returned by the virus scanner when it last processed the document. This value can be NULL if the document has not been processed by a virus scanner.

SetupPathVersion: If this is an uncustomized document, this specifies the setup path location that the **SetupPath** fragment is relative to. This value MUST NOT be NULL. The following are valid values.

| Value | Description |
|-------|---|
| 2 | The SetupPath is relative to the install location of WSS2 on the front-end Web server (for example, Program Files\Common Files\Microsoft Shared\Web Server Extensions\60). |
| 3 | The SetupPath is relative to the install location of WSS3 on the front-end Web server (for example, Program Files\Common Files\Microsoft Shared\Web Server Extensions\12). |
| 4 | The SetupPath is relative to the install location of WSS4 on the front-end Web server (for example, Program Files\Common Files\Microsoft Shared\Web Server Extensions\14). |
| 15 | The SetupPath is relative to the install location of Microsoft SharePoint Foundation 2013 on the front-end Web server (for example, Program Files\Common Files\Microsoft Shared\Web Server Extensions\15). |

SetupPath: If the document is now or once was uncustomized, this contains the setup path fragment relative to the base setup path described above by the **SetupPathVersion** value where the document stream of the document can be found. This value can be NULL.

SetupPathUser: If the document is now or once was uncustomized, this contains the login name of the user who created the uncustomized document. This value can be NULL.

NextToLastTimeModified: The value of **TimeLastModified** from the previous time when the document was last saved. If the **NextToLastTimeModified** value matches the **TimeLastModified** value when the change occurred and the client has a version of the document that it has successfully modified, the client can safely submit the document to the server despite what appears to be an intervening edit to the document. This value MUST be NULL if the document has never been saved.

UIVersion: The UI version number for the document.

CheckinComment: An optional user-supplied description provided when the document is checked in or published. This value can be NULL.

WelcomePageUrl: If the document is a folder, this specifies an optional page to redirect to when the folder is requested with an HTTP GET operation. The URL is relative to the URL of the folder itself, and MUST be contained within that folder. Attempts to break out of the folder, such as ".././somepage.aspx", are not valid. This value can be NULL.

WelcomePageParameters: Contains optional URL parameters to specify as part of the **WelcomePageUrl** value. These parameters start at either the query string signifier '?' or the bookmark signifier '#'. This value can be NULL.

tp_Flags: The **List Flags** value (section [2.2.2.5](#)) for the list (1) that contains the document.

Acl: The binary serialization of the **WSS ACL Format** (section [2.2.3.6](#)) for the document. The WSS ACL is either explicitly defined for the document or inherited from the parent object of the document. This value can be NULL.

AnonymousPermMask: A **WSS Rights Mask** (section [2.2.2.15](#)) that indicates the permissions granted anonymous users or those users that have no specific permissions to the document. This value can be NULL if anonymous access to the document is not allowed.

DraftOwnerId: The **User Identifier** (section [2.2.1.1.13](#)) of the user that published the document as a draft. This value MUST be NULL if the document is not a draft version.

Level: A **Publishing Level Type** value (section [2.2.2.6](#)) specifying the publishing status of the document.

ParentVersion: If the document is a transformed version of another document, this is the UI version value from the original document. This value MUST be NULL if the document is not the product of a document transformation.

TransformerId: If the document is a transformed version of another document, this is the GUID of the agent that performed the transformation. This value MUST be NULL if the document is not the product of a document transformation.

ParentLeafName: If the document is a transformed version of another document, this is the leaf name of the original document. The original document MUST be in the same folder as the transformed document. If either is moved, the relationship is broken. This value MUST be NULL if the document is not the product of a document transformation.

ProgId: Specifies a preferred application to open the document. The **ProgId** value is used to distinguish between different applications that save files with a given file extension (for example, different editors for .HTML or .XML files). This value MUST be NULL if a **ProgId** was not specified when the document was saved.

DoclibRowId: The identifier for a row in a document library for the document. If the document is not contained in a list (1), this value MUST be NULL.

tp_DefaultWorkflowId: The **Workflow Identifier** (section [2.2.1.1.16](#)) corresponding to the workflow (2) to be invoked if the document is in a moderated list (1) and the document is submitted for approval as part of a check in.

ListId: The list identifier of the list (1) that contains the document. If the document is not contained in a list (1), this value MUST be NULL.

ItemChildCount: The value MUST be the number of list items for the list (1) that contains the document.

FolderChildCount: The value MUST be the number of folders that exist in the list (1) that contains the document.

MetaInfoVersion: A counter used for internal conflict detection that is incremented any time a change is made to the **MetaInfo** for this document.

{CurVerMetaInfo}: The value MUST be NULL.

ContentVersion: The version number of the document stream being returned.

IsDirty: A bit that specifies this document MUST have implementation-specific processing performed before its stream (1) can be returned. If this document does not require processing, this value MUST be zero.

{NextBSN}: The current BLOB sequence number of the document being returned.

{StreamSchema}: The current stream schema of the document being returned.

{InternalVersion}: The internal version number of the document being returned.

3.1.5.47.6 Link Info Result Set

The **Link Info Result Set** returns information about all forward links from and backward links to the documents contained within the specified document. If the specified document is not a folder, or the `@FetchLinkInfo` parameter is not set to 1, then the **Link Info Result Set** MUST NOT be returned. Otherwise, if the document is a folder and the `@FetchLinkInfo` parameter is set to 1, then the **Link Info Result Set** MUST be returned. The **Link Info Result Set** MUST contain one row for each link that has been modified after the value in the `@ClientTimeStamp` parameter for each contained document in the site collection which has its directory name equal to the value of the `@DirFullUrl` parameter, and the contained document has a **Document Store Type** (section 2.2.2.4) of 0 and the `@IncludeListItems` parameter is set to 1, the document is in a document library, or the document can have a document stream, and for forward links, is a published or draft version which is not checked out to the specified user, or is a checked out version which is checked out to the user.

The **Link Info Result Set** is defined using T-SQL syntax as described in section section 2.2.4.21, located in the Common Result Sets (section 2.2.4).

3.1.5.47.7 Contained Document Metadata Result Set

The **Contained Document Metadata Result Set** contains the metadata information for the documents contained within the specified document. If the specified document is not a folder, the **Contained Document Metadata Result Set** MUST NOT be returned. Otherwise, the **Contained Document Metadata Result Set** MUST return one row for each document that matches the following conditions:

- It belongs to site collection whose directory name is equal to the value of the `@DirFullUrl` parameter.
- Either:
 - It is a published or draft version which is not checked out to the specified user.
 - Or, it is a checked out version which is checked out to the user.
- Either:
 - The contained document has a **Document Store Type** (section 2.2.2.4) of zero and the `@IncludeListItems` parameter is set to one, or the document is in a document library, or the document can have a document stream.
 - Or, the contained document is a folder, and the folder is not a thicket supporting file, and either the folder is not a thicket folder or the `@IncludeThicketDirs` parameter is set to one.
- Either:
 - The app web domain identifier of the site (2) containing the document is equal to the app web domain identifier of the site (2) whose identifier is equal to `@DirWebId` parameter.
 - Or, both site (2) containing the document and the site (2) whose identifier is equal to `@DirWebId` parameter, don't have app web domain identifier.

| | |
|--------------------------|-------------------|
| Id | uniqueidentifier, |
| {FullUrl} | nvarchar(260), |
| Type | tinyint, |
| MetaInfoTimeLastModified | datetime, |
| MetaInfo | varbinary(max), |

| | |
|------------------------|-------------------|
| Size | int, |
| TimeCreated | datetime, |
| TimeLastModified | datetime, |
| ETagVersion | int, |
| DocFlags | int, |
| {ListType} | int, |
| tp_Name | nvarchar(38), |
| {ListTitle} | nvarchar(255), |
| CacheParseId | uniqueidentifier, |
| {GhostDirName} | nvarchar(256), |
| {GhostLeafName} | nvarchar(128), |
| tp_Login | nvarchar(255), |
| CheckoutDate | datetime, |
| CheckoutExpires | datetime, |
| VirusStatus | int, |
| VirusInfo | nvarchar(255), |
| SetupPathVersion | tinyint, |
| SetupPath | nvarchar(255), |
| SetupPathUser | nvarchar(255), |
| NextToLastTimeModified | datetime, |
| UIVersion | int, |
| CheckinComment | nvarchar(1023), |
| WelcomePageUrl | nvarchar(260), |
| WelcomePageParameters | nvarchar(max), |
| tp_Flags | bigint, |
| Acl | varbinary(max), |
| AnonymousPermMask | bigint, |
| DraftOwnerId | int, |
| Level | tinyint, |
| ParentVersion | int, |
| TransformerId | uniqueidentifier, |
| ParentLeafName | nvarchar(128), |
| ProgId | nvarchar(255), |
| DoclibRowId | int, |
| tp_DefaultWorkflowId | uniqueidentifier, |
| ListId | uniqueidentifier, |
| ItemChildCount | int, |
| FolderChildCount | int, |
| MetaInfoVersion | int, |
| {CurVerMetaInfo} | varbinary(max), |
| ContentVersion | int, |
| IsDirty | bit, |
| {NextBSN} | bigint, |
| {StreamSchema} | tinyint, |
| {InternalVersion} | int |

Id: The **Document Identifier** (section [2.2.1.1.2](#)) of this contained document.

{FullUrl}: The URL in store-relative form for this document.

Type: The **Document Store Type** of the document.

MetaInfoTimeLastModified: A datetime with a timestamp in UTC format specifying the last time the **MetaInfo** column value of the document was changed. This value can be NULL if the **MetaInfo** column value of the document has never been changed.

MetaInfo: A metadict for the document. The metadict format is specified in [\[MS-FPSE\]](#) section 2.2.2.2.11. This value can be NULL, and MUST be NULL if the **MetaInfoTimeLastModified** value is not more recent than the *@ClientTimeStamp* parameter.

Size: The number of bytes in the document stream of the document. This value MUST be NULL if the document does not have a document stream.

TimeCreated: A datetime with a timestamp in UTC format specifying when the document was created.

TimeLastModified: A datetime with a timestamp in UTC format specifying when the document was last modified.

ETagVersion: A counter used for internal conflict detection that is incremented any time a change is made to the document.

DocFlags: A **Doc Flags** value (section [2.2.2.3](#)) describing the document. This value can be NULL if the document does not have any **Doc Flags** associated with it.

{ListType}: A packed combination of the **List Base Type** (section [2.2.1.2.11](#)) and **List Server Template** (section [2.2.1.2.12](#)) values of the list (1) containing this document, consisting of the **List Server Template** value multiplied by 256 and added to the value of the **List Base Type**.

tp_Name: The **List Identifier** (section [2.2.1.1.5](#)) of the list (1) containing this document.

{ListTitle}: If the containing document is the root folder of the list (1) which contains this document, this contains the display name of the list (1). Otherwise, this value MUST be NULL.

CacheParseId: This value MUST be NULL.

{GhostDirName}: This value MUST be NULL.

{GhostLeafName}: This value MUST be NULL.

tp_Login: If this document is currently checked out, this is the login name of the user to whom it is checked out. In all other cases, this MUST be NULL.

CheckoutDate: A datetime with a timestamp in UTC format specifying when this document was checked out. This MUST be NULL if the document has never been checked out.

CheckoutExpires: A datetime with a timestamp in UTC format specifying when the short-term lock for this document will expire. If this date is in the past, this document SHOULD be treated as unlocked. This value can be NULL if no short-term lock has been placed on the document.

VirusStatus: A **Virus Status** value (section [2.2.1.2.17](#)) specifying the current virus state of the document. This value can be NULL if the document has not been processed by a virus scanner.

VirusInfo: A string containing a provider-specific message returned by the virus scanner when it last processed the document. This value can be NULL if the document has not been processed by a virus scanner.

SetupPathVersion: If this is an uncustomized document, this specifies the setup path location that the **SetupPath** fragment is relative to. This value MUST NOT be NULL. The following are valid values.

| Value | Description |
|-------|---|
| 2 | The SetupPath is relative to the install location of WSS2 on the front-end Web server (for example, Program Files\Common Files\Microsoft Shared\Web Server Extensions\60). |
| 3 | The SetupPath is relative to the install location of WSS3 on the front-end Web server (for example, Program Files\Common Files\Microsoft Shared\Web Server Extensions\12). |
| 4 | The SetupPath is relative to the install location of WSS4 on the front-end Web server (for example, Program Files\Common Files\Microsoft Shared\Web Server Extensions\14). |
| 15 | The SetupPath is relative to the install location of Microsoft SharePoint Foundation 2013 on the front-end Web server (for example, Program Files\Common Files\Microsoft Shared\Web Server Extensions\15). |

SetupPath: If the document is now or once was uncustomized, this contains the setup path fragment relative to the base setup path described above by the **SetupPathVersion** value, where the document stream of the document can be found. This value can be NULL.

SetupPathUser: If the document is now or once was uncustomized, this contains the login name of the user who created the uncustomized document. This value can be NULL.

NextToLastTimeModified: The value of **TimeLastModified** from the previous time when the document was last saved. If the **NextToLastTimeModified** value matches the **TimeLastModified** value when the change occurred and the client has a version of the document that it has successfully modified, the client can safely submit the document to the front-end Web server despite what appears to be an intervening edit to the document. This value MUST be NULL if the document has never been saved.

UIVersion: The UI version number for the document.

CheckinComment: An optional user-supplied description provided when the document is checked in or published. This value can be NULL.

WelcomePageUrl: If the document is a folder, this specifies an optional page to redirect to when the folder is requested with an HTTP GET operation. The URL is relative to the URL of the folder itself, and MUST be contained within that folder. Attempts to break out of the folder, such as ".././somepage.aspx", are not valid. This value can be NULL.

WelcomePageParameters: Contains optional URL parameters to specify as part of the **WelcomePageUrl** value. These parameters start at either the query string signifier '?' or the bookmark signifier '#'. This value can be NULL.

tp_Flags: The **List Flags** value (section [2.2.2.5](#)) for the list (1) that contains the document.

Acl: The binary serialization of the **WSS ACL Format** (section [2.2.3.6](#)) for the document. The **WSS ACL** is either explicitly defined for the document or inherited from the parent object of the document. This value can be NULL if a **WSS ACL** is not defined for the document.

AnonymousPermMask: A **WSS Rights Mask** (section [2.2.2.15](#)) that indicates the permissions granted anonymous users or those users that have no specific permissions to the document. This value can be NULL if anonymous access to the document is not allowed.

DraftOwnerId: The **User Identifier** (section [2.2.1.1.13](#)) of the user that published the document as a draft. This value MUST be NULL if the document is not a draft version.

Level: A **Publishing Level Type** value (section [2.2.2.6](#)) specifying the publishing status of the document.

ParentVersion: If the document is a transformed version of another document, this is the UI version value from the original document. This value **MUST** be NULL if the document is not the product of a document transformation.

TransformerId: If the document is a transformed version of another document, this is the GUID of the agent that performed the transformation. This value **MUST** be NULL if the document is not the product of a document transformation.

ParentLeafName: If the document is a transformed version of another document, this is the leaf name of the original document. The original document **MUST** be in the same folder as the transformed document. If either is moved, the relationship is broken. This value **MUST** be NULL if the document is not the product of a document transformation.

ProgId: Specifies a preferred application to open the document. The **ProgId** value is used to distinguish between different applications that save files with a given file extension (for example, different editors for .HTML or .XML files). This value **MUST** be NULL if a **ProgId** was not specified when the document was saved.

DoclibRowId: The identifier for a row in a document library for the document. If the document is not contained in a list (1), this value **MUST** be NULL.

tp_DefaultWorkflowId: The **Workflow Identifier** (section [2.2.1.1.16](#)) corresponding to the workflow (2) to be invoked if the document is in a moderated list (1) and the document is submitted for approval as part of a check in.

ListId: The **List Identifier** (section [2.2.1.1.5](#)) of the list (1) that contains the document. If the document is not contained in a list (1), this value **MUST** be NULL.

ItemChildCount: The number of list items for the list (1) that contains the document if the document is contained in a list (1).

FolderChildCount: The number of folders that exist in the list (1) that contains the document if the document is contained in a list (1).

MetaInfoVersion: A counter used for internal conflict detection that is incremented any time a change is made to the **MetaInfo** for this document.

{CurVerMetaInfo}: The value **MUST** be NULL.

ContentVersion: The version number of the document stream being returned.

IsDirty: A bit that specifies this document **MUST** have implementation-specific processing performed before its stream (1) can be returned. If this document does not require processing, this value **MUST** be zero.

{NextBSN}: The current BLOB sequence number of the document being returned.

{StreamSchema}: The current stream schema of the document being returned.

{InternalVersion}: The internal version number of the document being returned.

3.1.5.48 **proc_RenameUrl**

The **proc_RenameUrl** stored procedure renames a document or folder within a specified site.

```

PROCEDURE proc_RenameUrl (
    @SiteId                uniqueidentifier,
    @SubWebId              uniqueidentifier,
    @OldUrl                nvarchar (260),
    @NewUrl                nvarchar (260),
    @UserId                int,
    @AppPrincipalId        int,
    @ThresholdRowCount     int,
    @NewDoclibRowIdInput  int,
    @MaxNewRowsInput       int,
    @RenameFlags            int                = 0,
    @PutFlags               int                = 0,
    @ReturnFlags            int                = 0,
    @AttachmentOpOldUrl    int                = 3,
    @AttachmentOpNewUrl    int                = 3,
    @OldItemId              int                = NULL OUTPUT,
    @ParseDocsNow           tinyint           = NULL OUTPUT,
    @FailedUrl              nvarchar (260)    = NULL OUTPUT,
    @RequestGuid            uniqueidentifier  = NULL OUTPUT
);

```

@SiteId: The site collection identifier (section [2.2.1.1.9](#)) of the site collection containing the document or folder.

@SubWebId: The site identifier of the site containing the document or folder.

@OldUrl: The store-relative URL of the document or folder to be moved.

@NewUrl: The target store-relative URL of the document or folder after the move.

@UserId: The user identifier of the user who is requesting the move.

@AppPrincipalId: The app principal identifier of the app (1) that is requesting the operation. If the operation was not requested by an app (1) then it MUST be 0.

@ThresholdRowCount: If the **@OldUrl** parameter is a folder and this parameter is greater than 0 and the sum total of documents and folders contained within the **@OldUrl** parameter exceeds this parameter's value, then this stored procedure MUST NOT complete successfully.

@NewDoclibRowIdInput: The next available row number in the new list where this item is being copied.

@MaxNewRowsInput: The number of items that are being renamed as part of this rename operation.

@RenameFlags: A bit field determining document rename options. This can have one or more flags set. The only valid values of the **@RenameFlags** bits are specified in **Rename Flags** (section [2.2.2.8](#)).

@PutFlags: A bit field determining document change options. This can have one or more flags set. The only valid values of the **@PutFlags** bits are specified in **Put Flags Type** (section [2.2.2.7](#)).

@ReturnFlags: A bit field determining the type of information requested. This can have one or more flags set. The only valid bit values of **@ReturnFlags** are specified as follows.

| Value | Description |
|-------|--|
| 0x01 | Return information about the moved documents. |
| 0x02 | Return information about backward links referencing the moved documents. |

@AttachmentOpOldUrl: An **Attachments Flag** (section [2.2.1.2.1](#)) value for the document URL.

@AttachmentOpNewUrl: An **Attachments Flag** value for the destination URL.

@OldItemId: If this parameter is supplied, it will be set to the row number that was being used by the previous document (the URL specified by the *@OldUrl* parameter). If the *@OldUrl* parameter is a folder, then this parameter MUST be ignored.

@ParseDocsNow: An output parameter set to 1 to indicate that the moved document or documents in the folder MUST be parsed again. Reparsing is necessary when the document properties need to be scanned, for example, when the document is moved across lists, or when the document's file extension is modified. If this output parameter is supplied, then it will be set to 0 indicating that the document or documents in the folder MUST NOT be parsed again.

@FailedUrl: An output parameter indicating the URL at which the move operation failed. MUST be set to NULL if the move was successful.

@RequestGuid: The optional request identifier for the current request.

Return Values: The **proc_RenameUrl** stored procedure returns an integer return code which MUST be listed in the following table.

| Value | Description |
|----------|---|
| 0 | Successful execution. |
| 2 | File not found: Parent of target URL not found. |
| 3 | Path not found: Item not found at specified URL, site collection and site. |
| 5 | Access denied: The User specified in <i>@UserId</i> lacks the necessary privileges. |
| 15 or 51 | Cannot move to, or from, a forms folder in a list or document library. |
| 33 | Cannot move a folder which contains checked out documents. |
| 34 | Cannot rename a folder within a List or move a folder out of a list when the list is not a document library. |
| 36 | The rename operation failed to complete successfully because the value specified for the <i>@ThresholdRowCount</i> parameter exceeds the sum total of documents and folders contained within the URL specified by the <i>@OldUrl</i> parameter. |
| 50 | The document is a site, but <i>@RenameFlags</i> does not indicate that a Site move is requested. |
| 80 | Target URL is a document with a Document Store Type (section 2.2.2.4) of 0 (File), but <i>@PutFlags</i> value does not indicate a request to overwrite it. |
| 87 | Bad parameter: Unspecified Error prevented the requested move. |
| 130 | Cannot move to, or from, an image or a thumbnail file in an Image Library. |

| Value | Description |
|-------|--|
| 138 | Cannot move folder across lists. |
| 144 | Not an overwrite request and URL is a directory or site, or other invalid combination. |
| 161 | Cannot move folder across sites. |
| 190 | Cannot move folder containing thicket. |
| 206 | Target URL is too long. |
| 214 | Cannot move thicket. |
| 1150 | Concurrency violation. |
| 1358 | Internal database corruption. |
| 1359 | Unknown internal error. |
| 8398 | There was an error moving a list. At least one list could not be deleted. |

This stored procedure MUST return either zero, one or two result sets, depending on the values for input parameters as described for each result set.

3.1.5.48.1 Rename Result Set

The **Rename Result Set** returns basic information about the old and new URLs for all moved (renamed) Documents. When renaming a container object, affected items in the container are included in the **Rename Result Set**. The **Rename Result Set** MUST be returned only when requested (when bit 0x01 is set in *@ReturnFlags*). If the **Rename Result Set** is returned, it MUST return one row for each document which was renamed during the operation.

```

{OldUrlDirName}          nvarchar(256),
{OldUrlLeafName}        nvarchar(128),
{NewUrlDirName}         nvarchar(256),
{NewUrlLeafName}       nvarchar(128),
{Type}                  int;

```

{OldUrlDirName}: The directory name of the document before rename.

{OldUrlLeafName}: The leaf name of the document before rename.

{NewUrlDirName}: The directory name of the document after rename.

{NewUrlLeafName}: The leaf name of the document after rename.

{Type}: The Document Store Type (section [2.2.2.4](#)) of the renamed document.

3.1.5.48.2 Backward Link Result Set

The **Backward Link Result Set** returns the URL of each document containing a backward link to the moved (renamed) document(s). The **Backward Link Result Set** MUST be returned only when requested (bit 0x2 is set in *@ReturnFlags* and bit 0x4 is set in *@RenameFlags*.) If the **Backward Link Result Set** is returned, it MUST return one row for each item containing a backward link to any of the renamed document(s).

DocUrl nvarchar(260),

DocUrl: The store-relative form URL to the document holding the backward link to the renamed document.

3.1.5.49 proc_SecAddPrincipalToRole

The **proc_SecAddPrincipalToRole** stored procedure is invoked to add a security principal to a role defined within a site collection.

```
PROCEDURE proc_SecAddPrincipalToRole(  
    @SiteId                uniqueidentifier,  
    @WebId                 uniqueidentifier,  
    @ScopeId              uniqueidentifier,  
    @RoleId                int,  
    @UserId               int,  
    @AddChangeLog         bit = 0,  
    @ReturnAuditMask      bit = 1,  
    @AddToCurrentScopeOnly bit = 0,  
    @RequestGuid          uniqueidentifier = NULL OUTPUT  
);
```

@SiteId: The site collection identifier of the site collection containing the role and security principal.

@WebId: The site identifier of the site containing the role and security principal.

@ScopeId: The scope identifier of the security scope containing the role.

@RoleId: Specifies the role identifier of the **role definition** that the security principal is added into. **@RoleId** MUST correspond to a valid role.

@UserId: The user identifier for the security principal to be added to the specified role. This value MUST refer to an existing user identifier for the specified site collection.

@AddChangeLog: A bit flag specifying whether to update the **change log**. A value of 1 indicates that the change log MUST be updated. The default value of 0 indicates that the change log MUST NOT be updated.

@ReturnAuditMask: A bit flag specifying whether to return **Audit Flags** (section 2.2.2.1) data for the specified site. The default value of 1 indicates that **Audit Flags** data MUST be returned. A value of 0 indicates that **Audit Flags** data MUST NOT be returned.

@AddToCurrentScopeOnly: A bit flag specifying whether the principal will be added only to the given security scope. The default value of 0 indicates that security principal MUST be added to all security scopes up to the security scope of web indicated by **@WebId**. A value of 1 indicates that security principal MUST be added only to the security scope indicated by **@ScopeId**.

@RequestGuid: The optional request identifier for the current request.

Return Values: The **proc_SecAddPrincipalToRole** stored procedure returns an integer return code which MUST be in the following table.

| Value | Description |
|-------|-----------------------|
| 0 | Successful execution. |

| Value | Description |
|-------|--|
| 3 | The site specified by <i>@WebId</i> is not valid for membership permissions or there are no roles defined for this site. |

The **proc_SecAddPrincipalToRole** stored procedure MUST return one result set if the *@ReturnAuditMask* value is set to 1, and MUST NOT return a result set if the value is set to 0.

3.1.5.49.1 Site Audit Mask Result Set

The **Site Audit Mask Result Set** contains information about the **Audit Flags** (section [2.2.2.1](#)) set for the site. The **Site Audit Mask Result Set** MUST be returned if the *@ReturnAuditMask* value is set to 1. The **Site Audit Mask Result Set** is defined in the Common Result Sets **Site Audit Mask Result Set** (section [2.2.4.22](#)).

3.1.5.50 proc_SecAddRoleDef

The **proc_SecAddRoleDef** stored procedure creates a new role definition for a specified site within a site collection.

```

PROCEDURE proc_SecAddRoleDef(
    @SiteId                uniqueidentifier,
    @WebId                 uniqueidentifier,
    @Title                 nvarchar(255),
    @Description           nvarchar(512),
    @Hidden                bit,
    @RoleOrder             int,
    @Type                  tinyint,
    @PermMask              tPermMask,
    @IdToCreate            int,
    @RoleDefId             int = NULL OUTPUT,
    @RequestGuid           uniqueidentifier = NULL OUTPUT
);

```

@SiteId: The site collection identifier of the site collection to add the role definition to.

@WebId: The site identifier of the site to add the role definition to. The site MUST have its own scope specifying unique permissions.

@Title: The title of the role definition for display in the front-end Web server. This MUST be a value which does not match an existing role definition title within the site, and MUST NOT be NULL or an empty string.

@Description: The description of the role definition for display in the front-end Web server.

@Hidden: A bit flag specifying whether or not the role definition is to be displayed by the front-end Web server. This value MUST NOT be NULL. If this parameter is set to 1, then the front-end Web server MUST NOT display the role definition.

@RoleOrder: An integer value specifying the relative position in which this role definition is to be displayed in the front-end Web server. Multiple role definitions can have the same *@RoleOrder* value. This value MUST NOT be NULL.

@Type: The role definition type value for the role definition to be added.

@PermMask: A **WSS Rights Mask** (section [2.2.2.15](#)) specifying the rights to grant to the role definition. The **WSS Rights Mask** associated with the role definition **MUST** be set to this value.

@IdToCreate: The role identifier to assign to the new role definition. If this parameter is NULL, a new value **MUST** be assigned and returned in **@RoleDefId**. This parameter **MUST NOT** be a role identifier which already exists within the site collection.

@RoleDefId: The role identifier of the created role definition, returned as an output parameter.

@RequestGuid: The optional request identifier for the current request.

Return Values: The **proc_SecAddRoleDef** stored procedure returns an integer return code which **MUST** be listed in the following table.

| Value | Description |
|-------|---|
| 0 | Successful execution. |
| 80 | The @IdToCreate or @Title already exists or is NULL for a role definition within the site collection. |
| 1816 | The limit for the maximum number of role definitions in the specified site has been reached. |

Upon successful execution, the **proc_SecAddRoleDef** stored procedure **MUST** return a single result set.

3.1.5.50.1 Site Audit Mask Result Set

The **Site Audit Mask Result Set** contains information about the **Audit Flags** (section [2.2.2.1](#)) associated with the site. The **Site Audit Mask Result Set** **MUST** be returned on successful completion and **MUST** contain one row. The **Site Audit Mask Result Set** is defined in the Common Result Sets **Site Audit Mask Result Set** (section [2.2.4.22](#)).

3.1.5.51 proc_SecAddUser

The **proc_SecAddUser** stored procedure is invoked to add a new entry for a security principal to the UserInfo Table (section [2.2.6.10](#)) that contains descriptive properties and security information about security principals, and is stored in the back-end database server.

```

PROCEDURE proc_SecAddUser(
    @SiteId                uniqueidentifier,
    @SystemId              varbinary(512),
    @ExternalToken         varbinary(max),
    @ExternalTokenTime     datetime,
    @IsDomainGroup         bit,
    @IsActive              bit,
    @AccountType           int,
    @Login                 nvarchar(255),
    @Title                 nvarchar(255),
    @Email                 nvarchar(255),
    @Notes                 nvarchar(1023),
    @MobilePhone           nvarchar(127),
    @Flags                 int,
    @MembershipWebId       uniqueidentifier = NULL,
    @IncrementUserCount    bit = 0,
    @ImportDeleted         bit = 0,
    @AddedToTable         bit OUTPUT,
    @UserIdOut             int OUTPUT,

```



```

@LoginOut          nvarchar(255) OUTPUT,
@TitleOut          nvarchar(255) OUTPUT,
@emailOut          nvarchar(255) OUTPUT,
@NotesOut          nvarchar(1023) OUTPUT,
@MobilePhoneOut    nvarchar(127) OUTPUT,
@DeletedOut        bit OUTPUT,
@NeedtoAddToList   bit OUTPUT,
@RequestGuid       uniqueidentifier = NULL OUTPUT
);

```

@SiteId: The site collection identifier of the site collection to associate with the principal.

@SystemId: The **SystemID** of the principal to be added or updated. If a user exists with the specified **SystemID**, its record will be updated. Otherwise, a new user will be added with the specified **SystemID**.

@ExternalToken: An **External Group Token** (section [2.2.3.2](#)) specifying information on the principal's domain group membership, derived from an external security provider.

@ExternalTokenTime: A datetime in UTC format specifying the most recent time the **@ExternalToken** value was updated.

@IsDomainGroup: A bit flag specifying whether the principal to be added is a domain group. If this is set to 1, the principal being added is a domain group. If this is set to 0, then the principal is a user. This parameter MUST NOT be NULL.

@IsActive: A bit flag specifying if the principal is a user not marked as deleted in the site collection. When set to 1, the principal is a user not marked as deleted in the site collection. If this is set to 0, then the principal is a user marked as deleted in the site collection. This parameter MUST NOT be NULL.

@AccountType: The account type of user. If **@SystemId** isn't null or NULLSID (value is S-1-0-0, which represents a group (2) with no members), and **@AccountType** is 2, then the added user's User Identifier represents an app account identifier (1073741822). All other values will be ignored.

@Login: The login name of the principal to be added. This parameter MUST NOT be NULL.

@Title: The display name of the principal to be added. This parameter MUST NOT be NULL.

@Email: The email address of the principal to be added. This parameter MUST NOT be NULL.

@Notes: A string containing notes about the principal to be added. This parameter MUST NOT be NULL.

@MobilePhone: The mobile phone of the principal to be added.

@Flags: A **UserInfo Flags** (section [2.2.2.12](#)) specifying the principal's options.

@MembershipWebId: The site identifier of the site within the same site collection that the principal will be added as a member of.

@IncrementUserCount: A bit flag specifying whether to increment the user count of the site collection. When this parameter is set to 1, the user count in the site collection MUST be incremented.

@ImportDeleted: A bit flag specifying whether the principal is to be added as deleted. When this parameter is set to 1, the user information for the principal MUST be marked as deleted. The

deleted state is set within the UserInfo Table, rather than dropping entries from the UserInfo Table, to preserve list item ownership information.

@AddedToTable: An output parameter indicating that an entry for the principal has been added to the UserInfo Table. Its value MUST be listed in the following table.

| Value | Description |
|-------|--|
| 0 | The principal already exists in the UserInfo Table. |
| 1 | The user information for the principal has been added to the UserInfo Table. |

@UserIdOut: An output parameter which MUST contain the user identifier of the added principal on successful completion.

@LoginOut: An output parameter which MUST contain the login name of the added principal on successful completion.

@TitleOut: An output parameter which MUST contain the display name of the added principal on successful completion. It MUST be NULL otherwise.

@EmailOut: An output parameter which MUST contain the email address of the added principal on successful completion. It MUST be NULL otherwise.

@NotesOut: An output parameter which MUST contain the notes about the added principal on successful completion. It MUST be NULL otherwise.

@MobilePhoneOut: An output parameter which MUST contain the mobile phone of the added principal on successful completion. It MUST be NULL otherwise.

@DeletedOut: An output parameter which can indicate the deleted state of the principal. Its value MUST be listed in the following table.

| Value | Description |
|-------|--|
| 0 | The user information has not been marked as deleted. |
| 1 | The user information has been marked as deleted. |

@NeedtoAddtoList: An output parameter which can indicate if this user is already in the userinfo list.

| Value | Description |
|-------|--|
| 0 | The user is already in the UserInfo list, and does not need to be added again. |
| 1 | The user is not in the UserInfo list, it needs to be added to UserInfo list later. |

@RequestGuid: The optional request identifier for the current request.

Return Values: The **proc_SecAddUser** stored procedure returns an integer return code, which MUST be listed in the following table.

| Value | Description |
|-------|-----------------------|
| 0 | Successful execution. |

| Value | Description |
|-------|---|
| 80 | A principal with the same login name but a different SystemID already exists. |
| 212 | The site collection is locked against write operations occurring. |
| 1359 | An internal error has occurred. |
| 1816 | The maximum number of users that can be added to a site has been exceeded and no additional users can be added to the site. |

The **proc_SecAddUser** stored procedure MUST NOT return any result sets.

3.1.5.52 proc_SecAddUserToSiteGroup

The **proc_SecAddUserToSiteGroup** stored procedure is invoked to add a user to a permission level in the site collection. The user is added to the permission level and the root site of the site collection, the user's **User Token** and status as active user is updated, and the change is logged to the change log and site audit log.

```

PROCEDURE proc_SecAddUserToSiteGroup(
    @SiteId                uniqueidentifier,
    @GroupId                int,
    @UserIDToBeAdded       int,
    @UserID                 int,
    @AppPrincipalId        int,
    @SiteAdmin              bit,
    @BelongsToGroup        bit,
    @GroupOwnerId           int,
    @CurrentUserIsOwner    bit,
    @RequestGuid            uniqueidentifier = NULL OUTPUT
);

```

@SiteId: The site collection identifier (section [2.2.1.1.9](#)) for the site collection that contains the permission level specified by **@GroupId**.

@GroupId: A permission level identifier for the permission level that the user specified by **@UserIDToBeAdded** refers to. This value MUST refer to an existing permission level within the site collection specified by **@SiteId**.

@UserIDToBeAdded: A user identifier for the user being added to the permission level specified by **@GroupId**. This value MUST refer to an existing user identifier for the site collection specified by **@SiteId**.

@UserID: The user identifier for the user who is adding the user specified by **@UserIDToBeAdded** to the permission level specified by **@GroupId**. This value MUST refer to an existing user Identifier in the site collection specified by **@SiteId**.

@AppPrincipalId: The app principal identifier of the app (1) that is requesting the operation. If the operation was not requested by an app (1) then it MUST be set to 0.

@SiteAdmin: If this parameter is set to 1, the user specified by **@UserID** is a site collection administrator. If this parameter is set to 0, then the user specified by **@UserID** is not a site collection administrator.

@BelongsToGroup: If this parameter is set to 1, then the user specified by *@UserID* is a member of the permission level. If this parameter is set to 0, then the user specified by *@UserID* is not a member of the permission level.

@GroupOwnerId: The user identifier for the owner of the permission level specified by *@GroupId*. *@GroupOwnerId* MUST refer to an existing owner, which can be either a user or another permission level.

@CurrentUserIsOwner: If this parameter is set to 1, then the user specified by *@GroupOwnerId* is the owner of the permission level specified by *@GroupId*. If this parameter is set to 0, the user is not the owner.

@RequestGuid: The optional request identifier for the current request.

Return Values: The **proc_SecAddUserToSiteGroup** stored procedure returns an integer return code, which MUST be listed in the following table.

| Value | Description |
|-------|---|
| 0 | Successful execution or the user already belongs to the permission level. |
| 5 | The user specified by <i>@UserID</i> does not have rights to modify the membership of the permission level specified by <i>@GroupID</i> . |

The **proc_SecAddUserToSiteGroup** stored procedure MUST NOT return any result sets.

3.1.5.53 proc_SecAddWebMembership

The **proc_SecAddWebMembership** stored procedure is invoked to associate an existing user within a site collection to a site within the same site collection.

```

PROCEDURE proc_SecAddWebMembership(
    @SiteId                uniqueidentifier,
    @WebId                 uniqueidentifier,
    @UserId                int,
    @RequestGuid           uniqueidentifier = NULL OUTPUT
);

```

@SiteId: The site collection identifier of the site collection containing the requested site specified by *@WebId* and requested user identifier specified by *@UserId*.

@WebId: The site identifier of the site to add a new user to. This value MUST refer to an existing site identifier within the site collection specified by *@SiteId*.

@UserId: The user identifier for the user to be added to membership of the site. This value MUST refer to an existing user identifier within the site collection specified by *@SiteId*.

@RequestGuid: The optional request identifier for the current request.

Return Values: The **proc_SecAddWebMembership** stored procedure returns an integer return code, which MUST be listed in the following table.

| Value | Description |
|-------|-----------------------|
| 0 | Successful execution. |

| Value | Description |
|-------|---|
| 3 | The site specified by <i>@WebId</i> was not found, or the ancestor site with unique permissions that defines the scope for the site specified by <i>@WebId</i> was not found. |

The **proc_SecAddWebMembership** stored procedure MUST NOT return any result sets.

3.1.5.54 proc_SecChangeToInheritedList

The **proc_SecChangeToInheritedList** stored procedure is invoked to change the scope of the specified list to the specified site and remove any role assignments and permission settings specific to the list.

The permissions of any list items contained in the specified list which have unique permissions MUST NOT be changed.

```
PROCEDURE proc_SecChangeToInheritedList (
    @SiteId                uniqueidentifier,
    @WebId                 uniqueidentifier,
    @ListId                uniqueidentifier,
    @RequestGuid           uniqueidentifier = NULL OUTPUT
);
```

@SiteId: The site collection identifier of the site collection.

@WebId: The site identifier of the site containing the list specified by *@ListId*.

@ListId: The list identifier of the list.

@RequestGuid: The optional request identifier for the current request.

Return Values: This procedure returns an integer return code which MUST be 0, and MUST return one result set on successful completion. If this procedure encounters a failure, then no result set is returned.

3.1.5.54.1 Site Audit Mask Result Set

The **Site Audit Mask Result Set** contains information about the **Audit Flags** (section [2.2.2.1](#)) associated with the specified site. The **Site Audit Mask Result Set** MUST be returned on successful completion, and MUST return a single row. The **Site Audit Mask Result Set** is defined in the Common Result Sets **Site Audit Mask Result Set** (section [2.2.4.22](#)).

3.1.5.55 proc_SecChangeToInheritedWeb

The **proc_SecChangeToInheritedWeb** stored procedure changes a site from having its own unique permissions to instead use the permissions inherited from its nearest ancestor with unique permissions. When a site is changed to have inherited permissions, all role definitions and permissions for each list and document library are set to inherit from the security scope that the site uses.

```
PROCEDURE proc_SecChangeToInheritedWeb (
    @SiteId                uniqueidentifier,
    @WebId                 uniqueidentifier,
    @RequestGuid           uniqueidentifier = NULL OUTPUT
);
```

);

@SiteId: The site collection identifier for the site collection containing the site to be changed specified by **@WebId**.

@WebId: The site identifier for the site to change to use inherited permissions.

@RequestGuid: The optional request identifier for the current request.

Return Values: The **proc_SecChangeToInheritedWeb** stored procedure returns an integer return code that MUST be in the following table.

| Value | Description |
|-------|---|
| 0 | Successful execution. |
| 3 | The site was not found, the site does not have unique permissions, or an ancestor site with unique permissions was not found. |

The **proc_SecChangeToInheritedWeb** stored procedure MUST return two result sets on successful execution. If the stored procedure encounters a failure, then no result sets are returned.

3.1.5.55.1 Inherited Site Result Set

The **Inherited Site Result Set** returns the scope identifier and site identifier that the site specified by **@WebId** now inherits its permissions from. The **Inherited Site Result Set** MUST be returned on successful completion and MUST contain one row.

```
ScopeId                uniqueidentifier,  
{ParentWebPermAncestor} uniqueidentifier;
```

ScopeId: The scope identifier for the scope that the changed site specified by **@WebId** now inherits from.

{ParentWebPermAncestor}: The site identifier for an ancestor site that the changed site specified by **@WebId** now derives permissions from.

3.1.5.55.2 Site Audit Mask Result Set

The **Site Audit Mask Result Set** contains information about the **Audit Flags** (section [2.2.2.1](#)) associated with the site specified by **@WebId**. The **Site Audit Mask Result Set** MUST be returned on successful completion and MUST contain a single row.

The **Site Audit Mask Result Set** is defined in the Common Result Sets **Site Audit Mask Result Set** (section [2.2.4.22](#)).

3.1.5.56 proc_SecChangeToUniqueScope

The **proc_SecChangeToUniqueScope** stored procedure sets a securable object such as a site (2), list (1), or document library to use its own unique security scope, instead of inheriting its security scope from the first ancestor with uniquely permissions.

```
PROCEDURE proc_SecChangeToUniqueScope(  
    @SiteId                uniqueidentifier,
```

```

@WebId                uniqueidentifier,
@OldScopeId           uniqueidentifier,
@CopyFromScopeId     uniqueidentifier,
@Url                  nvarchar(260),
@DocId                uniqueidentifier,
@bIsWeb               bit,
@UserId               int,
@CopyAnonymousMask   bit,
@CopyRoleAssignments bit,
@ClearSubScopes       bit,
@bBreakBySiteOwner   bit,
@ReturnAuditMask      bit,
@MaxScopeInList       int,
@NewScopeId           uniqueidentifier = NULL OUTPUT,
@RequestGuid          uniqueidentifier = NULL OUTPUT
);

```

@SiteId: The site collection identifier of the site collection containing the securable object specified by **@Url** or **@DocId** to be set to use a unique security scope.

@WebId: The site identifier of the site (2) that is or contains the securable object.

@OldScopeId: The scope identifier for the original security scope of the securable object specified by **@Url** or **@DocId**.

@CopyFromScopeId: The scope identifier for a security scope to copy the administrator role, anonymous user permissions, and role assignments from for use as the new security scope. This parameter MUST NOT be NULL.

@Url: The store-relative form URL for the securable object. The securable object MUST be specified by the **@Url** or the **@DocId** parameter. The **@Url** parameter MUST be NULL to specify the securable object with the **@DocId** parameter.

@DocId: The document identifier (2) of the securable object. The **@DocId** parameter MUST be ignored and can be NULL if **@Url** specifies the securable object.

@bIsWeb: A bit flag specifying whether the securable object is a site. If this parameter is set to one, the securable object is a site (2), and all subsites which inherit their security scope from the site (2) specified by **@SiteId** MUST have their inheritances changed to the new security scope. This parameter MUST be set to zero if **@Url** does not point to a site (2), and this parameter MUST be set to one if **@Url** points to a site (2).

@UserId: Specifies the principal to be added to the new security scope in the administrator role, unless overridden by the **@bBreakBySiteOwner** parameter or the **@CopyFromScopeId** parameter.

@CopyAnonymousMask: A bit flag specifying whether to copy anonymous user permissions from the **@CopyFromScopeId** parameter into the new security scope. If this parameter is set to one, the permissions for anonymous user access MUST be copied from the **@CopyFromScopeId** parameter into the new security scope.

@CopyRoleAssignments: A bit flag specifying whether to copy the role assignments from the **@CopyFromScopeId** parameter into the new security scope. If this parameter is set to one, the role assignments MUST be copied from the **@CopyFromScopeId** parameter into the new security scope. If both **@bBreakBySiteOwner** and **@CopyRoleAssignments** are set to one, the setting of **@CopyRoleAssignments** will take precedence. The role assignments are copied from the security scope provided in **@CopyFromScopeId**.

@ClearSubScopes: A bit flag specifying whether to change every site (2), list (1) and document library under the URL to the new security scope or to change only inheriting ones to the new security scope. If this parameter is set to one, every site (2), list (1) and document library under the URL MUST be changed to the new security scope, including no inheriting ones.

@bBreakBySiteOwner: A bit flag specifying whether to use the site (2) owner in the administrator role instead of the principal specified by **@UserId**. If this parameter is set to one, the site (2) owner MUST be added to the administrator role in the new security scope definition. If both **@bBreakBySiteOwner** and **@CopyRoleAssignments** are set, the setting of **@CopyRoleAssignments** will take precedence. The role assignments are copied from the security scope provided in **@CopyFromScopeId**.

@ReturnAuditMask: A bit flag specifying whether to return a **Site Audit Mask Result Set** (section [3.1.5.56.1](#)). If this parameter is set to one, a **Site Audit Mask Result Set** MUST be returned on successful completion.

@MaxScopeInList: An integer value specifying the maximum number of unique security scopes under a list (1). If a list item's security scope is changed and the list (1) including this list item already has **@MaxScopeInList** unique security scopes, the stored procedure MUST return an error using the integer return code 1340.

@NewScopeId: The **Scope Identifier** (section [2.2.1.1.8](#)) generated for the new security scope, returned as an output parameter.

@RequestGuid: The optional request identifier for the current request.

Return Values: The **proc_SecChangeToUniqueScope** stored procedure returns an integer return code which MUST be listed in the following table.

| Value | Description |
|-------|---|
| 0 | Successful execution. |
| 3 | The specified securable object was not found at the specified location, the @OldScopeId does not match the scope identifier of the securable object, or the securable object has unique permissions. |
| 1340 | The security scope of a list item is changed and the list (1) including this list item already has @MaxScopeInList unique security scopes. |

If **@ReturnAuditMask** has a value of one, the **proc_SecChangeToUniqueScope** stored procedure MUST return a single result set on successful completion; otherwise, zero result sets MUST be returned.

3.1.5.56.1 Site Audit Mask Result Set

The **Site Audit Mask Result Set** contains information about the **Audit Flags** (section [2.2.2.1](#)) associated with the site. If **@ReturnAuditMask** has a value of 1, the **Site Audit Mask Result Set** MUST be returned on successful completion, and MUST contain only one row. The **Site Audit Mask Result Set** is defined in the Common Result Sets **Site Audit Mask Result Set** (section [2.2.4.22](#)).

3.1.5.57 proc_SecCheckDeletedAccounts

The **proc_SecCheckDeletedAccounts** stored procedure is invoked to check if a login name exists in the site collection.

```

PROCEDURE proc_SecCheckDeletedAccounts(
    @SiteId                uniqueidentifier,
    @Login                 nvarchar(255),
    @RequestGuid           uniqueidentifier = NULL OUTPUT
);

```

@SiteId: The site collection identifier for the site collection.

@Login: The login name of the principal as specified by the security provider (1) in use. This parameter MUST NOT be NULL.

@RequestGuid: The optional request identifier for the current request.

Return Values: The **proc_SecCheckDeletedAccounts** stored procedure returns an integer return code, which MUST be 0, and it MUST return a single result set.

3.1.5.57.1 Login Result Set

If a valid login name is found in the site collection, the **Login Result Set** MUST return one row containing the login name for each time **@Login** is found for the site collection specified by **@SiteId** within the **UserInfo Table** (section [2.2.6.10](#)); otherwise zero rows are returned.

```

tp_Login                nvarchar(255);

```

tp_Login: The login name for the user.

3.1.5.58 proc_SecCloneRoleDefinitions

The **proc_SecCloneRoleDefinitions** stored procedure creates a copy of the current role definition for a site. After successful execution, the site will have its own copy of the role definition and unique role assignments, and the site and all subsites that inherit permissions will use the new role definition.

```

PROCEDURE proc_SecCloneRoleDefinitions(
    @SiteId                uniqueidentifier,
    @WebId                 uniqueidentifier,
    @CopyRoleAssignments  bit,
    @UserId                int,
    @NewScopeId           uniqueidentifier OUTPUT,
    @RequestGuid           uniqueidentifier = NULL OUTPUT
);

```

@SiteId: The site collection identifier of the site collection containing the site.

@WebId: The site identifier of the site which will have its current role definition copied.

@CopyRoleAssignments: Specifies whether to keep the current role assignments. If this parameter is set to 1, the current role assignments will be kept. If this parameter is set to 0, then the user specified by **@UserId** will be added to the Administrator Role, and everyone else will be removed from all roles. **@CopyRoleAssignments** MUST NOT be NULL.

@UserId: The user identifier of the current user. **@UserId** is assigned to the administrator role when **@CopyRoleAssignments** is set to 0. This value MUST refer to an existing user identifier for the specified site collection.

@NewScopeId: An output parameter which contains a scope identifier for the security scope of the site. If the site already has unique role assignments before this call, then a new security scope MUST NOT be generated, and the output parameter MUST be the original scope identifier of the site. If the site does not have unique role assignments before this call, then a new security scope MUST be generated for this site, and the scope identifier of the new security scope MUST be returned in the output parameter.

@RequestGuid: The optional request identifier for the current request.

Return Values: The **proc_SecCloneRoleDefinitions** stored procedure returns an integer return code, which MUST be listed in the following table.

| Value | Description |
|-------|---|
| 0 | Successful execution. |
| 3 | The site was not found. Either the site specified by <i>@SiteId/@WebId</i> does not exist, or the site already has its own role definition. |
| 80 | The site has a role definition with the same title as one of the role definitions that will be cloned. |

The **proc_SecCloneRoleDefinitions** stored procedure MUST return either one or two result sets on successful execution, both of which used the same result set definition.

3.1.5.58.1 Site Audit Mask Result Set

The **Site Audit Mask Result Set** contains the information about the Audit Flags (section [2.2.2.1](#)) associated with the specified site. On successful execution, the **Site Audit Mask Result Set** MUST be returned only once if *@CopyRoleAssignments* is set to 1. If *@CopyRoleAssignments* is set to 0, then the **Site Audit Mask Result Set** MUST be returned twice on successful execution.

The **Site Audit Mask Result Set** MUST contain a single row. The **Site Audit Mask Result Set** is defined in Common Result Sets **Site Audit Mask Result Set** (section [2.2.4.22](#)).

3.1.5.59 proc_SecCreateSiteGroup

The **proc_SecCreateSiteGroup** stored procedure is invoked to add a new permission level to a site collection.

```

PROCEDURE proc_SecCreateSiteGroup(
    @SiteId                uniqueidentifier,
    @Title                 nvarchar(255),
    @Description           nvarchar(512),
    @OwnerID              int,
    @OwnerIsUser          bit,
    @AppPrincipalId       int,
    @FirstMemberId        int,
    @UseExisting          bit,
    @SelfOwner            bit,
    @Flags                int,
    @GroupID              int                OUTPUT,
    @RequestGuid          uniqueidentifier = NULL    OUTPUT
);

```

@SiteId: The site collection identifier (section [2.2.1.1.9](#)) of the site collection containing the new permission level to be created.

@Title: The title of the new permission level. This parameter MUST NOT be NULL.

@Description: A description of the new permission level.

@OwnerID: A user identifier or site group identifier for the new site group's owner.

@OwnerIsUser: A bit flag specifying whether the site group owner specified by **@OwnerId** is a user or a site group.

- When **@OwnerIsUser** is set to 1, the new site group owner is a user in the site collection.
- When **@OwnerIsUser** is set to 0, the owner is a site group.

@AppPrincipalId: The app principal identifier of the app (1) that is requesting the operation. If the operation was not requested by an app (1) then it MUST be set to 0.

@FirstMemberId: A user identifier for the first member of the new site group. This value MUST correspond to an existing user identifier or be NULL. If this value is NULL then the site group MUST be created with no members (1).

@UseExisting: A bit flag specifying whether to return the site group identifier of an existing site group with a title matching **@Title** or to create a new site group.

- When **@UseExisting** is set to 1, the procedure MUST return an existing site group with the same title as the **@Title** input parameter, and if such a site group is not found, then it MUST create a new site group.
- When **@UseExisting** is set to 0, the procedure MUST return a failure code value of 80 if an existing site group with a matching title is found, and if such a site group is not found, then it MUST create a new site group.

@SelfOwner: A bit flag specifying whether or not the site group is its own owner. When **@SelfOwner** is set to 1, the site group MUST be set as its own owner, and the values of **@OwnerId** and **@OwnerIsUser** MUST be ignored.

@Flags: Contains a set of flags specifying properties about the site group. This parameter MUST NOT be NULL and MUST be one of the values listed in the following table.

| Value | Description |
|------------|--|
| 0x00000000 | Allow anyone to view the membership of the site group. |
| 0x00000001 | Only allow members of the site group to view the membership. |
| 0x00000002 | Allow members of the site group to edit the membership of the site group. |
| 0x00000004 | Allow users to request membership in this site group, and allow users to request to leave the site group. All requests MUST be sent to the e-mail address specified by RequestEmail. |
| 0x00000008 | Automatically accept user requests to join or leave the site group. This bit MUST be set only when the bit 0x00000004 is also set. |
| 0x00000010 | The site group is hidden in the user interface. |

@GroupID: An output parameter holding the integer site group identifier for the newly created or existing site group. If the procedure fails, then the value of this parameter SHOULD be ignored.

@RequestGuid: The optional request identifier for the current request.

Return Values: The **proc_SecCreateSiteGroup** stored procedure returns an integer return code, which MUST be included in the following table.

| Value | Description |
|-------|---|
| 0 | Successful execution. |
| 80 | Failed to create the site group because a site group with an identical title exists in the site collection. |

The **proc_SecCreateSiteGroup** stored procedure MUST NOT return any result sets.

3.1.5.60 proc_SecDecCurrentUsersCount

The **proc_SecDecCurrentUsersCount** stored procedure is invoked to reduce by one the total number of users in the specified site collection when configured to use Active Directory account creation mode. **proc_SecDecCurrentUsersCount** does not delete or update any user information.

```
PROCEDURE proc_SecDecCurrentUsersCount (
    @SiteId                uniqueidentifier,
    @RequestGuid           uniqueidentifier = NULL    OUTPUT
);
```

@SiteID: The Site Collection Identifier of the site collection.

@RequestGuid: The optional request identifier for the current request.

Return Values: The **proc_SecDecCurrentUsersCount** stored procedure returns an integer return code, which MUST be 0.

The **proc_SecDecCurrentUsersCount** stored procedure MUST return no result sets.

3.1.5.61 proc_SecGetAccountStatus

The **proc_SecGetAccountStatus** stored procedure provides status information for a site collection's users, which are not marked as deleted, and match the specified login name or email address.

```
PROCEDURE proc_SecGetAccountStatus (
    @SiteId                uniqueidentifier,
    @Login                 nvarchar(255),
    @Email                 nvarchar(255),
    @RequestGuid           uniqueidentifier = NULL    OUTPUT
);
```

@SiteId: The Site Collection Identifier of the site collection containing the requested Users.

@Login: The login name of a User to be matched.

@Email: The email address of a User to be matched. If this parameter is an empty string, it is ignored.

@RequestGuid: The optional request identifier for the current request.

Return Values: The **proc_SecGetAccountStatus** stored procedure MUST return an integer return code of 0.

The **proc_SecGetAccountStatus** stored procedure MUST return one result set as follows.

3.1.5.61.1 Account Status Result Set

The **Account Status Result Set** returns account information for the non-deleted Users matching the specified login name or email address. This result set MUST be returned and MUST contain one row for each User which is not a domain group. The **Account Status Result Set** MUST contain no rows if no matching Users are found.

| | |
|-------------|-----------------|
| tp_Login | nvarchar(255), |
| tp_Email | nvarchar(255), |
| tp_SystemID | varbinary(512); |

tp_Login: The login name of the matching User.

tp_Email: The email address of the matching User.

tp_SystemID: The **SystemId** of the matching User.

3.1.5.62 proc_SecGetAclFromScope

The **proc_SecGetAclFromScope** stored procedure is invoked to obtain the Access Control List and the anonymous User permissions for a given scope.

```
PROCEDURE proc_SecGetAclFromScope (
    @SiteId                uniqueidentifier,
    @ScopeId               uniqueidentifier,
    @RequestGuid           uniqueidentifier = NULL    OUTPUT
);
```

@SiteId: The Site Collection Identifier for the site collection containing the scope.

@ScopeId: The Scope Identifier for the scope for which the Access Control List and anonymous User permissions are requested.

@RequestGuid: The optional request identifier for the current request.

Return Values: The **proc_SecGetAclFromScope** stored procedure returns an integer return code which MUST be 0.

The **proc_SecGetAclFromScope** stored procedure MUST return a single result set as defined as follows.

3.1.5.62.1 ACL and Permission Result Set

The **ACL and Permission Result Set** (section [2.2.4.1](#)) contains permission information for the specified scope. If either of the required input parameters is not valid, then the **ACL and Permission Result Set** MUST contain zero rows; otherwise, one row MUST be returned. The **ACL and Permission Result Set** is defined in Common Result Sets **ACL and Permission Result Set** section.

3.1.5.63 proc_SecGetAllAclsForSite

The **proc_SecGetAllAclsForSite** stored procedure is invoked to list all Scope Identifiers and their associated ACL and anonymous permission masks in a site collection.

```
PROCEDURE proc_SecGetAllAclsForSite(  
    @SiteId                uniqueidentifier,  
    @MaxCount              int,  
    @RowCount              int                out,  
    @RequestGuid           uniqueidentifier = NULL    OUTPUT  
);
```

@SiteId: The Site Collection Identifier of the site collection for which the information is requested.

@MaxCount: The maximum size, in rows, allowed in the result set. If the number of unique scopes within the site collection exceeds **@MaxCount**, the **Access Control List Result Set** will not be returned.

@RowCount: Output parameter indicating the number of unique scopes that exist in the site collection.

@RequestGuid: The optional request identifier for the current request.

Return Values: The **proc_SecGetAllAclsForSite** stored procedure MUST return an integer return code of 0.

If the total count of unique Access Control Lists in the site collection does not exceed the value of the input parameter **@MaxCount**, then the **proc_SecGetAllAclsForSite** stored procedure MUST return the **Access Control List Result Set**. Otherwise, 0 result sets MUST be returned.

3.1.5.63.1 Access Control List Result Set

The **Access Control List Result Set** returns one row for each unique scope and associated Access Control List defined in the site collection.

```
ScopeId                uniqueidentifier,  
Acl                    varbinary(max),  
AnonymousPermMask     bigint;
```

ScopeId: The Scope Identifier of the scope.

Acl: The Access Control List (ACL) associated with the scope.

AnonymousPermMask: The **WSS Rights Mask** for anonymous users for this scope.

3.1.5.64 proc_SecGetAllGroupsAndMembershipInfo

The **proc_SecGetAllGroupsAndMembershipInfo** stored procedure is invoked to return information about all site groups and site group members (1) within a site collection.

```
PROCEDURE proc_SecGetAllGroupsAndMembershipInfo(  
    @SiteId                uniqueidentifier,  
    @RequestGuid           uniqueidentifier = NULL    OUTPUT  
);
```

@SiteID: The Site Collection Identifier of the site collection to find all site groups in.

@RequestGuid: The optional request identifier for the current request.

Return Code Values: The **proc_SecGetAllGroupsAndMembershipInfo** stored procedure returns an integer which MUST be 0.

The **proc_SecGetAllGroupsAndMembershipInfo** stored procedure MUST return two result sets in the following order.

3.1.5.64.1 Groups Result Set

The **Groups Result Set** returns all site groups within the site collection, one row per site group, sorted by Site Group Identifier, in ascending order. The **Groups Result Set** MUST be empty if there is no site group on the site collection.

| | |
|-------------|----------------|
| ID | int, |
| Title | nvarchar(255), |
| Description | nvarchar(512), |
| Owner | int, |
| OwnerIsUser | bit; |

ID: The **Site Group Identifier** of the site group.

Title: The title of the site group.

Description: The description of the site group.

Owner: The **User Identifier** or **Site Group Identifier** of the owner of the site group.

OwnerIsUser: A bit value indicating whether the owner of the group is a User or a site group. If the owner is a User, this parameter's value MUST be 1, otherwise, its value MUST be 0.

3.1.5.64.2 Group Membership Result Set

The **Group Membership Result Set** returns information about site group members (1) who are not marked as deleted. A member (1) can be a User or a domain group. Every row represents one site group member (1). The first column is the **GroupId**, the **Site Group Identifier**, followed by columns about the site group member (1). The **Group Membership Result Set** is sorted by **GroupId**, in ascending order. If a member (1) belongs to more than one site group, then the member's (1) information will appear in multiple rows, with different **GroupIds**. The **Group Membership Result Set** MUST be empty if none of the site groups have any members (1).

| | |
|----------------|-----------------|
| GroupId | int, |
| tp_Id | int, |
| tp_SystemID | varbinary(512), |
| tp_Title | nvarchar(255), |
| tp_Login | nvarchar(255), |
| tp_Email | nvarchar(255), |
| tp_Notes | nvarchar(1023), |
| tp_SiteAdmin | bit, |
| tp_DomainGroup | bit, |
| tp_Flags | int; |

GroupId: The Site Group Identifier of the site group which contains this member (1).

tp_Id: The user identifier of the member (1) who belongs to the site group specified by the **GroupId** in the first column.

tp_SystemID: The SystemID of the member (1).

tp_Title: The display name of the member (1).

tp_Login: The login name of the member (1).

tp_Email: The email address of the member (1). This parameter can be empty, but it MUST NOT be NULL.

tp_Notes: A string which contains extra information about the member (1). It can be empty, but it MUST NOT be NULL.

tp_SiteAdmin: A bit value indicating whether the member (1) is a site collection Administrator. If the member (1) is a site collection Administrator, this parameter's value MUST be 1, otherwise, it MUST be 0.

tp_DomainGroup: A bit value indicating whether the member (1) is a domain group. If the site group member (1) is a domain group, this parameter's value MUST be 1. Otherwise, its value MUST be 0.

tp_Flags: A 4-byte integer bit mask determining the user's options. See [\[MS-WSSFO2\]](#) section 2.2.1.12.

3.1.5.65 **proc_SecGetApplicationPrincipalAndUserToken**

The **proc_SecGetApplicationPrincipalAndUserToken** stored procedure is invoked to return information about a principal based on the principal's login name and user identifier.

```
PROCEDURE proc_SecGetApplicationPrincipalAndUserToken (
    @SiteId                uniqueidentifier,
    @AppLogin              nvarchar(255),
    @UserId                int,
    @RequestGuid           uniqueidentifier = NULL OUTPUT
);
```

@SiteId: The Site Collection Identifier (section [2.2.1.1.9](#)) of the site collection containing the principal.

@AppLogin: The principal's login name.

@UserId: The user identifier of the principal.

@RequestGuid: The optional request identifier for the current request.

Return values: The **proc_SecGetApplicationPrincipalAndUserToken** stored procedure returns an integer return code, which MUST be 0.

If **@UserId** is NULL, then the **proc_SecGetApplicationPrincipalAndUserToken** stored procedure MUST return one result set. If **@UserId** is not NULL, the **proc_SecGetApplicationPrincipalAndUserToken** stored procedure MUST return two result sets in the order specified.

3.1.5.65.1 Application Principal Result Set

The **Application Principal Result Set** returns information on a principal specified by *@AppLogin*. The **proc_SecGetApplicationPrincipalAndUserToken** stored procedure MUST return the **Application Principal Result Set**.

If *@AppLogin* does not match a principal, the **Application Principal Result Set** MUST be returned with zero rows. Otherwise, the **Application Principal Result Set** MUST be returned with a single row of data for the principal.

| | |
|-------------|-----------------|
| tp_ID | int, |
| tp_IsActive | bit, |
| tp_Title | nvarchar(255), |
| tp_Email | nvarchar(255), |
| tp_Token | varbinary(max), |
| tp_Flags | int; |

tp_ID: The user identifier of the principal.

tp_IsActive: Set to "1" if the current user is an active user in the site collection.

tp_Title: The principal's display name.

tp_Email: The principal's e-mail address.

tp_Token: A **WSS User Token** (section [2.2.3.10](#)) value specifying the site group membership of the principal.

tp_Flags: Contains the user information flags value associated with this principal.

3.1.5.65.2 External Token Result Set

The **External Token Result Set** returns information on a principal specified by *@UserId*. If *@UserId* is NULL, then the **proc_SecGetApplicationPrincipalAndUserToken** stored procedure MUST not return the **External Token Result Set**. If *@UserId* does not match a principal, then the **External Token Result Set** MUST be returned with zero rows. Otherwise, the **External Token Result Set** MUST be returned with a single row of data for the principal.

| | |
|------------------|-----------------|
| tp_ExternalToken | varbinary(max); |
|------------------|-----------------|

tp_ExternalToken: An **External Group Token** (section [2.2.3.2](#)) value encoding information on external group membership derived from an external authentication role provider.

3.1.5.66 proc_SecGetCompleteWebRoleMemberList

The **proc_SecGetCompleteWebRoleMemberList** stored procedure is invoked to list all role assignments for all the principals with permissions on a specified Site.

```
PROCEDURE proc_SecGetCompleteWebRoleMemberList (
    @SiteId                uniqueidentifier,
    @WebId                 uniqueidentifier,
    @LatestSecurityVersion bigint            OUTPUT,
    @RequestGuid           uniqueidentifier = NULL    OUTPUT
);
```

@SiteId: Site Collection Identifier of the site collection containing the Site whose permission information is requested.

@WebId: Site Identifier of the Site whose permission information is requested.

@LatestSecurityVersion: The current security version value for the specified site collection.

@RequestGuid: The optional request identifier for the current request.

Return Values: The **proc_SecGetCompleteWebRoleMemberList** stored procedure returns an integer return code which MUST be 0.

The **proc_SecGetCompleteWebRoleMemberList** stored procedure MUST return one result set.

3.1.5.66.1 Role Member Result Set

The **Role Member Result Set** returns one row for each principal's role assignment for the specified Site. If the **@SiteId** or **@WebId** parameters are not valid, then zero rows MUST be returned.

| | |
|----------------|-----------------|
| RoleId | int, |
| tp_Id | int, |
| tp_SystemID | varbinary(512), |
| tp_DomainGroup | bit; |

RoleId: The Role Identifier of the role for the role assignment.

tp_Id: The site group identifier or user identifier of the principal.

tp_SystemID: The **SystemId** of the principal

tp_DomainGroup: Set to 1 if the principal is a domain group; otherwise, 0.

3.1.5.67 proc_SecGetCurrentUsersCount

The **proc_SecGetCurrentUsersCount** stored procedure returns a result set containing a count of Users in the specified site collection.

```
PROCEDURE proc_SecGetCurrentUsersCount (
    @SiteId                uniqueidentifier,
    @RequestGuid           uniqueidentifier = NULL    OUTPUT
);
```

@SiteId: The Site Collection Identifier of the site collection.

@RequestGuid: The optional request identifier for the current request.

Return Values: The **proc_SecGetCurrentUsersCount** stored procedure MUST return an integer return code of 0.

The **proc_SecGetCurrentUsersCount** stored procedure MUST return a single result set for the specified site collection as follows.

3.1.5.67.1 User Count Result Set

The **User Count Result Set** returns the number of Users registered with this site collection when configured in Active Directory account creation mode. When not in Active Directory account creation mode, **UsersCount** will be 1. The **User Count Result Set** MUST return one row for a given valid *@SiteId*, otherwise if *@SiteId* is invalid, zero rows MUST be returned.

```
UsersCount          int,  
UserQuota           int,  
{StorageQuotaError} int;
```

UsersCount: Contains the integer value for the number of Users registered with the specified site collection when configured in Active Directory account creation mode. In any other configuration, **UsersCount** MUST return 1.

UserQuota: Contains the limit for the number of Users allowed in the specified site collection. A value of 0 specifies no limit on the number of allowed Users.

{StorageQuotaError}: An error number generated when a site collection is over quota or locked. Its value MUST be listed in the following table.

| Value | Description |
|-------|--|
| 0 | Default value, no error. |
| 212 | The site collection is locked. |
| 1816 | Quota has been exceeded on this site collection. |

3.1.5.68 proc_SecGetDomainGroupMapData

The **proc_SecGetDomainGroupMapData** stored procedure is invoked to retrieve the domain group map cache information for a site collection.

```
PROCEDURE proc_SecGetDomainGroupMapData (  
    @SiteId          uniqueidentifier,  
    @DGCacheVersion bigint,  
    @RequestGuid     uniqueidentifier = NULL    OUTPUT  
);
```

@SiteId: The Site Collection Identifier.

@DGCacheVersion: The version number of the Domain Group Map Cache in the front-end Web server.

@RequestGuid: The optional request identifier for the current request.

Return Values: The **proc_SecGetDomainGroupMapData** stored procedure returns an integer return code which MUST be 0.

The **proc_SecGetDomainGroupMapData** stored procedure MUST return 1 or 2 of the following result sets.

3.1.5.68.1 Domain Group Cache Versions Result Set

The **Domain Group Cache Versions Result Set** MUST be returned and MUST contain one row of version number data. If the specified *@DGCacheVersion* value is -2, then all columns returned MUST have the value -2, indicating that the value MUST NOT be used for comparison.

The **Domain Group Cache Versions Result Set** is defined in the Common Result Sets **Domain Group Cache Versions Result Set** (section [2.2.4.4](#)).

3.1.5.68.2 Domain Group Cache BEDS Update Result Set

The **Domain Group Cache BEDS Update Result Set** MUST be returned if *@DGCacheVersion* does not equal "-2" and the value of **RealVersion** is greater than the value of **CachedVersion** in the results of the **Domain Group Cache Versions Result Set** (section [2.2.4.4](#)). Otherwise, the **Domain Group Cache BEDS Update Result Set** MUST NOT be returned.

If the **Domain Group Cache BEDS Update Result Set** is returned, then there MUST be one row in the **Domain Group Cache BEDS Update Result Set** for each domain group, which is a member of a site group in the site collection, ordered by the identifier of the domain groups. A row is also returned for every other domain group that does not have a **GroupId** tied to it, including domain groups with NULL GroupIds.

The **Domain Group Cache BEDS Update Result Set** is defined in the Common Result Sets **Domain Group Cache BEDS Update Result Set** (section [2.2.4.3](#)).

3.1.5.68.3 Domain Group Cache WFE Update Result Set

The **Domain Group Cache WFE Update Result Set** MUST be returned if *@DGCacheVersion* does not equal "-2" and the value of **RealVersion** is less than or equal to the value of **CachedVersion** in the results of the **Domain Group Cache Versions Result Set** (section [2.2.4.4](#)). Otherwise, the **Domain Group Cache WFE Update Result Set** MUST NOT be returned.

If the **Domain Group Cache WFE Update Result Set** is returned, then it MUST contain one row.

The **Domain Group Cache WFE Update Result Set** is defined in the Common Result Sets **Domain Group Cache WFE Update Result Set** (section [2.2.4.5](#)).

3.1.5.69 proc_SecGetGroupById

The **proc_SecGetGroupById** stored procedure is invoked to check whether the specified Group (either a site group or a domain group) exists in the specified site collection.

```
PROCEDURE proc_SecGetGroupById(
    @SiteId                uniqueidentifier,
    @GroupId               int,
    @Count                 int                OUTPUT,
    @RequestGuid           uniqueidentifier = NULL    OUTPUT
);
```

@SiteId: The **Site Collection Identifier** of the site collection to search for the Group.

@GroupId: The identifier (a **Site Group Identifier** for site groups, or a **User Identifier** for domain groups) of the specified Group.

@Count: Specifies whether the specified Group exists in the site collection as either a site group or a domain group. If the specified Group exists, **@Count** MUST be 1; otherwise, **@Count** MUST be 0.

@RequestGuid: The optional request identifier for the current request.

Return Code Values: The **proc_SecGetGroupById** stored procedure returns an integer which MUST be 0.

The **proc_SecGetGroupById** stored procedure MUST NOT return any result sets.

3.1.5.70 proc_SecGetGroupOwner

The **proc_SecGetGroupOwner** stored procedure is invoked to retrieve the User Identifier or Site Group Identifier for the owner of a site group. User Identifier and Group Identifier do not collide within the same site collection.

```
PROCEDURE proc_SecGetGroupOwner(  
    @SiteId                uniqueidentifier,  
    @GroupId               int,  
    @OwnerId               int OUTPUT,  
    @RequestGuid           uniqueidentifier = NULL    OUTPUT  
);
```

@SiteId: Site Collection Identifier for the site collection containing the site group.

@GroupId: The site group's identifier.

@OwnerId: An output parameter containing the User Identifier or Site Group Identifier of the site group owner, or "-1" if the specified site group does not exist.

@RequestGuid: The optional request identifier for the current request.

Return Values: The **proc_SecGetGroupOwner** stored procedure returns an integer return code which MUST be listed in the following table.

| Value | Description |
|-------|--------------------------------|
| 0 | Successful execution. |
| 1319 | The site group does not exist. |

The **proc_SecGetGroupOwner** stored procedure MUST NOT return a result set.

3.1.5.71 proc_SecGetGroupSecurityScopes

The **proc_SecGetGroupSecurityScopes** stored procedure is invoked to retrieve a site group's role assignments information on all security scopes within a given site collection.

```
PROCEDURE proc_SecGetGroupSecurityScopes(  
    @SiteId                uniqueidentifier,  
    @PrincipalId           int,  
    @RequestGuid           uniqueidentifier = NULL    OUTPUT,  
);
```

@SiteId: The Site Collection Identifier of the site collection containing the site group.

@PrincipalId: The site group identifier.

@RequestGuid: The optional request identifier for the current request.

Return Values: The **proc_SecGetGroupSecurityScopes** stored procedure MUST return an integer return code of 0.

The **proc_SecGetGroupSecurityScopes** stored procedure MUST return the following result set.

3.1.5.71.1 Security Scopes Result Set

The **Security Scopes Result Set** returns scope information for the specified security principal. The **Security Scopes Result Set** will be returned with zero or more rows.

| | |
|----------|----------------|
| ScopeUrl | nvarchar(260), |
| Title | nvarchar(255); |

ScopeUrl: The URL to the root of the Security Scope.

Title: The name of the role to which the site group is assigned on the Security Scope specified by **{ScopeUrl}**.

3.1.5.72 proc_SecGetIndividualUrlSecurityCheckEventReceivers

The **proc_SecGetIndividualUrlSecurityCheckEventReceivers** stored procedure is invoked to request security information and event receivers information about a document at a specified location. If the document does not exist, **proc_SecGetIndividualUrlSecurityCheckEventReceivers** provides security information about the specified location.

```
PROCEDURE proc_SecGetIndividualUrlSecurityCheckEventReceivers (
    @SiteId                uniqueidentifier,
    @WebId                 uniqueidentifier,
    @FullUrl               nvarchar(260),
    @DirName               nvarchar(256),
    @LeafName              nvarchar(128),
    @UserId                int,
    @AttachmentsFlag       tinyint,
    @bGetAttachmentWritePerm bit,
    @bGetListMetaData      bit                = 0,
    @bGetListScopes        bit                = 0,
    @Level                 tinyint            = NULL,
    @HasEventReceiver      bit                OUTPUT,
    @MinLevel              tinyint            OUTPUT,
    @RequestGuid           uniqueidentifier   = NULL OUTPUT
);
```

@SiteId: The site collection identifier of the site collection containing the document location.

@WebId: The site identifier of the site containing the document location.

@FullUrl: The store-relative form URL of the document location, used to find a containing list or document library if the document does not exist.

@DirName: The directory name of the document location.

@LeafName: The leaf name of the document location.

@UserId: The user identifier of the current user, used to check for access privileges.

@AttachmentsFlag: An **Attachments Flag** (section [2.2.1.2.1](#)) value specifying whether the document location is, or is contained within, an attachments folder.

@bGetAttachmentWritePerm: A bit flag specifying whether or not to return information about the write permissions of the current user to save an attachment at the specified document location. If this parameter is set to 1, and the *@AttachmentsFlag* parameter is not 0 or NULL, then the stored procedure MUST return the information about the current user's permissions as part of the **Individual URL Security Result Set** (section [3.1.5.72.1](#)). This parameter MUST be ignored if *@AttachmentsFlag* is 0 or NULL.

@bGetListMetaData: A bit flag specifying whether or not metadata for the list or document library containing the specified document is requested.

@bGetListScopes: A bit flag specifying whether or not security scope information is requested for the list or document library containing the document location.

@Level: If not set to NULL, then this parameter specifies the **Publishing Level Type** (section [2.2.2.6](#)) value to return in the **Individual URL Security Result Set**. If this parameter is NULL, the publishing level of the current version of the document for the current user MUST be used.

@HasEventReceiver: An output parameter that MUST be set to 1 if at least one event receiver is registered for the specified document; otherwise it is set to 0.

@MinLevel: A **Publishing Level Type** value that indicates the lowest value of publishing levels present for the document, returned as an output parameter.

@RequestGuid: The optional request identifier for the current request.

Return Values: The **proc_SecGetIndividualUrlSecurityCheckEventReceivers** stored procedure returns an integer return code which MUST be 0.

The **proc_SecGetIndividualUrlSecurityCheckEventReceivers** stored procedure MUST return between 1 and 5 result sets according to the input parameters. See result set descriptions for more details. The result sets are returned in the following listed order.

3.1.5.72.1 Individual URL Security Result Set

The **Individual URL Security Result Set** contains security information about the specified document. If the document does not exist, but the specified URL is within a list or document library, security information is returned for the specified document location.

The **Individual URL Security Result Set** MUST be returned if the specified document location is contained within a list or document library. Otherwise, the **NULL Individual URL Security Result Set** (section [3.1.5.72.2](#)) MUST be returned instead. If returned, the **Individual URL Security Result Set** MUST contain a single row.

The **Individual URL Security Result Set** is defined in the **Common Result Sets Individual URL Security Result Set** (section [2.2.4.12](#)).

3.1.5.72.2 NULL Individual URL Security Result Set

The **NULL Individual URL Security Result Set** indicates that the document location is not contained within a List or document library. The **NULL Individual URL Security Result Set** MUST

only be returned if the specified document location is not contained within a List or document library.

The **NULL Individual URL Security Result Set** is defined in the Common Result Sets **NULL Individual URL Security Result Set** (section [2.2.4.16](#)).

3.1.5.72.3 List Metadata Result Set

The **List Metadata Result Set** returns the metadata for the list or document library containing the specified document location. The **List Metadata Result Set** MUST only be returned if the `@bGetListMetadata` parameter is set to 1 and the document location is contained within a list or document library, otherwise, the **List Metadata Result Set** is not returned. If returned, then the **List Metadata Result Set** MUST contain a single row.

The **List Metadata Result Set** is defined in the Common Result Sets **List Metadata Result Set** (section [2.2.4.14](#)).

3.1.5.72.4 Event Receivers Result Set

The **Event Receivers Result Set** contains information about event receivers defined for the containing list or document library. This result set MUST only be returned if the `@bGetListMetaData` parameter is set to 1 and the document location is contained within a list or document library, otherwise, the **Event Receivers Result Set** is not returned. If returned, then the **Event Receivers Result Set** MUST contain one row for each event receiver registered for the list or document library.

The **Event Receivers Result Set** is defined in the Common Result Sets **Event Receivers Result Set** (section [2.2.4.11](#)).

3.1.5.72.5 List Scopes Result Set

The **List Scopes Result Set** returns the security information for the security scope associated with the document location. The **List Scopes Result Set** MUST only be returned if the `@bGetListScopes` parameter is set to 1 and the document location is within a list or document library, otherwise the **List Scopes Result Set** is not returned. If returned, then the **List Scopes Result Set** MUST contain one row.

| | |
|-------------------|-------------------|
| ScopeId | uniqueidentifier, |
| Acl | varbinary(max), |
| AnonymousPermMask | bigint; |

ScopeId: The scope identifier for the scope associated with the document location.

Acl: The ACL in **WSS ACL Format** (section [2.2.3.6](#)) of the scope associated with the document location.

AnonymousPermMask: The **WSS Rights Mask** (section [2.2.2.15](#)) that applies to an anonymous user, or a user with no assigned rights, in the scope associated with the document location.

3.1.5.73 proc_SecGetItemsWithUniquePermissions

The **proc_SecGetItemsWithUniquePermissions** stored procedure is invoked to return information about list items with unique permissions.

```
PROCEDURE proc_SecGetItemsWithUniquePermissions (
```



```

        @SiteId                uniqueidentifier,
        @WebId                 uniqueidentifier,
        @ListId                uniqueidentifier,
        @TitleMode             int,
        @MaxItemToReturn       int,
        @FolderOnly            bit,
        @RequestGuid           uniqueidentifier = NULL OUTPUT
    );

```

@SiteId: The Site Collection Identifier of the site collection containing the list items.

@WebId: The Site Identifier of the site containing the list items.

@ListId: The List Identifier of the list containing the list items.

@TitleMode: *@TitleMode* determines how title information is returned. If the list is a document library, then *@TitleMode* MUST be 0. If the list has a **List Base Type** (section [2.2.1.2.11](#)) of issues list, or a **List Server Template** (section [2.2.1.2.12](#)) of links list, then *@TitleMode* MUST be 1. Otherwise, *@TitleMode* MUST be 2.

@MaxItemToReturn: The maximum number of rows to be returned in the result set.

@FolderOnly: If this is not 0, then the result set MUST contain only information about folders. Otherwise, information about both folders and non-folders will be returned.

@RequestGuid: The optional request identifier for the current request.

Return values: The **proc_SecGetItemsWithUniquePermissions** stored procedure returns an integer return code, which MUST be 0.

This **proc_SecGetItemsWithUniquePermissions** stored procedure MUST return one result set.

3.1.5.73.1 Items with Unique Permissions Result Set

The **Items with Unique Permissions Result Set** returns one row for each list item with unique permissions.

```

        ScopeUrl                nvarchar(260),
        DoclibRowId             int,
        {Title}                  nvarchar(255),
        IsFolder                 bit;

```

ScopeUrl: The URL to the root of the security scope.

DoclibRowId: The row identifier for the document within the list.

{Title}: If *@TitleMode* is 0, then **{Title}** MUST be the leaf name of the document. If *@TitleMode* is 1, then **{Title}** MUST be the list item identifier. If *@TitleMode* is 2, then **{Title}** MUST contain the title of this list item.

IsFolder: If this list item is a folder, **IsFolder** MUST be 1. Otherwise, **IsFolder** MUST be 0.

3.1.5.74 proc_SecGetPrincipalByEmail

The **proc_SecGetPrincipalByEmail** stored procedure is invoked to return user information about a user associated with a specified email address.

```
PROCEDURE proc_SecGetPrincipalByEmail(  
    @SiteId                uniqueidentifier,  
    @Email                 nvarchar(255),  
    @RequestGuid           uniqueidentifier= NULL OUTPUT  
);
```

@SiteId: The site collection identifier for the site collection containing the user.

@Email: The user's email address. If this parameter is NULL, the email address MUST be the empty string.

@RequestGuid: The optional request identifier for the current request.

Return Values: The **proc_SecGetPrincipalByEmail** stored procedure returns an integer return code, which MUST be 0.

The **proc_SecGetPrincipalByEmail** stored procedure MUST return a single result set.

3.1.5.74.1 Principal User Information Result Set

The **Principal User Information Result Set** returns information about the User associated with the specified email address. The **Principal User Information Result Set** MUST contain zero rows if no users have the specified email address or if the associated user has been marked as deleted. The **Principal User Information Result Set** is defined in the Common Result Sets **Principal User Information Result Set** (section [2.2.4.19](#)).

3.1.5.75 proc_SecGetPrincipalById

The **proc_SecGetPrincipalById** stored procedure is invoked to return information about a principal or collection of principals based on a specified site group identifier or user identifier.

```
PROCEDURE proc_SecGetPrincipalById(  
    @SiteId                uniqueidentifier,  
    @PrincipalId           int,  
    @GetSTSToken           bit                = 0,  
    @GetExternalToken      bit                = 0,  
    @GetExpandedSTSGroup   bit                = 0,  
    @RequestGuid           uniqueidentifier = NULL OUTPUT  
);
```

@SiteId: The site collection identifier of the site collection containing the principal.

@PrincipalId: The site group identifier of the site group or user identifier of the principal to return information for.

@GetSTSToken: If this parameter is set to 1, then it indicates the **tp_token** value MUST be returned in both instances of the **Principal User Information Result Set**.

@GetExternalToken: If this parameter is set to 1, then it indicates the **tp_ExternalTokenLastUpdated** and **tp_ExternalToken** values MUST be returned in both instances of the **Principal User Information Result Set**.

@GetExpandedSTSGroup: If this parameter is set to 1, then it indicates a second **Principal User Information Result Set** MUST be returned when the first instance of the **Principal User Information Result Set** has zero rows. The second result set contains information about group membership for the site group represented by *@PrincipalId*. The rows returned in the second result set are all the members of that site group.

@RequestGuid: The optional request identifier for the current request.

Return Values: The **proc_SecGetPrincipalById** stored procedure returns an integer return code, which MUST be 0.

The **proc_SecGetPrincipalById** stored procedure MUST return one result set which can be returned either once or twice as described in the following.

3.1.5.75.1 User Information Result Set

The **User Information Result Set** returns information on a specified principal or the members of a site group.

If *@PrincipalId* matches a principal, the **User Information Result Set** MUST be returned once with a single row of data for the principal.

Otherwise, the **User Information Result Set** MUST be returned with zero rows, and if *@GetExpandedSTSGroup* is 1, another instance of the **User Information Result Set** MUST be returned, with one row of data for each principal within the site group.

| | |
|-------------------------------|-----------------|
| tp_ID | int, |
| tp_SystemID | varbinary(512), |
| tp_Title | nvarchar(255), |
| tp_Login | nvarchar(255), |
| tp_Email | nvarchar(255), |
| tp_Notes | nvarchar(1023), |
| tp_SiteAdmin | bit, |
| tp_DomainGroup | bit, |
| tp_Flags | int, |
| {tp_ExternalTokenLastUpdated} | datetime, |
| {tp_ExternalToken} | varbinary(max), |
| {tp_Token} | varbinary(max); |

tp_ID: The user identifier of the principal.

tp_SystemID: The principal's **SystemId** (section [2.2.1.1.12](#)).

tp_Title: The principal's display name.

tp_Login: The principal's login name.

tp_Email: The principal's e-mail address.

tp_Notes: A longer descriptive text associated with the principal.

tp_SiteAdmin: Set to 1 if the principal is a site collection administrator; otherwise, 0.

tp_DomainGroup: Set to 1 if the principal is a domain group; otherwise, 0.

tp_Flags: Contains the user information flags value describing this principal.

{tp_ExternalTokenLastUpdated}: A **timestamp** in UTC format specifying the time when the **External Group Token** (section [2.2.3.2](#)) was last updated. This parameter MUST be NULL if *@GetExternalToken* is 0.

{tp_ExternalToken}: An **External Group Token** value specifying the domain group membership of the principal. This parameter MUST be NULL if *@GetExternalToken* is 0.

{tp_Token}: A **WSS User Token** (section [2.2.3.10](#)) value specifying the site group membership of the principal. This parameter MUST be NULL if *@GetSTSToken* is 0.

3.1.5.76 **proc_SecGetPrincipalByIdEx**

The **proc_SecGetPrincipalByIdEx** stored procedure is invoked to return information about a principal based on a specified user identifier or a collection of principals based on a specified site group identifier. The **proc_SecGetPrincipalByIdEx** stored procedure is similar to the **proc_SecGetPrincipalById** stored procedure, except that the **proc_SecGetPrincipalByIdEx** stored procedure also returns the principal's mobile phone information.

```
PROCEDURE proc_SecGetPrincipalByIdEx (  
    @SiteId                uniqueidentifier,  
    @PrincipalId           int,  
    @GetSTSToken           bit                = 0,  
    @GetExternalToken     bit                = 0,  
    @GetExpandedSTSGroup  bit                = 0,  
    @RequestGuid          uniqueidentifier   = NULL OUTPUT  
);
```

@SiteId: The Site Collection Identifier of the site collection containing the principal(s).

@PrincipalId: The site group identifier of the site group or user identifier of the principal(s) to return information for.

@GetSTSToken: If this parameter is set to 1, it indicates the **tp_token** value MUST be returned in both instances of the **Principal User Information Result Set**.

@GetExternalToken: If this parameter is set to 1, it indicates the **tp_ExternalTokenLastUpdated** and **tp_ExternalToken** values MUST be returned in both instances of the **Principal User Information Result Set**.

@GetExpandedSTSGroup: If this parameter is set to 1, it indicates a second **Principal User Information Result Set** MUST be returned when the first instance of the **Principal User Information Result Set** has zero rows. The second result set contains information about group membership for the site group represented by *@PrincipalId*. The rows returned in the second result set are all the members of that site group.

@RequestGuid: The optional request identifier for the current request.

Return Values: The **proc_SecGetPrincipalById** stored procedure returns an integer return code, which MUST be 0.

The **proc_SecGetPrincipalByIdEx** stored procedure MUST return one result set which can be returned either once or twice as described in the following.

3.1.5.76.1 Extended Principal User Information Result Set

The **Extended Principal User Information Result Set** returns information on a specified principal or the principals that are members of a site group.

If *@PrincipalId* matches a principal, then the **Extended Principal User Information Result Set** MUST be returned once with a single row of data for the principal.

Otherwise, the **Extended Principal User Information Result Set** MUST be returned with zero rows, and if *@GetExpandedSTSGroup* is 1, another instance of the **Extended Principal User Information Result Set** MUST be returned, with one row of data for each principal within the site group.

| | |
|-------------------------------|-----------------|
| tp_ID | int, |
| tp_SystemID | varbinary(512), |
| tp_Title | nvarchar(255), |
| tp_Login | nvarchar(255), |
| tp_Email | nvarchar(255), |
| tp_Notes | nvarchar(1023), |
| tp_SiteAdmin | bit, |
| tp_DomainGroup | bit, |
| tp_Flags | int, |
| {tp_ExternalTokenLastUpdated} | datetime, |
| {tp_ExternalToken} | varbinary(max), |
| {tp_Token} | varbinary(max), |
| tp_Mobile | nvarchar(127); |

tp_ID: The user identifier of the principal.

tp_SystemID: The principal's **SystemId** (section [2.2.1.1.12](#)).

tp_Title: The principal's display name.

tp_Login: The principal's login name.

tp_Email: The principal's e-mail address.

tp_Notes: A longer descriptive text associated with the principal.

tp_SiteAdmin: Set to 1 if the principal is a site collection administrator; otherwise, 0.

tp_DomainGroup: Set to 1 if the principal is a domain group; otherwise, 0.

tp_Flags: Contains the **User Information Flags** value describing this principal.

{tp_ExternalTokenLastUpdated}: A **timestamp** in UTC format specifying the time when the **External Group Token** (section [2.2.3.2](#)) was last updated. This parameter MUST be NULL if *@GetExternalToken* is 0.

{tp_ExternalToken}: An **External Group Token** value specifying the domain group membership of the principal. This parameter MUST be NULL if *@GetExternalToken* is 0.

{tp_Token}: A **WSS User Token** (section [2.2.3.10](#)) value specifying the site group membership of the principal. This parameter MUST be NULL if *@GetSTSToken* is 0.

tp_Mobile: The principal's mobile phone number.

3.1.5.77 proc_SecGetPrincipalByLogin

The **proc_SecGetPrincipalByLogin** stored procedure is invoked to return security and attribute information for a principal (a user or domain group) identified by a specified login name.

```
PROCEDURE proc_SecGetPrincipalByLogin(  
    @SiteId                uniqueidentifier,  
    @Login                 nvarchar(255),  
    @GetSTSToken          bit                = 0,  
    @GetExternalToken     bit                = 0,  
    @RequestGuid          uniqueidentifier   = NULL OUTPUT  
);
```

@SiteId: The Site Collection Identifier for the site collection associated with the principal whose information is requested.

@Login: The login name of the principal. This parameter **MUST NOT** be NULL.

@GetSTSToken: A bit flag specifying whether to include site group membership information for the principal. If this parameter is set to 1, then a **WSS User Token** (section [2.2.3.10](#)) containing the principal's site group membership information **MUST** be returned in the **User Information Result Set**.

@GetExternalToken: A bit flag specifying whether to include domain group membership and related timestamp information for the principal. If this parameter is set to 1, then an **External Group Token** (section [2.2.3.2](#)) containing the principal's domain group membership information and a timestamp indicating the principal's most recent update time **MUST** be returned in the **User Information Result Set**.

@RequestGuid: The optional request identifier for the current request.

Return Values: The **proc_SecGetPrincipalByLogin** stored procedure returns an integer return code, which **MUST** be 0.

The **proc_SecGetPrincipalByLogin** stored procedure **MUST** return a single result set as follows.

3.1.5.77.1 User Information Result Set

The **User Information Result Set** returns security and attribute information about a specified principal. The **User Information Result Set** **MUST** be returned, and **MUST** contain one row if the **@Login** parameter matches an existing principal who is not marked as deleted in the **UserInfo Table** (section [2.2.6.10](#)); otherwise it **MUST** contain no rows.

| | |
|-------------------------------|-----------------|
| tp_ID | int, |
| tp_SystemID | varbinary(512), |
| tp_Title | nvarchar(255), |
| tp_Login | nvarchar(255), |
| tp_Email | nvarchar(255), |
| tp_Notes | nvarchar(1023), |
| tp_SiteAdmin | bit, |
| tp_DomainGroup | bit, |
| tp_Flags | int, |
| {tp_ExternalTokenLastUpdated} | datetime, |
| {tp_ExternalToken} | varbinary(max), |
| {tp_Token} | varbinary(max); |

tp_ID: The User Identifier for the specified principal.

tp_SystemID: The **SystemId** (section [2.2.1.1.12](#)) for the principal.

tp_Title: The display name of the principal.

tp_Login: The principal's login name.

tp_Email: The principal's email address.

tp_Notes: A descriptive text string associated with the principal.

tp_SiteAdmin: A bit set to 1 if the principal has administrator rights in the site collection; otherwise, 0.

tp_DomainGroup: A bit set to 1 if the principal is a domain group; otherwise 0, indicating the principal is a user.

tp_Flags: Contains the **User Information Flags** value describing this principal.

{tp_ExternalTokenLastUpdated}: A **datetime** in UTC format specifying the time when the external group token was last updated. This value **MUST** be NULL if the *@GetExternalToken* parameter is not set to 1.

{tp_ExternalToken}: An **External Group Token** (section [2.2.3.2](#)) value specifying the domain group membership of the principal. This value **MUST** be NULL if the *@GetExternalToken* parameter is not set to 1.

{tp_Token}: A **WSS User Token** value specifying the site group membership of the principal. This value **MUST** be NULL if the *@GetSTSToken* parameter is not set to 1.

3.1.5.78 **proc_SecGetPrincipalByLogin20**

The **proc_SecGetPrincipalByLogin20** stored procedure is invoked to return security principal information based on up to 20 separate login names.

```
PROCEDURE proc_SecGetPrincipalByLogin20 (
    @SiteId                uniqueidentifier,
    @PrincipalId01         nvarchar(255),
    @PrincipalId02         nvarchar(255),
    @PrincipalId03         nvarchar(255),
    @PrincipalId04         nvarchar(255),
    @PrincipalId05         nvarchar(255),
    @PrincipalId06         nvarchar(255),
    @PrincipalId07         nvarchar(255),
    @PrincipalId08         nvarchar(255),
    @PrincipalId09         nvarchar(255),
    @PrincipalId10         nvarchar(255),
    @PrincipalId11         nvarchar(255),
    @PrincipalId12         nvarchar(255),
    @PrincipalId13         nvarchar(255),
    @PrincipalId14         nvarchar(255),
    @PrincipalId15         nvarchar(255),
    @PrincipalId16         nvarchar(255),
    @PrincipalId17         nvarchar(255),
    @PrincipalId18         nvarchar(255),
    @PrincipalId19         nvarchar(255),
    @PrincipalId20         nvarchar(255),
```

```

        @RequestGuid                uniqueidentifier = NULL OUTPUT
    );

```

@SiteId: The Site Collection Identifier for the site collection that contains the security principals.

@PrincipalId##: The login names for Users to be returned.

@RequestGuid: The optional request identifier for the current request.

Return Values: The **proc_SecGetPrincipalByLogin20** stored procedure returns an integer return code which MUST be 0.

The **proc_SecGetPrincipalByLogin20** stored procedure MUST return one result set of security principal information for each non-NULL **@PrincipalId##**:

3.1.5.78.1 User Information Result Set

The **User Information Result Set** returns User information on a specified security principal. The **User Information Result Set** MUST return one row if the **@PrincipalId##** matches a security principal's ID, otherwise it MUST contain no rows. The **User Information Result Set** is defined in the **proc_SecGetPrincipalByLogin User Information Result Set** (section [3.1.5.19.5](#)).

3.1.5.79 proc_SecGetPrincipalDisplayInformation20

The **proc_SecGetPrincipalDisplayInformation20** stored procedure is invoked to return security principal or site group information for up to 20 principal identifiers.

```

PROCEDURE proc_SecGetPrincipalDisplayInformation20(
    @SiteId                uniqueidentifier,
    @WebId                 uniqueidentifier,
    @PrincipalId01         int,
    @PrincipalId02         int,
    @PrincipalId03         int,
    @PrincipalId04         int,
    @PrincipalId05         int,
    @PrincipalId06         int,
    @PrincipalId07         int,
    @PrincipalId08         int,
    @PrincipalId09         int,
    @PrincipalId10         int,
    @PrincipalId11         int,
    @PrincipalId12         int,
    @PrincipalId13         int,
    @PrincipalId14         int,
    @PrincipalId15         int,
    @PrincipalId16         int,
    @PrincipalId17         int,
    @PrincipalId18         int,
    @PrincipalId19         int,
    @PrincipalId20         int,
    @RequestGuid           uniqueidentifier = NULL OUTPUT
);

```

@SiteId: The site collection identifier for the site collection containing the security principals and the Security Groups to be listed.

@WebId: A site identifier for a site. This parameter is ignored.

@PrincipalId##: The identifier for a security principal or a site group to be returned. Result sets are returned for each non-NULL **@PrincipalId##** parameter.

@RequestGuid: The optional request identifier for the current request.

Return Values: The **proc_SecGetPrincipalDisplayInformation20** stored procedure returns an integer return code which MUST be 0.

The **proc_SecGetPrincipalDisplayInformation20** stored procedure MUST return one or two result sets for each non-NULL **@PrincipalId##**:

3.1.5.79.1 Site Group Principal Display Information Result Set

The **Site Group Principal Display Information Result Set** returns information on a specified **@PrincipalId##**. The **@PrincipalId##** MUST match the ID of either a site group or a principal. If **@PrincipalId##** matches the ID of a site group, then the **Site Group Principal Display Information Result Set** MUST return one row. If the **@PrincipalId##** matches the ID of a principal, then the **Site Group Principal Display Information Result Set** MUST have no rows.

| | |
|------------------|-----------------|
| IsUser | bit, |
| IsSiteGroup | bit, |
| UserID | int, |
| UserSID | varbinary(512), |
| UserName | nvarchar(255), |
| UserLogin | nvarchar(255), |
| UserEmail | nvarchar(255), |
| UserNotes | nvarchar(1023), |
| UserSiteAdmin | bit, |
| UserDomainGroup | bit, |
| GroupID | int, |
| GroupName | nvarchar(255), |
| GroupDescription | nvarchar(512), |
| GroupOwnerID | int, |
| GroupOwnerIsUser | bit, |
| GroupType | tinyint; |

IsUser: MUST be 0.

IsSiteGroup: MUST be 1.

UserID: MUST be NULL.

UserSID: MUST be NULL.

UserName: MUST be NULL.

UserLogin: MUST be NULL.

UserEmail: MUST be NULL.

UserNotes: MUST be NULL.

UserSiteAdmin: MUST be NULL.

UserDomainGroup: MUST be NULL.

GroupID: The site group identifier. MUST match *@PrincipalId##*.

GroupName: The display name of the site group, specified by *@GroupID*.

GroupDescription: The description of the site group specified by *@GroupID*.

GroupOwnerID: The identifier of the user who owns the site group, specified by *@GroupID*.

GroupOwnerIsUser: A bit set to 1 if the user who owns of the site group is a principal; otherwise it MUST be 0.

GroupType: MUST be 0.

3.1.5.79.2 Security Principal Display Information Result Set

If *@PrincipalId##* matches the ID of a site group, then the **Security Principal Display Information Result Set** MUST not be returned. If the *@PrincipalId##* matches the ID of a security principal, then the **Security Principal Display Information Result Set** MUST have one row for the matching security principal.

| | |
|------------------|-----------------|
| IsUser | bit, |
| IsSiteGroup | bit, |
| UserID | int, |
| UserSID | varbinary(512), |
| UserName | nvarchar(255), |
| UserLogin | nvarchar(255), |
| UserEmail | nvarchar(255), |
| UserNotes | nvarchar(1023), |
| UserSiteAdmin | bit, |
| UserDomainGroup | bit, |
| UserFlags | int, |
| GroupID | int, |
| GroupName | nvarchar(255), |
| GroupDescription | nvarchar(512), |
| GroupOwnerID | int, |
| GroupOwnerIsUser | bit, |
| GroupType | tinyint; |

IsUser: MUST be 1.

IsSiteGroup: MUST be 0.

UserID: The user identifier of the principal. MUST match *@PrincipalId##*.

UserSID: The **SystemID** of the principal.

UserName: The display name of the principal.

UserLogin: The login name of the principal.

UserEmail: The email address of the principal.

UserNotes: Description text associated with the principal.

UserSiteAdmin: Set to 1 to indicate that the principal is a site collection administrator, otherwise 0.

UserDomainGroup: Set to 1 to indicate that the principal is a domain group, otherwise 0.

UserFlags: Contains the user information flags value describing this principal.

GroupID: MUST be NULL.

GroupName: MUST be NULL.

GroupDescription: MUST be NULL.

GroupOwnerID: MUST be NULL.

GroupOwnerIsUser: MUST be NULL.

GroupType: MUST be NULL.

3.1.5.80 **proc_SecGetRoleAssignments**

The **proc_SecGetRoleAssignments** stored procedure is invoked to request the **WSS ACE** (section [2.2.3.5](#)) for a specified security scope in a site collection.

```
PROCEDURE proc_SecGetRoleAssignments (  
    @SiteId                uniqueidentifier,  
    @ScopeId              uniqueidentifier,  
    @RequestGuid          uniqueidentifier = NULL OUTPUT  
);
```

@SiteID: The site collection identifier of the site collection containing the requested security scope.

@ScopeID: The scope identifier of the security scope containing the requested WSS ACEs.

@RequestGuid: The optional request identifier for the current request.

Return Values: The **proc_SecGetRoleAssignments** stored procedure returns an integer return code which MUST be 0.

The **proc_SecGetRoleAssignments** stored procedure MUST return one result set. It will return zero or more rows.

3.1.5.80.1 **WSSACE Result Set**

The **WSSACE Result Set** MUST return one row for each role assignment matching the given security scope within the site collection. Each row represents a **WSS ACE** (section [2.2.3.5](#)).

```
PrincipalId                int,  
PermMask                  bigint;
```

PrincipalId: A 4 byte signed integer specifying the user identifier of the principal for this **WSS ACE**.

PermMask: A **WSS Rights Mask** (section [2.2.2.15](#)) that contains the list of rights that is granted to the principal.

3.1.5.81 **proc_SecGetRoleBindingsForAllPrincipals**

The **proc_SecGetRoleBindingsForAllPrincipals** stored procedure is invoked to list the role assignments for all principals in a security scope.

```
PROCEDURE proc_SecGetRoleBindingsForAllPrincipals (
    @SiteId                uniqueidentifier,
    @ScopeId               uniqueidentifier,
    @RequestGuid           uniqueidentifier = NULL OUTPUT
);
```

@SiteId: The site collection identifier of the site collection containing the security scope.

@ScopeId: The scope identifier of the security scope containing the role assignments.

@RequestGuid: The optional request identifier for the current request.

Return Values: The **proc_SecGetRoleBindingsForAllPrincipals** stored procedure MUST return an integer return code of 0.

The **proc_SecGetRoleBindingsForAllPrincipals** stored procedure MUST return one result set as follows.

3.1.5.81.1 **Role Assignment Result Set**

The **Role Assignment Result Set** MUST return one row for each undeleted principal in the scope.

```
RoleId                int,
PrincipalId           int;
```

RoleId: The role identifier of a role associated with the role assignment.

PrincipalId: The user identifier of the principal.

3.1.5.82 **proc_SecGetRoleDefs**

proc_SecGetRoleDefs is invoked to retrieve role definition information for items in the specified site collection and scope.

```
PROCEDURE proc_SecGetRoleDefs (
    @SiteId                uniqueidentifier,
    @ScopeId               uniqueidentifier,
    @RequestGuid           uniqueidentifier = NULL OUTPUT
);
```

@SiteId: The site collection identifier for the desired site collection. This parameter MUST correspond to a valid site collection.

@ScopeId: The scope identifier of the desired scope.

@RequestGuid: The optional request identifier for the current request.

Return Values: The **proc_SecGetRoleDefs** stored procedure MUST return an integer return code of 0, and MUST return a role definition result set.

3.1.5.82.1 Role Definition Result Set

The **Role Definition Result Set** contains a list of role definitions. The **Role Definition Result Set** MUST contain one row for each role defined in the specified site collection at the specified scope.

| | |
|-----------------|-------------------|
| RoleId | int, |
| Title | nvarchar(255), |
| Description | nvarchar(512), |
| Hidden | bit, |
| RoleOrder | int, |
| Type | tinyint, |
| WebId | uniqueidentifier, |
| {PermMaskUpper} | int, |
| {PermMaskLower} | int, |
| WebGroupId | int; |

RoleId: The role identifier for the role.

Title: The display name of the role.

Description: A user-defined description of the role.

Hidden: Implementation-specific bit flag used to inform the front-end Web server whether or not to display the role definition.

RoleOrder: Specifies the order in which roles MUST be displayed in the front-end Web server. Roles MUST be sorted first in ascending **RoleOrder**, then by descending **Type**.

Type: The **Role Definition Type** (section [2.2.1.2.16](#)) of the role.

WebId: The Site Identifier for the site within the site collection to which the role is assigned.

{PermMaskUpper}: An integer containing the high-order 32 bits of a **WSS Rights Mask** (section [2.2.2.15](#)) defining the permissions for the role.

{PermMaskLower}: An integer containing the low-order 32 bits of a **WSS Rights Mask** defining the permissions for the role.

WebGroupId: If the role was upgraded from a site group, then **WebGroupId** MUST be the identifier of the site group from which it was upgraded, otherwise, it MUST be -1.

3.1.5.83 proc_SecGetSecurityInfo

The **proc_SecGetSecurityInfo** stored procedure retrieves security permissions information about a document. The document can be specified using its document identifier (2) or its URL.

```
PROCEDURE proc_SecGetSecurityInfo(  
    @SiteId                uniqueidentifier,  
    @WebId                 uniqueidentifier,  
    @Url                   nvarchar(260),  
    @ThresholdCount        int,  
    @DocId                 uniqueidentifier,  
    @RequestGuid           uniqueidentifier = NULL OUTPUT  
);
```

@SiteId: The **Site Collection Identifier** (section [2.2.1.1.9](#)) of the site collection containing the document.

@WebId: The **Site Identifier** (section [2.2.1.1.11](#)) of the site (2) containing the document. This parameter MUST be ignored.

@Url: The store-relative form URL for the document. The **@Url** parameter MUST be NULL to specify the document with the **@DocID** parameter.

@ThresholdCount: If **@Url** is a folder and the list (1) does not have more list items than **@ThresholdCount**, the **BigListFolder** field in the **Security Information Result Set** (section [3.1.5.83.1](#)) MUST be zero.

@DocId: The document identifier (2) of the document. The **@DocId** parameter MUST be ignored if **@Url** is not NULL.

@RequestGuid: The optional request identifier for the current request.

Return Values: The **proc_SecGetSecurityInfo** stored procedure returns an integer return code which MUST be listed in the following table.

| Value | Description |
|-------|-----------------------------|
| 0 | Successful execution. |
| 3 | The document was not found. |

The **proc_SecGetSecurityInfo** stored procedure MUST return a single **Security Information Result Set** (section [3.1.5.83.1](#)) upon successful execution, or no result sets if the document is not found.

3.1.5.83.1 Security Information Result Set

The **Security Information Result Set** returns information about the security permissions on the document. The **Security Information Result Set** MUST be returned only if the document exists, and MUST return one row of information.

| | |
|-------------------|-------------------|
| {ScopeId} | uniqueidentifier, |
| {ScopeUrl} | nvarchar(260), |
| {IsScope} | bit, |
| Acl | varbinary(max), |
| AnonymousPermMask | bigint, |
| {BigListFolder} | bit; |
| {ListId} | uniqueidentifier |

{ScopeId}: Contains the scope identifier of the scope that contains the document.

{ScopeUrl}: The store-relative form URL of the scope that contains the document.

{IsScope}: A flag indicating that the document is the securable object at the root of the scope. This value MUST be set to 1 if **ScopeUrl** is the store-relative form URL of the document; otherwise, the value MUST be 0.

Acl: The access control list (ACL) of the scope that contains the document.

AnonymousPermMask: The **WSS Rights Mask** (section [2.2.2.15](#)) in effect for anonymous users in the scope.

{BigListFolder}: A flag indicating whether or not the list is considered too big for non-administrators. If *@Url* is not a folder, then **BigListFolder** MUST be 0. If the list is not throttled, **BigListFolder** MUST be 0. If the list does not contain more list items than *@ThresholdCount*, then **BigListFolder** MUST be 0. Otherwise, **BigListFolder** MUST be 1.

{ListId}: The list identifier of the list containing the document.

3.1.5.84 proc_SecGetSiteAdmins

The **proc_SecGetSiteAdmins** stored procedure is invoked to return a list of all site collection administrators not marked as deleted.

```
PROCEDURE proc_SecGetSiteAdmins (  
    @SiteId                uniqueidentifier,  
    @RequestGuid           uniqueidentifier      OUTPUT  
);
```

@SiteId: The site collection identifier of the site collection containing the site collection administrators.

@RequestGuid: The optional request identifier for the current request.

Return Values: The **proc_SecGetSiteAdmins** stored procedure returns an integer return code, which MUST be 0 and it MUST return a single result set

3.1.5.84.1 Site Administrators Result Set

The **Site Administrators Result Set** returns a list of all site collection administrators not marked as deleted. The **Site Administrators Result Set** MUST be returned. The **Site Administrators Result Set** MUST return one row per site collection administrator.

| | |
|----------------|-----------------|
| tp_Id | int, |
| tp_SystemID | varbinary(512), |
| tp_Title | nvarchar(255), |
| tp_Login | nvarchar(255), |
| tp_Email | nvarchar(255), |
| tp_Notes | nvarchar(1023), |
| tp_SiteAdmin | bit, |
| tp_DomainGroup | bit, |
| tp_Flags | int; |

tp_Id: The user identifier of the security principal who is a site collection administrator.

tp_SystemID: The **SystemID** of the security principal.

tp_Title: The name of the security principal, used for display on the front-end Web server.

tp_Login: The login name of the security principal, for example, EXAMPLE\username.

tp_Email: The email address of the security principal, for example, "username@mail.example.com".

tp_Notes: Notes associated with the site collection administrator.

tp_SiteAdmin: This value is set to 1 if the security principal is a site collection administrator. This value is set to 0 if the security principal is not a site collection administrator.

tp_DomainGroup: This value is set to 1 if the security principal is a domain group. This value is set to 0 if the security principal is not a domain group.

tp_Flags: A 4-byte integer bit mask determining the security principal's options as specified in **User Info Flags** (section [2.2.2.12](#)).

3.1.5.85 **proc_SecGetSiteGroupById**

The **proc_SecGetSiteGroupById** stored procedure gets information about a site group given its ID.

```
PROCEDURE proc_SecGetSiteGroupById(  
    @SiteId                uniqueidentifier,  
    @GroupId                int,  
    @RequestGuid            uniqueidentifier = NULL OUTPUT  
);
```

@SiteId: The Site Collection Identifier of the site collection containing the site group.

@GroupId: The identifier of the site group.

@RequestGuid: The optional request identifier for the current request.

Return Values: The **proc_SecGetSiteGroupById** stored procedure MUST return an integer return code of 0.

The **proc_SecGetSiteGroupById** stored procedure MUST return a single result set.

3.1.5.85.1 **Site Group Result Set**

The **Site Group Result Set** returns information about a site group. The **Site Group Result Set** MUST contain 1 row of site group information if the **Sec_SiteGroupsView.SiteWebID** equals **@SiteId** and **Sec_SiteGroupsView.ID** equals **@GroupId**; otherwise, 0 rows MUST be returned.

The **Site Group Result Set** is defined using T-SQL syntax, in the **Sec_SiteGroupsView** (section [2.2.6.5](#)).

3.1.5.86 **proc_SecGetSiteGroupByTitle**

The **proc_SecGetSiteGroupByTitle** stored procedure is invoked to get site group information for the site group with the specified user-friendly name.

```
PROCEDURE proc_SecGetSiteGroupByTitle(  
    @SiteId                uniqueidentifier,  
    @Title                  nvarchar(255),  
    @RequestGuid            uniqueidentifier = NULL OUTPUT  
);
```

@SiteId: The Site Collection Identifier of the site collection containing the site group.

@Title: The user-friendly name of the site group.

@RequestGuid: The optional request identifier for the current request.

Return Values: The **proc_SecGetSiteGroupByTitle** stored procedure MUST return an integer return code of 0 and it MUST return a single result set.

3.1.5.86.1 Site Group Information Result Set

The **Site Group Information Result Set** returns the available site group information for the specified site group. The **Site Group Information Result Set** MUST contain one row of site group information if the *@SiteID* parameter value and the *@Title* parameter value match an existing site group; otherwise, 0 rows MUST be returned.

The **Site Group Information Result Set** schema is defined in the **Sec_SiteGroupsView** (section [2.2.6.5](#)).

3.1.5.87 proc_SecGetSiteGroupByTitle20

The **proc_SecGetSiteGroupByTitle20** stored procedure provides information about site groups in bulk, as specified by a set of up to 20 site group titles.

```
PROCEDURE proc_SecGetSiteGroupByTitle20 (
    @SiteId                uniqueidentifier,
    @PrincipalId01         nvarchar(255),
    @PrincipalId02         nvarchar(255),
    @PrincipalId03         nvarchar(255),
    @PrincipalId04         nvarchar(255),
    @PrincipalId05         nvarchar(255),
    @PrincipalId06         nvarchar(255),
    @PrincipalId07         nvarchar(255),
    @PrincipalId08         nvarchar(255),
    @PrincipalId09         nvarchar(255),
    @PrincipalId10         nvarchar(255),
    @PrincipalId11         nvarchar(255),
    @PrincipalId12         nvarchar(255),
    @PrincipalId13         nvarchar(255),
    @PrincipalId14         nvarchar(255),
    @PrincipalId15         nvarchar(255),
    @PrincipalId16         nvarchar(255),
    @PrincipalId17         nvarchar(255),
    @PrincipalId18         nvarchar(255),
    @PrincipalId19         nvarchar(255),
    @PrincipalId20         nvarchar(255),
    @RequestGuid           uniqueidentifier
);
```

@SiteId: The Site Collection Identifier for the site collection containing the specified site groups.

@PrincipalId##: Twenty **Site Group Title** fields (01 - 20).

@RequestGuid: The optional request identifier for the current request.

Return Values: The **proc_SecGetSiteGroupByTitle20** stored procedure MUST return an integer return code of 0.

The **proc_SecGetSiteGroupByTitle20** stored procedure MUST return one result set for each NON-NULL *@PrincipalId##*.

3.1.5.87.1 Site Group Information Result Set

The **Site Group Information Result Set** returns once per each NON-NULL *@PrincipalId##*, and the **Site Group Information Result Set** MUST contain one row of site group information if the *@SiteID* parameter value and the *@PrincipalId##* parameter value match an existing site group; otherwise, zero rows MUST be returned.

The **Site Group Information Result Set** is defined using T-SQL syntax, as defined by the **Sec_SiteGroupsView** (section [2.2.6.5](#)).

3.1.5.88 proc_SecGetUserAccountDirectoryPath

The **proc_SecGetUserAccountDirectoryPath** stored procedure is invoked to return the User Account Directory Path of a specified site collection.

This stored procedure is called when a user has specific user restrictions and the **User Account Directory Path** is required along other user information.

```
PROCEDURE proc_SecGetUserAccountDirectoryPath(  
    @SiteId                uniqueidentifier,  
    @RequestGuid           uniqueidentifier    OUTPUT  
);
```

@SiteId: The site collection identifier of the site collection.

@RequestGuid: The optional request identifier for the current request.

Return Code Values: The **proc_SecGetUserAccountDirectoryPath** stored procedure returns an integer return code, which MUST be 0.

The **proc_SecGetUserAccountDirectoryPath** stored procedure MUST return one result set.

3.1.5.88.1 User Account Directory Path Result Set

The **User Account Directory Path Result Set** returns the User Account Directory Path for the site collection. The **User Account Directory Path Result Set** MUST contain one row when the specified site collection exists, and it MUST contain zero rows when the specified site collection does not exist.

```
UserAccountDirectoryPath    nvarchar(512);
```

UserAccountDirectoryPath: Contains the User Account Directory Path for the site collection.

3.1.5.89 proc_SecGetUserPermissionOnGroup

The **proc_SecGetUserPermissionOnGroup** stored procedure is invoked to determine what permissions the requesting user has within a specified site group.

```
PROCEDURE proc_SecGetUserPermissionOnGroup(  
    @SiteId                uniqueidentifier,  
    @GroupId               int,  
    @UserId                int,
```

```

        @BelongsToGroup          bit,
        @CanViewMembership       bit          OUTPUT,
        @CanEditMembership       bit          OUTPUT,
        @GroupOwnerId            int          OUTPUT,
        @IsExplicitlyInMembership bit          OUTPUT,
        @RequestGuid             uniqueidentifier OUTPUT
    );

```

@SiteId: The site collection identifier of the site collection containing the site group specified by **@GroupId**.

@GroupId: The site group identifier of the site group whose permissions are to be returned.

@UserId: The user identifier of the current user making the request for permissions.

@BelongsToGroup: When this parameter is set to 1, it indicates that the user specified by **@UserId** belongs to the site group specified by **@GroupId**. This is used to determine access to site group information, as site groups can restrict membership information to only members of the site group.

@CanViewMembership: When this parameter is set to 1, it indicates that the user specified by **@UserId** is permitted to view site group membership.

@CanEditMembership: When this parameter is set to 1, it indicates that the user specified by **@UserId** is permitted to edit site group membership.

@GroupOwnerId: The user identifier of the user who owns the site group specified by **@GroupId**.

@IsExplicitlyInMembership: When this parameter is set to 1, it indicates that the user specified by **@UserId** is directly a member of the site group specified by **@GroupId** and not conferred membership through an intermediate site group membership.

@RequestGuid: The optional request identifier for the current request.

Return Values: The **proc_SecGetUserPermissionOnGroup** stored procedure returns an integer return code, which MUST be listed in the following table.

| Value | Description |
|-------|--|
| 0 | Successful execution. |
| 1319 | The site group was not found for the provided @GroupId and @SiteId . |

The **proc_SecGetUserPermissionOnGroup** stored procedure MUST return zero result sets.

3.1.5.90 **proc_SecGetWebsAndListsWithUniquePermissions**

The **proc_SecGetWebsAndListsWithUniquePermissions** stored procedure is invoked to return a list of sites and lists that have unique permissions.

```

PROCEDURE proc_SecGetWebsAndListsWithUniquePermissions (
    @SiteId          uniqueidentifier,
    @WebId           uniqueidentifier,
    @WebUrl          nvarchar(260),
    @RequestGuid     uniqueidentifier          OUTPUT
);

```

@SiteId: The site collection identifier of the site collection.

@WebId: The site identifier of the site to query.

@WebUrl: The URL of the site collection.

@RequestGuid: The optional request identifier for the current request.

Return Values: The **proc_SecGetWebsAndListsWithUniquePermissions** stored procedure returns an integer return code which MUST be 0.

Result Sets: **proc_SecGetWebsAndListsWithUniquePermissions** MUST return four result sets:

- **Site Information Result Set** (section [3.1.5.90.1](#))
- **Sub Site Information Result Set** (section [3.1.5.90.2](#))
- **Site List Information Result Set** (section [3.1.5.90.3](#))
- **Sub Site List Information Result Set** (section [3.1.5.90.4](#))

3.1.5.90.1 Site Information Result Set

The **Site Information Result Set** MUST return one row if the site has unique permissions. The **Site Information Result Set** MUST return 0 rows if the site has no unique permissions.

| | |
|---------|-------------------|
| FullUrl | nvarchar(256), |
| Id | uniqueidentifier, |
| Title | nvarchar(255); |

FullUrl: The URL of the site specified by **@WebId**.

Id: The site identifier of the site specified by **@WebId**.

Title: The title associated with the site specified by **@WebId**.

3.1.5.90.2 Sub Site Information Result Set

The **Sub Site Information Result Set** returns information about each subsite of the site specified by **@WebId**. The result set MUST return 0 or more rows. There MUST be one row per subsite that has unique permissions.

| | |
|---------|-------------------|
| FullUrl | nvarchar(256), |
| Id | uniqueidentifier, |
| Title | nvarchar(255); |

FullUrl: The URL of the subsite.

Id: The site identifier of the subsite.

Title: The title associated with the subsite.

3.1.5.90.3 Site List Information Result Set

The **Site List Information Result Set** returns information about lists in the site specified by *@WebId*. The number of rows returned MUST be the same as the number of lists which either have unique permissions or contain documents that have unique permissions.

| | |
|---------------------|-------------------|
| FullUrl | nvarchar(256), |
| Id | uniqueidentifier, |
| Title | nvarchar(255), |
| {ListRootFolderUrl} | nvarchar(260), |
| tp_ID | uniqueidentifier, |
| tp_Title | nvarchar(25), |
| HasUniquePerm | bit; |

FullUrl: The URL of the site specified by *@WebId*.

Id: The site identifier of the site specified by *@WebId*.

Title: The title associated with the site specified by *@WebId*.

{ListRootFolderUrl}: Root folder of the list which has unique permissions in the site specified by *@WebId*.

tp_ID: The list identifier of the list.

tp_Title: The list title.

HasUniquePerm: This parameter is set to 0 if the list permissions is as the same as the site. This parameter is set to 1 if the list permissions is not as the same as the site.

3.1.5.90.4 Sub Site List Information Result Set

The **Sub Site List Information Result Set** returns information about lists in the subsite that is in the site specified by the *@WebId*.

There MUST be a row for each list in the subsite of the site specified by *@WebId* which either have unique permissions or contain documents that have unique permissions.

| | |
|---------------------|-------------------|
| FullUrl | nvarchar(256), |
| Id | uniqueidentifier, |
| Title | nvarchar(255), |
| {ListRootFolderUrl} | nvarchar(260), |
| tp_ID | uniqueidentifier, |
| tp_Title | nvarchar(25), |
| HasUniquePerm | bit; |

FullUrl: The URL of the site specified by the *@WebId*.

Id: The site identifier of the site specified by the *@WebId*.

Title: The title associated with the site.

{ListRootFolderUrl}: Root folder of the list which has unique permissions in the site.

tp_ID: The list identifier of the list.

tp_Title: The list title.

HasUniquePerm: This parameter is set to 0 if the list permissions is as the same as the site. This parameter is set to 1 if the list permissions is not as the same as the site.

3.1.5.91 **proc_SecListAllSiteMembers**

The **proc_SecListAllSiteMembers** stored procedure provides information about all non-deleted security principals in the specified site collection.

```
PROCEDURE proc_SecListAllSiteMembers (
    @SiteID                uniqueidentifier,
    @RequestGuid           uniqueidentifier    OUTPUT
);
```

@SiteID: The site collection identifier of the site collection containing the requested security principal information.

@RequestGuid: The optional request identifier for the current request.

Return Values: The **proc_SecListAllSiteMembers** stored procedure returns an integer return code, which **MUST** be 0 and it **MUST** return a single result set.

3.1.5.91.1 **User Information Result Set**

The **User Information Result Set** returns information about the non-deleted users directly associated with the site collection specified by **@SiteID**. Zero or more rows **MUST** be returned. There **MUST** be one row per non-deleted user in the site collection specified by **@SiteID**.

| | |
|----------------|-----------------|
| tp_Id | int, |
| tp_SystemID | varbinary(512), |
| tp_Title | nvarchar(255), |
| tp_Login | nvarchar(255), |
| tp_Email | nvarchar(255), |
| tp_Notes | nvarchar(1023), |
| tp_SiteAdmin | bit, |
| tp_DomainGroup | bit, |
| tp_Flags | int; |

tp_Id: The user identifier that uniquely identifies the security principal with the site collection.

tp_SystemID: The **SystemID** of the security principal.

tp_Title: The display name of the security principal.

tp_Login: The login name of the security principal.

tp_Email: The email address of the security principal, for example, "username@mail.example.com".

tp_Notes: Notes associated with the security principal.

tp_SiteAdmin: This value is set to 1 if the security principal is a site collection administrator. This value is set to 0 if the security principal is not a site collection administrator.

tp_DomainGroup: This value is set to 1 if the security principal is a domain group. This value is set to 0 if the security principal is not a domain group.

tp_Flags: A 4-byte integer bit mask specifying the security principal's options as specified in **UserInfo Flags** (section [2.2.2.12](#)).

3.1.5.92 proc_SecListAllWebMembers

The **proc_SecListAllWebMembers** stored procedure is invoked to list all non-deleted user and domain group accounts registered with a specified site.

```
PROCEDURE proc_SecListAllWebMembers(  
    @SiteId                uniqueidentifier,  
    @WebId                 uniqueidentifier,  
    @RequestGuid           uniqueidentifier    OUTPUT  
);
```

@SiteId: The site collection identifier of the site collection containing the site specified by **@WebId**.

@WebId: The site identifier of the site to query for members (1).

@RequestGuid: The optional request identifier for the current request.

Return Values: The **proc_SecListAllWebMembers** stored procedure returns an integer return code which **MUST** be 0 and it **MUST** return a single result set.

3.1.5.92.1 Site Membership Result Set

The **Site Membership Result Set** returns a list of all non-deleted users or domain groups registered with the specified site. The **Site Membership Result Set** **MUST** return zero rows if the site specified by **@WebId** has no members (1), otherwise it **MUST** contain one row for each member (1) if **@WebId** matches an existing site within the site collection specified by **@SiteId**.

| | |
|----------------|-----------------|
| tp_Id | int, |
| tp_SystemID | varbinary(512), |
| tp_Title | nvarchar(255), |
| tp_Login | nvarchar(255), |
| tp_Email | nvarchar(255), |
| tp_Notes | nvarchar(1023), |
| tp_SiteAdmin | bit, |
| tp_DomainGroup | bit, |
| tp_Flags | int; |

tp_ID: The user identifier of the security principal.

tp_SystemID: The **SystemID** of the security principal.

tp_Title: The display name of the security principal.

tp_Login: The login name of the security principal.

tp_Email: The email address of the security principal.

tp_Notes: A descriptive text associated with the security principal.

tp_SiteAdmin: Contains a bit flag set to 1 if the security principal is a site collection administrator. This value is set to 0 if the user is not a site collection administrator.

tp_DomainGroup: Contains a bit flag set to 1 if the security principal is a domain group. This value is set to 0 if the security principal is not for a domain group.

tp_Flags: A 4-byte integer bit mask determining the security principal's options as specified in **UserInfo Flags** (section [2.2.2.12](#)).

3.1.5.93 **proc_SecListGroupsWithRole**

The **proc_SecListGroupsWithRole** stored procedure is invoked to list all site groups that have the specified role.

```
PROCEDURE proc_SecListGroupsWithRole (
    @SiteId                uniqueidentifier,
    @ScopeId               uniqueidentifier,
    @RoleId                 int,
    @RequestGuid           uniqueidentifier
);
```

@SiteId: The Site Collection Identifier of the site collection that contains the site groups that have the role.

@ScopeId: The Scope Identifier of the scope containing the role.

@RoleId: Specifies the Role Identifier for the role.

@RequestGuid: The optional request identifier for the current request.

Return Values: The **proc_SecListGroupsWithRole** stored procedure returns an integer return code which MUST be 0.

The **proc_SecListGroupsWithRole** stored procedure MUST return 1 result set.

3.1.5.93.1 **Site Group Information Result Set**

The **Site Group Information Result Set** returns the collection of site groups that have the specified role. The **Site Group Information Result Set** MUST be empty if either the site collection, role, or scope are not found, or if no site groups have the specified role in the specified scope. Otherwise, the **Site Group Information Result Set** MUST have one row per site group. The **Site Group Information Result Set** schema is defined in the **Sec_SiteGroupsView** (section [2.2.6.5](#)).

3.1.5.94 **proc_SecListScopeGroups**

The **proc_SecListScopeGroups** stored procedure is invoked to list all site groups that have role assignments in a specified scope.

```
PROCEDURE proc_SecListScopeGroups (
    @SiteId                uniqueidentifier,
    @ScopeId               uniqueidentifier,
    @RequestGuid           uniqueidentifier
);
```

@SiteId: The Site Collection Identifier of the site collection which contains the scope whose site groups with role assignments are being listed.

@ScopeId: The Scope Identifier of the specified scope.

@RequestGuid: The optional request identifier for the current request.

Return Values: The **proc_SecListScopeGroups** stored procedure returns an integer return code which MUST be 0.

The **proc_SecListScopeGroups** stored procedure MUST return a single result set as defined in the following section.

3.1.5.94.1 Site Groups Result Set

The **Site Groups Result Set** contains all site group information for site groups with a role assignment in the specified scope. The **Site Groups Result Set** MUST be empty if either the site collection or scope are not found, or if no site groups have role assignments in the specified scope. Otherwise, one row MUST be returned for each site group in the site collection which has a role assignment in the specified scope.

The **Site Groups Result Set** is the same as the view defined in the **Sec_SiteGroupsView** (section [2.2.6.5](#)).

3.1.5.95 proc_SecListScopeUsers

The **proc_SecListScopeUsers** stored procedure is invoked to list information about users and domain groups with a direct role assignment association with the specified scope, rather than by membership in a site group with a role assignment association with the scope.

```
PROCEDURE proc_SecListScopeUsers (  
    @SiteId                uniqueidentifier,  
    @ScopeId              uniqueidentifier,  
    @RequestGuid          uniqueidentifier  
);
```

@SiteId: The site collection identifier of the site collection containing the scope.

@ScopeId: The scope identifier of the scope for which information about users with role assignments is requested.

@RequestGuid: The optional request identifier for the current request.

Return Values: The **proc_SecListScopeUsers** stored procedure MUST return an integer return code of 0, and it MUST return a single result set with 0 or more rows.

3.1.5.95.1 User Information Result Set

The **User Information Result Set** returns information about the users and domain groups directly associated with the specified scope through a role assignment. The **User Information Result Set** MUST contain 1 row for each non-deleted user or domain group directly associated with the specified scope through a role assignment. The **User Information Result Set** MUST contain 0 rows if no users or domain groups are directly associated with the specified scope, or if the parameters *@SiteId* or *@ScopeId* do not match existing site collection or scope identifiers, respectively.

The **User Information Result Set** is defined in the Common Result Sets **Principal User Information Result Set** (section [2.2.4.19](#)).

3.1.5.96 **proc_SecListSiteGroupMembership**

The **proc_SecListSiteGroupMembership** stored procedure lists members (1) in a specified site group. To view membership, the site group MUST be set to allow everyone to view membership, or the current user MUST belong to the site group, be a site auditor, or be the site owner.

```
PROCEDURE proc_SecListSiteGroupMembership (  
    @SiteId                uniqueidentifier,  
    @GroupId                int,  
    @CurrentUserId         int,  
    @SiteAuditor           bit,  
    @BelongsToGroup        bit,  
    @GroupOwnerId          int,  
    @CurrentUserIsOwner    bit,  
    @RequestGuid           uniqueidentifier  
);
```

@SiteId: The site collection identifier of the site collection containing the site group.

@GroupId: The identifier of the site group.

@CurrentUserId: The identifier of the current user. This is used to determine privileges.

@SiteAuditor: A bit set to 1 if the current user is a site auditor. This is used to determine privileges.

@BelongsToGroup: A bit set to 1 if the current user is a member of the site group. This is used to determine privileges.

@GroupOwnerId: The identifier of the owner of the site group. This is used to determine privileges.

@CurrentUserIsOwner: A bit set to 1 if the current user is the owner of the site group. This is used to determine privileges.

@RequestGuid: The optional request identifier for the current request.

Return Values: The **proc_SecListSiteGroupMembership** stored procedure returns an integer return code which MUST be listed in the following table.

| Value | Description |
|-------|--|
| 0 | Successful execution. |
| 5 | The User does not have privileges to view site group membership. |

The **proc_SecListSiteGroupMembership** stored procedure MUST return a single result set.

3.1.5.96.1 **User Information Result Set**

The **User Information Result Set** MUST either be empty or include 1 row of information for each member of the site group. If the user specified by **@CurrentUserId** does not have privileges to view membership, then the **User Information Result Set** will be empty. To view membership, the site group MUST be set to allow everyone to view membership, or the current user MUST belong to the site group, be a site auditor, or be the site owner.

The **User Information Result Set** is defined the Common Result Sets **Principal User Information Result Set** (section [2.2.4.19](#)).

3.1.5.97 **proc_SecListSiteGroups**

The **proc_SecListSiteGroups** stored procedure is invoked to list site group information for a specified site collection.

```
PROCEDURE proc_SecListSiteGroups (  
    @SiteId                uniqueidentifier,  
    @RequestGuid           uniqueidentifier  
);
```

@SiteId: The site collection identifier of the site collection containing the site groups to list.

@RequestGuid: The optional request identifier for the current request.

Return Values: The **proc_SecListSiteGroups** stored procedure returns an integer return code, which MUST be 0, and MUST return one result set.

3.1.5.97.1 **Site Group Information Result Set**

The **Site Group Information Result Set** contains all site group information for the site collection. The **Site Group Information Result Set** MUST be empty if the site collection is not found. Otherwise, 1 row MUST be returned for each site group in the specified site collection. The **Site Group Information Result Set** is defined using T-SQL syntax, in the **Sec_SiteGroupsView** (section [2.2.6.5](#)).

3.1.5.98 **proc_SecListSiteGroupsContainingUser**

The **proc_SecListSiteGroupsContainingUser** stored procedure lists the site groups in which the user is a member (1).

```
PROCEDURE proc_SecListSiteGroupsContainingUser (  
    @SiteId                uniqueidentifier,  
    @UserId                int,  
    @RequestGuid           uniqueidentifier  
);
```

@SiteId: The site collection identifier of the site collection containing the site groups to be listed. This parameter MUST correspond to a valid site collection, and MUST NOT be NULL.

@UserId: The user identifier of the current user. This is used to determine site groups containing this user.

@RequestGuid: The optional request identifier for the current request.

Return Values: The **proc_SecListSiteGroupsContainingUser** stored procedure returns an integer return code which MUST be 0. The **proc_SecListSiteGroupsContainingUser** stored procedure MUST return one result set.

3.1.5.98.1 Site Group Information Result Set

The **Site Group Information Result Set** contains information on site groups where the user is a member (1). The **Site Group Information Result Set** MUST be returned, and MUST contain 1 row for each site group found for the user. The **Site Group Information Result Set** schema is defined in the **Sec_SiteGroupsView** (section [2.2.6.5](#)).

3.1.5.99 proc_SecListSiteGroupsWhichUserOwns

The **proc_SecListSiteGroupsWhichUserOwns** stored procedure returns site group information for the site groups owned by the specified principal.

```
PROCEDURE proc_SecListSiteGroupsWhichUserOwns(  
    @SiteId                uniqueidentifier,  
    @UserId                int,  
    @RequestGuid           uniqueidentifier  
);
```

@SiteId: The site collection identifier of the site collection containing the principal and the site groups to be listed.

@UserId: The user identifier of the principal, used to find the site groups it owns.

@RequestGuid: The optional request identifier for the current request.

Return Values: The **proc_SecListSiteGroupsWhichUserOwns** stored procedure returns an integer return code which MUST be 0, and MUST return one result set.

3.1.5.99.1 Site Group Information Result Set

The **Site Group Information Result Set** returns site group information for all site groups which are owned either directly by the user or external group specified by **@UserId**, or for site groups which are owned indirectly, when the user or external group is a member of a site group which is the returned site group's owner.

The **Site Group Information Result Set** MUST contain one row for each site group owned. The T-SQL syntax for the **Site Group Information Result Set** is defined in the **Sec_SiteGroupsView** (section [2.2.6.5](#)).

3.1.5.100 proc_SecListUsersInRole

The **proc_SecListUsersInRole** stored procedure lists the non-deleted principals assigned to a specified role in the specified scope.

```
PROCEDURE proc_SecListUsersInRole(  
    @SiteId                uniqueidentifier,  
    @ScopeId              uniqueidentifier,  
    @RoleId                int,  
    @RequestGuid           uniqueidentifier  
);
```

@SiteId: The site collection identifier of the site collection containing the scope, role, and principals to be listed.

@ScopeId: The scope identifier of the scope within which to match principals assigned to the role.

@RoleId: Specifies the role identifier of the role definition assigned to the principals to be listed.

@RequestGuid: The optional request identifier for the current request.

Return Values: The **proc_SecListUsersInRole** stored procedure returns an integer return code which MUST be 0, and MUST return one result set.

3.1.5.100.1 User Role Membership Result Set

The **User Role Membership Result Set** returns information about the non-deleted principals assigned to the specified role in the specified scope and site collection. The **User Role Membership Result Set** MUST be empty if no principals assigned to the role are found; otherwise, it MUST include one row of information for each matching principal.

| | |
|-----------------------------|------------------------------|
| <code>tp_Id</code> | <code>int,</code> |
| <code>tp_SystemID</code> | <code>varbinary(512),</code> |
| <code>tp_Title</code> | <code>nvarchar(255),</code> |
| <code>tp_Login</code> | <code>nvarchar(255),</code> |
| <code>tp_Email</code> | <code>nvarchar(255),</code> |
| <code>tp_Notes</code> | <code>nvarchar(1023),</code> |
| <code>tp_SiteAdmin</code> | <code>bit,</code> |
| <code>tp_DomainGroup</code> | <code>bit,</code> |
| <code>tp_Flags</code> | <code>int;</code> |

tp_Id: The user identifier of the principal.

tp_SystemID: The **SystemID** of the principal.

tp_Title: The display name of the principal.

tp_Login: The login name of the principal.

tp_Email: The email address of the principal.

tp_Notes: Contains notes about the principal.

tp_SiteAdmin: If the parameter is set to 1, then the principal is a site collection administrator. If the parameter is set to 0, then the principal is not a site collection administrator.

tp_DomainGroup: If the parameter is set to 1, the principal is a domain group. If the parameter is set to 0, the principal is not a domain group.

tp_Flags: The user information flags value of the principal.

3.1.5.101 proc_SecMigrateUser

The **proc_SecMigrateUser** stored procedure updates the SystemID and login name for a principal in the **UserInfo** (section [2.2.6.10](#)) and **AllUserData** (section [2.2.6.2](#)) Tables. If an existing principal is found with the new login name and **SystemID**, then **proc_SecMigrateUser** MUST update that principal with a new unique **SystemID** and mark that principal as deleted in the **UserInfo** table before updating the specified principal. If an existing principal is found with the new login name and **SystemId**, then **proc_SecMigrateUser** MUST also mark that principal as deleted in the **AllUserData** table's user list.

```

PROCEDURE proc_SecMigrateUser (
    @SiteId                uniqueidentifier,
    @OldLogin              nvarchar(255),
    @NewLogin              nvarchar(255),
    @NewSystemId          varbinary(512),
    @IsWindowsAuth        bit,
    @PeopleListId         uniqueidentifier,
    @LoginColumnName      nvarchar(64),
    @DeletedColumnName    nvarchar(64),
    @OldSystemId          varbinary(512) = NULL,
    @RequestGuid          uniqueidentifier = NULL OUTPUT
);

```

@SiteId: The site collection identifier of the site collection containing the principal to be updated.

@OldLogin: The current value of the principal's login name.

@NewLogin: The new value to set as the principal's login name. This parameter **MUST NOT** be NULL.

@NewSystemId: The new **SystemID** to set for the principal. This parameter **MUST NOT** be NULL.

@IsWindowsAuth: A bit specifying whether the principal is authenticated with Windows-integrated authentication. If this parameter is set to 1 or NULL, then the principal is authenticated using Windows-integrated authentication.

@PeopleListId: The list identifier of the user list.

@LoginColumnName: The name of the column in the **AllUserData** table that stores the user list's login names.

@DeletedColumnName: The name of the column in the **AllUserData** table that marks whether a principal in the user list has been deleted.

@OldSystemId: The current value of the principal's **SystemID**. This parameter can be NULL. If the **@OldSystemId** parameter is not NULL, then the principal specified by **@OldLogin** **MUST** also have the **SystemID** specified by **@OldSystemId**.

@RequestGuid: The optional request identifier for the current request.

Return Values: The **proc_SecMigrateUser** stored procedure returns an integer return code which **MUST** be listed in the following table.

| Value | Description |
|-------|---|
| 0 | Successful execution. |
| 1003 | An existing principal was found with the new login name and SystemID , but proc_SecMigrateUser failed to update it with a new SystemID and mark it as deleted. Failed to find or update the specified principal. |

The **proc_SecMigrateUser** stored procedure **MUST** return no result sets.

3.1.5.102 proc_SecReCalculateWebFGP

The **proc_SecReCalculateWebFGP** stored procedure is invoked to update the bit at 0x00000400 of the **Site Property Flags** (section [2.2.2.11](#)) to indicate whether the site has at least one uniquely

secured object within it. This bit can be used by a search tool to determine whether it avoids indexing pages in this site so as not to reveal secure information.

```
PROCEDURE proc_SecReCalculateWebFGP(  
    @SiteId                uniqueidentifier,  
    @WebId                 uniqueidentifier,  
    @RequestGuid           uniqueidentifier  
);
```

@SiteId: The site collection identifier of the site collection containing the site to be updated. This parameter MUST correspond to a valid site collection, and MUST NOT be NULL.

@WebId: The site identifier of the site containing the flag to be updated.

@RequestGuid: The optional request identifier for the current request.

Return Values: The **proc_SecReCalculateWebFGP** stored procedure returns an integer return code, which MUST be 0, and it MUST return zero result sets.

3.1.5.103 proc_SecRefreshToken

The **proc_SecRefreshToken** stored procedure is invoked to update the **UserInfo Table** (section [2.2.6.10](#)) with information about a specified user's membership in external groups.

```
PROCEDURE proc_SecRefreshToken(  
    @SiteId                uniqueidentifier,  
    @UserId                int,  
    @ExternalToken         varbinary(max),  
    @ExternalTokenTime    datetime,  
    @RequestGuid           uniqueidentifier  
);
```

@SiteId: The site collection identifier of the site collection containing the user to update in the **UserInfo Table** (section [2.2.6.10](#)).

@UserId: The user identifier of the user.

@ExternalToken: An **External Group Token** (section [2.2.3.2](#)) containing external group membership information for the user. This value can be NULL, specifying that the user is not a member of any external groups. **proc_SecRefreshToken** MUST update the **UserInfo Table** row matching the user identifier with this value in the **tp_ExternalToken** field if the table row value in **tp_ExternalTokenLastUpdated** is not greater than the value of **@ExternalTokenTime**.

@ExternalTokenTime: A datetime in UTC specifying when the **External Group Token** in the **@ExternalToken** parameter was last updated. This parameter MUST be NULL if the **@ExternalToken** parameter is NULL. **proc_SecRefreshToken** MUST update the **UserInfo Table** row matching the user identifier with this value in the **tp_ExternalTokenLastUpdated** field if the table row value in **tp_ExternalTokenLastUpdated** is not greater than the value of **@ExternalTokenTime**.

@RequestGuid: The optional request identifier for the current request.

Return Values: The **proc_SecRefreshToken** stored procedure returns an integer return code, which MUST be 0, and it MUST NOT return a result set.

3.1.5.104 proc_SecRemoveGroup

The **proc_SecRemoveGroup** stored procedure is invoked to remove a site group from a site collection.

```
PROCEDURE proc_SecRemoveGroup (
    @SiteId                uniqueidentifier,
    @GroupId                int,
    @UserID                int,
    @AppPrincipalId        int,
    @SiteAdmin              bit,
    @GroupOwnerId           int,
    @CurrentUserIsOwner     bit,
    @ReturnDLAlias          bit,
    @CheckIfInUse           bit,
    @RequestGuid            uniqueidentifier = NULL OUTPUT
);
```

@SiteId: The site collection identifier of the site collection containing the site group to be removed.

@GroupId: The site group identifier for the site group to be removed.

@UserID: The user identifier for the current user. The ownership of any site group previously owned by the deleted site group **MUST** be re-assigned to this user identifier.

@AppPrincipalId: The app principal identifier of the app (1) that is requesting this operation. If the operation was not requested by an app (1) then it **MUST** be set to 0.

@SiteAdmin: A bit flag specifying whether the current user is a site collection administrator. If this flag is set to 1, then the site group **MUST** be removed. If this flag is set to 0, then the site group **MUST NOT** be removed unless **@CurrentUserIsOwner** specifies it.

@GroupOwnerId: The User Identifier or Site Group Identifier of the site group owner. If **@CurrentUserIsOwner** is set to 1, then this value **MUST** be set to the User Identifier of the current user, or a site group which includes the current user. If **@CurrentUserIsOwner** is set to 0, then this value **MUST** be ignored.

@CurrentUserIsOwner: A bit flag specifying that the current user is an owner of the site group. If **@CurrentUserIsOwner** is set to 1 and **@GroupOwnerId** contains the User Identifier of the owner of the site group, or the Site Group Identifier of a site group, which includes the current user, then the site group **MUST** be removed. If **@CurrentUserIsOwner** is set to 0, then the site group **MUST NOT** be removed unless **@SiteAdmin** specifies it.

@ReturnDLAlias: A bit flag specifying whether to return the **DLAlias Result Set**. If this flag is set to 1, the result set **MUST** be returned. If this flag is set to 0, then the result **MUST** not be returned.

@CheckIfInUse: A bit flag specifying whether to check if the site group is in use before removing it. A site group is in use if it is assigned to any role in the site collection. If the site group is not in use, it is removed. If the site group is in use, then it **MUST** not be removed, but the stored procedure **MUST** return an empty **DLAlias Result Set** if **@ReturnDLAlias** is 1 and a Return Value of 0.

@RequestGuid: The optional request identifier for the current request.

Return Values: The **proc_SecRemoveGroup** stored procedure returns an integer return code, which **MUST** be listed in the following table.

| Value | Description |
|-------|---|
| 0 | Successful execution. |
| 5 | The current user has insufficient permissions to remove the site group. |

The **proc_SecRemoveGroup** stored procedure returns either zero or one result set. If the site group is successfully removed and *@ReturnDLAlias* is set to 1, then **proc_SecRemoveGroup** MUST return a result set. If the current user does not have sufficient permissions to remove the site group or *@ReturnDLAlias* is set to 0, then **proc_SecRemoveGroup** MUST NOT return a result set.

3.1.5.104.1 DLAlias Result Set

If the site group existed and was removed successfully and if *@ReturnDLAlias* is set to 1, the **DLAlias Result Set** MUST return the email distribution address of the site group in a single row. The **DLAlias Result Set** MUST be empty if the email distribution address was blank.

```
DLAlias          varchar(128);
```

DLAlias: The e-mail distribution address for the site group.

3.1.5.105 proc_SecMarkGroupForWebDelete

The **proc_SecMarkGroupForWebDelete** stored procedure is invoked to mark a site group for later removal from a site collection.

```
PROCEDURE proc_SecMarkGroupForWebDelete (
    @SiteId          uniqueidentifier,
    @GroupId         int,
    @UserID          int,
    @AppPrincipalId int,
    @SiteAdmin       bit,
    @GroupOwnerId    int,
    @CurrentUserIsOwner bit,
    @DeletionWebId   uniqueidentifier,
    @RequestGuid     uniqueidentifier
);
```

@SiteId: The site collection identifier (section [2.2.1.1.9](#)) of the site collection containing the site group to be marked for removal.

@GroupId: The site group identifier for the site group to be marked for removal.

@UserID: The user identifier for the current user.

@AppPrincipalId: The app principal identifier of the app (1) requesting this operation. If the request is not made by an app (1) then it MUST be set to 0.

@SiteAdmin: A bit flag specifying whether the current user is a site collection administrator. If this flag is set to 1, then the site group MUST be marked for removal. If this flag is set to 0, then the site group MUST NOT be marked for removal unless *@CurrentUserIsOwner* specifies it.

@GroupOwnerId: The user identifier or site group identifier of the site group owner. If **@CurrentUserIsOwner** is set to 1, then this value **MUST** be set to the user identifier of the current user, or a site group that includes the current user. If **@CurrentUserIsOwner** is set to 0, then this value **MUST** be ignored.

@CurrentUserIsOwner: A bit flag specifying that the current user is an owner of the site group. If **@CurrentUserIsOwner** is set to 1 and **@GroupOwnerId** contains the user identifier of the owner of the site group, or the site group identifier of a site group that includes the current user, then the site group **MUST** be marked for removal. If **@CurrentUserIsOwner** is set to 0, then the site group **MUST NOT** be marked for removal unless **@SiteAdmin** specifies it.

@DeletionWebId: The site identifier of the site associated with the group.

@RequestGuid: The optional request identifier for the current request.

Return Values: The **proc_SecMarkGroupForWebDelete** stored procedure returns an integer return code, which **MUST** be listed in the following table.

| Value | Description |
|-------|---|
| 0 | Successful execution. |
| 5 | The current user has insufficient permissions to mark the site group for removal. |

The **proc_SecMarkGroupForWebDelete** stored procedure returns either zero or one result set. If the site group is successfully marked for removal, then **proc_SecMarkGroupForWebDelete** **MUST** return a result set. If the current user does not have sufficient permissions to mark the site group for removal, then **proc_SecMarkGroupForWebDelete** **MUST NOT** return a result set.

3.1.5.105.1 DLAlias Result Set

If the site group existed and was marked for removal successfully, the **DLAlias Result Set** **MUST** return the e-mail distribution address of the site group in a single row. **The DLAlias Result Set** **MUST** be empty if the e-mail distribution address was blank.

```
DLAlias          varchar(128);
```

DLAlias: The e-mail distribution address for the site group.

3.1.5.106 proc_SecRemovePrincipalFromScope

The **proc_SecRemovePrincipalFromScope** stored procedure removes a principal from a security role associated with a site in a specified security scope. If no role is specified, or if the role specified is the "Guest" Role, then the principal **MUST** be removed from all roles in the scope, and it **MUST** also be removed from all roles in other specified scopes or subsite contained within the Site.

```
PROCEDURE proc_SecRemovePrincipalFromScope (
    @SiteId          uniqueidentifier,
    @WebId           uniqueidentifier,
    @WebScopeId     uniqueidentifier,
    @ScopeId        uniqueidentifier,
    @RemoveFromCurrentScopeOnly bit,
    @PrincipalId     int,
    @RoleId         int = NULL,
```

```

        @RequestGuid                uniqueidentifier = NULL OUTPUT
    );

```

@SiteId: The Site Collection Identifier of the site collection containing the principal and scope.

@WebId: The Site Identifier of the site containing the principal and scope.

@WebScopeId: The Scope Identifier of the scope which includes the Site. If the Site has unique permissions, then this MUST be the scope of the Site. If **@RoleId** is not NULL and not the Role Identifier of the Guest Role (1073741825), then **@WebScopeId** MUST be ignored. Otherwise, **@WebScopeId** determines additional scopes or Sites from which the principal MUST be removed, as follows.

| Value | Description |
|-------------------------------|---|
| @WebScopeId = @ScopeId | Remove the principal from the specified role or roles within the Site and within all of the Site's subsites which share the same scope. |
| @WebScopeId ≠ @ScopeId | Remove the principal from the specified role or roles in all scopes contained within the Site. |

@ScopeId: The Scope Identifier of the scope in which to remove the principal from the role. See **@WebScopeId** for behavior based on comparison of the **@ScopeId** and **@WebScopeId** parameter values.

@RemoveFromCurrentScopeOnly: The bit flag indicating from which scope the principal will be removed. If this flag is set to 1, then **proc_SecRemovePrincipalFromScope** MUST remove the principal from the current scope only.

@PrincipalId: The User Identifier of the principal to remove.

@RoleId: The Role Identifier of the role to remove the principal from, within the specified scopes. The value in **@RoleId** MUST either correspond to a valid role or be NULL. If this value is NULL, or if **@RoleId** is the Role Identifier of the Guest Role (1073741825), then **proc_SecRemovePrincipalFromScope** MUST remove the principal from all roles in the specified scopes.

@RequestGuid: The optional request identifier for the current request.

Return Values: The **proc_SecRemovePrincipalFromScope** stored procedure returns an integer return code, which MUST be listed in the following table.

| Value | Description |
|-------|--|
| 0 | Successful execution. |
| 3 | The Scope Identifier points to a Scope whose path cannot be found. |

The **proc_SecRemovePrincipalFromScope** stored procedure MUST return a single result set as follows.

3.1.5.106.1 Site Audit Mask Result Set

The **Site Audit Mask Result Set** contains the information about the **Audit Flags** (section [2.2.2.1](#)) associated with the specified Site. The **Site Audit Mask Result Set** MUST be returned and MUST

contain a single row. The **Site Audit Mask Result Set** is defined in the Common Result Sets **Site Audit Mask Result Set** (section [2.2.4.22](#)).

3.1.5.107 proc_SecRemoveRoleDef

The **proc_SecRemoveRoleDef** stored procedure removes a role definition, and any role assignments which use that role definition, from a specified site.

```
PROCEDURE proc_SecRemoveRoleDef (
    @SiteId                uniqueidentifier,
    @WebId                 uniqueidentifier,
    @RoleId                int,
    @RequestGuid           uniqueidentifier = NULL OUTPUT
);
```

@SiteId: The site collection identifier of the site collection containing the role definition to be removed.

@WebId: The site identifier of the site associated with the role definition to be removed.

@RoleId: The identifier of the role definition to be removed.

@RequestGuid: The optional request identifier for the current request.

Return Values: The **proc_SecRemoveRoleDef** stored procedure MUST return an integer return code of 0. The **proc_SecRemoveRoleDef** stored procedure MUST return the following result set.

3.1.5.107.1 Site Audit Mask Result Set

The **Site Audit Mask Result Set** contains information about the **Audit Flags** (section [2.2.2.1](#)) associated with the Site. The **Site Audit Mask Result Set** MUST be returned and MUST contain one row. The **Site Audit Mask Result Set** is defined in the Common Result Sets **Site Audit Mask Result Set** (section [2.2.4.22](#)).

3.1.5.108 proc_SecRemoveUserFromScopeByLogin

The **proc_SecRemoveUserFromScopeByLogin** stored procedure is invoked to remove a user, specified by login name, from a role in a specified security scope. If no role is specified, or if the role specified is the "Guest" Role, then the user will be removed from all roles in the specified scope and will also be removed from other scopes associated with the specified site.

```
PROCEDURE proc_SecRemoveUserFromScopeByLogin (
    @SiteId                uniqueidentifier,
    @WebId                 uniqueidentifier,
    @WebScopeId           uniqueidentifier,
    @ScopeId              uniqueidentifier,
    @RemoveFromCurrentScopeOnly bit,
    @LoginName            nvarchar(255),
    @RoleId                int                = NULL,
    @RequestGuid           uniqueidentifier  = NULL OUTPUT
);
```

@SiteId: The site collection identifier of the site collection containing the user and scope.

@WebId: The site identifier of the site using the role.

@WebScopeId: The Scope Identifier of the scope which includes the site specified by **@WebId**. If **@RoleId** is not NULL and is not the role identifier of the "Guest" Role (1073741825), then **@WebScopeId** MUST be ignored. Otherwise, **@WebScopeId** determines which additional scopes the User MUST be removed from, as follows:

- If **@WebScopeId** is equal to **@ScopeId**, remove the specified User from all scopes associated with all sites sharing the permissions of the site specified by **@WebId**.
- If **@WebScopeId** is not equal to **@ScopeId**, remove the specified user from all scopes associated with the site specified by **@WebId**.

@ScopeId: The scope identifier of the scope in the site collection from which to remove the user. See **@WebScopeId** for conditions of equality between **@ScopeId** and **@WebScopeId**.

@RemoveFromCurrentScopeOnly: The bit flag indicating from which scope the user is removed. If this flag is set to 1, then **proc_SecRemoveUserFromScopeByLogin** MUST remove the user from the current scope only.

@LoginName: The login name of the user.

@RoleId: The role identifier to remove from the specified scopes. **@RoleId** MUST be NULL or correspond to a valid role. If **@RoleId** is NULL, or is the role identifier of the Guest role (1073741825), then **proc_SecRemoveUserFromScopeByLogin** MUST remove the User corresponding to **@LoginName** from all roles.

@RequestGuid: The optional request identifier for the current request.

Return Values: The **proc_SecRemoveUserFromScopeByLogin** stored procedure returns an integer return code, which MUST be in the following table.

| Value | Description |
|-------|---|
| 0 | Successful execution. |
| 1317 | UserId not found for site collection or login name. |

The **proc_SecRemoveUserFromScopeByLogin** stored procedure MUST return a single result set as follows.

3.1.5.108.1 Site Audit Mask Result Set

The **Site Audit Mask Result Set** returns audit information about the Site specified by **@WebId**. The **Site Audit Mask Result Set** MUST be returned, and MUST contain only one row, as defined in the Common Result Sets **Site Audit Mask Result Set** (section [2.2.4.22](#)).

3.1.5.109 proc_SecRemoveUserFromSite

The **proc_SecRemoveUserFromSite** stored procedure is invoked to remove a user from a site collection. If the User owns site groups, then **proc_SecRemoveUserFromSite** will assign site group ownership to the specified new group (2) owner.

```

PROCEDURE proc_SecRemoveUserFromSite(
    @SiteId                uniqueidentifier,
    @NewSiteGroupOwnerId   int,
    @UserId                int,
    @RequestGuid           uniqueidentifier = NULL OUTPUT

```

);

@SiteId: The Site Collection Identifier for the site collection containing the user to be removed.

@NewSiteGroupOwnerId: An identifier for the user who will take over site group ownership from the user being removed. To succeed, this value **MUST** be -1 or a valid User Identifier in the specified site collection, and **@NewSiteGroupOwnerId** **MUST NOT** have the same value as **@UserId**. If the value is -1, or system account (1073741823) or app account (1073741822) then the site collection owner will be the new site group owner.

@UserId: The User Identifier for the user who is being removed. If **@UserId** is the site collection owner or secondary contact, the change will not succeed. To succeed, this value **MUST** be an existing User Identifier for the specified site collection.

@RequestGuid: The optional request identifier for the current request.

Return Values: The **proc_SecRemoveUserFromSite** stored procedure returns an integer return code which **MUST** be included in the following table.

| Value | Description |
|-------|---|
| 0 | 0 is returned whenever the conditions for the alternate return values of 16 and 4335 are not met. |
| 16 | @NewSiteGroupOwnerId equals @UserId . No changes were made. |
| 4335 | @UserId is the site collection owner or secondary contact. No changes were made. |

The **proc_SecRemoveUserFromSite** stored procedure **MUST NOT** return any result sets.

3.1.5.110 proc_SecRemoveUserFromSiteGroup

The **proc_SecRemoveUserFromSiteGroup** stored procedure is invoked to remove a user from a site group in a site collection.

```
PROCEDURE proc_SecRemoveUserFromSiteGroup(  
    @SiteId                uniqueidentifier,  
    @GroupId                int,  
    @UserIDToBeDeleted     int,  
    @UserID                 int,  
    @AppPrincipalId        int,  
    @SiteAdmin              bit,  
    @BelongsToGroup        bit,  
    @GroupOwnerId           int,  
    @CurrentUserIsOwner    bit,  
    @RequestGuid            uniqueidentifier = NULL OUTPUT  
);
```

@SiteId: The site collection identifier (section [2.2.1.1.9](#)) of the site collection that will be queried for the requested site group.

@GroupId: The site group identifier for the site group that the user specified by **@UserIDToBeDeleted** is to be removed from.

@UserIDToBeDeleted: The user identifier for the user to remove from the specified site group. If **@UserId** and **@UserIDToBeDeleted** refer to the same user, and the site group permits users to

remove themselves from site group membership, then the user specified by *@UserIdToBeDeleted* MUST be removed from the group (2).

@UserID: The user identifier for the current user who is removing the user to be deleted from the specified site group. If *@UserId* and *@UserIdToBeDeleted* refer to the same user, and the site group permits site group members (1) to edit membership, then the user specified by *@UserIdToBeDeleted* is removed from the site group.

@AppPrincipalId: The app principal identifier of the app (1) that is requesting this remove operation. If the request is not made by an app (1) then it MUST be set to 0.

@SiteAdmin: A bit flag specifying whether the user specified by *@UserID* is a site collection administrator of the site collection specified by *@SiteId*. If *@SiteAdmin* is set to "1", then **proc_SecRemoveUserFromSiteGroup** MUST remove the user specified by *@UserIDToBeDeleted* from the site group.

@BelongsToGroup: A bit flag specifying whether the user specified by *@UserID* is a member of the site group specified by *@GroupId*. If *@BelongsToGroup* is set to "1" and the site group permits site group members (1) to edit membership, and the current user specified in *@UserID* is a member of the site group, then **proc_SecRemoveUserFromSiteGroup** MUST remove the user specified by *@UserIDToBeDeleted* from the site group.

@GroupOwnerId: The user identifier or site group identifier of the site group owner specified by *@GroupId*. *@GroupOwnerId* MUST be set to the user identifier of the current user, or, if *@CurrentUserIsOwner* is set to "1," to the site group identifier of a site group which includes the current user. If *@CurrentUserIsOwner* is set to "0", then *@GroupOwnerId* MUST be ignored.

@CurrentUserIsOwner: A bit flag specifying that the user specified by *@GroupOwnerId* is an owner of the site group specified by *@GroupId*. If *@CurrentUserIsOwner* is set to "1" and *@GroupOwnerId* contains either the user identifier of the owner of the site group, or the site group identifier of a site group which includes the current user, then **proc_SecRemoveUserFromSiteGroup** MUST remove the user from the site group.

@RequestGuid: The optional request identifier for the current request.

Return Values: The **proc_SecRemoveUserFromSiteGroup** stored procedure returns an integer return code, which MUST be one of the values in the following table.

| Value | Description |
|-------|---|
| 0 | Successful execution. |
| 5 | The current user has insufficient authority to remove the specified user from the site group. |

The **proc_SecRemoveUserFromSiteGroup** stored procedure MUST NOT return any result sets.

3.1.5.111 proc_SecRemoveUserFromSiteGroupByLogin

The **proc_SecRemoveUserFromSiteGroupByLogin** stored procedure is invoked to remove a user identified by login name from a specified site group.

```
PROCEDURE proc_SecRemoveUserFromSiteGroupByLogin(  
    @SiteId                uniqueidentifier,  
    @GroupId                int,  
    @LoginName              nvarchar(255),  
    @UserID                 int,
```

```

@SiteAdmin          bit,
@BelongsToGroup    bit,
@GroupOwnerId      int,
@CurrentUserIsOwner bit,
@RequestGuid       uniqueidentifier = NULL OUTPUT
);

```

@SiteId: The Site Collection Identifier of the site collection containing the site group and the User to be removed.

@GroupId: The identifier of the site group containing the User to be removed.

@LoginName: The login name of the User to be removed from the site group.

@UserID: The User Identifier of the current user.

@SiteAdmin: A bit flag specifying whether the User specified by **@UserID** is a site collection administrator of the site collection specified by **@SiteId**. If **@SiteAdmin** is set to "1", and **@LoginName** specifies an existing user, then **proc_SecRemoveUserFromSiteGroupByLogin** MUST remove the User specified by **@LoginName** from the site group.

@BelongsToGroup: A bit flag specifying whether the User specified by **@UserID** is a member of the site group specified by **@GroupId**. If **@BelongsToGroup** is set to "1" and the site group permits users to manage site group memberships, and the current user specified in **@UserID** is a member of the site group, and **@LoginName** specifies an existing user, then **proc_SecRemoveUserFromSiteGroupByLogin** MUST remove the User specified by **@LoginName** from the site group.

@GroupOwnerId: The User Identifier or Site Group Identifier of the site group owner specified by **@GroupId**. **@GroupOwnerId** MUST be set to the User Identifier of the current user, or, if **@CurrentUserIsOwner** is set to "1," to the Site Group Identifier of a site group which includes the current user. If **@CurrentUserIsOwner** is set to "0", **@GroupOwnerId** MUST be ignored.

@CurrentUserIsOwner: A bit flag specifying that the User specified by **@GroupOwnerId** is an owner of the site group specified by **@GroupId**. If **@CurrentUserIsOwner** is set to "1" and **@GroupOwnerId** contains either the User Identifier of the owner of the site group, or the site group identifier of a site group which includes the current user, and **@LoginName** specifies an existing user, then **proc_SecRemoveUserFromSiteGroupByLogin** MUST remove the User specified by **@LoginName** from the site group.

@RequestGuid: The optional request identifier for the current request.

Return Values: The **proc_SecRemoveUserFromSiteGroupByLogin** stored procedure returns an integer return code, which MUST be included in the following table.

| Value | Description |
|-------|---|
| 0 | Successful execution. |
| 5 | The current user has insufficient permissions to remove the specified User from the site group. |
| 1317 | UserId not found for site collection or login name. |

The **proc_SecRemoveUserFromSiteGroupByLogin** stored procedure MUST NOT return a result set.

3.1.5.112 proc_SecResetItemPerm

The **proc_SecResetItemPerm** stored procedure is invoked to cause a list item to revert its set of permissions so that it inherits permissions from its parent rather than has its own. The previous set of unique permissions for the list item are discarded.

```
PROCEDURE proc_SecResetItemPerm(  
    @SiteId                uniqueidentifier,  
    @WebId                 uniqueidentifier,  
    @OldScopeId            uniqueidentifier,  
    @Url                   nvarchar(260),  
    @DocId                 uniqueidentifier,  
    @NewScopeId            uniqueidentifier = NULL OUTPUT,  
    @RequestGuid           uniqueidentifier = NULL OUTPUT  
);
```

@SiteId: The **Site Collection Identifier** (section [2.2.1.1.9](#)) of the site collection containing the list item.

@WebId: The **Site Identifier** (section [2.2.1.1.11](#)) of the site (2) containing the item.

@OldScopeId: The **Scope Identifier** (section [2.2.1.1.8](#)) of the security scope of the item.

@Url: The store-relative form URL of the item.

@DocId: The document identifier (2) of the document.

@NewScopeId: This is an output parameter, which provides the **Scope Identifier** of the **security scope** of the item. This **MUST** be the **Scope Identifier** of the item's parent container upon successful execution; otherwise, it remains unchanged.

@RequestGuid: The optional request identifier for the current request.

Return Values: The **proc_SecResetItemPerm** stored procedure returns an integer return code which **MUST** be in the following table.

| Value | Description |
|-------|--|
| 0 | Successful execution. |
| 3 | The item specified is not configured to have unique permissions. This value MUST also be returned when the list item is not found at the specified location, or the @OldScopeID does not match the specified list item's security scope. |

Upon successful execution, the **proc_SecResetItemPerm** stored procedure **MUST** return the **Site Audit Mask Result Set** (section [3.1.5.112.1](#)).

3.1.5.112.1 Site Audit Mask Result Set

The **Site Audit Mask Result Set** contains the information about the **Audit Flags** (section [2.2.2.1](#)) associated with the specified Site. It **MUST** contain a single row. The **Site Audit Mask Result Set** is defined using T-SQL syntax, as defined in the Common Result Sets **Site Audit Mask Result Set** (section [2.2.4.22](#)).

3.1.5.113 proc_SecResetWebToDefaultRoleDefinition

The **proc_SecResetWebToDefaultRoleDefinition** stored procedure is invoked to replace existing roles, role assignments, and Permissions for a specified site (2) and its subsites with a default set of role definitions, as specified by input parameters. If the specified site (2) inherits its security permissions, then a new security scope will be made to hold the new security settings.

proc_SecResetWebToDefaultRoleDefinition will fail if the specified site (2) does not exist or if the specified site (2) has a unique role definition.

```
PROCEDURE proc_SecResetWebToDefaultRoleDefinition(
    @SiteId                uniqueidentifier,
    @WebId                 uniqueidentifier,
    @AuthorID              int,
    @AdminsName            nvarchar(255),
    @AdminsDescription     nvarchar(512),
    @AdminsPermMask       bigint,
    @AuthorsName           nvarchar(255),
    @AuthorsDescription    nvarchar(512),
    @AuthorsPermMask      bigint,
    @ContributorsName      nvarchar(255),
    @ContributorsDescription nvarchar(512),
    @ContributorsPermMask  bigint,
    @BrowsersName          nvarchar(255),
    @BrowsersDescription   nvarchar(512),
    @BrowsersPermMask     bigint,
    @GuestsName            nvarchar(255),
    @GuestsDescription     nvarchar(512),
    @GuestsPermMask       bigint,
    @AnonymousPermMask    bigint,
    @ScopeId               uniqueidentifier OUTPUT,
    @RequestGuid           uniqueidentifier = NULL OUTPUT
);
```

@SiteId: The site collection identifier of the site collection.

@WebId: The **Site Identifier** (section [2.2.1.1.11](#)) of the site (2).

@AuthorID: The user identifier of the principal (1) to be assigned to the Administrator Role. This MUST be the user identifier of an existing principal in the site collection.

@AdminsName: The display name for the Administrator Role. This value MUST NOT be NULL.

@AdminsDescription: The description for the Administrator Role.

@AdminsPermMask: The **WSS Rights Mask** (section [2.2.2.15](#)) for the Administrator Role. This value MUST NOT be NULL.

@AuthorsName: The display name for the Web Designer Role. This value MUST NOT be NULL.

@AuthorsDescription: The description for the Web Designer Role.

@AuthorsPermMask: The **WSS Rights Mask** for the Web Designer Role. This value MUST NOT be NULL.

@ContributorsName: The display name for the Contributor Role. This value MUST NOT be NULL.

@ContributorsDescription: The description for the Contributor Role.

@ContributorsPermMask: The **WSS Rights Mask** for the Contributor Role. This value MUST NOT be NULL.

@BrowsersName: The display name for the Reader Role. This value MUST NOT be NULL.

@BrowsersDescription: The description for the Reader Role.

@BrowsersPermMask: The **WSS Rights Mask** for the Reader Role. This value MUST NOT be NULL.

@GuestsName: The display name for the Guest Role. This value MUST NOT be NULL.

@GuestsDescription: The description for the Guest Role.

@GuestsPermMask: The **WSS Rights Mask** for the Guest Role. This value MUST NOT be NULL.

@AnonymousPermMask: A **WSS Rights Mask** which indicates the rights granted to a User that is anonymous, or has no specific rights.

@ScopeId: The scope identifier of the security scope of the updated permissions, returned as an output parameter.

@RequestGuid: The optional request identifier for the current request.

Return Values: The **proc_SecResetWebToDefaultRoleDefinition** stored procedure returns an integer return code which MUST be in the following table.

| Value | Description |
|-------|--|
| 0 | Successful execution. |
| 3 | Site does not exist or Site has a unique role definition associated with it. |

If execution is not successful, then the **proc_SecResetWebToDefaultRoleDefinition** stored procedure MUST return no result sets. Otherwise, **proc_SecResetWebToDefaultRoleDefinition** MUST return the **Site Audit Mask Result Set** (section [3.1.5.113.1](#)), repeated five times.

3.1.5.113.1 Site Audit Mask Result Set

The **Site Audit Mask Result Set** is returned six times upon successful execution. The first is returned after the Administrator Role has been added, the second after the principal specified by **@AuthorId** has been newly assigned to the administrator role and security scope, and then once per additional role that is added.

Each **Site Audit Mask Result Set** contains the **Audit Flags** (section [2.2.2.1](#)) of the Site and MUST hold a single row, and is defined in the Common Result Sets **Site Audit Mask Result Set** (section [2.2.4.22](#)).

3.1.5.114 proc_SecResolvePrincipal

The **proc_SecResolvePrincipal** stored procedure retrieves information about a principal or site group in the specified site collection, given the principal's login name, e-mail address, or display name.

```
PROCEDURE proc_SecResolvePrincipal (  
    @SiteId                uniqueidentifier,  
    @Input                  nvarchar (255),
```

```

        @InputIsEmailOnly          bit,
        @AccountName              nvarchar(255),
        @DLAlias                  nvarchar(128),
        @DLAliasServerAddress     nvarchar(255),
        @SearchScope              int,
        @RequestGuid              uniqueidentifier = NULL OUTPUT
    );

```

@SiteId: The Site Collection Identifier of the site collection.

@Input: The principal's display name, e-mail address, or login name. This parameter is used to find the principal.

@InputIsEmailOnly: Specifies how input parameters are used to find the principal. If this parameter is 0, then matching in the following order:

1. **@Input** to site group display name;
2. **@AccountName** or **@Input** (when **@AccountName** is NULL) as login name;
3. **@Input** as mobile phone number;
4. **@Input** or **@DLAlias** as email address;
5. **@Input** to principal's display name.

For any value of **@InputIsEmailOnly** that is not 0, skip steps 1, 2 and 3.

@AccountName: The principal's login name. If NULL, and **@Input** did not match on display name, then the value of **@Input** will be taken as login name.

@DLAlias: The principal's email alias to search for.

@DLAliasServerAddress: The server portion of an e-mail address. If the principal is a site group whose e-mail address is available, then this is used to construct the full e-mail address in the **{Email}** column in the **Principal Information Result Set** (section [3.1.5.114.1](#)). If this parameter is NULL and the principal is a site group, **{Email}** MUST return NULL.

@SearchScope: A bit mask signifying the scope in which to search for matching principals. This can have one or more flags set. The following bits within **@SearchScope** can be set to 1.

| Value | Description |
|-------|--------------|
| 0x01 | User |
| 0x04 | Domain group |
| 0x08 | Site group |

@RequestGuid: The optional request identifier for the current request.

Return Values: The **proc_SecResolvePrincipal** stored procedure MUST return an integer return code of 0.

If a match for the principal is found, then the **proc_SecResolvePrincipal** stored procedure MUST return the **Principal Information Result Set**. Otherwise, it MUST NOT return a result set.

3.1.5.114.1 Principal Information Result Set

The **Principal Information Result Set** MUST return a single row containing information about the principal which uniquely matches the input parameters.

```
{MatchType}          int,
{PrincipalType}      int,
{Id}                 int,
{Login}              nvarchar(255),
{Email}              nvarchar(255),
{DisplayName}        nvarchar(255);
```

{MatchType}: Designates the type of match found between input variables and a principal in the site group. Values MUST be listed in the following table.

| Value | Description |
|-------|---------------------------------|
| 1 | Matched by login name. |
| 2 | Matched by e-mail address. |
| 4 | Matched by display name. |
| 5 | Matched by mobile phone number. |

{PrincipalType}: Designates the type of the principal. Value MUST be listed in the following table.

| Value | Description |
|-------|---------------|
| 1 | Domain User. |
| 4 | Domain Group. |
| 8 | Site group. |

{Id}: The identifier for the principal. If no match was found then the value is -1.

{Login}: The login name of the principal. This parameter is NULL if no match was found.

{Email}: The e-mail address, for example, *someone@example.com*, of the principal. This parameter is NULL if no match was found, if no e-mail address is available, or if the principal is a site group but *@DLAliasServerAddress* was NULL.

{DisplayName}: The display name of the principal. The value is NULL if no match was found.

3.1.5.115 proc_SecSetSiteGroupProperties

The **proc_SecSetSiteGroupProperties** stored procedure is invoked to update properties of a site (2) group.

```
PROCEDURE proc_SecSetSiteGroupProperties(
    @SiteId          uniqueidentifier,
    @GroupId          int,
    @Title           nvarchar(255),
    @Description      nvarchar(512),
    @OwnerID         int,
```

```

@OwnerIsUser          bit,
@UserID               int,
@SiteAdmin            bit,
@GroupOwnerId         int,
@CurrentUserIsOwner  bit,
@DLAlias              nvarchar(255),
@DLErrorMessage      nvarchar(255),
@DLFlags              int,
@DLJobId              int,
@DLArchives           varchar(4000),
@RequestEmail        nvarchar(255),
@Flags                int,
@RequestGuid          uniqueidentifier = NULL OUTPUT
);

```

@SiteId: The **Site Collection Identifier** (section [2.2.1.1.9](#)) of the site collection containing the site (2) group to update.

@GroupId: The identifier for the site (2) group to update.

@Title: The new user-friendly display name for the site (2) group. If this parameter is NULL, the update **MUST** fail and the return code **MUST** be 80. However, if the user does not have sufficient permissions, the return code **MUST** be five.

@Description: The new description for the site (2) group. This parameter can be NULL.

@OwnerID: The identifier of a user, domain group, or site (2) group to be set as the owner of the site (2) group. This parameter **MUST** contain the identifier of an existing user, domain group, or site (2) group.

@OwnerIsUser: A bit which specifies whether the value in **@OwnerID** is a user or domain group rather than a site (2) group. A value of one specifies that the value in **@OwnerID** is a user or domain group. A value of "0" specifies that the value in **@OwnerID** is a site (2) group identifier.

@UserID: The **User Identifier** (section [2.2.1.1.13](#)) of the current user. This parameter **MUST** be ignored by **proc_SecSetSiteGroupProperties**.

@SiteAdmin: A bit flag specifying whether the current user has site collection administrator permission level. A value of one specifies that the current user has site collection administrator permission level. This parameter is used to check user's permission to change the site (2) group permissions and it can be NULL.

@GroupOwnerId: The **User Identifier** or **Site Group Identifier** (section [2.2.1.1.10](#)) to compare with the existing owner of the site (2) group. Site (2) group management permissions **MUST** be granted if the value in **@GroupOwnerId** matches the identifier of the existing owner of the site (2) group and the value of **@CurrentUserIsOwner** is "1". This parameter is used to check user's permission to change the site (2) group permissions and it can be NULL.

@CurrentUserIsOwner: A bit flag specifying whether the value in **@GroupOwnerId** is to be compared with the owner of the site (2) group. Site (2) group management permissions **MUST** be granted if the value in **@GroupOwnerId** matches the identifier of the existing owner of the site (2) group and the value of **@CurrentUserIsOwner** is "1". This parameter can be NULL. If this parameter is NULL, the update **MUST** fail and the return code **MUST** be 80. However, if the user does not have sufficient permissions, the return code **MUST** be five.

@DLAlias: The new e-mail address for the **distribution list** associated with this site (2) group. This parameter can be NULL.

@DLErrorMessage: The most recent error message returned by an asynchronous email distribution list operation, if any. This parameter can be NULL.

@DLFlags: An integer containing new status flags for the distribution list associated with this group, as defined for the **DLFlags** column in the **Sec_SiteGroupsView** (section [2.2.6.5](#)). This parameter can be NULL.

@DLJobId: Contains the job identifier of a new currently pending asynchronous distribution list (1) operation. A value of zero or NULL specifies there is no pending operation. This parameter can be NULL.

@DLArchives: An array of bytes containing a new list (1) of pairs of site identifiers and list identifiers defining additional lists (1), which are the recipients of e-mail sent to the distribution list via the e-mail address in **@DLAlias**. Each pair **MUST** be stored as a string, with commas separating the list's (1) parent site (2) document identifier (2) and the list identifier, and with semicolons following each pair. This parameter can be NULL (this will overwrite the current value).

@RequestEmail: The new e-mail address used to send a request to join or depart this site (2) group. This parameter can be NULL (this will overwrite the current value).

@Flags: Contains the new membership permissions bit flags for the site (2) group. The bit flags are defined in the description of the **Flags** column of the **Sec_SiteGroupsView** table.

@RequestGuid: The optional request identifier for the current request.

Return Values: The **proc_SecSetSiteGroupProperties** stored procedure **MUST** return an integer return code from the following table.

| Value | Description |
|-------|---|
| 0 | Successful execution. |
| 5 | The current user does not have sufficient permissions to manage the site (2) group, or the site collection is set to read-only. |
| 80 | An update error occurred or a parameter was invalid. |

The **proc_SecSetSiteGroupProperties** stored procedure **MUST NOT** return a result set.

3.1.5.116 **proc_SecSetUserAccountDirectoryPath**

The **proc_SecSetUserAccountDirectoryPath** stored procedure is invoked to set or clear the user account directory path for a specified site collection.

```
PROCEDURE proc_SecGetUserAccountDirectoryPath(  
    @SiteId                uniqueidentifier,  
    @Restriction           nvarchar(512),  
    @RequestGuid          uniqueidentifier = NULL OUTPUT  
);
```

@SiteId: The site collection identifier of the site collection.

@Restriction: Specifies the user account directory path for the specified site collection. If *@Restriction* is not NULL the **proc_SecSetUserAccountDirectoryPath** stored procedure MUST set the user account directory path for the site collection, and also set the 0x00080000 bit of the **Site Collection Flags** to 1. If *@Restriction* is NULL, then the **proc_SecSetUserAccountDirectoryPath** stored procedure MUST set the user account directory path for the site collection to NULL, and also set the 0x00080000 bit of the **Site Collection Flags** to 0.

@RequestGuid: The optional request identifier for the current request.

Return Values: The **proc_SecSetUserAccountDirectoryPath** stored procedure returns an integer which MUST be 0.

The **proc_SecGetUserAccountDirectoryPath** stored procedure MUST NOT return a result set.

3.1.5.117 proc_SecSetWebRequestAccess

The **proc_SecSetWebRequestAccess** stored procedure is invoked to set the request access email address for a specified site. Site access requests to the particular site are routed to the specified request access email address.

```
PROCEDURE proc_SecSetWebRequestAccess (
    @SiteId                uniqueidentifier,
    @WebId                 uniqueidentifier,
    @RequestAccessEmail    nvarchar(255),
    @RequestGuid           uniqueidentifier = NULL OUTPUT
);
```

@SiteId: The site collection identifier of the site collection.

@WebId: The site identifier of the site to set the request access email address.

@RequestAccessEmail: The new request access email address.

@RequestGuid: The optional request identifier for the current request.

Return Values: This procedure MUST return an integer return code of 0, and MUST NOT return a result set.

3.1.5.118 proc_SecUpdateAnonymousPermMask

The **proc_SecUpdateAnonymousPermMask** stored procedure is invoked to modify the permissions for the anonymous user. The site MUST have a unique scope identified by *@ScopeId* rather than an inherited scope. If the scope specified by *@SiteId*, *@WebId*, and *@ScopeId* does not exist, then the change MUST NOT occur.

```
PROCEDURE proc_SecUpdateAnonymousPermMask (
    @SiteId                uniqueidentifier,
    @WebId                 uniqueidentifier,
    @ScopeId               uniqueidentifier,
    @AnonymousPermMask     bigint,
    @RequestGuid           uniqueidentifier = NULL OUTPUT
);
```

@SiteId: The Site Collection Identifier of the site collection containing the scope.

@WebId: The Site Identifier of the site associated with the scope.

@ScopeId: The Scope Identifier of the scope containing the permission set.

@AnonymousPermMask: A WSS Rights Mask (section [2.2.2.15](#)). The scope's permissions for anonymous Users MUST be updated to this value.

@RequestGuid: The optional request identifier for the current request.

Return Values: The **proc_SecUpdateAnonymousPermMask** stored procedure returns an integer return code which MUST be 0.

The **proc_SecUpdateAnonymousPermMask** stored procedure MUST NOT return a result set.

3.1.5.119 proc_SecUpdateDomainGroupMapData

The **proc_SecUpdateDomainGroupMapData** stored procedure is invoked to update the domain group map cache of a specified site collection.

```
PROCEDURE proc_SecUpdateDomainGroupMapData (  
    @SiteId                uniqueidentifier,  
    @CacheVersion          bigint,  
    @DomainGroupMapCache  varbinary(max),  
    @RequestGuid           uniqueidentifier = NULL OUTPUT  
);
```

@SiteId: The Site Collection Identifier of the site collection to update. This parameter MUST correspond to a valid site collection, and MUST NOT be NULL.

@CacheVersion: A signed 64-bit (8-byte) integer containing the cache version number. This value is derived from the value of the SecurityVersion field contained in the site collection Access Control List (ACL). See the **WSS ACL** (section [2.2.3.6](#)). This parameter MUST NOT be NULL.

@DomainGroupMapCache: The domain group map value is defined in the **WSS External Group Map Cache Format** (section [2.2.3.7](#)).

| Value | Bytes | Description |
|---------------|------------|---|
| CachedVersion | 8 | The current cached security version. This is the same value as <i>@CacheVersion</i> . |
| DGCount | 4 | Count of Domain Groups. |
| REPEAT | | Repeat the following fields "DGCount" times. |
| DGSigSize | 4 | Size of the domain group signature, in bytes. |
| DGSig | DGSigSize | Value of the domain group signature. |
| PIDCount | 4 | Count of PIDs (principal IDs) in this domain group. |
| PIDs | 4*PIDCount | The value of each PID. |

@RequestGuid: The optional request identifier for the current request.

Return Values: The **proc_SecUpdateDomainGroupMapData** stored procedure MUST return an integer return code of 0.

The **proc_SecUpdateDomainGroupMapData** stored procedure MUST NOT return a result set.

3.1.5.120 proc_SecUpdateRoleDef

The **proc_SecUpdateRoleDef** stored procedure is invoked to update a role definition with a new title, description, display order, **Role Definition Type** (section [2.2.1.2.16](#)), and **WSS Rights Mask** (section [2.2.2.15](#)).

```
PROCEDURE proc_SecUpdateRoleDef (
    @SiteId                uniqueidentifier,
    @WebId                 uniqueidentifier,
    @RoleId                int,
    @Title                 nvarchar(255),
    @Description           nvarchar(512),
    @Order                 int,
    @Type                  tinyint,
    @PermMask              bigint,
    @RequestGuid           uniqueidentifier = NULL OUTPUT
);
```

@SiteId: The site collection identifier of the site collection containing the role definition to be updated.

@WebId: The site identifier of the site containing the role definition to be updated.

@RoleId: The role identifier of the role definition to be updated.

@Title: The title of the role definition for display in the front-end Web server. This MUST be a value that does not match an existing role definition title within the site, and MUST NOT be NULL.

@Description: The description of the role definition for display in the front-end Web server.

@Order: An integer value specifying the relative position in which this role definition is displayed in the front-end Web server. Multiple role definitions can have the same **@Order** value. This value MUST NOT be NULL.

@Type: The **Role Definition Type** value for the updated role.

@PermMask: A **WSS Rights Mask** that specifies the rights to grant to the role definition. If this field is not NULL, then the **WSS Rights Mask** associated with the role definition MUST be set to this value and any permissions associated with this role definition in the site and site collection MUST be modified. If this field is NULL, then the existing **WSS Rights Mask** associated with the role definition MUST NOT be changed.

@RequestGuid: The optional request identifier for the current request.

Return Values: The **proc_SecUpdateRoleDef** stored procedure returns an integer return code which MUST be in the following table.

| Value | Description |
|-------|---|
| 0 | Successful execution. |
| 80 | The role definition could not be updated. |

Upon successful execution, the **proc_SecUpdateRoleDef** stored procedure MUST return a single result set as follows.

3.1.5.120.1 Site Audit Mask Result Set

The **Site Audit Mask Result Set** contains information about the **Audit Flags** (section [2.2.2.1](#)) associated with the site. If execution is successful, then the **Site Audit Mask Result Set** MUST be returned, and MUST contain one row. The **Site Audit Mask Result Set** is defined in the Common Result Sets **Site Audit Mask Result Set** (section [2.2.4.22](#)).

3.1.5.121 proc_SecUpdateUser

The **proc_SecUpdateUser** stored procedure is invoked to update the display name, e-mail address, notes, or administrative privileges listed in the user information associated with a principal.

```
PROCEDURE proc_SecUpdateUser(
    @SiteId                uniqueidentifier,
    @CurrentUserId         int,
    @AppPrincipalId       int,
    @UserIdToUpdate       int,
    @Title                 nvarchar(255),
    @Email                 nvarchar(255),
    @Notes                 nvarchar(1023),
    @SiteAdmin             bit,
    @Flags                 int,
    @RequestGuid           uniqueidentifier = NULL OUTPUT
);
```

@SiteId: The site collection identifier of the site collection containing both the current user and the principal to be updated.

@CurrentUserId: The user identifier of the current user making the update request.

@AppPrincipalId: The app principal identifier of the app (1) making the update request. If the request is not made by an app (1) then this MUST be 0.

@UserIdToUpdate: The user identifier of the principal whose user information is to be updated.

@Title: The display name to be set in the principal's user information. If this parameter is NULL, then the user information update MUST fail.

@Email: The e-mail address to be set in the principal's user information. If this parameter is NULL, then the user information update MUST fail.

@Notes: The notes text to be set in the principal's user information. If this parameter is NULL, then the user information update MUST fail.

@SiteAdmin: A bit specifying whether or not to set the principal as a site collection administrator.

- When this parameter is set to "1", if the current user is a site collection administrator, and the principal is not a domain group, then the principal MUST be set as a site collection administrator.
- When this parameter is set to "0", **proc_SecUpdateUser** MUST clear the site collection administrator flag in the user information for the principal.

- If this parameter is NULL, then **proc_SecUpdateUser** MUST make no changes to the site collection administrator flag.

@Flags: A flag specifying the user information flags (section [2.2.2.12](#)) to be set in the principal's user information.

- If the current user is NOT a site collection administrator, then the value MUST be NULL.
- If the parameter is NULL, then **proc_SecUpdateUser** MUST make no changes to the site collection administrator flag.

@RequestGuid: The optional request identifier for the current request.

Return Values: The **proc_SecUpdateUser** stored procedure returns an integer return code which MUST be in the following table.

| Value | Description |
|-------|---|
| 0 | Successful execution. |
| 4335 | Cannot successfully remove the site collection administrator privilege from the principal, as no other site collection administrator was found. |

Result Sets: The **proc_SecUpdateUser** stored procedure MUST NOT return a result set.

3.1.5.122 proc_SecUpdateUserActiveStatus

The **proc_SecUpdateUserActiveStatus** stored procedure marks a user as an active user in a site collection.

```
PROCEDURE proc_SecUpdateUserActiveStatus(
    @SiteId                uniqueidentifier,
    @UserId                int,
    @RequestGuid           uniqueidentifier = NULL OUTPUT
);
```

@SiteId: The site collection identifier of the site collection containing the user.

@UserId: The user identifier for the user to be marked as active user. If the user is not found or if the user is the system account, then **proc_SecUpdateUserActiveStatus** MUST take no action.

@RequestGuid: The optional request identifier for the current request.

Return Values: The **proc_SecUpdateUserActiveStatus** stored procedure returns an integer return code which MUST be 0.

The **proc_SecUpdateUserActiveStatus** stored procedure MUST return no result sets.

3.1.5.123 proc_TakeOverCheckOut

The **proc_TakeOverCheckOut** stored procedure is invoked to override checkout for a document that is checked out and has no checked-in draft or published version.

```
PROCEDURE proc_TakeOverCheckOut(
    @SiteId                uniqueidentifier,
    @ListId                uniqueidentifier,
```

```

@DirName          nvarchar(256),
@LeafName         nvarchar(128),
@UserId          int,
@RequestGuid     uniqueidentifier = NULL OUTPUT
);

```

@SiteId: The Site Collection Identifier of the site collection containing the document.

@ListId: The List Identifier of the list containing the document.

@DirName: The directory name of the document.

@LeafName: The leaf name of the document.

@UserId: The User Identifier for the current user. This value **MUST** refer to an existing User Identifier for the specified site collection.

@RequestGuid: The optional request identifier for the current request.

Return Values: The **proc_TakeOverCheckOut** stored procedure returns an integer return code, which **MUST** be listed in the following table.

| Value | Description |
|-------|---|
| 0 | Successful execution, or the User specified by <i>@UserId</i> does not exist, or specified document is already checked out to the specified User. |
| 2 | File Not Found: The specified document was not found; or the document is not checked out; or the document is checked out, but another current version of the document exists. |

The **proc_TakeOverCheckOut** stored procedure **MUST NOT** return any result sets.

3.1.5.124 proc_UncheckoutDocument

The **proc_UncheckoutDocument** stored procedure is invoked to release a checked out document. The current document is set to the most recent previous published or draft version, or to the version currently checked out, depending on the document state and the **proc_UncheckoutDocument** parameters.

```

PROCEDURE proc_UncheckoutDocument (
@SiteId          uniqueidentifier,
@WebId          uniqueidentifier,
@DirName        nvarchar(256),
@LeafName       nvarchar(128),
@UserId        int,
@ForceUncheckout bit,
@RequestGuid    uniqueidentifier = NULL OUTPUT
);

```

@SiteId: The Site Collection Identifier of the site collection containing the document to have its short-term lock released or its check out reverted.

@WebId: The Site Identifier of the site containing the document.

@DirName: The Document's directory name.

@LeafName: The Document's leaf name.

@UserId: The user identifier of the current user.

@ForceUncheckout: Specifies whether to force the reversion of a check out of the document held by another User. If this parameter is set to "1", then the checkout of the document MUST be released, and the most recent previous draft or published version MUST be reverted to the current version, even if the current user is not the user the document is checked out to. The owner of the checkout can also force the reversion of a checkout. If **@ForceUncheckout** is not set to "1", then the checkout of the document will not be released, and the most recent previous draft or published version will not revert to the current version if the current user is not the user the document is checked out to.

@RequestGuid: The optional request identifier for the current request.

Return Values: The **proc_UncheckoutDocument** stored procedure returns an integer return code which MUST be listed in the following table.

| Value | Description |
|-------|---|
| 0 | Successful execution. |
| 3 | The document was not found at the specified location. |
| 33 | The document is long-term checked out by another user. |
| 158 | The document is not checked out, or does not have a short-term lock, or the current user attempted to release a short-term lock on a document that is checked out, or to revert the check out of a document that has a short-term lock. |
| 167 | The document is long-term checked out and the current user attempted to release a short-term lock. |
| 173 | Another User has checked out the document or has a short-term lock on the document, and @Force is not set to "1". |
| 2401 | A checked-out document was specified and no published or draft version of the document exists to revert to. |
| 6002 | The current user attempted to release a shared-lock. |
| 6009 | The current user attempted to release a lock, but the file is short-term locked by someone else. |

proc_UncheckoutDocument MUST return 2 or 3 result sets in the order specified in the following sections.

3.1.5.124.1 Link Info Result Set

The **Link Info Result Set** returns information about all forward links and backward links associated with the document. The **Link Info Result Set** MUST be returned and MUST contain one row for each forward link and backward link associated with the specified document after the short-term lock has been released or the checkout has been reverted.

The **Link Info Result Set** is defined in the Common Result Sets **Link Information Result Set** (section [2.2.4.13](#)).

3.1.5.124.2 Document Metadata Result Set

The **Document Metadata Result Set** returns the metadata for the specified document after the short-term lock has been released or the checkout has been reverted. The **Document Metadata Result Set** MUST be returned and MUST contain one row for the specified document.

The **Document Metadata Result Set** is defined in the Common Result Sets **Document Metadata Result Set** (section [2.2.4.8](#)).

3.1.5.124.3 NULL Result Set

The **NULL Result Set** returns no data. The **NULL Result Set** MUST only be returned if the **Document Metadata Result Set** is not empty and *@WebId* is NULL. The **NULL Result Set** MUST return zero rows in a schema containing a single NULL column.

3.1.5.124.4 Event Receivers Result Set

The **Event Receivers Result Set** contains information about the list item event receivers defined for this document.

The **Event Receivers Result Set** MUST only be returned if the **Document Metadata Result Set** is not empty and *@WebId* is not NULL. There MUST be one row for each event receiver with an **Event Host Type** (section [2.2.1.2.5](#)) of 3 (list item) registered for the specified document after the short-term lock has been released or the checkout has been reverted.

The **Event Receivers Result Set** is defined in the Common Result Sets **Event Receivers Result Set** (section [2.2.4.11](#)).

3.1.5.125 proc_UpdateDocBuildDependencySet

The **proc_UpdateDocBuildDependencySet** stored procedure is invoked to store an updated version of a build dependency set for a specified document.

```
PROCEDURE [proc_UpdateDocBuildDependencySet] (  
    @DocSiteId                uniqueidentifier,  
    @DocDirName               nvarchar(256),  
    @DocLeafName              varchar(128),  
    @Level                    tinyint,  
    @BuildDependencySet       varbinary(max),  
    @RequestGuid              uniqueidentifier = NULL OUTPUT  
);
```

@DocSiteID: The Site Collection Identifier of the site collection containing the document.

@DocDirName: The directory name of the document.

@DocLeafName: The leaf name of the document.

@Level: The **Publishing Level Type** value of the document containing the dependency set to update.

@BuildDependencySet: The build dependency set for the document. This parameter MUST NOT be NULL. Use **proc_DeleteDocBuildDependencySet** to set the document dependencies to NULL.

@RequestGuid: The optional request identifier for the current request

Return Values: The **proc_UpdateDocBuildDependencySet** stored procedure MUST return an integer return code of 0.

The **proc_UpdateDocBuildDependencySet** stored procedure MUST NOT return a result set.

3.1.5.126 **proc_UpdateDocument**

The **proc_UpdateDocument** stored procedure is invoked to update the metadata and stream (1) of a document.

```
PROCEDURE proc_UpdateDocument (
    @DocSiteId                uniqueidentifier,
    @DocWebId                 uniqueidentifier,
    @DocDirName               nvarchar(256),
    @DocLeafName              nvarchar(128),
    @SendingContent           bit,
    @DocMetaInfo              varbinary(max),
    @DocSize                  int,
    @DocMetaInfoSize          int,
    @DocFileFormatMetaInfo    varbinary(max),
    @DocFileFormatMetaInfoSize int,
    @DocDirty                 bit,
    @DocVersion               int,
    @DocMetaInfoVersion       int,
    @DocFlags                 int,
    @DocIncomingCreatedDTM    datetime,
    @DocIncomingDTM           datetime,
    @ThicketMainFile          bit,
    @GetWebListForNormalization bit,
    @VersioningEnabled         bit,
    @EnableMinorVersions       bit,
    @UserId                   int,
    @AttachmentOp             int,
    @PutFlags                 int,
    @UpdateFlags              int,
    @CharSet                  int,
    @ProgId                   nvarchar(255),
    @AuditMask                bit,
    @WebParts                 bit,
    @Comment                  nvarchar(1023),
    @IsModerate               bit,
    @NeedsDraftOwnerRestriction bit,
    @WelcomePageUrl           nvarchar(260),
    @WelcomePageParameters    nvarchar(max),
    @VirusVendorID            int,
    @VirusStatus              int,
    @VirusInfo                nvarchar(255),
    @VirusInfoEx              varbinary(max),
    @LockTimeout              int,
    @RefreshLock              bit,
    @SharedLock               bit,
    @FileFragmentPartitionToCheck tinyint,
    @FileFragmentIdToCheck    bigint,
    @FileFragmentPartitionsToDelete nvarchar(max),
    @PartitionsToDelete       nvarchar(max),
    @DocContentVerBump         int,
    @NextBSNCheck             bigint,
    @BSNBump                  bigint,
```



```

@StreamSchema          tinyint,
@DocId                 uniqueidentifier      OUTPUT,
@Level                 tinyint              OUTPUT,
@DoclibRowId           int                  OUTPUT,
@DocDTM                datetime            OUTPUT,
@DocUIVersion          int                  OUTPUT,
@DocFlagsOut           int                  OUTPUT,
@DocVersionOut         int                  OUTPUT,
@RequestGuid           uniqueidentifier = NULL OUTPUT
);

```

@DocSiteId: The site collection identifier for the site collection containing the document to be updated.

@DocWebId: The site identifier for the site (2) containing the document.

@DocDirName: The directory name of the document location.

@DocLeafName: The leaf name of the document location.

@SendingContent: Specifies whether or not to store the document stream in the back-end database server. This attribute **MUST** be one if the document stream of the document is intended to be stored in the back-end database server; otherwise, it **MUST** be zero.

@DocMetaInfo: The metadata information for the document to be stored. If there is no metadata information for this document, this parameter **MUST** be NULL.

@DocSize: Final size in bytes of the document stream of the document. This **MUST** be zero if **@SendingContent** is zero.

@DocMetaInfoSize: Size in bytes of the document's metadata. This **MUST** be zero if **@DocMetaInfo** is NULL.

@DocFileFormatMetaInfo: The file format metadata stream (1) for the document.

@DocFileFormatMetaInfoSize: Size in bytes of the document's file format metadata.

@DocDirty: A bit flag specifying whether the document has dependencies, such as links to other items, which need to be updated. If this parameter is set to "1", the document has dependencies to be updated. This flag **MUST** be stored by the back-end database server for subsequent updating of the dependent information.

@DocVersion: The internal version number of the document content to check on update. If this value is NULL, or the current internal version number value is NULL, or this value does not equal the current internal version number value of the document content, the entire document **MUST NOT** be updated. If the current internal version number value is NULL or **@PutFlags** contains 0x00800000 (from **Put Flags Type** (section [2.2.2.7](#))), the current internal version number **MUST NOT** be incremented. Otherwise, it **MUST** be incremented by an implementation-specific amount.

@DocMetaInfoVersion: The internal version number of the document metadata to check on update. If this value is NULL or does not equal the current internal version number value of the document metadata, the entire document **MUST NOT** be updated. If the document was updated, this value **MUST** be incremented by an implementation-specific amount.

@DocFlags: A **document flag** value with metadata describing the document to be updated.

@DocIncomingCreatedDTM: The datetime in UTC of the creation time stamp of the document. If this value is null, the current creation date of the document **MUST NOT** be updated.

@DocIncomingDTM: The datetime in UTC of the current modification time stamp of the document. If this value is null, the current last modification time stamp of the document **MUST** be set to the current UTC datetime of the back-end database server.

@ThicketMainFile: Specifies whether the document is a thicket main file. If this parameter is set to "1", the document is a thicket main file. If this parameter is set to "0", the document is not a thicket main file or a thicket supporting file. If this parameter is NULL, this document is a thicket supporting file.

@GetWebListForNormalization: If this parameter is set to "1", upon successful completion the procedure **MUST** return list (1) of sites (2) in a **Site List For Normalization Result Set** (section [3.1.5.126.1](#)) whose immediate parent site is the site (2) containing the document to be updated.

@VersioningEnabled: A bit flag specifying whether historical versioning is enabled for the list (1) that contains this document. If this parameter is set to "0", a new historical version **MUST NOT** be created as part of this update. This parameter **MUST** be ignored for uncustomized items and documents that are not list items or in a document library.

@EnableMinorVersions: Specifies whether minor versions are enabled on the document. If this parameter is set to "1", minor versions **MUST** be enabled; otherwise, minor versions **MUST NOT** be enabled. This parameter **MUST** be ignored for uncustomized items and documents that are not list items or in a document library.

@UserId: The user identifier of the current user that is making the request to the front-end Web server.

@AttachmentOp: An integer containing **Attachments Flags** (section [2.2.1.2.1](#)) describing the document.

@PutFlags: A **Put Flags Type** value that specifies document update options.

@UpdateFlags: A bit field that tracks additional document change options. If this parameter is "1", links that are no longer applicable after the document is updated **MUST** be deleted. If this parameter is not "1", it **MUST** be ignored.

@CharSet: An identifier for the code page to associate with the document. If this value is NULL, there **MUST** be no code page associated with the document.

@ProgId: Specifies a preferred application to open this document. The **ProgId** is used to distinguish among different applications that save files with a given file extension (for example, different editors for HTML or XML files). If this value IS NULL, there **MUST** be no preferred application for this document.

@AuditMask: A bit flag specifying whether to return the current **Audit Flags** (section [2.2.2.1](#)) values for the document. If this parameter is set to "1", the **Site Audit Mask Result Set** (section [3.1.5.126.2](#)) **MUST** be returned on successful completion.

@WebParts: A bit flag specifying whether or not the update to the document includes updates to Web Parts. If this parameter is set to "1", any links to Web Parts contained inside the document **MUST** be removed from the back-end database server.

@Comment: A description provided when a document is checked in or published, which could be displayed by a version management UI. This value **MUST** be updated for the document even if it is not currently checked out.

@IsModerate: A bit flag specifying whether moderation is in effect for this document. If this parameter is set to "1", moderation is in effect on this document and moderation rules **MUST** be applied to prevent document publication and to implement an approval process when the document is updated.

@NeedsDraftOwnerRestriction: A bit flag specifying whether or not the draft owner for this document is the only user allowed to update it. If this parameter is set to "1" and a draft owner exists for the document, the document **MUST** only be updated if **@UserId** is the draft owner.

@WelcomePageUrl: Specifies a welcome page to redirect to when the document is fetched. If this value is NULL, there **MUST** be no redirection.

@WelcomePageParameters: Specifies query string or bookmark parameters, if any, to append to the **URI** specified by **@WelcomePageUrl**. If this value is NULL, there **MUST** be no parameters added.

@VirusVendorID: If provided, specifies the vendor identifier of the virus scanner that processed this document.

@VirusStatus: A **Virus Status** value (section [2.2.1.2.17](#)) specifying the current virus check status of this document.

@VirusInfo: A string containing a provider-specific message returned by the virus scanner when it last processed the document. This value **MUST** be NULL, if the document does not exist or if the document has not been processed by a virus scanner.

@VirusInfoEx: A binary value that specifies extensible virus information for this document, which is opaque to the back-end server.

@LockTimeout: An integer value specifying the number of minutes a short-term lock is to be maintained for the document. A value of zero means the short-term lock **MUST** be released immediately. This value **MUST** be NULL if no short-term lock is being applied, refreshed, or released on the document.

@RefreshLock: Specifies whether to refresh a short-term lock on the document. If **@LockTimeout** is NULL, this parameter **MUST** be ignored.

- If this parameter is set to "1", the existing short-term lock on the document **MUST** be set to remain for the number of minutes specified by **@LockTimeout**.
- If this parameter is "0", the time remaining for an existing short-term lock on the document **MUST** remain unchanged.
- If there is no short-term lock on the document, this parameter **MUST** be NULL.

@SharedLock: Specifies whether the short-term lock to obtain, refresh, or release is of type shared or exclusive. If this parameter is "1", the lock type **MUST** be shared. Otherwise, the lock type **MUST** be exclusive. If **@LockTimeout** is NULL, this parameter **MUST** be ignored.

@FileFragmentPartitionToCheck: Specifies the implementation-specific file fragment partition identifier used with **@FileFragmentIdToCheck**.

@FileFragmentIdToCheck: Specifies the implementation-specific file fragment identifier to use for checking the implementation-specific file fragments, along with **@FileFragmentPartitionToCheck**. If **@FileFragmentPartitionToCheck** or **@FileFragmentIdToCheck** is NULL or the largest implementation-specific file fragment identifier in the partition specified by **@FileFragmentPartitionToCheck** is equal to **@FileFragmentIdToCheck**, the document **MUST** be updated and the current internal version number **MUST** be incremented. Otherwise it **MUST NOT** be incremented.

@FileFragmentPartitionsToDelete: A string of comma-separated integers that specifies which implementation-specific file fragment partition identifier to delete. If *@SystemUpdate* is one or *@SendingContent* is zero or *@VirusStatus* is not NULL and not three, this parameter MUST be ignored. Otherwise, the implementation-specific file fragment in those partitions MUST be deleted. The format MUST be as follows for file-fragment-partition-list.

```
file-fragment-partition-list = *file-fragment-partition *("," file-fragment-partition)
file-fragment-partition = *DIGIT
```

@PartitionsToDelete: A string of comma-separated integers that specifies which stream partition has all of its stream binary pieces deleted. If *@SystemUpdate* is one or *@SendingContent* is zero or *@VirusStatus* is not NULL and not three, this parameter MUST be ignored. Otherwise, the stream binary piece specified by the stream partitions MUST be deleted. The format MUST be the same as file-fragment-partition-list.

@DocContentVerBump: An integer value used to increase the version of the content stored in the back-end database server. This value is added to the current content version number only if *@SendingContent* is set to one. If *@SendingContent* is set to zero, this parameter MUST be ignored.

@NextBSNCheck: Specifies the current BLOB sequence number to check for the document. If this parameter is NULL or the current BLOB sequence number of the document is equal to *@NextBSNCheck*, the document MUST be updated and the current internal version number MUST be incremented. Otherwise, the current internal version number MUST NOT be incremented.

@BSNBump: Specifies the amount to increase the current BLOB sequence number of the document. If *@SendingContent* is one, the current BLOB sequence number MUST be set to the current BLOB sequence number + *@BSNBump*.

@StreamSchema: Specifies the new stream schema of the document. If this parameter is not NULL, the current stream schema of the document MUST be set to *@StreamSchema*.

@DocId: Output parameter. The document identifier (2) of the updated document.

@Level: Output parameter. A **Publishing Level Type** value (section [2.2.2.6](#)) indicating the maximum publishing level of the updated document to be returned to the front-end Web server if multiple publishing levels of the document are available.

@DoclibRowId: Output parameter. The identifier of the list item representing the updated document. This value MUST be NULL if the document is not stored in a list (1).

@DocDTM: Output parameter. The datetime in UTC of the last modification time stamp of the updated document. If *@DocIncomingDTM* is NULL, this value MUST be set to the current UTC datetime according to the back-end database server; otherwise, the value MUST be set to *@DocIncomingDTM*.

@DocUIVersion: Output parameter. The UI version number associated with the updated document. This value MUST be NULL in the case of a document that does not exist.

@DocFlagsOut: Output parameter. A **Doc Flags** value (section [2.2.2.3](#)), set to the document flag value of the updated document.

@DocVersionOut: Output parameter. The internal version counter value of the updated document. If the document was not updated, this parameter MUST be set to NULL.

@RequestGuid: The optional request identifier for the current request.

Return Values: The **proc_UpdateDocument** stored procedure returns an integer return code, which MUST be listed in the following table.

| Value | Description |
|-------|--|
| 0 | Successful execution. |
| 3 | The document does not exist or has been deleted. |
| 5 | The user accessing the document is not the owner of the draft, and ownership restriction of the draft is being enforced. |
| 30 | An IO error occurred while deleting implementation-specific file fragments. |
| 33 | Locking violation or mismatch of <i>@RefreshLock</i> and short-term lock status before lock timeout. |
| 80 | This document doesn't have a document stream, but a content file exists. |
| 87 | The list item for this document could not be added. |
| 154 | The Minor UI version number has exceeded its limit. |
| 158 | Checkout is enforced, but the document is not checked out. |
| 160 | Document is at draft Level and the user accessing the document is not permitted to see drafts or is not the draft owner. |
| 173 | User does not have permissions for the type of checkout desired. |
| 212 | The document is locked (either not the current version and is currently checked out or not enough lock quota); the document cannot be updated. |
| 288 | The document is not the current version; the current user is not the owner; the document cannot be updated. |
| 1150 | Internal Version number mismatch prevented document update. |
| 1630 | Unsupported file type. |
| 1816 | The site collection does not have enough quota to update the document. |
| 6002 | A short-term lock could not be obtained or modified because a shared short-term lock already exists. A shared short-term lock is used for read operations that do not change or update data, such as a SELECT statement. |
| 6009 | A short-term lock could not be obtained or modified because an exclusive short-term lock already exists. An exclusive short-term lock is used for data-modification operations, such as INSERT, UPDATE, or DELETE. Such a lock ensures that multiple updates cannot be made to the same resource at the same time. |

The **proc_UpdateDocument** stored procedure can return zero to three result sets in the order listed in the following sections.

3.1.5.126.1 Site List For Normalization Result Set

The **Site List For Normalization Result Set** returns a list of URLs for the immediate child Sites of the Site containing the newly updated document. When the input parameter *@GetWebListForNormalization* is set to "1" and execution has been successful up to the point of updating the document, the **Site List For Normalization Result Set** MUST be returned. The **Site List For Normalization Result Set** MUST contain one row for each subsite found.

The **Site List For Normalization Result Set** is defined in the Common Result Sets **URL Result Set** (section [2.2.4.27](#)).

3.1.5.126.2 Site Audit Mask Result Set

The **Site Audit Mask Result Set** returns audit configuration information. When the input parameter `@AuditMask` is set to "1", the **Site Audit Mask Result Set** MUST be returned, and MUST contain only one row. The **Site Audit Mask Result Set** is defined in the Common Result Sets **Site Audit Mask Result Set** (section [2.2.4.22](#)).

3.1.5.126.3 Lock Information Result Set

The **Lock Information Result Set** returns short-term lock information for the document. The **Lock Information Result Set** MUST be returned when a successful document update has been completed, and a document has either been checked in, remains checked out, has been locked, or remains locked. The **Lock Information Result Set** MUST NOT be returned if the document has not been successfully updated or `@LockTimeout` is NULL. The **Lock Information Result Set** MUST contain only one row.

| | |
|--------------------------------|-----------------------------|
| <code>tp_Login</code> | <code>nvarchar(255),</code> |
| <code>CheckoutDate</code> | <code>datetime,</code> |
| <code>{CheckoutExpires}</code> | <code>datetime;</code> |

tp_Login: The login name of the user to whom the document is checked out. If the document is currently checked in, then this MUST be NULL.

CheckoutDate: A **datetime** in UTC indicating when this document was checked out. If the document is currently checked in, then this MUST be NULL.

{CheckoutExpires}: A **datetime** in UTC indicating when the short-term lock for this document will expire. If the document is currently checked in or has a long term checkout, then this MUST be NULL.

3.1.5.127 proc_UpdateListItem

The **proc_UpdateListItem** stored procedure is invoked to update a list item in a document library or list.

```
PROCEDURE proc_UpdateListItem(  
    @SiteId                uniqueidentifier,  
    @WebId                 uniqueidentifier,  
    @ListId                uniqueidentifier,  
    @ItemId                int,  
    @RowOrdinal            tinyint,  
    @Size                  int,  
    @ExtraItemSize         int                = NULL,  
    @ItemName              nvarchar(255)     = NULL,  
    @UseNvarcharListItemName bit            = 1,  
    @ItemDirName           nvarchar(256)     = NULL    OUTPUT,  
    @ItemLeafName          nvarchar(256)     = NULL    OUTPUT,  
    @UserId                int,  
    @Level                 tinyint           = 1      OUTPUT,  
    @TimeNow               datetime,  
    @NeedsAuthorRestriction bit            = 0,  
    @NeedsDraftOwnerRestriction bit         = 0,
```

```

@PreserveVersion          bit          = 0,
@IsMeetingsList          bit          = NULL,
@IsIssueList              bit          = NULL,
@IsNotUserDisplayed      bit          = NULL,
@SystemUpdate             bit          = 0,
@ChangeLevel              bit          = 0,
@CheckinItem              bit          = 0,
@NeedClone                bit          = 0,
@MajorVersionsLimit      int          = 0,
@MajorMinorVersionsLimit int          = 0,
@IsDocLib                 bit          = 0,
@CheckSchemaVersion      int          = NULL,
@SortTypeReversed        bit          = NULL,
@tp_Ordering              varchar(512) = NULL,
@tp_ThreadIndex           varbinary(512) = NULL,
@tp_HasAttachment         bit          = NULL,
@tp_ModerationStatus     int          = NULL,
@tp_IsCurrent             bit          = NULL,
@tp_ItemOrder            float         = NULL,
@tp_Version               int          = NULL,
@tp_InstanceID           int          = NULL,
@tp_ContentTypeId        tContentTypeId = NULL,
@tp_CopySource            nvarchar(260) = NULL,
@tp_HasCopyDestinations  bit          = NULL,
@OnRestore                bit          = 0,
@BumpLastDelete           bit          = NULL,
@CreateItemVersion        bit          = 0,
@UIVersion                int          = NULL,
@NewUIVersion             int          = NULL OUTPUT,
@ReturnRowset             bit          = 1,
@tp_Author                int          = NULL,
@tp_Editor                int          = NULL,
@tp_Created               datetime     = NULL,
@tp_Modified              datetime     = NULL,
@tp_WorkflowVersion       int          = NULL,
@tp_ColumnSet             xml          = NULL,
@nvarchar1                nvarchar(255) = NULL,
@MtgEventType             int          = NULL,
@RecurrenceID             datetime     = NULL,
@IsDetached               int          = NULL,
@eventData                varbinary(max) = NULL,
@acl                      varbinary(max) = NULL,
@IsFirstRow               bit          = 1,
@tp_AppAuthor             int          = NULL,
@tp_AppEditor             int          = NULL,
@RequestGuid              uniqueidentifier = NULL OUTPUT
);

```

@SiteId: The site collection identifier for the site collection containing the list item to be updated.

@WebId: The site identifier for the site containing the list item.

@ListId: The list identifier of the List containing the list item.

@ItemId: The **item identifier** of the list item.

@RowOrdinal: The 0-based ordinal of the row to update in the set of rows representing this list item in the **AllUserData** table (section [2.2.6.2](#)). If a list item requires multiple rows to represent it in the

AllUserData table because it contains more defined data columns than will fit in a single row, then this parameter specifies which row to update with this call. If more than one row of data for the list item is to be updated, then the front-end Web server MUST call **proc_UpdateListItem** once for each updated row. This parameter MUST NOT be NULL.

@Size: The new size, in bytes, of the list item row to be updated. This parameter MUST NOT be NULL.

@ExtraItemSize: The size, in bytes, of the predefined SQL parameter fields in the list item row.

@ItemName: The new display name for the list item.

@UseNvarchar1ItemName: If *@ItemName* is NULL, then this bit flag specifies use of the content of *@nvarchar1* for the new display name for the list item. If *@ItemName* is not NULL, then this parameter MUST be ignored.

@ItemDirName: An output parameter containing the directory name of the updated list item.

@ItemLeafName: An output parameter containing the leaf name of the updated list item.

@UserId: The user identifier for the current user. This parameter is used for comparison when the *@NeedsAuthorRestriction* or *@NeedsDraftOwnerRestriction* parameters are set. If this parameter is NULL, then the user identifier stored as the list item's **editor** MUST be used as the current user.

@Level: A **Publishing Level Type** value specifying the publishing status of the updated list item.

@TimeNow: The current **datetime** in UTC. This parameter MUST NOT be NULL.

@NeedsAuthorRestriction: A bit flag specifying whether or not only the list item's **author** is permitted to update the list item. If this parameter is set to 1, then the current user MUST be the list item's author.

@NeedsDraftOwnerRestriction: A bit flag specifying whether or not only the list item's draft owner is permitted to update the list item. If this parameter is set to 1, the current user MUST be the list item's draft owner.

@PreserveVersion: A bit flag specifying whether to preserve the internal version number of the list item to be updated. If this parameter is set to 1, then the internal version number of the list item MUST NOT be incremented as part of the update. Otherwise, if the list item is updated, then the current internal version number MUST be incremented by an implementation-specific amount.

@IsMeetingsList: A bit flag specifying whether the list item is contained in a Meetings List (a List with a **List Server Template** value of 200).

@IsIssueList: A bit flag specifying whether the list item is contained in an Issues List (a List with a **List Server Template** value of 1100). This parameter MUST be ignored.

@IsNotUserDisplayed: A bit flag specifying whether the display name of the current user is not to be displayed in logging events (1) for this update. If this parameter is set to 1, then the display name of the current user MUST NOT be used when **proc_UpdateListItem** logs events (1) because of the update, and the string "***" MUST be used instead.

@SystemUpdate: A bit flag specifying whether to leave the last modification time stamp and the list item editor unchanged during this update. If this parameter is set to 1, then the list item MUST be updated without affecting the current last modification time or list item editor.

@ChangeLevel: A bit flag specifying whether to recalculate the publishing level of the list item as part of the update. If this parameter is set to 1, then the list item's publishing level MUST be recalculated.

@CheckinItem: A bit flag specifying whether to set the publishing level for the updated list item to published. If this parameter is set to 1, then **proc_UpdateListItem** MUST set the updated List Item's publishing level to 1 (published).

@NeedClone: A bit flag specifying whether a copy of the list item as a draft version is made as part of this update. If this parameter is set to 1, then the publishing level specified by the *@Level* parameter MUST also be set to 1 (published).

@MajorVersionsLimit: The number of major versions to keep of the list item.

@MajorMinorVersionsLimit: The total combined number of major versions and minor versions to keep of the list item.

@IsDocLib: A bit flag specifying whether the list item to be updated is contained within a document library. If this parameter is set to 1, then the List specified by *@ListId* MUST be a document library.

@CheckSchemaVersion: This specifies a list schema version number to compare with the list schema version of the list item's containing List. If this parameter is not NULL and does not match the current list schema version number, then the list item MUST NOT be updated.

@SortTypeReversed: If this parameter is 1, then the sort behavior for this item MUST be changed to the opposite of the value of the list item's type. If this parameter is 0 or NULL, then the sort behavior for this item MUST NOT be changed.

@tp_Ordering: This specifies the threading structure for this list item in a legacy Discussion Board List (a list with a **List Base Type** (section [2.2.1.2.11](#)) of 3) as a concatenation of timestamp values in yyyyMMddHHmmss format. For all list items in lists with other **List Base Types**, this parameter MUST be NULL.

@tp_ThreadIndex: This specifies the list item's position within a threaded legacy Discussion Board List (a List with a **List Base Type** of 3) as a binary structure. For all List Items in Lists with other **List Base Types**, this parameter MUST be NULL.

@tp_HasAttachment: A bit flag specifying whether the list item has an associated attachment.

@tp_ModerationStatus: A Moderation Status value specifying the current moderation approval status of this list item.

@tp_IsCurrent: A bit flag specifying whether this is the current version of this publishing level of the list item.

@tp_ItemOrder: This specifies the implementation-specific order in which the list item is displayed with other list items from the same list. This value can be the same as other list items in the list.

@tp_Version: The internal version number value of the list item to update. If this parameter is not NULL and does not equal the current value of the internal version number of the list item, then the item MUST NOT be updated.

@tp_InstanceID: This parameter MUST be ignored.

@tp_ContentTypeId: This specifies the Content Type Identifier of the content type for this list item. For details on the **tContentTypeId** custom type, see section [2.2.1.1.1](#).

@tp_CopySource: The URL used as a source for this list item. If this list item was not copied from a source list item, then this value MUST be NULL.

@tp_HasCopyDestinations: A bit flag specifying whether destination locations have been set for this list item to be copied to. If this list item does not have a destination location set, then this value MUST be 0.

@OnRestore: A bit flag specifying whether this list item is being inserted by an implementation-specific backup restore operation.

@BumpLastDelete: A bit flag specifying whether to update the **tp_LastDeleted** (section [2.2.4.14](#)) property on the List specified by *@ListId*. If set to 0, then the **tp_LastDeleted** property MUST NOT be updated.

@CreateItemVersion: A bit flag specifying whether to create a new version of the list item as part of this update.

@UIVersion: The UI version number to set for the list item.

@NewUIVersion: An output parameter returning the UI version number set for the list item, which MUST be NULL if one was not assigned.

@ReturnRowset: A bit flag specifying whether to return an **Item Update Result Set** (section [3.1.5.127.1](#)).

@tp_Author: The User Identifier to set as the author of the list item.

@tp_Editor: The User Identifier to set as the last editor of the list item.

@tp_Created: A **datetime** in UTC to set as the list item's creation time stamp. If this parameter is NULL or *@SystemUpdate* is "1", then the current time stamp MUST not be updated.

@tp_Modified: A **datetime** in UTC to set as the list item's last modified time stamp. If this parameter is NULL or *@SystemUpdate* is "1", then the current time stamp MUST not be updated. If this parameter is NULL and *@SystemUpdate* is not "1", then *@TimeNow* SHOULD be set as the list item's last modified time stamp.

@tp_WorkflowVersion: If this list item is part of a workflow (2), then this specifies the value to set denoting the state of this list item within that workflow (2). If this list item is not part of a workflow (2), then this value MUST be NULL.

@tp_ColumnSet: The XML fragment that specifies the values of user-defined columns in the list. The name of each element specified in this parameter MUST be one of the columns defined in the **AllUserData table** (see section [2.2.6.2](#)) with the SPARSE keyword.

@nvarchar1: User-defined column in the list containing a value of type **nvarchar**. If the column contains no data, then the value MUST be NULL.

@MtgEventType: If *@IsMeetingsList* is "1", this parameter specifies the type of calendar event.

@RecurrenceID: If *@IsMeetingsList* is "1", this parameter specifies a particular instance of a recurring meeting.

@IsDetached: If *@IsMeetingsList* is "1" and this parameter is "1", it specifies that this list item is a detached item from a meeting series.

@eventData: Contains implementation-specific event (1) data significant to the front-end Web server but otherwise opaque to the back-end database server, to be stored by the back-end database server for eventual writing to a log file.

@acl: The binary serialization of the **WSS ACL** Format access control list for the data supplied in *@eventData*, to be stored with the data.

@IsFirstRow: If *@RowOrdinal* is 0, then this parameter MUST be 1. Otherwise this parameter MUST be 0.

@tp_AppAuthor: The app principal identifier of the app principal who created the list item.

@tp_AppEditor: The app principal identifier of the app principal who last edited the list item.

@RequestGuid: The optional request identifier for the current request.

Return Values: The **proc_UpdateListItem** stored procedure returns an integer return code, which MUST be in the following table.

| Value | Description |
|-------|---|
| 0 | Successful execution. |
| 3 | Could not create a unique filename, or the specified Site does not exist. |
| 5 | The current user does not have sufficient permissions to update the list item. |
| 13 | The list item to be added is not valid. |
| 87 | Unable to update the list item because the input parameters do not match an existing list item, or an error occurred during a table update operation. |
| 160 | A valid User Identifier was not specified. |
| 212 | The database for the Site is locked. |
| 288 | The list item cannot be published by the current user because a different User is listed as the draft owner. |
| 1150 | Failed to update the list item. |
| 1638 | The current schema version of the List does not match the value specified in <i>@CheckSchemaVersion</i> . |
| 1639 | Only a published list item can be copied. |
| 1816 | The site collection is over its allocated size quota. |
| 4005 | The specified list item was not found. |

The **proc_UpdateListItem** stored procedure MUST return zero or one result sets as follows.

3.1.5.127.1 Item Update Result Set

The **Item Update Result Set** returns status information about the list item update. The Item Update Result Set MUST only be returned when the *@ReturnRowset* parameter is set to 1, and MUST contain a single row.

| | |
|--------------------|-------------------|
| {ReturnCode} | int, |
| {RowsAffected} | int, |
| {Version} | int, |
| {Author} | int, |
| {Id} | uniqueidentifier, |
| {AuditMask} | int, |
| {InheritAuditMask} | int, |
| {GlobalAuditMask} | int, |
| {FullUrl} | nvarchar(260); |

{ReturnCode}: The return code value returned by **proc_UpdateListItem**.

{RowsAffected}: The count of the **AllUserData** table (section [2.2.6.2](#)) rows updated by **proc_UpdateListItem**.

{Version}: The current value of the internal version number for the updated list item. This MUST be NULL if the specified list item was not found.

{Author}: The User Identifier for the author of the updated list item. This MUST be NULL if the specified list item was not found.

{Id}: The List Item Identifier of the updated list item. This MUST be NULL if the specified list item was not found.

{AuditMask}: The **Audit Flags** (section [2.2.2.1](#)) value for the updated list item. This MUST be NULL if the specified list item was not found.

{InheritAuditMask}: The **Audit Flags** value for the updated list item inherited from its containing List or document library. This MUST be NULL if the specified list item was not found.

{GlobalAuditMask}: The global **Audit Flags** value for the site collection specified by *@SiteId*. This MUST be NULL if the specified site collection was not found.

{FullUrl}: The store-relative form URL for the updated list item. This MUST be NULL if the specified list item was not found.

3.1.5.128 proc_UpdateListSettings

The **proc_UpdateListSettings** stored procedure is invoked to update list (1) metadata.

```

PROCEDURE proc_UpdateListSettings (
    @SiteId                uniqueidentifier,
    @WebId                 uniqueidentifier,
    @ListId                uniqueidentifier,
    @BaseType              int,
    @ServerTemplate        int,
    @Title                 nvarchar(255),
    @ReadSecurity          int,
    @WriteSecurity         int,
    @NewDefaultView       uniqueidentifier,
    @Description           nvarchar(max),
    @TemplateDirName       nvarchar(256),
    @TemplateLeafName     nvarchar(128),
    @Fields                tCompressedString,
    @Direction            int,
    @EventSinkAssembly    nvarchar(255),
    @EventSinkClass       nvarchar(255),

```

```

@EventSinkData          nvarchar(255),
@Flags                  bigint,
@ImageUrl               nvarchar(255),
@ThumbnailSize          int,
@WebImageWidth          int,
@WebImageHeight         int,
@Version                int,
@ConvertToGlobalMtgDataList bit,
@emailAlias             nvarchar(128),
@SendToLocation         nvarchar(512),
@NavBarEid             int,
@AddOrRemoveFromNavBar bit,
@UseRootFolderForNav   bit,
@MajorVersionCount     int,
@MajorMinorVersionCount int,
@WorkflowId            uniqueidentifier,
@RemoveSystemAlerts    bit,
@Followable            bit,
@ValidationFormula      nvarchar(1024),
@ValidationMessage      nvarchar(1024),
@RequestGuid           uniqueidentifier = NULL OUTPUT
);

```

@SiteId: The site collection identifier of the site collection containing the list (1) whose metadata is being updated.

@WebId: The site identifier of the site (2) containing the list (1).

@ListId: The list identifier of the list (1) to be updated.

@BaseType: A **List Base Type** value (section [2.2.1.2.11](#)). If **@ConvertToGlobalMtgDataList** is equal to "1", this value **MUST** be used to set the **List Base Type**; otherwise, the value **MUST** be ignored.

@ServerTemplate: The identifier for the **List Server Template** (section [2.2.1.2.12](#)) defining the base structure of this list (1). If **@ConvertToGlobalMtgDataList** is equal to "1", this value **MUST** be used to set the **List Server Template**; otherwise, the value **MUST** be ignored.

@Title: A user-provided title text for the list (1). If this parameter is NULL, the current value **MUST NOT** be changed.

@ReadSecurity: Specifies the security policy that **MUST** be set for read access on list items in the list (1). Valid read security values are listed in the following table.

| Value | Description |
|-------|--|
| 1 | Users with read permissions on this list (1) can read all list items. |
| 2 | Users with read permissions on this list (1) can only read their own list items. |
| NULL | There MUST be no changes to read security for the list (1). |

@WriteSecurity: Specifies the security policy that **MUST** be set for write access on list items in the list (1). Valid write security values are listed in the following table.

| Value | Description |
|-------|---|
| 1 | Users with write permissions on this list (1) can create list items and have write access to all list items. |
| 2 | Users with write permissions on this list (1) can create list items and have write access to their own list items only. |
| 4 | Users have no write access to any list items. |
| NULL | There MUST be no changes to write security for the list (1). |

@NewDefaultView: A **View Identifier** (section [2.2.1.1.14](#)) of a defined list view to be displayed by default when navigating to the list (1). If this parameter is NULL, the current value MUST NOT be changed.

@Description: A user-provided readable text description for the list (1). If this parameter is NULL, the current value MUST NOT be changed.

@TemplateDirName: Directory name for the document template (2) associated with the list (1). This parameter can be NULL. The parameter MUST be ignored if *@TemplateLeafName* is NULL or is an empty string.

@TemplateLeafName: Leaf name for the document template (2) associated with the list (1). If *@TemplateLeafName* is NULL, there MUST be no change to the current document template (2). If *@TemplateLeafName* contains an empty string, the current document template (2) MUST be set to NULL. If *@TemplateLeafName* is not NULL and is not an empty string, the current document template (2) MUST be set to the **Document Identifier** (section [2.2.1.1.2](#)) of the document template (2) specified by *@TemplateDirName* and *@TemplateLeafName*.

@Fields: Specifies the field definitions for the list (1), consisting of the concatenation of an implementation-specific version string for the list template, followed by an XML representation of the field definitions. If this parameter is NULL, the current value MUST NOT be changed.

@Direction: An enumerated value specifying the direction of text flow for front-end Web server elements presented by this list (1). If this parameter is NULL, the current value MUST NOT be changed. Otherwise, the parameter MUST be one of the following values.

| Value | Description |
|-------|-------------------------------------|
| 0 | No explicit direction is specified. |
| 1 | Text flow is left to right. |
| 2 | Text flow is right to left. |

@EventSinkAssembly: A .NET assembly name for an event sink handler for the list (1). If this parameter is NULL, the current value MUST not be changed. If this parameter is an empty string, the current value MUST be set to NULL.

@EventSinkClass: A .NET assembly class identifier for an event sink handler for the list (1). If this parameter is NULL, the current value MUST not be changed. If this parameter is an empty string, the current value MUST be set to NULL.

@EventSinkData: Data for an event sink handler for the list (1). If this parameter is NULL, the current value MUST not be changed. If this parameter is an empty string, the current value MUST be set to NULL.

@Flags: A **List Flags** value (section [2.2.2.5](#)) for the list (1). If **@Fields** is not NULL, this value MUST be a bitwise OR with 0x800000 (LP_FIELDSCHEMAMODIFIED). If this parameter is NULL, the current value MUST NOT be changed.

@ImageUrl: A **site-relative URL** holding an image associated with the list (1). If this parameter is NULL, the current value MUST NOT be changed.

@ThumbnailSize: A value specifying the width in pixels used by lists (1) that have a **List Server Template** value (section [2.2.1.2.12](#)) of 109 (Image Library Template) to determine the rendering size of an image thumbnail. If this parameter is NULL, the current value MUST NOT be changed.

@WebImageWidth: A value specifying the width in pixels used by lists (1) that have a **List Server Template** value of 109 (Image Library Template) to determine the rendering width of an image. If this parameter is NULL, the current value MUST NOT be changed.

@WebImageHeight: A value specifying the height in pixels used by lists (1) that have a **List Server Template** value of 109 (Image Library Template) to determine the rendering height of an image. If this parameter is NULL, the current value MUST NOT be changed.

@Version: An integer used to match on the internal version counter of the list (1) to be updated. This is used to prevent updates with out-of-date data. On successful execution, the internal version counter value of the list (1) will be incremented by one. If this parameter does not match the current version, the list (1) MUST not be updated.

@ConvertToGlobalMtgDataList: Used to convert the data of the list (1) to use global meeting data. If this parameter is set to one, the data MUST be converted to global meeting data and the **List Server Template** specified by **@ServerTemplate** MUST NOT be any of the following.

| Value | Description |
|-------|--------------|
| 200 | Meeting |
| 202 | Meeting User |
| 212 | Homepage |

If set to any other value or NULL, the meeting data for this list (1) MUST NOT be changed.

@EmailAlias: The email alias of the list (1). This alias is used to allow documents and list items to be sent directly to this list (1) through an implementation-specific email-handling feature. If this parameter is NULL, the current value MUST NOT be changed.

@SendToLocation: An implementation-specific Send-To string holding a URL used for the list (1). If this parameter is NULL, the current value MUST NOT be changed.

@NavBarEid: Specifies a **navigation node element identifier** for the parent **navigation node** of the node that will represent the list (1). If **@AddOrRemoveFromNavBar** is NULL or zero, this parameter MUST be ignored. Otherwise, it MUST contain a valid navigation node element identifier.

@AddOrRemoveFromNavBar: Specifies whether to add or remove this list (1) from the site's top link bar. If this parameter is set to "0" and the list (1) was updated, the list (1) MUST be removed from the site's top link bar. If this parameter is NULL, there MUST be no changes to the site's top link bar. If this parameter is set to "1" and the list (1) was updated and the list (1) is not in the site's top link bar, the list (1) MUST be added to the site's top link bar. To move nodes from one location to another, the navigation node should be first removed and then re-added with the new desired setting or else duplicate node entries will occur.

@UseRootFolderForNav: Specifies whether the root folder of the list (1) is used for the list (1) entry in the site's top link bar, instead of the default view page. If this parameter is set to "1" and the list (1) was updated, the root folder of the list (1) MUST be set as the top link bar target. If this parameter is set to "0" and the list (1) was updated, the default view page for the list (1) MUST be set as the top link bar target. If the **@AddOrRemoveFromNavBar** parameter is set to NULL, this parameter MUST also be NULL. Otherwise, this parameter can be NULL, which MUST have the effect of being set to "0". To change the root folder navigation from one node to another, the current navigation node SHOULD be first removed and the new one added with the desired setting or else duplicate node entries will occur.

@MajorVersionCount: Specifies the maximum number of major versions of list items to be retained by the list (1).

@MajorMinorVersionCount: Specifies the maximum number of minor versions of list items to be retained by the list (1).

@WorkflowId: Specifies the **Workflow Identifier** (section [2.2.1.1.16](#)) of the default workflow (2) of the list (1).

@RemoveSystemAlerts: A bit flag specifying whether to remove system alerts (1) for this list (1) from the email subscriptions for the system administration user. If this parameter is set to "1", system alerts (1) on the list (1) will be removed.

@Followable: If this list (1) is followable, this value MUST be one. Otherwise, it MUST be zero.

@ValidationFormula: The implementation-specific validation formula to be used for items in this list (1). If this parameter is NULL, the current value MUST NOT be changed.

@ValidationMessage: The message to display to the user when the implementation-specific list (1) validation formula fails. If this parameter is NULL, the current value MUST NOT be changed.

@RequestGuid: The optional request identifier for the current request.

Return Values: The **proc_UpdateListSettings** stored procedure returns an integer return code that MUST be listed in the following table.

| Value | Description |
|-------|--|
| 0 | Successful execution. |
| 3 | The site (2) does not exist or list (1) does not exist. |
| 13 | @ConvertToGlobalMtgDataList is set to one and @ServerTemplate is 200, 202, or 212 so list (1) cannot use global meeting data. |
| 15 | The document template (2) URL (combination of @TemplateDirName and @TemplateLeafName) is not valid. |
| 52 | Another list (1) with @Title already exists. |
| 1150 | @Version did not match the current version of the list (1). |
| 5069 | @ReadSecurity is 0x00000002 (LSReadOnlyMyItems) and @WriteSecurity is not NULL and the list (1) contains a field (2) with an implementation-specific list (1) validation constraint. |

The **proc_updateListSettings** stored procedure MUST NOT return any result sets.

3.1.5.129 proc_UpdateUserInfoInTableFromRowUpdater

The **proc_UpdateUserInfoInTableFromRowUpdater** stored procedure updates the user information data for the specified user.

```
PROCEDURE proc_UpdateUserInfoInTableFromRowUpdater (
    @SiteId                uniqueidentifier,
    @UserId                int,
    @Title                 nvarchar(255)      = NULL,
    @Email                 nvarchar(255)      = NULL,
    @IsActive              bit                = NULL,
    @Locale                 int                = NULL,
    @CalendarType           smallint           = NULL,
    @AdjustHijriDays        smallint           = NULL,
    @TimeZone               smallint           = NULL,
    @Collation              smallint           = NULL,
    @Time24                 bit                = NULL,
    @AltCalendarType        tinyint           = NULL,
    @CalendarViewOptions    tinyint           = NULL,
    @WorkDays               smallint           = NULL,
    @WorkDayStartHour       smallint           = NULL,
    @WorkDayEndHour         smallint           = NULL,
    @MobileNumber           nvarchar(127)      = NULL,
    @MUILanguages           varchar(64)        = NULL,
    @ContentLanguages        varchar(64)        = NULL,
    @RequestGuid            uniqueidentifier    = NULL OUTPUT
);
```

@SiteId: The **Site Collection Identifier** (section [2.2.1.1.9](#)) of the site collection containing the user whose information is to be updated.

@UserId: The User Identifier (section [2.2.1.1.13](#)) for the user whose information is to be updated.

@Title: The user-friendly display name of the user. If this parameter is NULL, then the display name MUST be set to the empty string.

@Email: The email address of the user. If this parameter is NULL, then the email address MUST be set to the empty string.

@IsActive: A bit flag specifying whether the user is an active user in the site collection. This flag is set to 0 if the User is not an active user. This flag is set to 1 to indicate otherwise. If this flag is NULL, then the value MUST NOT be changed.

@Locale: An LCID specifying the preferred locale settings to be used when formatting and displaying UI for the user.

@CalendarType: The **Calendar Type** (section [2.2.1.2.3](#)) to be used when processing date values for this user.

@AdjustHijriDays: If the **@CalendarType** parameter value is 6, then this parameter specifies the number of days to extend or reduce the current month in Hijri calendars for this User.

@TimeZone: The Time Zone Identifier for the time zone to be used when displaying time values for this User.

@Collation: The **Collation Order** (section [2.2.1.2.4](#)) to be used when displaying information to this User.

@Time24: A bit flag which specifies whether to use a 24-hour time format when displaying time values to this User. If this parameter is set to 1, then the 24-hour time format is used; otherwise, the 12-hour time format is used.

@AltCalendarType: The **Calendar Type** of an alternate calendar for processing date values for this User.

@CalendarViewOptions: A **Calendar View Options Type** (section [2.2.3.1](#)) which specifies the calendar display options setting for this User.

@WorkDays: A set of **Workdays Flags** (section [2.2.2.14](#)) which specify the week days defined as the work week for this User.

@WorkDayStartHour: The start time of the work day for this user, in minutes from 12:00AM. For example, the value 480 indicates 8:00AM.

@WorkDayEndHour: The end time of the work day for this user, in minutes from 12:00AM. For example, the value 1020 indicates 5:00PM.

@MobileNumber: The user-friendly text field that specifies the mobile phone number of the user.

@MUILanguages: A string that contains the distinct culture(s) for the user's preferred display language(s), separated by semicolon. This string can be NULL.

@ContentLanguages: A string that contains the distinct culture(s) for the user's preferred content language(s), separated by semicolon. This string can be NULL.

@RequestGuid: The optional request identifier for the current request.

Return Values: This procedure returns an integer return code which MUST be 0.

This procedure MUST return no result sets.

3.1.5.130 **proc_UrlToWebUrl**

The **proc_UrlToWebUrl** stored procedure returns the store-relative form URL of the site that contains a specified store-relative form URL and is inside a specific site collection.

```
PROCEDURE proc_UrlToWebUrl(  
    @WebSiteId          uniqueidentifier,  
    @Url                nvarchar(260),  
    @RequestGuid       uniqueidentifier = NULL OUTPUT  
);
```

@WebSiteId: The Site Collection Identifier (section [2.2.1.1.9](#)) for a site collection that contains the **@Url** parameter value. For successful execution, the Site Collection Identifier MUST match an existing site collection which could hold the **@Url** parameter value. If the identifier does not match an existing site collection, then an integer value of 1168 MUST be returned along with a **Web URL Result Set**.

@Url: A store-relative URL.

@RequestGuid: The optional request identifier for the current request.

Return Values: The **proc_UrlToWebUrl** stored procedure returns an integer return code which MUST be listed in the following table.

| Value | Description |
|-------|---|
| 0 | Successful execution. |
| 1168 | The site collection specified by <i>@WebSiteId</i> does not exist or <i>@Url</i> is not contained in the specified site collection. |

The **proc_UrlToWebUrl** stored procedure MUST return a single result set as follows.

3.1.5.130.1 Web URL Result Set

The **Web URL Result Set** returns the store-relative form URL of the site containing the *@Url* input parameter value. The **Web URL Result Set** MUST be returned and MUST contain one row.

```
{WebUrl} nvarchar(256);
```

{WebUrl}: The store-relative form URL of the site that contains the *@Url* parameter value. This MUST be an empty string when the *@Url* parameter is invalid or is not contained in the specified site collection or the specified site collection does not exist. *@Url* is only checked for whether a valid subsite path exists within *@Url*.

3.1.5.131 proc_WriteChunkToAllDocStreams

The **proc_WriteChunkToAllDocStreams** stored procedure establishes new document content associated with the document specified by *@DocId*, or appends to already existing document content established by an earlier invocation of **proc_WriteChunkToAllDocStreams**.

```
PROCEDURE dbo.proc_WriteChunkToAllDocStreams (
    @SiteId uniqueidentifier,
    @DocId uniqueidentifier,
    @Offset int,
    @00 varbinary(max) = NULL,
    @01 varbinary(max) = NULL,
    @02 varbinary(max) = NULL,
    @03 varbinary(max) = NULL,
    @04 varbinary(max) = NULL,
    @05 varbinary(max) = NULL,
    @06 varbinary(max) = NULL,
    @07 varbinary(max) = NULL,
    @08 varbinary(max) = NULL,
    @09 varbinary(max) = NULL,
    @0A varbinary(max) = NULL,
    @0B varbinary(max) = NULL,
    @0C varbinary(max) = NULL,
    @0D varbinary(max) = NULL,
    @0E varbinary(max) = NULL,
    @0F varbinary(max) = NULL,
    @10 varbinary(max) = NULL,
    @11 varbinary(max) = NULL,
    @12 varbinary(max) = NULL,
    @13 varbinary(max) = NULL,
    @14 varbinary(max) = NULL,
    @15 varbinary(max) = NULL,
    @16 varbinary(max) = NULL,
    @17 varbinary(max) = NULL,
    @18 varbinary(max) = NULL,
```

@19 varbinary(max) = NULL,
@1A varbinary(max) = NULL,
@1B varbinary(max) = NULL,
@1C varbinary(max) = NULL,
@1D varbinary(max) = NULL,
@1E varbinary(max) = NULL,
@1F varbinary(max) = NULL,
@20 varbinary(max) = NULL,
@21 varbinary(max) = NULL,
@22 varbinary(max) = NULL,
@23 varbinary(max) = NULL,
@24 varbinary(max) = NULL,
@25 varbinary(max) = NULL,
@26 varbinary(max) = NULL,
@27 varbinary(max) = NULL,
@28 varbinary(max) = NULL,
@29 varbinary(max) = NULL,
@2A varbinary(max) = NULL,
@2B varbinary(max) = NULL,
@2C varbinary(max) = NULL,
@2D varbinary(max) = NULL,
@2E varbinary(max) = NULL,
@2F varbinary(max) = NULL,
@30 varbinary(max) = NULL,
@31 varbinary(max) = NULL,
@32 varbinary(max) = NULL,
@33 varbinary(max) = NULL,
@34 varbinary(max) = NULL,
@35 varbinary(max) = NULL,
@36 varbinary(max) = NULL,
@37 varbinary(max) = NULL,
@38 varbinary(max) = NULL,
@39 varbinary(max) = NULL,
@3A varbinary(max) = NULL,
@3B varbinary(max) = NULL,
@3C varbinary(max) = NULL,
@3D varbinary(max) = NULL,
@3E varbinary(max) = NULL,
@3F varbinary(max) = NULL,
@40 varbinary(max) = NULL,
@41 varbinary(max) = NULL,
@42 varbinary(max) = NULL,
@43 varbinary(max) = NULL,
@44 varbinary(max) = NULL,
@45 varbinary(max) = NULL,
@46 varbinary(max) = NULL,
@47 varbinary(max) = NULL,
@48 varbinary(max) = NULL,
@49 varbinary(max) = NULL,
@4A varbinary(max) = NULL,
@4B varbinary(max) = NULL,
@4C varbinary(max) = NULL,
@4D varbinary(max) = NULL,
@4E varbinary(max) = NULL,
@4F varbinary(max) = NULL,
@50 varbinary(max) = NULL,
@51 varbinary(max) = NULL,
@52 varbinary(max) = NULL,
@53 varbinary(max) = NULL,

@54 varbinary(max) = NULL,
@55 varbinary(max) = NULL,
@56 varbinary(max) = NULL,
@57 varbinary(max) = NULL,
@58 varbinary(max) = NULL,
@59 varbinary(max) = NULL,
@5A varbinary(max) = NULL,
@5B varbinary(max) = NULL,
@5C varbinary(max) = NULL,
@5D varbinary(max) = NULL,
@5E varbinary(max) = NULL,
@5F varbinary(max) = NULL,
@60 varbinary(max) = NULL,
@61 varbinary(max) = NULL,
@62 varbinary(max) = NULL,
@63 varbinary(max) = NULL,
@64 varbinary(max) = NULL,
@65 varbinary(max) = NULL,
@66 varbinary(max) = NULL,
@67 varbinary(max) = NULL,
@68 varbinary(max) = NULL,
@69 varbinary(max) = NULL,
@6A varbinary(max) = NULL,
@6B varbinary(max) = NULL,
@6C varbinary(max) = NULL,
@6D varbinary(max) = NULL,
@6E varbinary(max) = NULL,
@6F varbinary(max) = NULL,
@70 varbinary(max) = NULL,
@71 varbinary(max) = NULL,
@72 varbinary(max) = NULL,
@73 varbinary(max) = NULL,
@74 varbinary(max) = NULL,
@75 varbinary(max) = NULL,
@76 varbinary(max) = NULL,
@77 varbinary(max) = NULL,
@78 varbinary(max) = NULL,
@79 varbinary(max) = NULL,
@7A varbinary(max) = NULL,
@7B varbinary(max) = NULL,
@7C varbinary(max) = NULL,
@7D varbinary(max) = NULL,
@7E varbinary(max) = NULL,
@7F varbinary(max) = NULL,
@80 varbinary(max) = NULL,
@81 varbinary(max) = NULL,
@82 varbinary(max) = NULL,
@83 varbinary(max) = NULL,
@84 varbinary(max) = NULL,
@85 varbinary(max) = NULL,
@86 varbinary(max) = NULL,
@87 varbinary(max) = NULL,
@88 varbinary(max) = NULL,
@89 varbinary(max) = NULL,
@8A varbinary(max) = NULL,
@8B varbinary(max) = NULL,
@8C varbinary(max) = NULL,
@8D varbinary(max) = NULL,
@8E varbinary(max) = NULL,

@8F varbinary(max) = NULL,
@90 varbinary(max) = NULL,
@91 varbinary(max) = NULL,
@92 varbinary(max) = NULL,
@93 varbinary(max) = NULL,
@94 varbinary(max) = NULL,
@95 varbinary(max) = NULL,
@96 varbinary(max) = NULL,
@97 varbinary(max) = NULL,
@98 varbinary(max) = NULL,
@99 varbinary(max) = NULL,
@9A varbinary(max) = NULL,
@9B varbinary(max) = NULL,
@9C varbinary(max) = NULL,
@9D varbinary(max) = NULL,
@9E varbinary(max) = NULL,
@9F varbinary(max) = NULL,
@A0 varbinary(max) = NULL,
@A1 varbinary(max) = NULL,
@A2 varbinary(max) = NULL,
@A3 varbinary(max) = NULL,
@A4 varbinary(max) = NULL,
@A5 varbinary(max) = NULL,
@A6 varbinary(max) = NULL,
@A7 varbinary(max) = NULL,
@A8 varbinary(max) = NULL,
@A9 varbinary(max) = NULL,
@AA varbinary(max) = NULL,
@AB varbinary(max) = NULL,
@AC varbinary(max) = NULL,
@AD varbinary(max) = NULL,
@AE varbinary(max) = NULL,
@AF varbinary(max) = NULL,
@B0 varbinary(max) = NULL,
@B1 varbinary(max) = NULL,
@B2 varbinary(max) = NULL,
@B3 varbinary(max) = NULL,
@B4 varbinary(max) = NULL,
@B5 varbinary(max) = NULL,
@B6 varbinary(max) = NULL,
@B7 varbinary(max) = NULL,
@B8 varbinary(max) = NULL,
@B9 varbinary(max) = NULL,
@BA varbinary(max) = NULL,
@BB varbinary(max) = NULL,
@BC varbinary(max) = NULL,
@BD varbinary(max) = NULL,
@BE varbinary(max) = NULL,
@BF varbinary(max) = NULL,
@C0 varbinary(max) = NULL,
@C1 varbinary(max) = NULL,
@C2 varbinary(max) = NULL,
@C3 varbinary(max) = NULL,
@C4 varbinary(max) = NULL,
@C5 varbinary(max) = NULL,
@C6 varbinary(max) = NULL,
@C7 varbinary(max) = NULL,
@C8 varbinary(max) = NULL,
@C9 varbinary(max) = NULL,

```
@CA varbinary(max) = NULL,  
@CB varbinary(max) = NULL,  
@CC varbinary(max) = NULL,  
@CD varbinary(max) = NULL,  
@CE varbinary(max) = NULL,  
@CF varbinary(max) = NULL,  
@D0 varbinary(max) = NULL,  
@D1 varbinary(max) = NULL,  
@D2 varbinary(max) = NULL,  
@D3 varbinary(max) = NULL,  
@D4 varbinary(max) = NULL,  
@D5 varbinary(max) = NULL,  
@D6 varbinary(max) = NULL,  
@D7 varbinary(max) = NULL,  
@D8 varbinary(max) = NULL,  
@D9 varbinary(max) = NULL,  
@DA varbinary(max) = NULL,  
@DB varbinary(max) = NULL,  
@DC varbinary(max) = NULL,  
@DD varbinary(max) = NULL,  
@DE varbinary(max) = NULL,  
@DF varbinary(max) = NULL,  
@E0 varbinary(max) = NULL,  
@E1 varbinary(max) = NULL,  
@E2 varbinary(max) = NULL,  
@E3 varbinary(max) = NULL,  
@E4 varbinary(max) = NULL,  
@E5 varbinary(max) = NULL,  
@E6 varbinary(max) = NULL,  
@E7 varbinary(max) = NULL,  
@E8 varbinary(max) = NULL,  
@E9 varbinary(max) = NULL,  
@EA varbinary(max) = NULL,  
@EB varbinary(max) = NULL,  
@EC varbinary(max) = NULL,  
@ED varbinary(max) = NULL,  
@EE varbinary(max) = NULL,  
@EF varbinary(max) = NULL,  
@F0 varbinary(max) = NULL,  
@F1 varbinary(max) = NULL,  
@F2 varbinary(max) = NULL,  
@F3 varbinary(max) = NULL,  
@F4 varbinary(max) = NULL,  
@F5 varbinary(max) = NULL,  
@F6 varbinary(max) = NULL,  
@F7 varbinary(max) = NULL,  
@F8 varbinary(max) = NULL,  
@F9 varbinary(max) = NULL,  
@FA varbinary(max) = NULL,  
@FB varbinary(max) = NULL,  
@FC varbinary(max) = NULL,  
@FD varbinary(max) = NULL,  
@FE varbinary(max) = NULL,  
@FF varbinary(max) = NULL,  
@RequestGuid uniqueidentifier = NULL OUTPUT)
```

@SiteId: The site collection identifier of the site collection containing the document.

@DocId: The document identifier (2) of the document.

@Offset: This parameter MUST be zero, if no document content corresponds to **@DocId**; otherwise, it MUST be the length, in bytes, of the document content which corresponded to **@DocId** before the stored procedure was invoked.

@00 -- @FF: 256 optional parameters. The non-NULL parameters, concatenated in order according to their name, interpreted as a hexadecimal number, MUST be stored or appended to the document content. If one of the parameters is NULL, all subsequent parameters MUST be NULL.

@RequestGuid: The optional request identifier for the current request.

Return Values: The **proc_WriteChunkToAllDocStreams** stored procedure returns an integer return code which MUST be listed in the following table.

| Value | Description |
|-------|-----------------------|
| 0 | Successful execution. |
| 29 | Unexpected error. |

The **proc_WriteChunkToAllDocStreams** stored procedure MUST NOT return a result set.

3.1.5.132 **proc_WriteStreamToRBS**

The **proc_WriteStreamToRBS** stored procedure establishes the remote BLOB storage identifier representing a new stream binary piece for a document. For additional information regarding remote BLOB storage, see [\[MS-WSSO\]](#) section 2.1.2.3.8.

```
PROCEDURE dbo.proc_WriteStreamToRBS (  
    @SiteId        uniqueidentifier,  
    @DocId         uniqueidentifier,  
    @Partition     tinyint,  
    @BSN          bigint,  
    @Size         int,  
    @Type         tinyint,  
    @Expiration   datetime,  
    @RbsId        varbinary(64)  
)
```

@SiteId: The site collection identifier of the site collection containing the document.

@DocId: The document identifier (2) of the document.

@Partition: The stream partition that the new stream binary piece belongs to.

@BSN: The BLOB sequence number of the new stream binary piece.

@Size: The size, in bytes, of the new stream binary piece.

@Type: The stream (1) type of the new stream binary piece.

@Expiration: The timestamp in UTC format of the stream binary piece. If the stream binary piece does not have an expiration, this parameter MUST be NULL.

@RbsId: The remote BLOB storage identifier for the new stream binary piece. For additional information regarding remote BLOB storage, see [\[MS-WSSO\]](#) section 2.1.2.3.8.

Return Values: The **proc_WriteStreamToRBS** stored procedure returns an integer return code which MUST be listed in the following table.

| Value | Description |
|-------|---|
| 0 | Successful execution. |
| 29 | Unexpected error. |
| 80 | A stream binary piece with the same BLOB sequence number or stream identifier already exists. |

The **proc_WriteStreamToRBS** stored procedure MUST NOT return a result set.

3.1.5.133 proc_WriteStreams

The **proc_WriteStreams** stored procedure creates a new stream binary piece for a document.

```

PROCEDURE dbo.proc_WriteStreams (
    @SiteId        uniqueidentifier,
    @DocId         uniqueidentifier,
    @Partition     tinyint,
    @StreamData    tvpStreamData READONLY,
    @BSNData       tvpBSNMetadata2 READONLY,
    @AddStream     bit,
    @OverwriteStream bit
)

```

@SiteId: The site collection identifier of the site collection containing the document.

@DocId: The document identifier (2) of the document.

@Partition: The stream partition that the new stream binary piece belongs to.

@StreamData: Contains subsets of data for the stream binary piece, corresponding to the Data, Offset, and Length columns.

@BSNData: Contains the metadata for the subsets of data for the stream binary piece, corresponding to *@StreamData*. The subset data in a position of *@StreamData* MUST correspond to the BLOB sequence number and **StreamId** specified in the same position in *@BSNData*.

@AddStream: If this parameter is one and a stream binary piece already exists with the same BLOB sequence number or stream identifier specified by *@BSNData*, BLOB sequence number and **StreamId**, this stored procedure MUST return 80.

@OverwriteStream: If this parameter is one, *@AddStream* MUST be ignored.

Return Values: The **proc_WriteStreams** stored procedure returns an integer return code which MUST be listed in the following table.

| Value | Description |
|-------|-----------------------|
| 0 | Successful execution. |

| Value | Description |
|-------|---|
| 2 | The document associated with the stream binary pieces to add does not exist. |
| 29 | Unexpected error. |
| 80 | A stream binary piece with the BLOB sequence number or stream identifier specified from <i>@BSNData</i> already exists. |

The **proc_WriteStreams** stored procedure MUST NOT return a result set.

3.1.5.134 proc_WriteStreamToSQL

The **proc_WriteStreamToSQL** stored procedure creates a new stream binary piece for a document.

```

PROCEDURE dbo.proc_WriteStreamToSQL (
    @SiteId        uniqueidentifier,
    @DocId         uniqueidentifier,
    @Partition     tinyint,
    @BSN           bigint,
    @Size          int,
    @Type          tinyint,
    @Expiration    datetime,
    @Data0 varbinary(max), @Length0 bigint, @Offset0 bigint,
    @Data1 varbinary(max), @Length1 bigint, @Offset1 bigint,
    @Data2 varbinary(max), @Length2 bigint, @Offset2 bigint,
    @Data3 varbinary(max), @Length3 bigint, @Offset3 bigint,
    @Data4 varbinary(max), @Length4 bigint, @Offset4 bigint,
    @Data5 varbinary(max), @Length5 bigint, @Offset5 bigint,
    @Data6 varbinary(max), @Length6 bigint, @Offset6 bigint,
    @Data7 varbinary(max), @Length7 bigint, @Offset7 bigint,
    @Data8 varbinary(max), @Length8 bigint, @Offset8 bigint,
    @Data9 varbinary(max), @Length9 bigint, @Offset9 bigint,
    @Data10 varbinary(max), @Length10 bigint, @Offset10 bigint,
    @Data11 varbinary(max), @Length11 bigint, @Offset11 bigint,
    @Data12 varbinary(max), @Length12 bigint, @Offset12 bigint,
    @Data13 varbinary(max), @Length13 bigint, @Offset13 bigint,
    @Data14 varbinary(max), @Length14 bigint, @Offset14 bigint,
    @Data15 varbinary(max), @Length15 bigint, @Offset15 bigint,
    @Data16 varbinary(max), @Length16 bigint, @Offset16 bigint,
    @Data17 varbinary(max), @Length17 bigint, @Offset17 bigint,
    @Data18 varbinary(max), @Length18 bigint, @Offset18 bigint,
    @Data19 varbinary(max), @Length19 bigint, @Offset19 bigint,
    @Data20 varbinary(max), @Length20 bigint, @Offset20 bigint,
    @Data21 varbinary(max), @Length21 bigint, @Offset21 bigint,
    @Data22 varbinary(max), @Length22 bigint, @Offset22 bigint,
    @Data23 varbinary(max), @Length23 bigint, @Offset23 bigint,
    @Data24 varbinary(max), @Length24 bigint, @Offset24 bigint,
    @Data25 varbinary(max), @Length25 bigint, @Offset25 bigint,
    @Data26 varbinary(max), @Length26 bigint, @Offset26 bigint,
    @Data27 varbinary(max), @Length27 bigint, @Offset27 bigint,
    @Data28 varbinary(max), @Length28 bigint, @Offset28 bigint,
    @Data29 varbinary(max), @Length29 bigint, @Offset29 bigint,
    @Data30 varbinary(max), @Length30 bigint, @Offset30 bigint,
    @Data31 varbinary(max), @Length31 bigint, @Offset31 bigint,
    @Data32 varbinary(max), @Length32 bigint, @Offset32 bigint,
    @Data33 varbinary(max), @Length33 bigint, @Offset33 bigint,

```

```

@Data34 varbinary(max), @Length34 bigint, @Offset34 bigint,
@Data35 varbinary(max), @Length35 bigint, @Offset35 bigint,
@Data36 varbinary(max), @Length36 bigint, @Offset36 bigint,
@Data37 varbinary(max), @Length37 bigint, @Offset37 bigint,
@Data38 varbinary(max), @Length38 bigint, @Offset38 bigint,
@Data39 varbinary(max), @Length39 bigint, @Offset39 bigint,
@Data40 varbinary(max), @Length40 bigint, @Offset40 bigint,
@Data41 varbinary(max), @Length41 bigint, @Offset41 bigint,
@Data42 varbinary(max), @Length42 bigint, @Offset42 bigint,
@Data43 varbinary(max), @Length43 bigint, @Offset43 bigint,
@Data44 varbinary(max), @Length44 bigint, @Offset44 bigint,
@Data45 varbinary(max), @Length45 bigint, @Offset45 bigint,
@Data46 varbinary(max), @Length46 bigint, @Offset46 bigint,
@Data47 varbinary(max), @Length47 bigint, @Offset47 bigint,
@Data48 varbinary(max), @Length48 bigint, @Offset48 bigint,
@Data49 varbinary(max), @Length49 bigint, @Offset49 bigint,
@Data50 varbinary(max), @Length50 bigint, @Offset50 bigint,
@Data51 varbinary(max), @Length51 bigint, @Offset51 bigint,
@Data52 varbinary(max), @Length52 bigint, @Offset52 bigint,
@Data53 varbinary(max), @Length53 bigint, @Offset53 bigint,
@Data54 varbinary(max), @Length54 bigint, @Offset54 bigint,
@Data55 varbinary(max), @Length55 bigint, @Offset55 bigint,
@Data56 varbinary(max), @Length56 bigint, @Offset56 bigint,
@Data57 varbinary(max), @Length57 bigint, @Offset57 bigint,
@Data58 varbinary(max), @Length58 bigint, @Offset58 bigint,
@Data59 varbinary(max), @Length59 bigint, @Offset59 bigint,
@Data60 varbinary(max), @Length60 bigint, @Offset60 bigint,
@Data61 varbinary(max), @Length61 bigint, @Offset61 bigint,
@Data62 varbinary(max), @Length62 bigint, @Offset62 bigint,
@Data63 varbinary(max), @Length63 bigint, @Offset63 bigint
)

```

@SiteId: The site collection identifier of the site collection containing the document.

@DocId: The document identifier (2) of the document.

@Partition: The stream partition that the new stream binary piece belongs to.

@BSN: The BLOB sequence number of the new stream binary piece.

@Size: The size, in bytes, of the new stream binary piece.

@Type: The stream (1) type of the new stream binary piece.

@Expiration: The timestamp in UTC format of the stream binary piece. If the stream binary piece does not have an expiration, this parameter MUST be NULL.

@Data[0-63]: A piece of the binary data for the stream binary piece. See definition for details of format.

@Length[0-63]: This value MUST be the the length of the corresponding **@Data** parameter, in bytes.

@Offset[0-63]: The offset in the stream binary piece where the corresponding **@Data** belongs. This value MUST be greater than or equal to zero, and this value plus the corresponding **@Length** parameter MUST be less than or equal to the total size of the new stream binary piece.

Return Values: The **proc_WriteStreamToSQL** stored procedure returns an integer return code which MUST be listed in the following table.

| Value | Description |
|-------|---|
| 0 | Successful execution. |
| 29 | Unexpected error. |
| 80 | A stream binary piece with the same BLOB sequence number or stream identifier already exists. |

The **proc_WriteStreamToSQL** stored procedure MUST NOT return a result set.

3.1.5.135 **proc_SetStreamsToDoc**

The **proc_SetStreamsToDoc** stored procedure associates stream binary pieces with a document.

```
PROCEDURE dbo.proc_SetStreamsToDoc (  
    @SiteId uniqueidentifier,  
    @DocId uniqueidentifier,  
    @HistVersion int,  
    @Level tinyint,  
    @Partition tinyint,  
    @StreamsToAdd tvpBSNMetadata READONLY,  
    @StreamsToDel tvpBSNMetadata READONLY,  
    @DeleteAllStreams bit,  
    @QuotaChange bigint = NULL OUTPUT  
)
```

@SiteId: The site collection identifier of the site collection containing the document.

@DocId: The document identifier (2) of the document.

@HistVersion: If the document is a historical version, this parameter MUST be the UI version number. Otherwise, this parameter MUST be zero.

@Level: The publishing level of the document.

@Partition: The stream partition to which the stream binary pieces belong.

@StreamsToAdd: Specifies the BLOB sequence number and stream identifier for the stream binary pieces to associate with the document.

@StreamsToDel: Specifies the BLOB sequence number for the stream binary pieces to unassociate with the document.

@DeleteAllStreams: If this parameter is one, all existing stream binary pieces MUST remove their association with the document.

@QuotaChange: An optional output parameter that specifies the quota change (negative value or zero), in bytes, of all the stream binary pieces that were unassociated from the document based on the **@StreamsToDel** and **@DeleteAllStreams** parameters.

Return Values: The **proc_SetStreamsToDoc** stored procedure returns an integer return code which MUST be listed in the following table.

| Value | Description |
|-------|--|
| 0 | Successful execution. |
| 29 | Unexpected error. |
| 80 | A stream binary piece with the same BLOB sequence number or stream identifier is already associated with the document. |

The **proc_SetStreamsToDoc** stored procedure MUST NOT return a result set.

3.1.5.136 proc_SetStreamsToDocNoTVP

The **proc_SetStreamsToDocNoTVP** stored procedure associates stream binary pieces with a document.

```

PROCEDURE dbo.proc_SetStreamsToDocNoTVP (
    @SiteId uniqueidentifier,
    @DocId uniqueidentifier,
    @HistVersion int,
    @Level tinyint,
    @Partition tinyint,
    @BSNToAdd0 bigint, @StreamIdToAdd0 bigint,
    @BSNToAdd1 bigint, @StreamIdToAdd1 bigint,
    @BSNToAdd2 bigint, @StreamIdToAdd2 bigint,
    @BSNToAdd3 bigint, @StreamIdToAdd3 bigint,
    @BSNToAdd4 bigint, @StreamIdToAdd4 bigint,
    @BSNToAdd5 bigint, @StreamIdToAdd5 bigint,
    @BSNToAdd6 bigint, @StreamIdToAdd6 bigint,
    @BSNToAdd7 bigint, @StreamIdToAdd7 bigint,
    @BSNToAdd8 bigint, @StreamIdToAdd8 bigint,
    @BSNToAdd9 bigint, @StreamIdToAdd9 bigint,
    @BSNToAdd10 bigint, @StreamIdToAdd10 bigint,
    @BSNToAdd11 bigint, @StreamIdToAdd11 bigint,
    @BSNToAdd12 bigint, @StreamIdToAdd12 bigint,
    @BSNToAdd13 bigint, @StreamIdToAdd13 bigint,
    @BSNToAdd14 bigint, @StreamIdToAdd14 bigint,
    @BSNToAdd15 bigint, @StreamIdToAdd15 bigint,
    @BSNToAdd16 bigint, @StreamIdToAdd16 bigint,
    @BSNToAdd17 bigint, @StreamIdToAdd17 bigint,
    @BSNToAdd18 bigint, @StreamIdToAdd18 bigint,
    @BSNToAdd19 bigint, @StreamIdToAdd19 bigint,
    @BSNToAdd20 bigint, @StreamIdToAdd20 bigint,
    @BSNToAdd21 bigint, @StreamIdToAdd21 bigint,
    @BSNToAdd22 bigint, @StreamIdToAdd22 bigint,
    @BSNToAdd23 bigint, @StreamIdToAdd23 bigint,
    @BSNToAdd24 bigint, @StreamIdToAdd24 bigint,
    @BSNToAdd25 bigint, @StreamIdToAdd25 bigint,
    @BSNToAdd26 bigint, @StreamIdToAdd26 bigint,
    @BSNToAdd27 bigint, @StreamIdToAdd27 bigint,
    @BSNToAdd28 bigint, @StreamIdToAdd28 bigint,
    @BSNToAdd29 bigint, @StreamIdToAdd29 bigint,
    @BSNToAdd30 bigint, @StreamIdToAdd30 bigint,
    @BSNToAdd31 bigint, @StreamIdToAdd31 bigint,
    @BSNToDelete0 bigint,
    @BSNToDelete1 bigint,
    @BSNToDelete2 bigint,
    @BSNToDelete3 bigint,

```

```

    @BSNToDelete4 bigint,
    @BSNToDelete5 bigint,
    @BSNToDelete6 bigint,
    @BSNToDelete7 bigint,
    @BSNToDelete8 bigint,
    @BSNToDelete9 bigint,
    @BSNToDelete10 bigint,
    @BSNToDelete11 bigint,
    @BSNToDelete12 bigint,
    @BSNToDelete13 bigint,
    @BSNToDelete14 bigint,
    @BSNToDelete15 bigint,
    @BSNToDelete16 bigint,
    @BSNToDelete17 bigint,
    @BSNToDelete18 bigint,
    @BSNToDelete19 bigint,
    @BSNToDelete20 bigint,
    @BSNToDelete21 bigint,
    @BSNToDelete22 bigint,
    @BSNToDelete23 bigint,
    @BSNToDelete24 bigint,
    @BSNToDelete25 bigint,
    @BSNToDelete26 bigint,
    @BSNToDelete27 bigint,
    @BSNToDelete28 bigint,
    @BSNToDelete29 bigint,
    @BSNToDelete30 bigint,
    @BSNToDelete31 bigint,
    @DeleteAllStreams bit,
    @QuotaChange bigint = NULL OUTPUT
)

```

@SiteId: The site collection identifier of the site collection containing the document.

@DocId: The document identifier (2) of the document.

@HistVersion: If the document is a historical version, this parameter MUST be the UI version number. Otherwise, this parameter MUST be zero.

@Level: The publishing level of the document.

@Partition: The stream partition to which the stream binary pieces belong.

@BSNToAdd[0-31]: The BLOB sequence number of the stream binary pieces to associate with the document.

@StreamIdToAdd[0-31]: The stream identifiers of the stream binary pieces to associate with the document. The position of the stream identifier in **@StreamIdToAdd** MUST match the position of the BLOB sequence number in **@BSNToAdd**.

@BSNToDelete[0-31]: The BLOB sequence number of the stream binary pieces to unassociate with the document.

@DeleteAllStreams: If this parameter is one, all existing stream binary pieces MUST remove their association with the document.

@QuotaChange: An optional output parameter that specifies the sum, in bytes, of all the stream binary pieces that were unassociated from the document based on the *@BSNToDelete[0-31]* and *@DeleteAllStreams* parameters.

Return Values: The **proc_SetStreamsToDocNoTVP** stored procedure returns an integer return code which MUST be listed in the following table.

| Value | Description |
|-------|--|
| 0 | Successful execution. |
| 29 | Unexpected error. |
| 80 | A stream binary piece with the same BLOB sequence number or stream identifier is already associated with the document. |

The **proc_SetStreamsToDocNoTVP** stored procedure MUST NOT return a result set.

3.1.5.137 TVF_Docs_Url_Level

The **TVF_Docs_Url_Level** table value function is invoked to return a subset of rows from the Docs view (section [2.2.6.3](#)).

```
FUNCTION [dbo].[TVF_Docs_Url_Level]
(
    @SiteId uniqueidentifier,
    @DirName nvarchar(256),
    @LeafName nvarchar(128),
    @Level tinyint
)
```

@SiteId: All the rows returned from the Docs view MUST have **SiteId** = *@SiteId*.

@DirName: All the rows returned from the Docs view MUST have **DirName** = *@DirName*.

@LeafName: All the rows returned from the Docs view MUST have **LeafName** = *@LeafName*.

@Level: All the rows returned from the Docs view MUST have **Level** = *@Level*.

Return Values: **TVF_Docs_Url_Level** returns all rows from the Docs view that are specified as follows.

```
(SiteId = @SiteId AND DeleteTransactionId = 0x AND DirName = @DirName AND LeafName =
@LeafName AND Level = @Level.)
```

3.1.5.138 TVF_UserData_ListItemLevelRow

The **TVF_UserData_ListItemLevelRow** table value function is invoked to return a subset of rows from the **UserData View** (section [2.2.6.8](#)).

```
FUNCTION [dbo].[TVF_UserData_ListItemLevelRow]
(
    @tp_SiteId uniqueidentifier,
    @tp_ListId uniqueidentifier,
```

```

        @tp_Id int,
        @tp_Level tinyint,
        @tp_RowOrdinal tinyint
    )

```

@tp_SiteId: All the rows returned from the **UserData View** (section [2.2.6.8](#)) MUST have **tp_SiteId** = @tp_SiteId.

@tp_ListId: All the rows returned from the **UserData View** (section [2.2.6.8](#)) MUST have **tp_ListId** = @tp_ListId.

@tp_Id: All the rows return from the **UserData View** (section [2.2.6.8](#)) MUST have **tp_Id** = @tp_Id.

@tp_Level: All the rows return from the **UserData View** (section [2.2.6.8](#)) MUST have **tp_Level** = @tp_Level.

@tp_RowOrdinal: All the rows returned from the **UserData View** (section [2.2.6.8](#)) MUST have **tp_RowOrdinal** = @tp_RowOrdinal.

Return Values: **TVF_UserData_ListItemLevelRow** (section [3.1.5.137](#)) returns all rows from the **UserData View** (section [2.2.6.8](#)) that are specified as follows.

```

(tp_SiteId = @tp_SiteId AND tp_ListId = @tp_ListId AND tp_DeleteTransactionId = 0x AND
tp_IsCurrentVersion = CONVERT(bit, 1) AND tp_Id = @tp_Id AND tp_CaculatedVersion = 0 AND
tp_Level = @tp_Level AND tp_RowOrdinal = @tp_RowOrdinal)

```

3.1.5.139 TVF_UserData_PId_DId_Level_Row

The **TVF_UserData_PId_DId_Level_Row** table value function is invoked to return a subset of rows from the **UserData View** (section [2.2.6.8](#)).

```

FUNCTION [dbo].[TVF_UserData_PId_DId_Level_Row]
(
    @tp_SiteId uniqueidentifier,
    @tp_ParentId uniqueidentifier,
    @tp_DocId uniqueidentifier,
    @tp_Level tinyint,
    @tp_RowOrdinal tinyint
)

```

@tp_SiteId: All the rows returned from the **UserData View** MUST have **tp_SiteId** = @tp_SiteId.

@tp_ParentId: All the rows returned from the **UserData View** MUST have **tp_ParentId** = @tp_ParentId.

@tp_DocId: All the rows returned from the **UserData View** MUST have **tp_DocId** = @tp_DocId.

@tp_Level: All the rows returned from the **UserData View** MUST have **tp_Level** = @tp_Level.

@tp_RowOrdinal: All the rows returned from the **UserData View** MUST have **tp_RowOrdinal** = @tp_RowOrdinal.

Return Values: **TVF_UserData_PId_DId_Level_Row** returns all rows from the **UserData View** that are specified as follows.

```
(tp_SiteId = @tp_SiteId AND tp_DeleteTransactionId = 0x AND tp_IsCurrentVersion =  
CONVERT(bit, 1) AND tp_ParentId = @tp_ParentId AND tp_DocId = @tp_DocId AND  
tp_CalculatedVersion = 0 AND tp_Level = @tp_Level AND tp_RowOrdinal = @tp_RowOrdinal)
```

3.1.5.140 proc_HasCurrentPublishVersion

The **proc_HasCurrentPublishVersion** stored procedure is invoked to test whether the specified list item has a current published version.

```
PROCEDURE proc_HasCurrentPublishVersion (  
    @SiteId            uniqueidentifier,  
    @ListId            uniqueidentifier,  
    @ItemId            int,  
    @RequestGuid       uniqueidentifier = null OUTPUT  
);
```

@SiteId: The site collection identifier of the site collection.

@ListId: The list identifier of the list that contains the specified list item.

@ItemId: The list item identifier of the specified list item.

@RequestGuid: The optional request identifier for the current request.

Return values: This stored procedure returns an integer return code, which MUST be included in the following table.

| Value | Description |
|-------|--|
| 0 | The specified list item does not have a current published version. |
| 1 | The specified list item has a current published version. |

This stored procedure MUST NOT return a result set.

3.1.5.141 proc_GetSiteDenyPermMask

The **proc_GetSiteDenyPermMask** stored procedure is invoked to return a **WSS Rights Mask** (section [2.2.2.15](#)) specifying the rights to deny to the current user in the specified site collection.

```
PROCEDURE proc_GetSiteDenyPermMask (  
    @SiteId            uniqueidentifier,  
    @RequestGuid       uniqueidentifier = NULL OUTPUT  
);
```

@SiteId: The Site Collection Identifier (section [2.2.1.1.9](#)) of the site collection for which to retrieve the deny rights mask.

@RequestGuid: The optional request identifier for the current request.

Return Values: This stored procedure MUST return an integer return code of 0.

This stored procedure MUST return the following result set.

3.1.5.141.1 Deny Permissions Mask Result Set

The **Deny Permissions Mask Result Set** returns a **WSS Rights Mask** (section [2.2.2.15](#)) specifying the rights to deny to the current user in the specified site collection.

```
{DenyPermMask}          tPermMask;
```

{DenyPermMask}: A **WSS Rights Mask** (section [2.2.2.15](#)) specifying the rights to deny to the current user.

3.1.5.142 proc_GetNewListItemId

The **proc_GetNewListItemId** stored procedure is called to get the next available row identifier of a list (1) and the number of rows that will be copied or moved when copying or moving a URL to that list (1). The T-SQL syntax for the stored procedure is as follows:

```
PROCEDURE proc_GetNewListItemId(  
    @SiteId                uniqueidentifier,  
    @FullUrl               nvarchar(260),  
    @NewListId             uniqueidentifier,  
    @bIsCopy               bit,  
    @NewDoclibRowId        int OUTPUT,  
    @MaxNewRows            int OUTPUT  
);
```

@SiteId: The site collection identifier of the site collection which contains the URL specified by **@FullUrl**.

@FullUrl: The full URL to copy or move.

@NewListId: The list identifier of the target list.

@bIsCopy: A bit flag that indicates whether to copy or move the URL specified by **@FullUrl**. The value MUST be 1 to copy or MUST be zero to move.

@NewDocLibRowId: This is an output parameter whose value indicates the next available row identifier in the target list (1) where the URL specified by **@FullUrl** is being copied or moved to. The return value MUST be obtained by calling **proc_GenerateNextId** when the URL specified by **@FullUrl** is a file or folder; otherwise is undefined.

@MaxNewRows: This is an output parameter whose value indicates the total number of items as specified by **@FullUrl** that will be copied or moved. The return value MUST be 1 if the URL specified by **@FullUrl** is a file; MUST be the number of items contained in the folder if the URL specified by **@FullUrl** is a folder; otherwise is undefined.

Return values: An integer that MUST be zero.

3.1.5.143 proc_UpdateDiskUsed

The **proc_UpdateDiskUsed** stored procedure is called to update the disk-used size, in Bytes, of a site collection.

The T-SQL syntax for the stored procedure is as follows.

```
PROCEDURE proc_UpdateDiskUsed (  
    @SiteId                uniqueidentifier,  
    @bUpdateTimeStampForce bit = 0  
);
```

@SiteId: The site collection identifier of the site collection whose disk-used size is to update.

@bUpdateTimeStampForce: A bit flag specifying whether to update the time stamp of **LastContentChange** of the site collection. If the value is 1, **LastContentChange** of the site collection MUST be updated with the current time. If the value is 0, **LastContentChange** MUST be unmodified.

Return Code Values: This stored procedure MUST return 0 upon completion.

Result Sets: MUST NOT return any result sets.

3.1.6 Timer Events

If the execution timeout event (2) is triggered, then the execution of the stored procedure is terminated and the call fails.

3.1.7 Other Local Events

None.

3.2 Web Front End Client Details

The front-end Web server acts as a client when it calls the back-end database server requesting execution of stored procedures.

3.2.1 Abstract Data Model

This section describes a conceptual model of possible data organization that an implementation maintains to participate in this protocol. The described organization is provided to facilitate the explanation of how the protocol behaves. This document does not mandate that implementations adhere to this model as long as their external behavior is consistent with that described in this document.

The front-end Web server can maintain the following sets of data for this protocol within object structures. There is no requirement for the data within these structures to be a complete representation of all data maintained on the back-end database server, but can be populated as various requests to the back-end database server are fulfilled. Data maintained on the front-end Web server can be discarded after individual sequences of requests have completed as part of a response for a higher level event.

- Configuration
- Site Collections
- Sites
- Lists
- List Items

- Documents
- Users
- Groups

3.2.2 Timers

A connection timeout timer is set up on the front-end Web server to govern the total connection time for any requests to the back-end database server. The amount of time is governed by a timeout value configured on the front-end Web server for all back-end database server connections.

3.2.3 Initialization

The front-end Web server MUST validate the user making the request before calling the stored procedure(s). The Site Collection Identifier and the User Identifier for the user making the request are looked up by the front-end Web server before calling additional stored procedure(s).

3.2.4 Higher-Layer Triggered Events

None.

3.2.5 Message Processing Events and Sequencing Rules

The front-end Web server handles each stored procedure with the same processing method of calling the stored procedure and waiting for the result code and any result sets that will be returned.

The front-end Web server can execute dynamically generated SQL queries against the stored procedures or the tables and views used within the database. However, unless otherwise specified, any data addition, removal, or modification MUST occur only by calling the listed stored procedure. SQL queries MUST NOT attempt to add, remove, or update data in any table or view in the content databases or configuration database (section [3.1.1](#)), unless explicitly described in this section.

3.2.6 Timer Events

If the connection timeout event (2) is triggered, the connection and the stored procedure call fails.

3.2.7 Other Local Events

None.

4 Protocol Examples

This section provides specific example scenarios for end-to-end file and permissions management against WSS. These examples describe in detail the process of communication between the various server components involved in the WSS deployment. In conjunction with the detailed protocol documentation described in the reference documents, this information is intended to provide a comprehensive view of how WSS front-end Web server communicates with both EUC and BEDS systems.

4.1 File: Open File OM

This example describes the requests and responses made when the front-end Web server opens an existing file stored as a document in a document library on the BEDS with a SharePoint Object Model call.

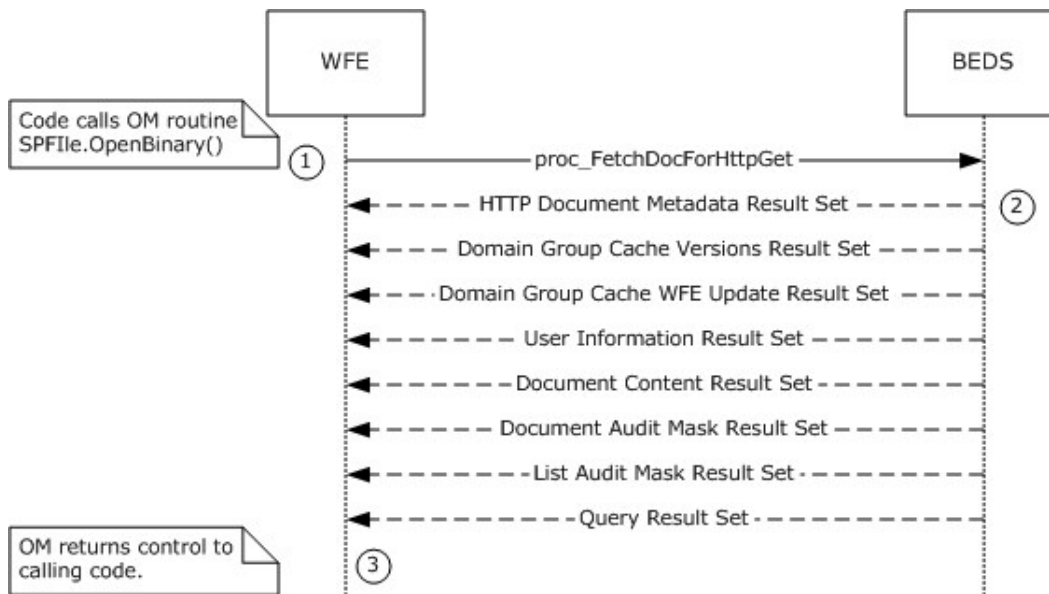

Figure 2: File: Open File OM

This scenario is initiated by a call to the **Microsoft.SharePoint.SPFile.OpenBinary()** object model command. For simplicity's sake, this example assumes that the file is stored as a document in a document library, and that the requested version is a draft created by the same user who is opening the file. This example assumes that:

- The code has already instantiated the site collection (SPSite), Site (SPWeb), and document library (SPList) objects containing the document to be opened.
- Auditing is disabled for the site collection.
- The current user has File Open permissions for the document.
- sitegroups in the site collection do not include any domain groups as members (1).

The following actions happen:

1. The WFE builds a dynamic query that invokes the **proc_FetchDocForHttpGet** stored procedure.

2. The BEDS returns a return code of 0, and returns the following result sets:

- **HTTP Document Metadata Result Set** (section [3.1.5.19.1](#)). This returns the document metadata needed to further process the document.
- **Domain Group Cache Versions Result Set** (section [2.2.4.4](#)). The versions of the Domain Group cache on BEDS and WFE, used to determine if either the BEDS or WFE has more up-to-date information about external group membership in Roles, which are stored as site groups.
- **Domain Group Cache WFE Update Result Set** (section [2.2.4.5](#)). Used to update the WFE's external group map cache if needed. Under our assumptions, this result set is empty, because no domain groups are members of any roles in the site collection.
- **User Information Result Set** (section [3.1.5.19.5](#)). Used to establish that the current user has permissions to open the file.
- **Document Content Stream Result Set** (section [3.1.5.19.9](#)). Includes the document stream containing the binary file content for the current version of the document visible to the user, along with additional document metadata.
- **Site Audit Mask Result Set** (section [2.2.4.22](#)). Under our assumptions, auditing is not enabled on the site collection, so the **SiteGlobalAuditMask** column is NULL.
- **List Audit Mask Result Set** (section [3.1.5.19.11](#)), containing auditing information for the document's containing document library. Under our assumptions, auditing is not enabled for the site collection, so the fields containing audit masks are NULL.
- A **Dynamic Query Result Set** containing a single row with a single unnamed column, holding the value of the *@Level* output parameter from the stored procedure **proc_FetchDocForHttpGet**. The value is 2, indicating that the content returned is from the latest draft version.

3. The OM returns control to the calling program with the array of bytes for the document stream of the requested file.

4.1.1 Determine a User's Permission Level to a Document

This example describes the requests made to determine a user's permissions on a document in a document library.

This example assumes:

- The user is authenticated and not anonymous.
- The user is a member of a role defined on the site.
- The document exists in a document library.

This scenario is initiated by a call to the object model command **SPListItem.EffectiveBasePermissions()**.

The following actions happen:

1. The WFE builds a dynamic query that invokes the **proc_FetchDocForHttpGet** stored procedure.
2. The BEDS returns a return code of 0, and returns a number of result sets, including the **HTTP Document Metadata Result Set** (section [3.1.5.19.1](#)). The **HTTP Document Metadata Result Set** contains an ACL which specifies the permissions on this document.

- The OM returns control to the calling program with the **SPBasePermissions** object containing the permissions the current user has on the requested document.

4.2 Group Add User to Site Group OM

This example describes the requests made when a user is added to a site group using SharePoint Object Model code running on the WFE.

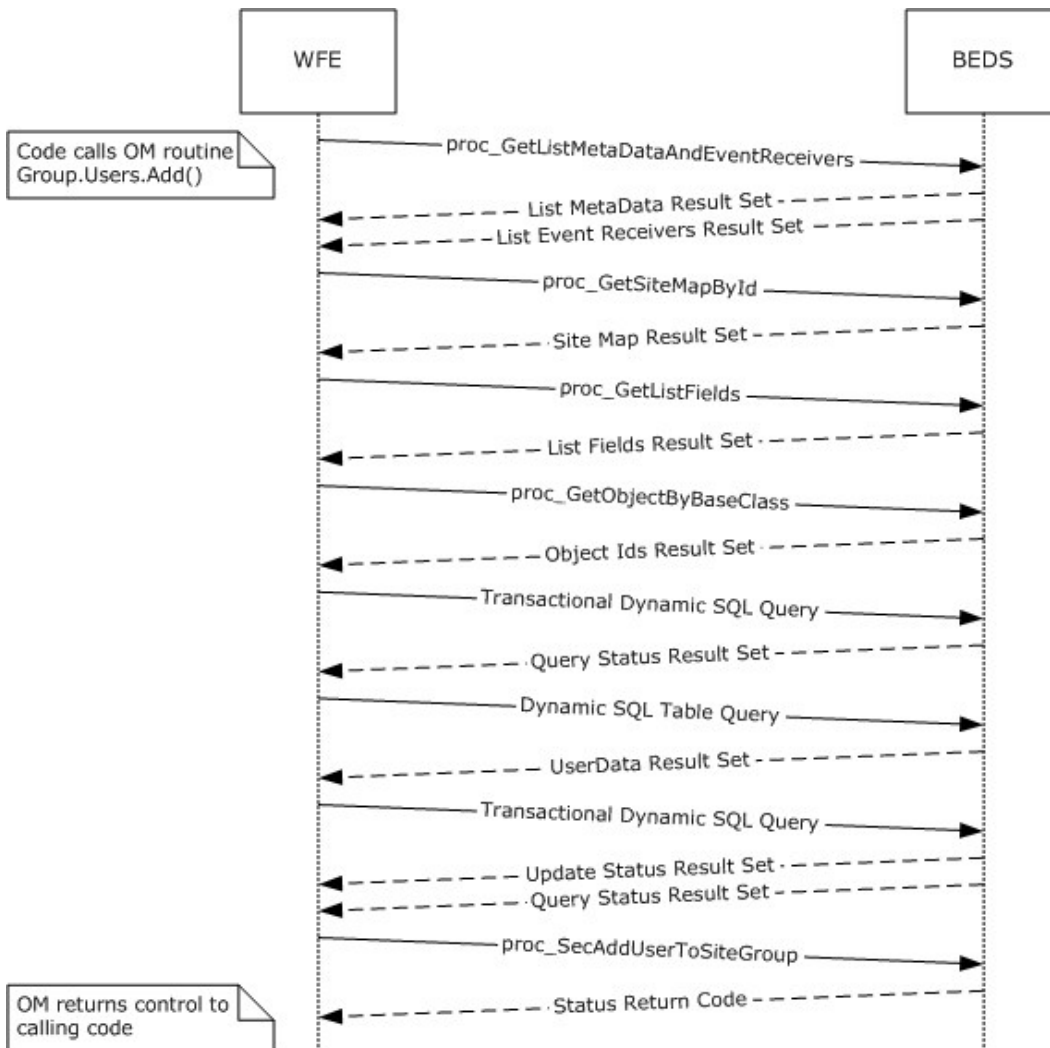

Figure 3: Group Add User To Site Group OM

This scenario is initiated by a call to the object model command **SPGroup.Users.Add()**. For simplicity's sake, this example assumes that:

- The code has already instantiated the site collection (SPSite), Web (SPWeb), and Group (SPGroup) objects, which contain the site group for this session.
- The instantiated objects have not yet populated information about the user information list.
- The user to be added to the group is currently a user in the site collection.

The following actions happen:

1. The WFE first fetches the properties for the "User Information List" of the target site collection, a SharePoint list that contains information about users and groups (2) registered in a site collection. It does this by calling the stored procedure **proc_GetListMetaDataAndEventReceivers** (section [3.1.5.33](#)) using TDS.
2. The BEDS returns two result sets, which include the **List Metadata** (section [2.2.4.14](#)) and **Event Receivers** (section [2.2.4.11](#)) for the specified user information list.
3. The WFE determines the site map for the site collection by calling the configuration database stored procedure **proc_getSiteMapById** (section [3.1.5.39](#)) using TDS.
4. The BEDS returns a single **Site Map By Id Result Set** (section [3.1.5.39.1](#)), which includes the site map for the specified site collection.
5. If the WFE determines that the user information list has not been populated in the current **SPSite** object, it requests the list field information for the site collection's user information list by calling the **proc_GetListFields** (section [3.1.5.32](#)) stored procedure using TDS.
6. The BEDS returns a single **Fields Information Result Set** (section [3.1.5.32.1](#)), which includes the field information for the specified user information list.
7. If the WFE determines that it needs to populate the list of **SPFeatures**, the list of child objects that inherit from the base class **SPFeatureDefinition** will be populated by calling the configuration database stored procedure **proc_getObjectsByBaseClass** (section [3.1.5.35](#)) using TDS.
8. The BEDS returns a single **Object ID Result Set** (section [2.2.4.18](#)), which includes a list of child object identifiers for the specified base class and parent object.
9. The WFE builds a transactional dynamic SQL query to add the user to the site collection and add the user's property information to the user information list. This query is sent to the SQL server using TDS. On the SQL server the following actions occur:
 - The query begins a new SQL transaction.
 - The query attempts to add the user to the site collection using the stored procedure **proc_SecAddUser** (section [3.1.5.51](#)).
 - The query checks if the user exists in the site collection's user information list.
 - If the user is not found in the site collection's user information list, the query attempts to add the user's properties to the site collection's user information list using the stored procedure **proc_AddListItem** (section [3.1.5.4](#)).
 - The query rolls back the SQL transaction if the previous procedures were not successful, or it commits the transaction if they were successful.
10. The BEDS returns a single result set indicating the status of the actions within the query and the output parameters from the **proc_SecAddUser** command.
11. The WFE queries the list of users in the user information list for the site collection by building a SQL Batch call to the **UserData View** (section [2.2.6.8](#)), which is then sent to the SQL server using TDS.
12. The BEDS returns a single result set with a list of items in the **UserData View**.

13. The WFE builds a transactional dynamic SQL query to add or update the list item that represents the user with the user's properties. This query is sent to the SQL server using TDS. On the SQL server the following actions occur:
 - The query begins a new SQL transaction.
 - The query checks if the user exists in the user information list for the site collection.
 - If the user is not found in the user information list for the site collection, then the query attempts to add the user's properties to the site collection's user information list using the stored procedure **proc_AddListItem**.
 - Otherwise, if the user is found in the site collection's user information list, the query attempts to update the user's properties in the site collection's user information list using the stored procedure **proc_UpdateListItem** (section [3.1.5.127](#)).
 - The query rolls back the SQL transaction if the previous procedures were not successful, or it commits the transaction if they were successful.
14. The BEDS returns two result sets, which contain the output and return codes from the **Add List Item** or **Update List Item** commands.
15. The WFE adds the user to the specified site group by calling the stored procedure **proc_SecAddUserToSiteGroup** (section [3.1.5.52](#)) using TDS.
16. The BEDS supplies a return code indicating success or failure of the procedure.

4.3 Group Update Site Group Properties OM

This example describes the interactions made when properties are updated for a particular site group.

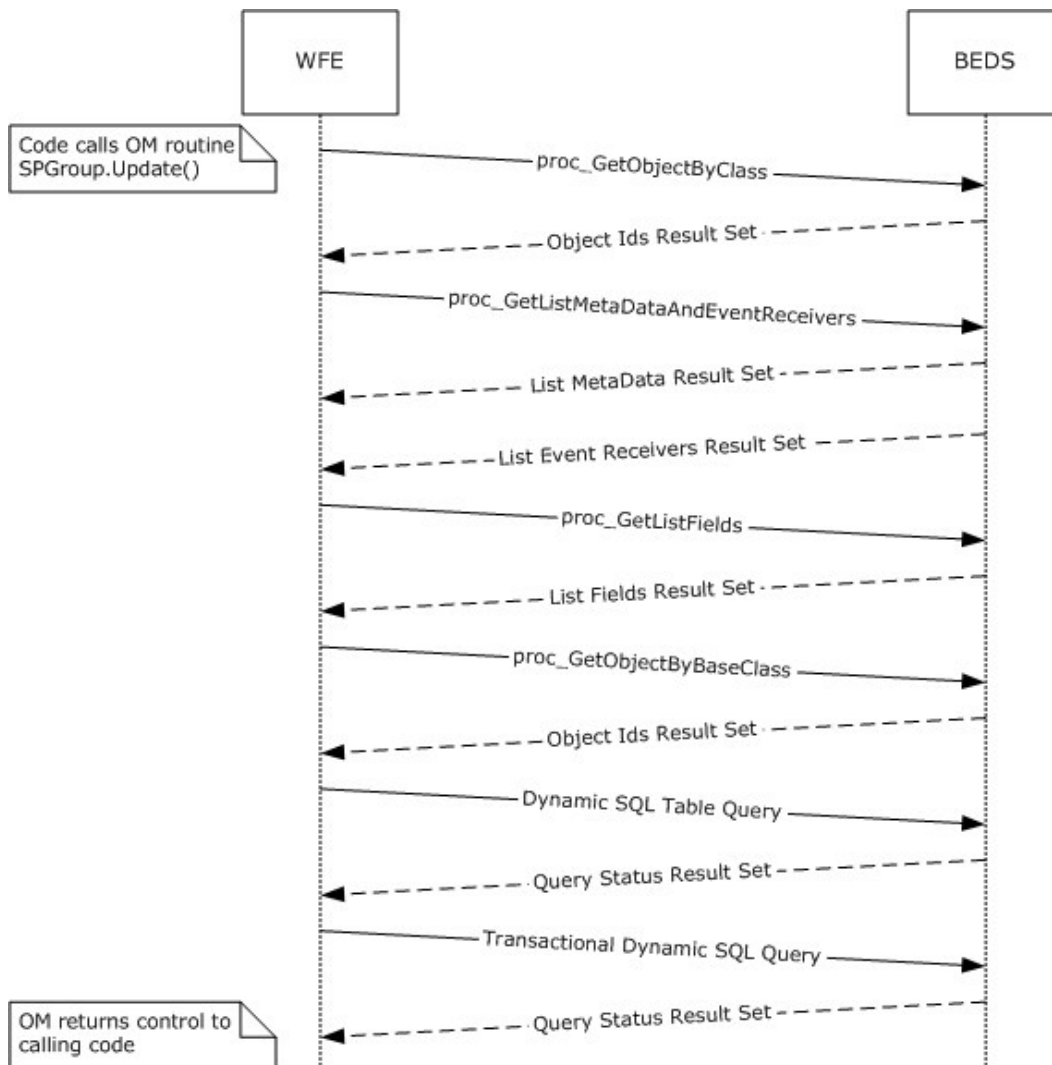

Figure 4: Group Update Site Group Properties OM

This scenario is initiated by a call to the object model command **SPGroup.Update()**. For simplicity's sake, this example assumes that:

- the code has already instantiated the site collection (**SPSite**) and site (**SPWeb**) objects for this session.
- the site group to be updated is in the site collection and is a member of the site.

The following actions happen:

1. The WFE determines if the site has the directory management service enabled with a call to the Configuration Database stored procedure **proc_GetObjectsByClass** (section [3.1.5.36](#)) using TDS.
2. The BEDS returns a single **Object ID Result Set** (section [2.2.4.18](#)) row, which includes a value set if the directory management service is enabled.

3. The WFE fetches the properties for the target site collection's user information list, a SharePoint list containing information about users and groups (2) registered in a site collection. It does this by calling the stored procedure **proc_GetListMetaDataAndEventReceivers** using TDS.
4. The BEDS returns two result sets, which include the **List Metadata** (section [2.2.4.14](#)) and **Event Receivers** (section [2.2.4.11](#)) for the specified user information list.
5. If the WFE determines that the user information list has not been populated in the current SPSite object, it requests the list field information for the site collection's user information list by calling the **proc_GetListFields** stored procedure using TDS.
6. The BEDS returns a single **Field Information Result Set**, which includes the field information for the specified user information list.
7. If the WFE determines that it needs to populate the list of **SPFeatures**, the list of child objects that inherit from the base class **SPFeatureDefinition** is populated by calling the configuration database stored procedure **proc_getObjectsByBaseClass** using TDS.
8. The BEDS returns a single **Object ID Result Set**, which includes a list of child object identifiers for the specified base class and parent object.
9. The WFE builds a dynamic SQL query to select existing information for the site group using TDS.
10. The BEDS returns a single result set, which includes existing data for the user.
11. The WFE builds a transactional dynamic SQL query to update the site group information in the site collection. This query is sent to the SQL server using TDS. On the SQL server the following actions occur:
 - The query begins a new SQL transaction.
 - The query attempts to load the site group information using the stored procedure **proc_SecSetSiteGroupProperties** (section [3.1.5.115](#)).
 - If the site group is not in the list of site members (1), the query invokes **proc_AddListItem** with the updated information.
 - Otherwise, the query attempts to update the site group's properties in the site collection user information list, using the stored procedure **proc_UpdateListItem** (section [3.1.5.127](#)).
 - The query rolls back the SQL transaction if the previous procedures were not successful, or it commits the transaction if they were successful.
12. The BEDS returns a single result set, which indicates the return code status of the actions within the query.

4.4 Security: Add User to Document Library via Object Model

This example describes the requests made when a user is added to the "contributor" role of a document library that has its own scope for independently managed permissions.

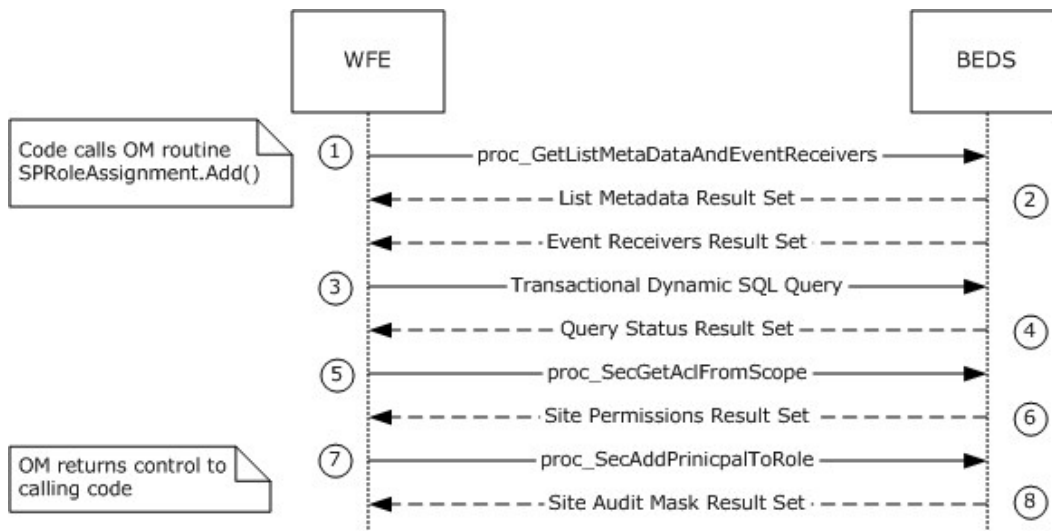

Figure 5: Add User to Document Library via Object Model

This scenario is initiated by a call to the object model command **SPRoleAssignmentCollection.Add(SPRoleAssignment)**.

For simplicity's sake, this example assumes that the code has already instantiated the necessary site collection (**SPSite**), site (**SPWeb**), and list (**SPList**) objects, as well as the role (**SPRoleDefinition**), role bindings (**SPRoleDefinitionBindingCollection**) and role assignment (**SPRoleAssignment**) objects, to construct a representation of the role within the document library to which the user will be added.

1. The WFE first fetches the properties for the user information list of the site collection. The user information list is a SharePoint list containing information about users in the site collection. It does this by calling the stored procedure **proc_GetListMetaDataAndEventReceivers** (section [3.1.5.33](#)) using TDS.
2. The BEDS returns two result sets. The **List Metadata Result Set** returns a single row of data with the metadata for the list. The second result set is the **Event Receivers Result Set** (section [2.2.4.11](#)). In this example, there are no registered event receivers, and so zero rows are returned.
3. The WFE builds a transactional dynamic SQL query to add the user to the document library's "Contributor" role and to add or update the user's property information in the user information list. This query is sent to the SQL server using TDS. On the SQL server, the following actions occur:
 - The query begins a new SQL transaction.
 - The query attempts to add the user to the site collection's user information list using the stored procedure **proc_SecAddUser** (section [3.1.5.51](#)).
 - The query checks if the user exists in the site collection's user information list.
 - If the user is not found in the site collection's user information list, then the query attempts to add the user's properties to the site collection's user information list using the stored procedure **proc_AddListItem**.

- The query rolls back the SQL transaction if the previous procedures were not successful, or it commits the transaction if they were successful.
4. The BEDS returns a single result set indicating the status of the actions within the query and the output parameters from the **proc_SecAddUser** stored procedure.
 5. The WFE fetches the list's scope ACL and anonymous user permission information by calling the stored procedure **proc_SecGetAclFromScope** (section [3.1.5.62](#)) using TDS.
 6. The BEDS returns an ACL and Permissions Result Set (section [2.2.4.1](#)), which lists ACL and permission information for the list's scope.
 7. The WFE adds the user to the list's "contributor" role assignment membership site group by calling the stored procedure **proc_SecAddPrincipalToRole** (section [3.1.5.49](#)) using TDS.
 8. The BEDS returns a **Site Audit Mask Result Set** (section [2.2.4.22](#)), which lists **Auditing Flags** information for the site collection and document library.

4.5 Security: Break Web Inheritance OM

This example describes the requests made to create unique security role assignments for a site, rather than inheriting them from a parent.

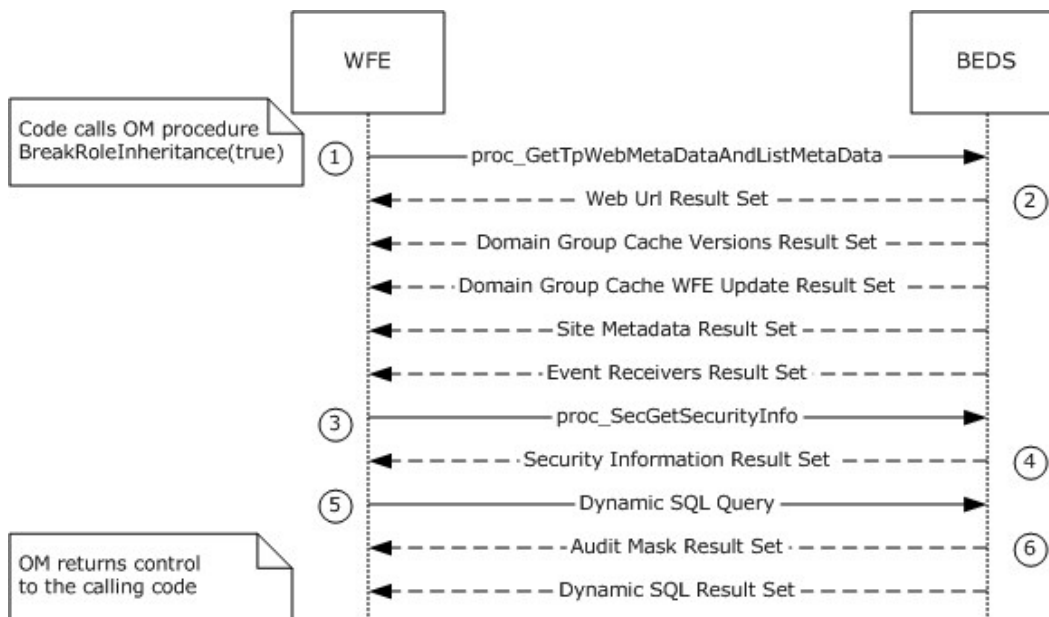

Figure 6: Break Web Inheritance OM

This scenario is initiated by a call to the object model command **spweb.BreakRoleInheritance(true)**. For simplicity's sake, this example assumes that:

- the code has already instantiated the site collection (**SPSite**), the parent site and child subsite (**SPWeb**) objects for this session, and
- the child subsite is initially in the same scope as its parent site.

The following actions happen:

1. The WFE first retrieves metadata for the requested child site. It does this by calling the **proc_GetTpWebMetaDataAndListMetaData** (section [3.1.5.40](#)) stored procedure using TDS.
2. The BEDS returns the following five result sets:
 - **Web URL Result Set** (section [3.1.5.40.1](#)). This contains the store-relative form URL of the root of the requested child site.
 - **Domain Group Cache Versions Result Set** (section [2.2.4.4](#)). This contains information about the version numbers associated with the External Group Map Cache for the requested site.
 - **Domain Group Cache WFE Update Result Set** (section [2.2.4.5](#)). This returns the binary data needed to refresh the external group Map Cache.
 - **Site Metadata Result Set** (section [2.2.4.24](#)). This contains metadata for the requested site.
 - **Event Receivers Result Set** (section [2.2.4.11](#)). This contains information about the event receivers defined for the requested site.
3. The WFE then retrieves security permissions information about the requested site. It does this by calling the **proc_SecGetSecurityInfo** (section [3.1.5.83](#)) stored procedure using TDS.
4. The BEDS returns the **Security Information Result Set** (section [3.1.5.83.1](#)), which consists of information about security permissions about the requested site.
5. The WFE then builds a Dynamic SQL Query to convert the requested site to use unique permissions (as opposed to inheriting those permission from the Parent site). It does this by calling the **proc_SecChangeToUniqueScope** (section [3.1.5.56](#)) stored procedure using TDS.
6. The BEDS returns the following two result sets:
 - **SiteAudit Mask Result Set** (section [2.2.4.22](#)), containing information about the Audit Flags (section [2.2.2.1](#)) set for the requested child site.
 - A Dynamic SQL Result Set, containing the Scope Identifier (section [2.2.1.1.8](#)) of the new scope generated for the child site.

4.6 Site Collection Lookup

To allow SharePoint's data storage to scale out, site collections can be stored in many content databases. This example illustrates the protocol operations between the client (front-end Web server) and server (back-end database server) needed to find and connect to a specific content database given a site collection URL. An existing connection to the configuration database using lower-level protocols is assumed.

4.6.1 Retrieving the Farm Id

The example begins by calling **proc_GetObjectsByClass** (section [3.1.5.36](#)) with the **Farm Class ID**.

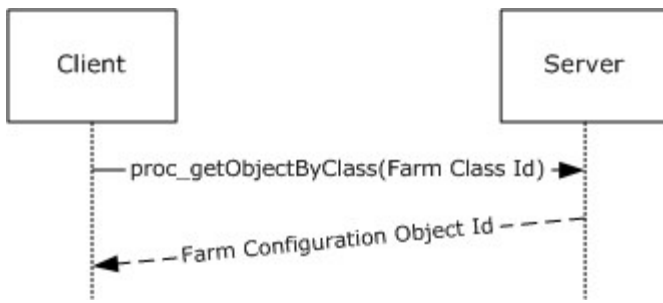

Figure 7: Retrieving the Farm ID

This call returns a result set including the **Configuration Object ID** of the Farm Configuration Object. **proc_getObjectsByClass** can return result sets with multiple rows, but this implementation of the protocol only ever stores one configuration object (section [2.2.5.1](#)) with the **Farm Class ID** and ignores all but the first row if multiple rows are returned.

4.6.2 Retrieving the Alternate URL Collection Ids

Next, the **Farm Configuration Object Id** and the **Alternate URL Collection Class Id** are passed to **proc_getObjectsByBaseClass**.

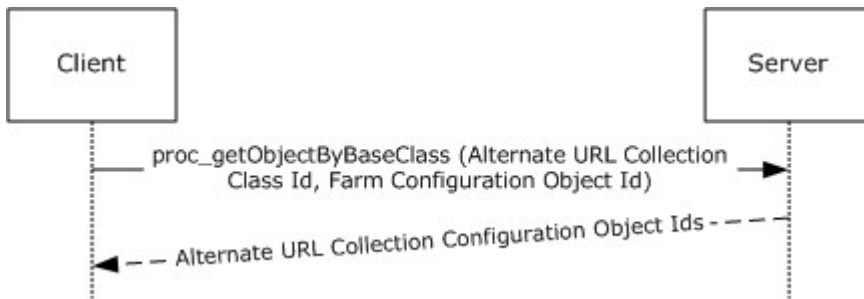

Figure 8: Web Service Lookup Operations

Because the implementation defined the returned Farm Configuration Object to be the Parent of all Alternate URL Collections, this call returns the **Configuration Object Ids** of all Alternate URL Collections stored in the Configuration Database.

4.6.3 Retrieving the Alternate URL Collections

The retrieved **Alternate URL Collection Configuration Object Ids** are then passed to **proc_getObject** to retrieve the full contents of the Alternate URL Collection Configuration Objects.

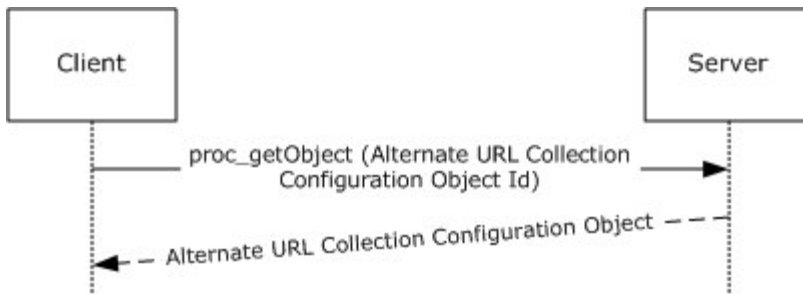

Figure 9: Retrieving the Alternate URL Collections

4.6.4 Alternate URL Matching

At this point, the client can execute the XPath query against the properties of each of the Alternate URL Collections (section 4.6.3) returned to extract all of the alternate URLs. Each of these URLs is then compared against the portion of the incoming URL beginning with the scheme component and ending with the authority component (for example, "http://example.com:80"). If a match is found the configuration object ID of the Alternate URL Collection containing the matching URL is stored for later use as the request Alternate URL Collections. Otherwise, the site collection lookup operation terminates.

4.6.5 Retrieving the Web Service Ids

Next, the **Farm Configuration Object Id** returned and the specified **Web Service Class Id** are passed to **proc_getObjectsByBaseClass**.

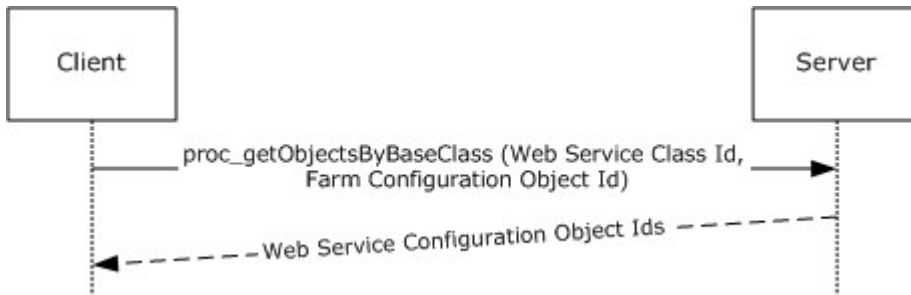

Figure 10: Web Service Lookup Operations

Because the implementation defined the Farm Configuration Object to be the Parent of all Web Services, this call returns the **Configuration Object Ids** of all Web Services stored in the Configuration Database.

4.6.6 Retrieving the Web Application Ids

In this step, the specified Web application **Class Id** is passed to **proc_getObjectsByBaseClass** with each of the retrieved **Web Service Configuration Object Ids**. This returns the Configuration Object Ids of all Web applications (1) in the Configuration Database.

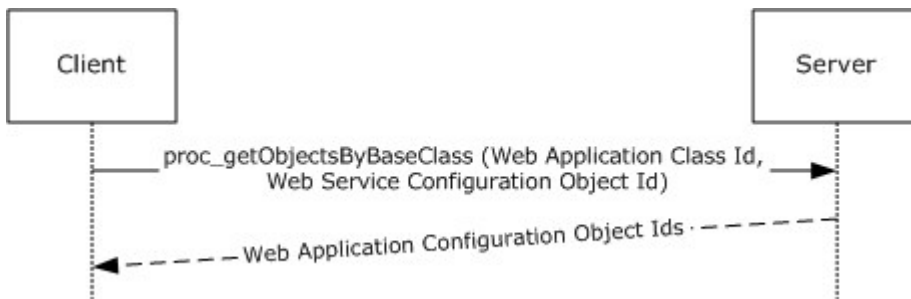

Figure 11: Retrieving the Web Application Ids

4.6.7 Retrieving the Web Applications

The retrieved **Web Application Configuration Object Ids** are then passed to **proc_getObject** to retrieve the full contents of the Web Application Configuration Objects.

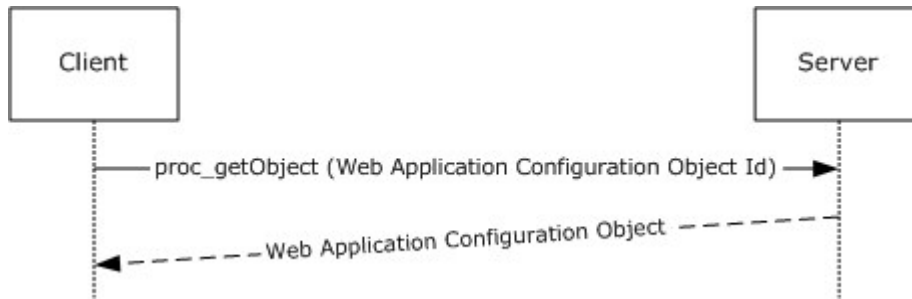

Figure 12: Retrieving the Web Applications

4.6.8 Web Application Lookup

At this point, the client can execute the Web Application Alternate URL Collection XPath Query to extract the **Alternate URL Collection IDs** (section [2.2.5.1.7.1](#)) associated with each retrieved Web application (1). These **Alternate URL Collection IDs** are compared against the **Request Alternate URL Collection ID**. If a match is found, the associated Web application (1) is used as the Request Web application (1) for the remainder of site collection lookup. Otherwise, site collection lookup terminates.

4.6.9 Prefix Matching

Web applications (1) contains a set of site collection Prefixes which contain a name and a type. site collection lookup extracts these values from the Request Web Application Properties using XPath Queries.

The Prefix names are URL Path Components used to determine which portion of the incoming URL Path Component is the server-relative URL of the site collection. This is done by matching all of the Prefixes in the Request Web application (1) against the start of the Path Component of the incoming URL. If more than one Prefix matches the beginning of the incoming URL Path Component, the longest matching Prefix is used.

There are two types of Prefix: wildcard and explicit. A Web application (1) can contain any combination of both types.

4.6.9.1 Explicit Prefixes

An explicit prefix indicates that the portion of the Path Component up to and including the Prefix are included in the site collection server-relative URL. For example, if a user requests `http://example.com/sitename/web/list/document.htm` and if the Web application (1) corresponding to `http://example.com` contains an explicit prefix named "sitename", then `"/sitename"` is the server-relative URL of the site collection.

| Incoming URL | Web Application Explicit Prefixes | Resulting Site Collection Server-Relative URL |
|---|-----------------------------------|---|
| <code>http://example.com/a/b/c.htm</code> | "a" | <code>"/a"</code> |

| Incoming URL | Web Application Explicit Prefixes | Resulting Site Collection Server-Relative URL |
|------------------------------|-----------------------------------|---|
| http://example.com/a/b/c.htm | "a", "a/b" | "/a/b" |
| http://example.com/a/b.htm | "a", "a/b" | "/a" |
| http://example.com/a/b.htm | "c" | <No Match> |
| http://example.com/a/b.htm | "" | "/" |

4.6.9.2 Wildcard Prefixes

A wildcard prefix indicates that the portion of the Path Component up to and including the first Path Component segment following the Prefix are included in the site collection name. For example, if a user makes a request for http://example.com/sites/sitename/web/list/document.htm, and if the Web application (1) corresponding to http://example.com contains a Wildcard Prefix named "sites", then "/sites/sitename" is the server-relative URL of the site collection.

| Incoming URL | Web Application Wildcard Prefixes | Resulting Site Collection Server-Relative URL |
|--------------------------------|-----------------------------------|---|
| http://example.com/a/b/c/d.htm | "a", "a/b" | "/a/b/c" |
| http://example.com/a/b.htm | "a", "a/b" | <No Match> |
| http://example.com/a/b.htm | "" | "/a" |

4.6.10 Site Collection Id Lookup

Once the site collection URL is determined, it is passed to **proc_getSiteMap** (section [3.1.5.38](#)), along with the **Request Web Application ID**.

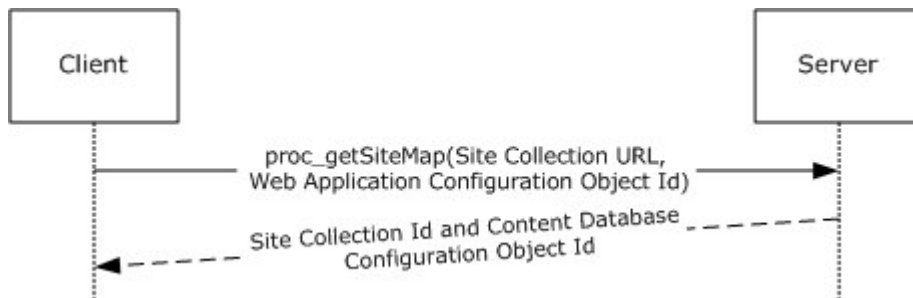

Figure 13: Site Collection Id Lookup

A site collection ID is returned along with the configuration object ID of the content database in which the site collection content is stored. If the specified combination site collection URL and Web application ID cannot be found in the configuration database, the site collection does not exist and site collection lookup terminates.

4.6.11 Building Content Database Connection String

At this point, the only step that remains is to establish a connection to the content database. This requires a content database connection string, which is built by combining the following components.

4.6.11.1 Name

Once the content database ID is known, it is passed to **proc_GetObject**, which returns the content database configuration object (section [2.2.5.1](#)).

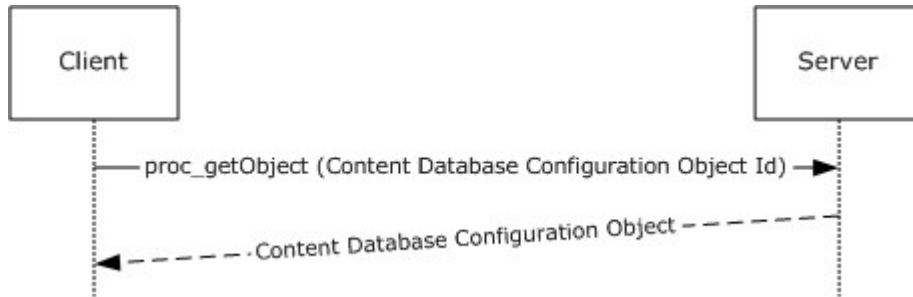

Figure 14: Name

The name field of the content database configuration object is used in the connection string as the content database name.

Credentials

The optional Username and Password are extracted from the Properties of the Content Database configuration object using XPath queries.

Instance

The ParentId of the content database configuration object is passed in another call to **proc_GetObject**, which returns the database service instance configuration object, the name field of which is used as the Database Server Instance.



Figure 15: Database Server Instance

Server Address

The **ParentId** of the Database Service Instance Configuration Object is then passed to the one final call to **proc_getObject**, which returns a server configuration object. The name field of the server configuration object is used as the Server Address component of the connection string.

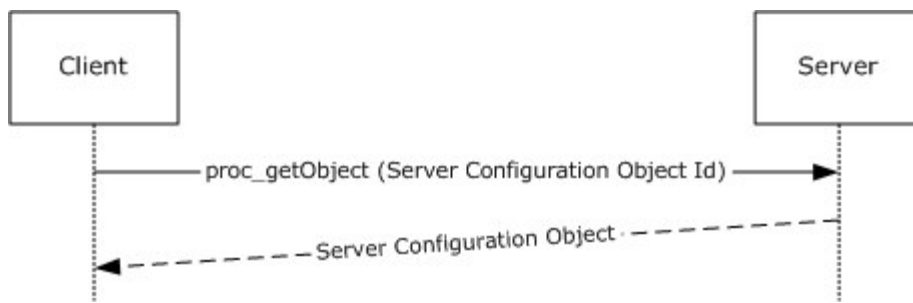

Figure 16: Server Address

At the end of this step, the incoming URL has been successfully translated into a site collection URL, a site collection Id, and a Content Database Connection String. These components are then ready to be used to call other stored procedures in this and other protocols.

4.7 User Update User Properties OM

This example describes the interactions made when site member (1) properties are updated for a particular user.

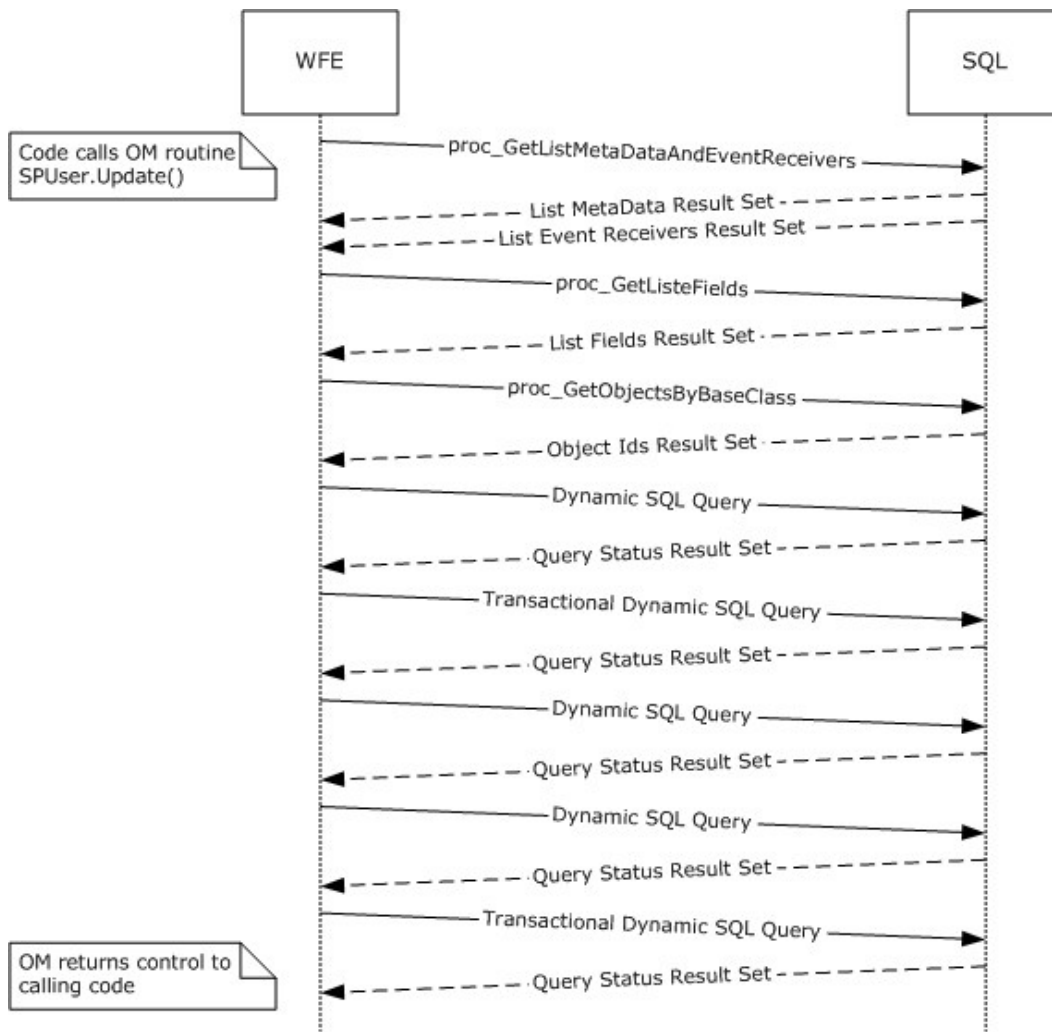

Figure 17: User Update User Properties OM

This scenario is initiated by a call to the object model command **SPUser.Update()**. For simplicity's sake, this example assumes that:

- The code has already instantiated the site collection (**SPSite**) and Web (**SPWeb**) Objects for this session, and
- The user to be updated is in the site collection and a member of the site.

The following actions happen:

1. The WFE fetches the properties for the target site collection's user information list, a SharePoint list containing information about users and groups (2) registered in a site collection. It does this by calling the stored procedure **proc_GetListMetaDataAndEventReceivers** (section [3.1.5.33](#)) using TDS.
2. The BEDS returns two result sets, which include the list metadata (section [2.2.4.14](#)) and event receivers for the specified user information list.

3. If the WFE determines that the user information list has not been populated in the current **SPSite** object, it requests the list field information for the site collection's user information list by calling the stored procedure **proc_GetListFields** using TDS.
4. The BEDS returns a single fields information result set, which includes the field information for the specified user information list.
5. If the WFE determines that it needs to populate the list of **SPFeatures**, the list of child objects that inherit from the base class **SPFeatureDefinition** is populated by calling the configuration database stored procedure **proc_getObjectsByBaseClass** using TDS.
6. The BEDS returns a single Object ID result set, which includes a list of child object identifiers for the specified base class and parent object.
7. The WFE builds a dynamic SQL query to select existing information for the user using TDS.
8. The BEDS returns a single result set, which includes existing data for the user.
9. The WFE builds a transactional dynamic SQL query to update the user information in the site. This query is sent to the SQL server using TDS. On the SQL server the following actions occur:
 - The query begins a new SQL transaction.
 - The query attempts to update the user information using the stored procedure **proc_SecUpdateUser** (section [3.1.5.121](#)).
 - The query attempts to update the user's properties in the site's user information list using the stored procedure **proc_UpdateListItem** (section [3.1.5.127](#)).
 - The query rolls back the SQL transaction if the previous procedures were not successful, or it commits the transaction if they were successful.
10. The BEDS returns a single result set, which indicates the return code status of the actions within the query.
11. The WFE builds a dynamic SQL query to select updated information for the user using TDS.
12. The BEDS returns a single result set, which includes the data for the user.
13. The WFE builds a transactional dynamic SQL query to update the user information in the site. This query is sent to the SQL server using TDS. On the SQL server the following actions occur:
 - The query begins a new SQL transaction.
 - The query attempts to update the site collection's user list data using the stored procedure **proc_UpdateListItem**.
 - Then the query attempts to update the user's properties in the site collection's user information table using the stored procedure **proc_UpdateUserInfoInTableFromRowUpdater** (section [3.1.5.129](#)).
 - The query rolls back the SQL transaction if the previous procedures were not successful, or it commits the transaction if they were successful.
14. The BEDS returns a successful return code status.

4.8 Version Negotiation

The following scenario is an example of the protocol version negotiation sequence between a WFE and a content database where the content database version does not match that expected by the WFE.

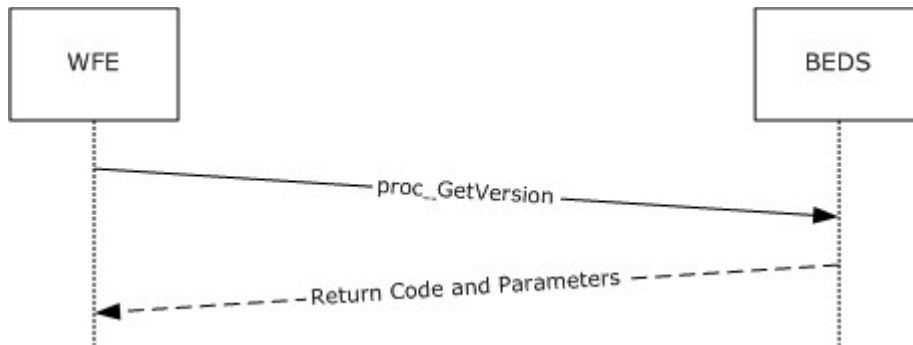

Figure 18: Version Negotiation

1. The WFE calls the **proc_GetVersion** (section [3.1.5.42](#)) stored procedure in the content database on the BEDS, with the `@VersionId` parameter set to '6333368D-85F0-4EF5-8241-5252B12B2E50'.
2. The **proc_GetVersion** stored procedure returns the output parameter `@Version` with a value of '3.0.149.0'. The application has a pre-defined version of '0', which reflects the current state of the software. Any new database created by this application will have this version. The application determines that the version from the database is smaller (meaning it is older) than the version the WFE expects, and does not perform any further operations against the database.

4.9 Folder: Move Folder OM

This example describes the requests and responses made when a folder is moved within a list using an object model call.

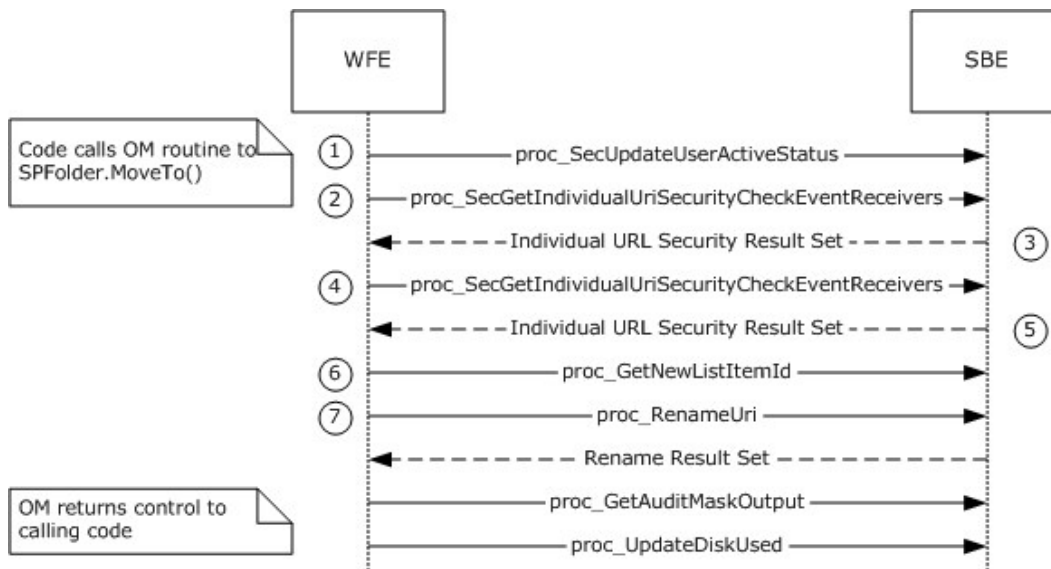

Figure 19: Folder: Move Folder OM

This scenario is initiated by a call to the **SPFolder.MoveTo()** object model command. This example assumes that:

- The code has already instantiated the site collection (**SPSite**), site (**SPWeb**), list (**SPList**), and list folder (**SPFolder**) objects.
- The folder destination location is valid
- The current user has permissions to view the folder

The following actions happen:

1. The front-end Web server builds a dynamic query that invokes the **proc_SecUpdateUserActiveStatus** stored procedure.
2. The front-end Web server builds a dynamic query that invokes the **proc_SecGetIndividualUrlSecurityCheckEventReceivers** stored procedure against the source folder.
3. The back-end database server returns a return code of 0, and returns the following result sets:
 - **Individual URL Security Result Set.** This returns security information about the specific source folder.
4. The front-end Web server builds a dynamic query that invokes the **proc_SecGetIndividualUrlSecurityCheckEventReceivers** stored procedure against the destination folder.
5. The back-end database server returns a return code of 0, and returns the following result sets:
 - **Individual URL Security Result Set.** This returns security information about the specific destination folder.
7. The front-end Web server builds a dynamic query that invokes the **proc_GetNewListItemId** stored procedure.
8. The front-end Web server builds a transactional dynamic SQL query to move the folder.
 - The query begins a new SQL transaction.
 - The query attempts to rename the URL for the folder using the **proc_RenameUrl** stored procedure. The back-end database server returns a return code of 0, and returns the **Rename Result Set**, which gives basic information about the old and new URLs for the renamed folder.
 - The query attempts to get **Audit Flags** information about the new folder using the **proc_GetAuditMaskOutput** stored procedure.
 - The query rolls back the SQL transaction if any of the previous procedures were not successful.
 - Assuming the previous procedures were successful, the query updates the disk spaced used for the site by calling the **proc_UpdateDiskUsed** stored procedure, and commits the transaction

5 Security

5.1 Security Considerations for Implementers

Security for this protocol is controlled by the access rights to the databases on the back-end database server, which is negotiated as part of the Tabular Data Stream [MS-TDS] protocol.

In a trusted subsystem model, the process running on the web front end server uses its own security principal identity to access the content database on the back-end database server on behalf of the user, rather than using the account of the user accessing the web front end as a database access account to access the content database. The database access account used by the web front end server needs to have access to the content database on the back-end database server. If the account does not have the correct access rights, access will be denied when attempting to set up the [MS-TDS] connection to the content database, or when calling the stored procedures.

5.2 Index of Security Parameters

| Security Parameter | Section |
|---|--------------------------|
| proc_SecAddPrincipalToRole | 3.1.5.49 |
| proc_SecAddRoleDef | 3.1.5.50 |
| proc_SecAddUser | 3.1.5.51 |
| proc_SecAddUserToSiteGroup | 3.1.5.52 |
| proc_SecAddWebMembership | 3.1.5.53 |
| proc_SecChangeToInheritedList | 3.1.5.54 |
| proc_SecChangeToInheritedWeb | 3.1.5.55 |
| proc_SecChangeToUniqueScope | 3.1.5.56 |
| proc_SecCheckDeletedAccounts | 3.1.5.57 |
| proc_SecCloneRoleDefinitions | 3.1.5.58 |
| proc_SecCreateSiteGroup | 3.1.5.59 |
| proc_SecDecCurrentUsersCount | 3.1.5.60 |
| proc_SecGetAccountStatus | 3.1.5.61 |
| proc_SecGetAclFromScope | 3.1.5.62 |
| proc_SecGetAllAclsForSite | 3.1.5.63 |
| proc_SecGetAllGroupsAndMembershipInfo | 3.1.5.64 |
| Proc_SecGetApplicationPrincipalAndUserToken | 3.1.5.65 |
| proc_SecGetCompleteWebRoleMemberList | 3.1.5.66 |
| proc_SecGetCurrentUsersCount | 3.1.5.67 |
| proc_SecGetDomainGroupMapData | 3.1.5.68 |

| Security Parameter | Section |
|---|--------------------------|
| proc_SecGetGroupById | 3.1.5.69 |
| proc_SecGetGroupOwner | 3.1.5.70 |
| proc_SecGetGroupSecurityScopes | 3.1.5.71 |
| proc_SecGetIndividualUrlSecurityCheckEventReceivers | 3.1.5.72 |
| Proc_SecGetItemsWithUniquePermissions | 3.1.5.73 |
| proc_SecGetPrincipalByEmail | 3.1.5.74 |
| proc_SecGetPrincipalById | 3.1.5.75 |
| Proc_SecGetPrincipalByIdEx | 3.1.5.76 |
| proc_SecGetPrincipalByLogin | 3.1.5.77 |
| proc_SecGetPrincipalByLogin20 | 3.1.5.78 |
| proc_SecGetPrincipalDisplayInformation20 | 3.1.5.79 |
| proc_SecGetRoleAssignments | 3.1.5.80 |
| proc_SecGetRoleBindingsForAllPrincipals | 3.1.5.81 |
| proc_SecGetRoleDefs | 3.1.5.82 |
| proc_SecGetSecurityInfo | 3.1.5.83 |
| proc_SecGetSiteAdmins | 3.1.5.84 |
| proc_SecGetSiteGroupById | 3.1.5.85 |
| proc_SecGetSiteGroupByTitle | 3.1.5.86 |
| proc_SecGetSiteGroupByTitle20 | 3.1.5.87 |
| proc_SecGetUserAccountDirectoryPath | 3.1.5.88 |
| proc_SecGetUserPermissionOnGroup | 3.1.5.89 |
| Proc_SecGetWebsAndListsWithUniquePermissions | 3.1.5.90 |
| proc_SecListAllSiteMembers | 3.1.5.91 |
| proc_SecListAllWebMembers | 3.1.5.92 |
| proc_SecListGroupsWithRole | 3.1.5.93 |
| proc_SecListScopeGroups | 3.1.5.94 |
| proc_SecListScopeUsers | 3.1.5.95 |
| proc_SecListSiteGroupMembership | 3.1.5.96 |
| proc_SecListSiteGroups | 3.1.5.97 |
| proc_SecListSiteGroupsContainingUser | 3.1.5.98 |

| Security Parameter | Section |
|---|---------------------------|
| proc_SecListSiteGroupsWhichUserOwns | 3.1.5.99 |
| proc_SecListUsersInRole | 3.1.5.100 |
| proc_SecMigrateUser | 3.1.5.101 |
| proc_SecReCalculateWebFGP | 3.1.5.102 |
| proc_SecRefreshToken | 3.1.5.103 |
| proc_SecRemoveGroup | 3.1.5.104 |
| proc_SecRemovePrincipalFromScope | 3.1.5.106 |
| proc_SecRemoveRoleDef | 3.1.5.107 |
| proc_SecRemoveUserFromScopeByLogin | 3.1.5.108 |
| proc_SecRemoveUserFromSite | 3.1.5.109 |
| proc_SecRemoveUserFromSiteGroup | 3.1.5.110 |
| proc_SecRemoveUserFromSiteGroupByLogin | 3.1.5.111 |
| proc_SecResetItemPerm | 3.1.5.112 |
| proc_SecResetWebToDefaultRoleDefinition | 3.1.5.113 |
| proc_SecResolvePrincipal | 3.1.5.114 |
| proc_SecSetSiteGroupProperties | 3.1.5.115 |
| proc_SecSetUserAccountDirectoryPath | 3.1.5.116 |
| proc_SecSetWebRequestAccess | 3.1.5.117 |
| proc_SecUpdateAnonymousPermMask | 3.1.5.118 |
| proc_SecUpdateDomainGroupMapData | 3.1.5.119 |
| proc_SecUpdateRoleDef | 3.1.5.120 |
| proc_SecUpdateUser | 3.1.5.121 |
| proc_SecUpdateUserActiveStatus | 3.1.5.122 |

6 Appendix A: Product Behavior

The information in this specification is applicable to the following Microsoft products or supplemental software. References to product versions include released service packs:

- Microsoft SharePoint Foundation 2013

Exceptions, if any, are noted below. If a service pack or Quick Fix Engineering (QFE) number appears with the product version, behavior changed in that service pack or QFE. The new behavior also applies to subsequent service packs of the product unless otherwise specified. If a product edition appears with the product version, behavior is different in that product edition.

Unless otherwise specified, any statement of optional behavior in this specification that is prescribed using the terms SHOULD or SHOULD NOT implies product behavior in accordance with the SHOULD or SHOULD NOT prescription. Unless otherwise specified, the term MAY implies that the product does not follow the prescription.

[<1> Section 2.2.1.1.10:](#) For example, by default, SharePoint Foundation 2013 creates three implementation-specific site groups with default site group identifiers for use in role assignments when provisioning a new site collection: "Site Owners" (3), "Site Visitors" (4), and "Site Members" (5).

[<2> Section 2.2.2.8:](#) This flag is not used in SharePoint Foundation 2013.

[<3> Section 2.2.6.1:](#) SharePoint Foundation 2013 only uses value 0 and 1.

[<4> Section 2.2.7.3.3.2:](#) SharePoint Foundation 2013 allows a filtering user interface for fields with the aggregation attribute set to merge, but only in list views where Filter=1 occurs in the view's query parameter.

[<5> Section 2.2.7.3.3.2:](#) SharePoint Foundation 2013 does include this attribute with a value of 0.

[<6> Section 2.2.7.3.3.2:](#) SharePoint Foundation 2013 sets the value MinusSign for this field.

[<7> Section 2.2.7.3.3.3:](#) SharePoint Foundation 2010 omits this data if present in the underlying template definition, even if the field type is not of the specified type.

[<8> Section 2.2.7.3.3.3:](#) SharePoint Foundation 2010 omits this data if present in the underlying template definition, even if the field type is not of the specified type.

[<9> Section 2.2.7.3.3.3:](#) SharePoint Foundation 2010 omits this data if present in the underlying template definition, even if the field type is not of the specified type.

[<10> Section 2.2.7.3.3.3:](#) SharePoint Foundation 2010 omits this data if present in the underlying template definition, even if the field type is not of the specified type.

[<11> Section 2.2.7.3.3.3:](#) SharePoint Foundation 2010 omits this data if present in the underlying template definition, even if the field type is not of the specified type.

[<12> Section 3.1.5.42:](#) SharePoint products use text-based SQL queries to get the version number which are equivalent in functionality to **proc_GetVersion**.

7 Change Tracking

This section identifies changes that were made to the [MS-WSSFO3] protocol document between the April 2014 and July 2014 releases. Changes are classified as New, Major, Minor, Editorial, or No change.

The revision class **New** means that a new document is being released.

The revision class **Major** means that the technical content in the document was significantly revised. Major changes affect protocol interoperability or implementation. Examples of major changes are:

- A document revision that incorporates changes to interoperability requirements or functionality.
- The removal of a document from the documentation set.

The revision class **Minor** means that the meaning of the technical content was clarified. Minor changes do not affect protocol interoperability or implementation. Examples of minor changes are updates to clarify ambiguity at the sentence, paragraph, or table level.

The revision class **Editorial** means that the formatting in the technical content was changed. Editorial changes apply to grammatical, formatting, and style issues.

The revision class **No change** means that no new technical changes were introduced. Minor editorial and formatting changes may have been made, but the technical content of the document is identical to the last released version.

Major and minor changes can be described further using the following change types:

- New content added.
- Content updated.
- Content removed.
- New product behavior note added.
- Product behavior note updated.
- Product behavior note removed.
- New protocol syntax added.
- Protocol syntax updated.
- Protocol syntax removed.
- New content added due to protocol revision.
- Content updated due to protocol revision.
- Content removed due to protocol revision.
- New protocol syntax added due to protocol revision.
- Protocol syntax updated due to protocol revision.
- Protocol syntax removed due to protocol revision.

- Obsolete document removed.

Editorial changes are always classified with the change type **Editorially updated**.

Some important terms used in the change type descriptions are defined as follows:

- **Protocol syntax** refers to data elements (such as packets, structures, enumerations, and methods) as well as interfaces.
- **Protocol revision** refers to changes made to a protocol that affect the bits that are sent over the wire.

The changes made to this document are listed in the following table. For more information, please contact dochelp@microsoft.com.

| Section | Tracking number (if applicable) and description | Major change (Y or N) | Change type |
|--|---|-----------------------|----------------------------------|
| 2.2.3.8 WSS Compressed Structures | Updated "WSS v4" to "Microsoft SharePoint Foundation 2013". | N | Content updated. |
| 2.2.4.6 Document Content Metadata Result Set | Added SetupPathVersion for SharePoint Foundation 2013. | N | New content added. |
| 2.2.4.8 Document Metadata Result Set | Added SetupPathVersion for SharePoint Foundation 2013. | N | New content added. |
| 2.2.4.9 Document Version Metadata Result Set | Added SetupPathVersion for SharePoint Foundation 2013. | N | New content added. |
| 2.2.4.12 Individual URL Security Result Set | Added description for the "bNeedNoThrottle". | N | Content updated. |
| 2.2.6.1 AllDocs Table | Added SetupPathVersion for SharePoint Foundation 2013. | N | New content added. |
| 2.2.6.1 AllDocs Table | Updated description for the SortBehavior value. | N | Content updated. |
| 2.2.6.1 AllDocs Table | Added note to specify SharePoint Foundation 2013's behavior for SortBehavior value. | N | New product behavior note added. |
| 2.2.7.2.6 IMEMode | Deleted the table of explanation for the numbering below IMEMODE schema. | N | Content updated. |
| 2.2.7.3.3.2 Attributes | Updated the description for the CountRelated attribute. | N | Content updated. |
| 2.2.7.3.9.1 Schema | Added "Format" attribute into schema definition. | N | Content updated. |
| 2.2.7.3.9.2 Attributes | Added description for the added "Format" attribute. | N | Content updated. |

| Section | Tracking number (if applicable) and description | Major change (Y or N) | Change type |
|---|--|------------------------------|--------------------|
| 3.1.4 Higher-Layer Triggered Events | Added content. | N | Content updated. |
| 3.1.5.15 proc_DirtyDependents | Updated the description of value 3 and value 4 for @DepType. | N | Content updated. |
| 3.1.5.19.13 Document Build Dependency Metadata Result Set | Added SetupPathVersion for SharePoint Foundation 2013. | N | New content added. |
| 3.1.5.29.6 Multiple Document Metadata Result Set | Added SetupPathVersion for SharePoint Foundation 2013. | N | New content added. |
| 3.1.5.47.5 Document Metadata Result Set | Added SetupPathVersion for SharePoint Foundation 2013. | N | New content added. |
| 3.1.5.47.7 Contained Document Metadata Result Set | Added SetupPathVersion for SharePoint Foundation 2013. | N | New content added. |
| 3.1.5.51 proc_SecAddUser | Added description for parameter @AccountType. | N | New content added. |
| | Added a definition number for the term "form" where it appears throughout the document. | N | Content updated. |
| | Added a definition number for the term "member" where it appears throughout the document. | N | Content updated. |
| | Added a definition number for the term "group" where it appears throughout the document. | N | Content updated. |
| | Added a definition number for the term "field" where it appears throughout the document. | N | Content updated. |
| | Added a definition number for the term "stream" where it appears throughout the document. | N | Content updated. |
| | Added a definition number for the term "event" where it appears throughout the document. | N | Content updated. |
| | Added a definition number for the term "Web application" where it appears throughout the document. | N | Content updated. |
| | Removed section 4.9 File: Add File OM. | N | Content removed. |

| Section | Tracking number (if applicable) and description | Major change (Y or N) | Change type |
|----------------|---|------------------------------|--------------------|
| | Removed section 2.2.8.1 tvpArrayOfGuids because the table type it described is not used in this protocol. | N | Content removed. |

8 Index

A

Abstract data model
 [client](#) 475
 [server](#) 219
[ACL and Permission result set](#) 60
[App Principal Information result set](#) 95
[App Principal Permissions result set](#) 95
[Applicability](#) 23
[Attribute groups - overview](#) 216
[Attributes - overview](#) 216

B

Binary structures
 [Calendar View Options Type](#) 53
 [External Group Token](#) 54
 [Token Group Offset and Attributes](#) 55
 [Token Groups](#) 56
 [WSS ACE](#) 56
 [WSS ACL Format](#) 57
 [WSS Compressed Structures](#) 58
 [WSS External Group Map Cache Format](#) 57
 [WSS External Group Record](#) 59
 [WSS User Token](#) 59

C

[Calendar View Options Type binary structure](#) 53
[Capability negotiation](#) 23
[Change tracking](#) 501
[CHOICEDEFINITION - complex type](#) 196
[CHOICEDEFINITIONS - complex type](#) 197
Client
 [abstract data model](#) 475
 [higher-layer triggered events](#) 476
 [initialization](#) 476
 [local events](#) 476
 [message processing](#) 476
 [sequencing rules](#) 476
 [timer events](#) 476
 [timers](#) 476
Common data types
 [overview](#) 24
Complex types
 [CHOICEDEFINITION](#) 196
 [CHOICEDEFINITIONS](#) 197
 [FieldDefinition](#) 197
 [FieldDefinitionDatabase](#) 211
 [FieldDefinitionDatabaseWithVersion](#) 211
 [FieldDefinitionTP](#) 212
 [FieldParserRef](#) 212
 [FieldParserRefs](#) 213
 [FieldRefDefinitionField](#) 213
 [FieldRefDefinitionIndex](#) 214
 [FieldRefDefinitionTP](#) 214
 [IndexDefinitionTP](#) 215
 [MAPPINGDEFINITION](#) 215

[MAPPINGDEFINITIONS](#) 216
[Custom Actions From Scope result set](#) 60

D

Data model - abstract
 [client](#) 475
 [server](#) 219
Data types
 [common](#) 24
[Document Content Metadata result set](#) 62
[Document Content Stream result set](#) 64
[Document Metadata result set](#) 64
[Document Version Metadata result set](#) 68
[Domain Group Cache BEDS Update result set](#) 61
[Domain Group Cache Versions result set](#) 61
[Domain Group Cache WFE Update result set](#) 62

E

[Elements - overview](#) 216
[Empty result set](#) 73
[Event Receivers result set](#) 73
Events
 [local - client](#) 476
 [local - server](#) 475
 [timer - client](#) 476
 [timer - server](#) 475
Examples
 [File - determine a user's permission level to a document](#) 478
 [File - open file OM](#) 477
 [Folder - move folder OM](#) 495
 [Group add user to site group OM](#) 479
 [Group update site group properties OM](#) 481
 [overview](#) 477
 [Security - add user to document library via object model](#) 483
 [Security - break web inheritance OM](#) 485
 [Site collection lookup](#) 486
 [Site collection lookup - alternate URL matching](#) 488
 [Site collection lookup - building content database connection string](#) 491
 [Site collection lookup - prefix matching](#) 489
 [Site collection lookup - retrieving the alternate URL collection identifiers](#) 487
 [Site collection lookup - retrieving the alternate URL collections](#) 487
 [Site collection lookup - retrieving the farm identifier](#) 486
 [Site collection lookup - retrieving the web application identifiers](#) 488
 [Site collection lookup - retrieving the web applications](#) 489
 [Site collection lookup - retrieving the web service identifiers](#) 488

[Site collection lookup – site collection identifier lookup](#) 490
[Site collection lookup – web application lookup](#) 489
[User update user properties OM](#) 492
[Version negotiation](#) 495
[External Group Token binary structure](#) 54

F

[FALSE Case Insensitive Else Anything - simple type](#) 190
[FieldAggregationAttribute - simple type](#) 192
[FieldDefinition - complex type](#) 197
[FieldDefinitionDatabase - complex type](#) 211
[FieldDefinitionDatabaseWithVersion - complex type](#) 211
[FieldDefinitionTP - complex type](#) 212
[FieldInternalType - simple type](#) 190
[FieldParserRef - complex type](#) 212
[FieldParserRefs - complex type](#) 213
[FieldRefDefinitionField - complex type](#) 213
[FieldRefDefinitionIndex - complex type](#) 214
[FieldRefDefinitionTP - complex type](#) 214
[FieldRefType - simple type](#) 193
[FieldRichTextMode - simple type](#) 193
[Fields - vendor-extensible](#) 23
[File – determine a user’s permission level to a document example](#) 478
[File – open file OM example](#) 477
[fn_GetFullUrl method](#) 229
[Folder – move folder OM example](#) 495

G

[Glossary](#) 16
[Group add user to site group OM example](#) 479
[Group update site group properties OM example](#) 481
[Groups - overview](#) 216

H

Higher-layer triggered events
[client](#) 476
[server](#) 220

I

[IMEMode - simple type](#) 194
[Implementer - security considerations](#) 497
[Index of security parameters](#) 497
[IndexDefinitionTP - complex type](#) 215
[Individual URL Security result set](#) 75
[Informative references](#) 21
Initialization
[client](#) 476
[server](#) 220
[IntPositive - simple type](#) 194
[Introduction](#) 16

J

[JoinType - simple type](#) 194

L

[Link Information result set](#) 77
[List Metadata result set](#) 78
[List Related Fields result set](#) 94
[List Web Parts result set](#) 82
Local events
[client](#) 476
[server](#) 475

M

[MAPPINGDEFINITION - complex type](#) 215
[MAPPINGDEFINITIONS - complex type](#) 216
Message processing
[client](#) 476
[server](#) 220
Messages
[ACL and Permission result set](#) 60
[App Principal Information result set](#) 95
[App Principal Permissions result set](#) 95
[attribute groups](#) 216
[attributes](#) 216
[Calendar View Options Type binary structure](#) 53
[CHOICEDEFINITIONcomplex type](#) 196
[CHOICEDEFINITIONScomplex type](#) 197
[common data types](#) 24
[Custom Actions From Scope result set](#) 60
[Document Content Metadata result set](#) 62
[Document Content Stream result set](#) 64
[Document Metadata result set](#) 64
[Document Version Metadata result set](#) 68
[Domain Group Cache BEDS Update result set](#) 61
[Domain Group Cache Versions result set](#) 61
[Domain Group Cache WFE Update result set](#) 62
[elements](#) 216
[Empty result set](#) 73
[Event Receivers result set](#) 73
[External Group Token binary structure](#) 54
[FALSE Case Insensitive Else Anythingsimple type](#) 190
[FieldAggregationAttributesimple type](#) 192
[FieldDefinitioncomplex type](#) 197
[FieldDefinitionDatabasecomplex type](#) 211
[FieldDefinitionDatabaseWithVersioncomplex type](#) 211
[FieldDefinitionTPcomplex type](#) 212
[FieldInternalTypesimple type](#) 190
[FieldParserRefcomplex type](#) 212
[FieldParserRefscomplex type](#) 213
[FieldRefDefinitionFieldcomplex type](#) 213
[FieldRefDefinitionIndexcomplex type](#) 214
[FieldRefDefinitionTPcomplex type](#) 214
[FieldRefTypesimple type](#) 193
[FieldRichTextModesimple type](#) 193
[groups](#) 216
[IMEModesimple type](#) 194
[IndexDefinitionTPcomplex type](#) 215
[Individual URL Security result set](#) 75
[IntPositivesimple type](#) 194

[JoinTypesimple type](#) 194
[Link Information result set](#) 77
[List Metadata result set](#) 78
[List Related Fields result set](#) 94
[List Web Parts result set](#) 82
[MAPPINGDEFINITIONcomplex type](#) 215
[MAPPINGDEFINITIONScomplex type](#) 216
[namespaces](#) 190
[NULL Individual URL Security result set](#) 83
[NULL Unique Permissions result set](#) 84
[Object ID result set](#) 85
[Principal User Information result set](#) 85
[RelationshipDeleteBehaviorAttributesimple type](#)
196
[result sets](#) 60
[Server Time result set](#) 85
[Single Doc Link Information result set](#) 86
[Site Audit Mask result set](#) 87
[Site Feature List result set](#) 87
[Site Metadata result set](#) 87
[Site MetaInfo result set](#) 93
[TextDirectionsimple type](#) 194
[Token Group Offset and Attributes binary
structure](#) 55
[Token Groups binary structure](#) 56
[transport](#) 24
[TRUE Case Sensitive Else Anythingsimple type](#)
195
[TRUE If Presentsimple type](#) 195
[TRUEFALSEsimple type](#) 195
[Unique Permissions result set](#) 94
[UniqueIdentifierWithBracesUppercasesimple type](#)
195
[UniqueIdentifierWithOrWithoutBracessimple type](#)
196
[URL result set](#) 94
[WSS ACE binary structure](#) 56
[WSS ACL Format binary structure](#) 57
[WSS Compressed Structures binary structure](#) 58
[WSS External Group Map Cache Format binary
structure](#) 57
[WSS External Group Record binary structure](#) 59
[WSS User Token binary structure](#) 59
[XML structures](#) 190
Methods
[fn_GetFullUrl](#) 229
[proc_AddBuildDependency](#) 230
[proc_AddDocument](#) 230
[proc_AddListItem](#) 235
[proc_ChangeLevelForDoc](#) 241
[proc_CheckoutDocument](#) 243
[proc_CheckRbsInstalled](#) 242
[proc_ClearLinks](#) 246
[proc_CreateDir](#) 247
[proc_DeleteAllDocumentVersions](#) 249
[proc_DeleteDocBuildDependencySet](#) 251
[proc_DeleteDocumentVersion](#) 251
[proc_DeleteUrl](#) 252
[proc_DirtyDependents](#) 256
[proc_DisableRbs](#) 256
[proc_EnableRbs](#) 257
[proc_EnumLists](#) 258
[proc_FetchDocForHttpGet](#) 264
[proc_FetchDocForRead](#) 285
[proc_FetchDocForUpdate](#) 291
[proc_FetchWelcomeNames](#) 298
[proc_GenerateNextId](#) 298
[proc_GetAllRolesForUser](#) 299
[proc_GetAuditMask](#) 300
[proc_GetAuditMaskOutput](#) 300
[proc_GetContainingList](#) 301
[proc_GetContainingListCore](#) 302
[proc_GetDocsMetaInfo](#) 304
[proc_GetLinkInfoSingleDoc](#) 312
[proc_GetListCheckedOutFiles](#) 312
[proc_GetListFields](#) 313
[proc_GetListMetaDataAndEventReceivers](#) 314
[proc_GetNewListItemId](#) 474
[proc_getObject](#) 316
[proc_getObjectsByBaseClass](#) 317
[proc_getObjectsByClass](#) 318
[proc_GetSiteDenyPermMask](#) 473
[proc_GetSiteFlags](#) 319
[proc_getSiteMap](#) 319
[proc_getSiteMapById](#) 320
[proc_GetTpWebMetaDataAndListMetaData](#) 322
[proc_GetUniqueScopesInList](#) 334
[proc_GetVersion](#) 335
[proc_GetWebMetaInfo](#) 336
[proc_GetWebMetaInfoByUrl](#) 338
[proc_HasCurrentPublishVersion](#) 473
[proc_ListDocumentVersions](#) 341
[proc_ListRbsStores](#) 343
[proc_ListUrls](#) 343
[proc_ReadStream](#) 263
[proc_RenameUrl](#) 354
[proc_SecAddPrincipalToRole](#) 358
[proc_SecAddRoleDef](#) 359
[proc_SecAddUser](#) 360
[proc_SecAddUserToSiteGroup](#) 363
[proc_SecAddWebMembership](#) 364
[proc_SecChangeToInheritedList](#) 365
[proc_SecChangeToInheritedWeb](#) 365
[proc_SecChangeToUniqueScope](#) 366
[proc_SecCheckDeletedAccounts](#) 368
[proc_SecCloneRoleDefinitions](#) 369
[proc_SecCreateSiteGroup](#) 370
[proc_SecDecCurrentUsersCount](#) 372
[proc_SecGetAccountStatus](#) 372
[proc_SecGetAclFromScope](#) 373
[proc_SecGetAllAclsForSite](#) 374
[proc_SecGetAllGroupsAndMembershipInfo](#) 374
[proc_SecGetApplicationPrincipalAndUserToken](#)
376
[proc_SecGetCompleteWebRoleMemberList](#) 377
[proc_SecGetCurrentUsersCount](#) 378
[proc_SecGetDomainGroupMapData](#) 379
[proc_SecGetGroupById](#) 380
[proc_SecGetGroupOwner](#) 381
[proc_SecGetGroupSecurityScopes](#) 381
[proc_SecGetIndividualUrlSecurityCheckEventRece
ivers](#) 382

[proc_SecGetItemsWithUniquePermissions](#) 384
[proc_SecGetPrincipalByEmail](#) 386
[proc_SecGetPrincipalById](#) 386
[proc_SecGetPrincipalByIdEx](#) 388
[proc_SecGetPrincipalByLogin](#) 390
[proc_SecGetPrincipalByLogin20](#) 391
[proc_SecGetPrincipalDisplayInformation20](#) 392
[proc_SecGetRoleAssignments](#) 395
[proc_SecGetRoleBindingsForAllPrincipals](#) 396
[proc_SecGetRoleDefs](#) 396
[proc_SecGetSecurityInfo](#) 397
[proc_SecGetSiteAdmins](#) 399
[proc_SecGetSiteGroupById](#) 400
[proc_SecGetSiteGroupByTitle](#) 400
[proc_SecGetSiteGroupByTitle20](#) 401
[proc_SecGetUserAccountDirectoryPath](#) 402
[proc_SecGetUserPermissionOnGroup](#) 402
[proc_SecGetWebsAndListWithUniquePermissions](#)
 403
[proc_SecListAllSiteMembers](#) 406
[proc_SecListAllWebMembers](#) 407
[proc_SecListGroupsInRole](#) 408
[proc_SecListScopeGroups](#) 408
[proc_SecListScopeUsers](#) 409
[proc_SecListSiteGroupMembership](#) 410
[proc_SecListSiteGroups](#) 411
[proc_SecListSiteGroupsContainingUser](#) 411
[proc_SecListSiteGroupsWhichUserOwns](#) 412
[proc_SecListUsersInRole](#) 412
[proc_SecMarkGroupForWebDelete](#) 417
[proc_SecMigrateUser](#) 413
[proc_SecReCalculateWebFGP](#) 414
[proc_SecRefreshToken](#) 415
[proc_SecRemoveGroup](#) 416
[proc_SecRemovePrincipalFromScope](#) 418
[proc_SecRemoveRoleDef](#) 420
[proc_SecRemoveUserFromScopeByLogin](#) 420
[proc_SecRemoveUserFromSite](#) 421
[proc_SecRemoveUserFromSiteGroup](#) 422
[proc_SecRemoveUserFromSiteGroupByLogin](#) 423
[proc_SecResetItemPerm](#) 425
[proc_SecResetWebToDefaultRoleDefinition](#) 426
[proc_SecResolvePrincipal](#) 427
[proc_SecSetSiteGroupProperties](#) 429
[proc_SecSetUserAccountDirectoryPath](#) 431
[proc_SecSetWebRequestAccess](#) 432
[proc_SecUpdateAnonymousPermMask](#) 432
[proc_SecUpdateDomainGroupMapData](#) 433
[proc_SecUpdateRoleDef](#) 434
[proc_SecUpdateUser](#) 435
[proc_SecUpdateUserActiveStatus](#) 436
[proc_SetStreamsToDoc](#) 468
[proc_SetStreamsToDocNoTVP](#) 469
[proc_TakeOverCheckOut](#) 436
[proc_UncheckoutDocument](#) 437
[proc_UpdateDiskUsed](#) 474
[proc_UpdateDocBuildDependencySet](#) 439
[proc_UpdateDocument](#) 440
[proc_UpdateListItem](#) 446
[proc_UpdateListSettings](#) 452

[proc_UpdateUserInfoInTableFromRowUpdater](#)
 457
[proc_UrlToWebUrl](#) 458
[proc_WriteChunkToAllDocStreams](#) 459
[proc_WriteStreams](#) 465
[proc_WriteStreamToRBS](#) 464
[proc_WriteStreamToSQL](#) 466
[TVF_Docs_Url_Level](#) 471
[TVF_UserData_ListItemLevelRow](#) 471
[TVF_UserData_Pid_Did_Level_Row](#) 472

N

[Namespaces](#) 190
[Normative references](#) 20
[NULL_Individual_URL_Security_result_set](#) 83
[NULL_Unique_Permissions_result_set](#) 84

O

[Object ID result set](#) 85
[Overview \(synopsis\)](#) 21

P

[Parameters - security index](#) 497
[Preconditions](#) 23
[Prerequisites](#) 23
[Principal User Information result set](#) 85
[proc_AddBuildDependency_method](#) 230
[proc_AddDocument_method](#) 230
[proc_AddListItem_method](#) 235
[proc_ChangeLevelForDoc_method](#) 241
[proc_CheckoutDocument_method](#) 243
[proc_CheckRbsInstalled_method](#) 242
[proc_ClearLinks_method](#) 246
[proc_CreateDir_method](#) 247
[proc_DeleteAllDocumentVersions_method](#) 249
[proc_DeleteDocBuildDependencySet_method](#) 251
[proc_DeleteDocumentVersion_method](#) 251
[proc_DeleteUrl_method](#) 252
[proc_DirtyDependents_method](#) 256
[proc_DisableRbs_method](#) 256
[proc_EnableRbs_method](#) 257
[proc_EnumLists_method](#) 258
[proc_FetchDocForHttpGet_method](#) 264
[proc_FetchDocForRead_method](#) 285
[proc_FetchDocForUpdate_method](#) 291
[proc_FetchWelcomeNames_method](#) 298
[proc_GenerateNextId_method](#) 298
[proc_GetAllRolesForUser_method](#) 299
[proc_GetAuditMask_method](#) 300
[proc_GetAuditMaskOutput_method](#) 300
[proc_GetContainingList_method](#) 301
[proc_GetContainingListCore_method](#) 302
[proc_GetDocsMetaInfo_method](#) 304
[proc_GetLinkInfoSingleDoc_method](#) 312
[proc_GetListCheckedOutFiles_method](#) 312
[proc_GetListFields_method](#) 313
[proc_GetListMetaDataAndEventReceivers_method](#)
 314
[proc_GetNewListItemId_method](#) 474

[proc_getObject method](#) 316
[proc_getObjectsByBaseClass method](#) 317
[proc_getObjectsByClass method](#) 318
[proc_GetSiteDenyPermMask method](#) 473
[proc_GetSiteFlags method](#) 319
[proc_getSiteMap method](#) 319
[proc_getSiteMapById method](#) 320
[proc_GetTpWebMetaDataAndListMetaData method](#)
322
[proc_GetUniqueScopesInList method](#) 334
[proc_GetVersion method](#) 335
[proc_GetWebMetaInfo method](#) 336
[proc_GetWebMetaInfoByUrl method](#) 338
[proc_HasCurrentPublishVersion method](#) 473
[proc_ListDocumentVersions method](#) 341
[proc_ListRbsStores method](#) 343
[proc_ListUrls method](#) 343
[proc_ReadStream method](#) 263
[proc_RenameUrl method](#) 354
[proc_SecAddPrincipalToRole method](#) 358
[proc_SecAddRoleDef method](#) 359
[proc_SecAddUser method](#) 360
[proc_SecAddUserToSiteGroup method](#) 363
[proc_SecAddWebMembership method](#) 364
[proc_SecChangeToInheritedList method](#) 365
[proc_SecChangeToInheritedWeb method](#) 365
[proc_SecChangeToUniqueScope method](#) 366
[proc_SecCheckDeletedAccounts method](#) 368
[proc_SecCloneRoleDefinitions method](#) 369
[proc_SecCreateSiteGroup method](#) 370
[proc_SecDecCurrentUsersCount method](#) 372
[proc_SecGetAccountStatus method](#) 372
[proc_SecGetAclFromScope method](#) 373
[proc_SecGetAllAclsForSite method](#) 374
[proc_SecGetAllGroupsAndMembershipInfo method](#)
374
[proc_SecGetApplicationPrincipalAndUserToken](#)
[method](#) 376
[proc_SecGetCompleteWebRoleMemberList method](#)
377
[proc_SecGetCurrentUsersCount method](#) 378
[proc_SecGetDomainGroupMapData method](#) 379
[proc_SecGetGroupById method](#) 380
[proc_SecGetGroupOwner method](#) 381
[proc_SecGetGroupSecurityScopes method](#) 381
[proc_SecGetIndividualUrlSecurityCheckEventReceiv](#)
[ers method](#) 382
[proc_SecGetItemsWithUniquePermissions method](#)
384
[proc_SecGetPrincipalByEmail method](#) 386
[proc_SecGetPrincipalById method](#) 386
[proc_SecGetPrincipalByIdEx method](#) 388
[proc_SecGetPrincipalByLogin method](#) 390
[proc_SecGetPrincipalByLogin20 method](#) 391
[proc_SecGetPrincipalDisplayInformation20 method](#)
392
[proc_SecGetRoleAssignments method](#) 395
[proc_SecGetRoleBindingsForAllPrincipals method](#)
396
[proc_SecGetRoleDefs method](#) 396
[proc_SecGetSecurityInfo method](#) 397
[proc_SecGetSiteAdmins method](#) 399
[proc_SecGetSiteGroupById method](#) 400
[proc_SecGetSiteGroupByTitle method](#) 400
[proc_SecGetSiteGroupByTitle20 method](#) 401
[proc_SecGetUserAccountDirectoryPath method](#) 402
[proc_SecGetUserPermissionOnGroup method](#) 402
[proc_SecGetWebsAndListWithUniquePermissions](#)
[method](#) 403
[proc_SecListAllSiteMembers method](#) 406
[proc_SecListAllWebMembers method](#) 407
[proc_SecListGroupsInRole method](#) 408
[proc_SecListScopeGroups method](#) 408
[proc_SecListScopeUsers method](#) 409
[proc_SecListSiteGroupMembership method](#) 410
[proc_SecListSiteGroups method](#) 411
[proc_SecListSiteGroupsContainingUser method](#) 411
[proc_SecListSiteGroupsWhichUserOwns method](#)
412
[proc_SecListUsersInRole method](#) 412
[proc_SecMarkGroupForWebDelete method](#) 417
[proc_SecMigrateUser method](#) 413
[proc_SecReCalculateWebFGP method](#) 414
[proc_SecRefreshToken method](#) 415
[proc_SecRemoveGroup method](#) 416
[proc_SecRemovePrincipalFromScope method](#) 418
[proc_SecRemoveRoleDef method](#) 420
[proc_SecRemoveUserFromScopeByLogin method](#)
420
[proc_SecRemoveUserFromSite method](#) 421
[proc_SecRemoveUserFromSiteGroup method](#) 422
[proc_SecRemoveUserFromSiteGroupByLogin](#)
[method](#) 423
[proc_SecResetItemPerm method](#) 425
[proc_SecResetWebToDefaultRoleDefinition method](#)
426
[proc_SecResolvePrincipal method](#) 427
[proc_SecSetSiteGroupProperties method](#) 429
[proc_SecSetUserAccountDirectoryPath method](#) 431
[proc_SecSetWebRequestAccess method](#) 432
[proc_SecUpdateAnonymousPermMask method](#) 432
[proc_SecUpdateDomainGroupMapData method](#) 433
[proc_SecUpdateRoleDef method](#) 434
[proc_SecUpdateUser method](#) 435
[proc_SecUpdateUserActiveStatus method](#) 436
[proc_SetStreamsToDoc method](#) 468
[proc_SetStreamsToDocNoTVP method](#) 469
[proc_TakeOverCheckout method](#) 436
[proc_UncheckoutDocument method](#) 437
[proc_UpdateDiskUsed method](#) 474
[proc_UpdateDocBuildDependencySet method](#) 439
[proc_UpdateDocument method](#) 440
[proc_UpdateListItem method](#) 446
[proc_UpdateListSettings method](#) 452
[proc_UpdateUserInfoInTableFromRowUpdater](#)
[method](#) 457
[proc_UrlToWebUrl method](#) 458
[proc_WriteChunkToAllDocStreams method](#) 459
[proc_WriteStreams method](#) 465
[proc_WriteStreamToRBS method](#) 464
[proc_WriteStreamToSQL method](#) 466
[Product behavior](#) 500

R

[References](#) 20

[informative](#) 21

[normative](#) 20

[Relationship to other protocols](#) 22

[RelationshipDeleteBehaviorAttribute - simple type](#)
196

Result sets - messages

[ACL and Permission](#) 60

[App Principal Information](#) 95

[App Principal Permissions](#) 95

[Custom Actions From Scope](#) 60

[Document Content Metadata](#) 62

[Document Content Stream](#) 64

[Document Metadata](#) 64

[Document Version Metadata](#) 68

[Domain Group Cache BEDS Update](#) 61

[Domain Group Cache Versions](#) 61

[Domain Group Cache WFE Update](#) 62

[Empty](#) 73

[Event Receivers](#) 73

[Individual URL Security](#) 75

[Link Information](#) 77

[List Metadata](#) 78

[List Related Fields](#) 94

[List Web Parts](#) 82

[NULL Individual URL Security](#) 83

[NULL Unique Permissions](#) 84

[Object ID](#) 85

[Principal User Information](#) 85

[Server Time](#) 85

[Single Doc Link Information](#) 86

[Site Audit Mask](#) 87

[Site Feature List](#) 87

[Site Metadata](#) 87

[Site MetaInfo](#) 93

[Unique Permissions](#) 94

[URL](#) 94

[Result sets - overview](#) 60

S

Security

[implementer considerations](#) 497

[parameter index](#) 497

[Security - add user to document library via object model example](#) 483

[Security - break web inheritance OM example](#) 485

Sequencing rules

[client](#) 476

[server](#) 220

Server

[abstract data model](#) 219

[fn_GetFullUrl method](#) 229

[higher-layer triggered events](#) 220

[initialization](#) 220

[local events](#) 475

[message processing](#) 220

[proc_AddBuildDependency method](#) 230

[proc_AddDocument method](#) 230

[proc_AddListItem method](#) 235

[proc_ChangeLevelForDoc method](#) 241

[proc_CheckoutDocument method](#) 243

[proc_CheckRbsInstalled method](#) 242

[proc_ClearLinks method](#) 246

[proc_CreateDir method](#) 247

[proc_DeleteAllDocumentVersions method](#) 249

[proc_DeleteDocBuildDependencySet method](#) 251

[proc_DeleteDocumentVersion method](#) 251

[proc_DeleteUrl method](#) 252

[proc_DirtyDependents method](#) 256

[proc_DisableRbs method](#) 256

[proc_EnableRbs method](#) 257

[proc_EnumLists method](#) 258

[proc_FetchDocForHttpGet method](#) 264

[proc_FetchDocForRead method](#) 285

[proc_FetchDocForUpdate method](#) 291

[proc_FetchWelcomeNames method](#) 298

[proc_GenerateNextId method](#) 298

[proc_GetAllRolesForUser method](#) 299

[proc_GetAuditMask method](#) 300

[proc_GetAuditMaskOutput method](#) 300

[proc_GetContainingList method](#) 301

[proc_GetContainingListCore method](#) 302

[proc_GetDocsMetaInfo method](#) 304

[proc_GetLinkInfoSingleDoc method](#) 312

[proc_GetListCheckedOutFiles method](#) 312

[proc_GetListFields method](#) 313

[proc_GetListMetaDataAndEventReceivers method](#)
314

[proc_GetNewListItemId method](#) 474

[proc_getObject method](#) 316

[proc_getObjectsByBaseClass method](#) 317

[proc_getObjectsByClass method](#) 318

[proc_GetSiteDenyPermMask method](#) 473

[proc_GetSiteFlags method](#) 319

[proc_getSiteMap method](#) 319

[proc_getSiteMapById method](#) 320

[proc_GetTpWebMetaDataAndListMetaData method](#) 322

[proc_GetUniqueScopesInList method](#) 334

[proc_GetVersion method](#) 335

[proc_GetWebMetaInfo method](#) 336

[proc_GetWebMetaInfoByUrl method](#) 338

[proc_HasCurrentPublishVersion method](#) 473

[proc_ListDocumentVersions method](#) 341

[proc_ListRbsStores method](#) 343

[proc_ListUrls method](#) 343

[proc_ReadStream method](#) 263

[proc_RenameUrl method](#) 354

[proc_SecAddPrincipalToRole method](#) 358

[proc_SecAddRoleDef method](#) 359

[proc_SecAddUser method](#) 360

[proc_SecAddUserToSiteGroup method](#) 363

[proc_SecAddWebMembership method](#) 364

[proc_SecChangeToInheritedList method](#) 365

[proc_SecChangeToInheritedWeb method](#) 365

[proc_SecChangeToUniqueScope method](#) 366

[proc_SecCheckDeletedAccounts method](#) 368

[proc_SecCloneRoleDefinitions method](#) 369

[proc_SecCreateSiteGroup method](#) 370

[proc_SecDecCurrentUsersCount_method](#) 372
[proc_SecGetAccountStatus_method](#) 372
[proc_SecGetAclFromScope_method](#) 373
[proc_SecGetAllAclsForSite_method](#) 374
[proc_SecGetAllGroupsAndMembershipInfo_method](#) 374
[proc_SecGetApplicationPrincipalAndUserToken_method](#) 376
[proc_SecGetCompleteWebRoleMemberList_method](#) 377
[proc_SecGetCurrentUsersCount_method](#) 378
[proc_SecGetDomainGroupMapData_method](#) 379
[proc_SecGetGroupById_method](#) 380
[proc_SecGetGroupOwner_method](#) 381
[proc_SecGetGroupSecurityScopes_method](#) 381
[proc_SecGetIndividualUrlSecurityCheckEventReceivers_method](#) 382
[proc_SecGetItemsWithUniquePermissions_method](#) 384
[proc_SecGetPrincipalByEmail_method](#) 386
[proc_SecGetPrincipalById_method](#) 386
[proc_SecGetPrincipalByIdEx_method](#) 388
[proc_SecGetPrincipalByLogin_method](#) 390
[proc_SecGetPrincipalByLogin20_method](#) 391
[proc_SecGetPrincipalDisplayInformation20_method](#) 392
[proc_SecGetRoleAssignments_method](#) 395
[proc_SecGetRoleBindingsForAllPrincipals_method](#) 396
[proc_SecGetRoleDefs_method](#) 396
[proc_SecGetSecurityInfo_method](#) 397
[proc_SecGetSiteAdmins_method](#) 399
[proc_SecGetSiteGroupById_method](#) 400
[proc_SecGetSiteGroupByTitle_method](#) 400
[proc_SecGetSiteGroupByTitle20_method](#) 401
[proc_SecGetUserAccountDirectoryPath_method](#) 402
[proc_SecGetUserPermissionOnGroup_method](#) 402
[proc_SecGetWebsAndListWithUniquePermissions_method](#) 403
[proc_SecListAllSiteMembers_method](#) 406
[proc_SecListAllWebMembers_method](#) 407
[proc_SecListGroupsInRole_method](#) 408
[proc_SecListScopeGroups_method](#) 408
[proc_SecListScopeUsers_method](#) 409
[proc_SecListSiteGroupMembership_method](#) 410
[proc_SecListSiteGroups_method](#) 411
[proc_SecListSiteGroupsContainingUser_method](#) 411
[proc_SecListSiteGroupsWhichUserOwns_method](#) 412
[proc_SecListUsersInRole_method](#) 412
[proc_SecMarkGroupForWebDelete_method](#) 417
[proc_SecMigrateUser_method](#) 413
[proc_SecReCalculateWebFGP_method](#) 414
[proc_SecRefreshToken_method](#) 415
[proc_SecRemoveGroup_method](#) 416
[proc_SecRemovePrincipalFromScope_method](#) 418
[proc_SecRemoveRoleDef_method](#) 420
[proc_SecRemoveUserFromScopeByLogin_method](#) 420
[proc_SecRemoveUserFromSite_method](#) 421
[proc_SecRemoveUserFromSiteGroup_method](#) 422
[proc_SecRemoveUserFromSiteGroupByLogin_method](#) 423
[proc_SecResetItemPerm_method](#) 425
[proc_SecResetWebToDefaultRoleDefinition_method](#) 426
[proc_SecResolvePrincipal_method](#) 427
[proc_SecSetSiteGroupProperties_method](#) 429
[proc_SecSetUserAccountDirectoryPath_method](#) 431
[proc_SecSetWebRequestAccess_method](#) 432
[proc_SecUpdateAnonymousPermMask_method](#) 432
[proc_SecUpdateDomainGroupMapData_method](#) 433
[proc_SecUpdateRoleDef_method](#) 434
[proc_SecUpdateUser_method](#) 435
[proc_SecUpdateUserActiveStatus_method](#) 436
[proc_SetStreamsToDoc_method](#) 468
[proc_SetStreamsToDocNoTVP_method](#) 469
[proc_TakeOverCheckOut_method](#) 436
[proc_UncheckoutDocument_method](#) 437
[proc_UpdateDiskUsed_method](#) 474
[proc_UpdateDocBuildDependencySet_method](#) 439
[proc_UpdateDocument_method](#) 440
[proc_UpdateListItem_method](#) 446
[proc_UpdateListSettings_method](#) 452
[proc_UpdateUserInfoInTableFromRowUpdater_method](#) 457
[proc_UrlToWebUrl_method](#) 458
[proc_WriteChunkToAllDocStreams_method](#) 459
[proc_WriteStreams_method](#) 465
[proc_WriteStreamToRBS_method](#) 464
[proc_WriteStreamToSQL_method](#) 466
[sequencing_rules](#) 220
[timer_events](#) 475
[timers](#) 220
[TVF_Docs_Url_Level_method](#) 471
[TVF_UserData_ListItemLevelRow_method](#) 471
[TVF_UserData_Pid_Did_Level_Row_method](#) 472
[Server Time result set](#) 85
Simple types
[FALSE_Case_Insensitive_Else_Anything](#) 190
[FieldAggregationAttribute](#) 192
[FieldInternalType](#) 190
[FieldRefType](#) 193
[FieldRichTextMode](#) 193
[IMEMode](#) 194
[IntPositive](#) 194
[JoinType](#) 194
[RelationshipDeleteBehaviorAttribute](#) 196
[TextDirection](#) 194
[TRUE_Case_Sensitive_Else_Anything](#) 195
[TRUE_If_Present](#) 195
[TRUEFALSE](#) 195
[UniqueIdentifierWithBracesUppercase](#) 195
[UniqueIdentifierWithOrWithoutBraces](#) 196
[Single Doc Link Information result set](#) 86
[Site Audit Mask result set](#) 87

[Site collection lookup – alternate URL matching example](#) 488
[Site collection lookup – building content database connection string example](#) 491
[Site collection lookup – prefix matching example](#) 489
[Site collection lookup – retrieving the alternate URL collection identifiers example](#) 487
[Site collection lookup – retrieving the alternate URL collections example](#) 487
[Site collection lookup – retrieving the farm identifier example](#) 486
[Site collection lookup – retrieving the web application identifiers example](#) 488
[Site collection lookup – retrieving the web applications example](#) 489
[Site collection lookup – retrieving the web service identifiers example](#) 488
[Site collection lookup – site collection identifier lookup example](#) 490
[Site collection lookup – web application lookup example](#) 489
[Site collection lookup example](#) 486
[Site Feature List result set](#) 87
[Site Metadata result set](#) 87
[Site MetaInfo result set](#) 93
[Standards assignments](#) 23
Structures
 [XML](#) 190

T

[TextDirection - simple type](#) 194
Timer events
 [client](#) 476
 [server](#) 475
Timers
 [client](#) 476
 [server](#) 220
[Token Group Offset and Attributes binary structure](#) 55
[Token Groups binary structure](#) 56
[Tracking changes](#) 501
[Transport](#) 24
Triggered events - higher-layer
 [client](#) 476
 [server](#) 220
[TRUE Case Sensitive Else Anything - simple type](#) 195
[TRUE If Present - simple type](#) 195
[TRUEFALSE - simple type](#) 195
[TVF Docs Url Level method](#) 471
[TVF UserData ListItemLevelRow method](#) 471
[TVF UserData Pid DIId Level Row method](#) 472

U

[Unique Permissions result set](#) 94
[UniqueIdentifierWithBracesUppercase - simple type](#) 195
[UniqueIdentifierWithOrWithoutBraces - simple type](#) 196

[URL result set](#) 94
[User update user properties OM example](#) 492

V

[Vendor-extensible fields](#) 23
[Version negotiation example](#) 495
[Versioning](#) 23

W

[WSS ACE binary structure](#) 56
[WSS ACL Format binary structure](#) 57
[WSS Compressed Structures binary structure](#) 58
[WSS External Group Map Cache Format binary structure](#) 57
[WSS External Group Record binary structure](#) 59
[WSS User Token binary structure](#) 59

X

[XML structures](#) 190