

[MS-CONFBAS]:

Centralized Conference Control Protocol: Basic Architecture and Signaling

Intellectual Property Rights Notice for Open Specifications Documentation

- **Technical Documentation.** Microsoft publishes Open Specifications documentation (“this documentation”) for protocols, file formats, data portability, computer languages, and standards support. Additionally, overview documents cover inter-protocol relationships and interactions.
- **Copyrights.** This documentation is covered by Microsoft copyrights. Regardless of any other terms that are contained in the terms of use for the Microsoft website that hosts this documentation, you can make copies of it in order to develop implementations of the technologies that are described in this documentation and can distribute portions of it in your implementations that use these technologies or in your documentation as necessary to properly document the implementation. You can also distribute in your implementation, with or without modification, any schemas, IDLs, or code samples that are included in the documentation. This permission also applies to any documents that are referenced in the Open Specifications documentation.
- **No Trade Secrets.** Microsoft does not claim any trade secret rights in this documentation.
- **Patents.** Microsoft has patents that might cover your implementations of the technologies described in the Open Specifications documentation. Neither this notice nor Microsoft's delivery of this documentation grants any licenses under those patents or any other Microsoft patents. However, a given Open Specifications document might be covered by the Microsoft [Open Specifications Promise](#) or the [Microsoft Community Promise](#). If you would prefer a written license, or if the technologies described in this documentation are not covered by the Open Specifications Promise or Community Promise, as applicable, patent licenses are available by contacting iplg@microsoft.com.
- **License Programs.** To see all of the protocols in scope under a specific license program and the associated patents, visit the [Patent Map](#).
- **Trademarks.** The names of companies and products contained in this documentation might be covered by trademarks or similar intellectual property rights. This notice does not grant any licenses under those rights. For a list of Microsoft trademarks, visit www.microsoft.com/trademarks.
- **Fictitious Names.** The example companies, organizations, products, domain names, email addresses, logos, people, places, and events that are depicted in this documentation are fictitious. No association with any real company, organization, product, domain name, email address, logo, person, place, or event is intended or should be inferred.

Reservation of Rights. All other rights are reserved, and this notice does not grant any rights other than as specifically described above, whether by implication, estoppel, or otherwise.

Tools. The Open Specifications documentation does not require the use of Microsoft programming tools or programming environments in order for you to develop an implementation. If you have access to Microsoft programming tools and environments, you are free to take advantage of them. Certain Open Specifications documents are intended for use in conjunction with publicly available standards specifications and network programming art and, as such, assume that the reader either is familiar with the aforementioned material or has immediate access to it.

Support. For questions and support, please contact dochelp@microsoft.com.

Preliminary Documentation. This particular Open Specifications document provides documentation for past and current releases and/or for the pre-release version of this technology. This document provides final documentation for past and current releases and preliminary documentation, as applicable and specifically noted in this document, for the pre-release version. Microsoft will release final documentation in connection with the commercial release of the updated or new version of this

technology. Because this documentation might change between the pre-release version and the final version of this technology, there are risks in relying on this preliminary documentation. To the extent that you incur additional development obligations or any other costs as a result of relying on this preliminary documentation, you do so at your own risk.

Preliminary

Revision Summary

| Date | Revision History | Revision Class | Comments |
|------------|------------------|----------------|--|
| 4/4/2008 | 0.1 | New | Initial Availability |
| 4/25/2008 | 0.2 | Editorial | Revised and edited the technical content |
| 6/27/2008 | 1.0 | Major | Revised and edited the technical content |
| 8/15/2008 | 1.01 | Editorial | Revised and edited the technical content |
| 12/12/2008 | 1.01 | Editorial | Revised and edited the technical content |
| 2/13/2009 | 2.01 | Major | Revised and edited the technical content |
| 3/13/2009 | 2.02 | Editorial | Edited the technical content |
| 7/13/2009 | 2.03 | Major | Revised and edited the technical content |
| 8/28/2009 | 2.04 | Editorial | Revised and edited the technical content |
| 11/6/2009 | 2.05 | Minor | Revised and edited the technical content |
| 2/19/2010 | 2.06 | Editorial | Revised and edited the technical content |
| 3/31/2010 | 2.07 | Major | Updated and revised the technical content |
| 4/30/2010 | 2.08 | Editorial | Revised and edited the technical content |
| 6/7/2010 | 2.09 | Editorial | Revised and edited the technical content |
| 6/29/2010 | 2.10 | Editorial | Changed language and formatting in the technical content. |
| 7/23/2010 | 2.10 | None | No changes to the meaning, language, or formatting of the technical content. |
| 9/27/2010 | 3.0 | Major | Significantly changed the technical content. |
| 11/15/2010 | 3.0 | None | No changes to the meaning, language, or formatting of the technical content. |
| 12/17/2010 | 3.0 | None | No changes to the meaning, language, or formatting of the technical content. |
| 3/18/2011 | 3.0 | None | No changes to the meaning, language, or formatting of the technical content. |
| 6/10/2011 | 3.0 | None | No changes to the meaning, language, or formatting of the technical content. |
| 1/20/2012 | 4.0 | Major | Significantly changed the technical content. |
| 4/11/2012 | 4.0 | None | No changes to the meaning, language, or formatting of the technical content. |
| 7/16/2012 | 4.0 | None | No changes to the meaning, language, or formatting of the technical content. |
| 10/8/2012 | 5.0 | Major | Significantly changed the technical content. |
| 2/11/2013 | 6.0 | Major | Significantly changed the technical content. |
| 7/30/2013 | 6.1 | Minor | Clarified the meaning of the technical content. |

| Date | Revision History | Revision Class | Comments |
|-------------|-------------------------|-----------------------|--|
| 11/18/2013 | 7.0 | Major | Significantly changed the technical content. |
| 2/10/2014 | 7.0 | None | No changes to the meaning, language, or formatting of the technical content. |
| 4/30/2014 | 7.1 | Minor | Clarified the meaning of the technical content. |
| 7/31/2014 | 7.2 | Minor | Clarified the meaning of the technical content. |
| 10/30/2014 | 7.3 | Minor | Clarified the meaning of the technical content. |
| 3/30/2015 | 8.0 | Major | Significantly changed the technical content. |
| 9/4/2015 | 8.0 | None | No changes to the meaning, language, or formatting of the technical content. |
| 7/15/2016 | 8.0 | None | No changes to the meaning, language, or formatting of the technical content. |
| 9/14/2016 | 8.0 | None | No changes to the meaning, language, or formatting of the technical content. |
| 6/20/2017 | 9.0 | Major | Significantly changed the technical content. |
| 4/27/2018 | 10.0 | Major | Significantly changed the technical content. |
| 7/24/2018 | 11.0 | Major | Significantly changed the technical content. |

Table of Contents

| | | |
|-----------|---|-----------|
| 1 | Introduction | 11 |
| 1.1 | Glossary | 11 |
| 1.2 | References | 14 |
| 1.2.1 | Normative References | 14 |
| 1.2.2 | Informative References | 15 |
| 1.3 | Overview | 16 |
| 1.3.1 | Architecture and Background | 16 |
| 1.3.2 | End-to-End Call Flow Overview | 18 |
| 1.3.3 | Inter-Component Protocols | 20 |
| 1.3.3.1 | Browser to Join Manager | 20 |
| 1.3.3.2 | Client to Focus Factory | 21 |
| 1.3.3.3 | Client to Focus | 21 |
| 1.3.4 | Scope of this document | 21 |
| 1.4 | Relationship to Other Protocols | 21 |
| 1.5 | Prerequisites/Preconditions | 21 |
| 1.6 | Applicability Statement | 22 |
| 1.7 | Versioning and Capability Negotiation | 22 |
| 1.8 | Vendor-Extensible Fields | 22 |
| 1.9 | Standards Assignments | 22 |
| 2 | Messages | 23 |
| 2.1 | Transport | 23 |
| 2.1.1 | HTTP Transport | 23 |
| 2.1.2 | SIP Transport | 23 |
| 2.2 | Message Syntax | 23 |
| 2.2.1 | Focus Signaling Messages | 23 |
| 2.2.1.1 | Common Signaling Header Formats | 23 |
| 2.2.1.2 | Signaling Dialog Establishment Message | 24 |
| 2.2.1.3 | Signaling Dialog Update Message | 24 |
| 2.2.1.4 | Signaling Dialog Teardown Message | 24 |
| 2.2.1.5 | Conference Control Messages | 25 |
| 2.2.2 | Focus Subscription Messages | 25 |
| 2.2.2.1 | Subscription Establishment Messages | 25 |
| 2.2.2.2 | Extensions to the application/conference-info+xml Document Format | 25 |
| 2.2.2.3 | conference-description Extensions | 27 |
| 2.2.2.4 | Extensions to conf-uris Element Semantics | 30 |
| 2.2.2.5 | Extensions to roles Element Semantics | 30 |
| 2.2.2.6 | endpoint Element Extensions | 30 |
| 2.2.2.7 | conference-view Element Extensions | 32 |
| 2.2.2.8 | supported-content-type Element Extension | 33 |
| 2.2.2.9 | data-mcu-state Element Extensions | 33 |
| 2.2.2.10 | permission-options Element Extensions | 34 |
| 2.2.2.11 | permissions Element Extensions | 34 |
| 2.2.2.12 | application/cccp+xml Document Format | 35 |
| 2.2.3 | C3P Request and Response Document Formats | 36 |
| 2.2.3.1 | Requests | 36 |
| 2.2.3.1.1 | request Element | 36 |
| 2.2.3.1.2 | conferenceKeys Element | 36 |
| 2.2.3.1.3 | userKeys Element | 36 |
| 2.2.3.1.4 | endpointKeys element | 37 |
| 2.2.3.1.5 | mediaKeys Element | 37 |
| 2.2.3.2 | Responses | 37 |
| 2.2.3.2.1 | response Element | 37 |
| 2.2.3.2.2 | diagnostics-info Subelement | 38 |
| 2.2.3.3 | addUser Request Document Format for Focus INVITE Requests | 39 |

| | | |
|-----------|---|-----------|
| 2.2.3.4 | addUser Response Document Format for Focus INVITE Responses | 40 |
| 2.2.3.5 | endorseUser Request Document Format for Focus INVITE Requests | 40 |
| 2.2.3.6 | endorseUser Response Document Format for Focus INVITE Responses | 41 |
| 2.2.3.7 | modifyUserRoles Request Document..... | 41 |
| 2.2.3.8 | modifyUserRoles Response Document | 42 |
| 2.2.3.9 | modifyConferenceLock Request Document | 42 |
| 2.2.3.10 | modifyConferenceLock Response Document | 43 |
| 2.2.3.11 | deleteUser Request Document | 44 |
| 2.2.3.12 | deleteUser Response Document | 44 |
| 2.2.3.13 | deleteConference Request Document..... | 45 |
| 2.2.3.14 | deleteConference Response Document..... | 45 |
| 2.2.3.15 | addUser Dial-out Request Document | 45 |
| 2.2.3.16 | addUser Dial-out Response Document | 46 |
| 2.2.3.17 | addUser Dial-in Request Document | 47 |
| 2.2.3.18 | addUser Dial-in Response Document | 48 |
| 2.2.3.19 | getConference Request Document..... | 50 |
| 2.2.3.20 | getConference Response Document..... | 50 |
| 2.2.3.21 | setLobbyAccess Request Document | 50 |
| 2.2.3.22 | setLobbyAccess Response Document | 51 |
| 2.2.3.23 | modifyEndpoint Request Document | 51 |
| 2.2.3.24 | modifyEndpoint Response Document | 51 |
| 2.2.3.25 | modifyConferenceAnnouncements Request Document | 52 |
| 2.2.3.26 | modifyConferenceAnnouncements Response Document | 52 |
| 2.2.3.27 | modifyConference Request Document..... | 52 |
| 2.2.3.28 | modifyConference Response Document..... | 52 |
| 2.2.4 | Conference Roster Document Format | 52 |
| 2.2.4.1 | conference-description Element Syntax..... | 53 |
| 2.2.4.2 | Participant user Element Syntax | 53 |
| 2.2.4.2.1 | Focus endpoint Element Syntax..... | 53 |
| 2.2.4.2.2 | MCU endpoint Element Syntax | 54 |
| 2.2.4.3 | Participant-count Attribute Syntax..... | 54 |
| 2.2.4.4 | conference-view Element Syntax | 55 |
| 2.2.4.4.1 | Focus entity-view Element Syntax | 55 |
| 2.2.5 | MCU Conference Roster Document Format..... | 55 |
| 2.2.6 | HTTP Request and Response | 55 |
| 2.2.6.1 | HTTP Request..... | 55 |
| 2.2.6.2 | HTTP Response..... | 56 |
| 2.2.6.3 | ocsmeet Document Format | 56 |
| 2.2.6.4 | Simple Join JavaScript | 57 |
| 3 | Protocol Details..... | 84 |
| 3.1 | Conference Activation and Deactivation Details..... | 84 |
| 3.1.1 | Abstract Data Model..... | 84 |
| 3.1.2 | Timers | 84 |
| 3.1.3 | Initialization..... | 84 |
| 3.1.4 | Higher-Layer Triggered Events | 84 |
| 3.1.4.1 | Activating a Conference | 84 |
| 3.1.4.1.1 | Obtaining MCU-Conference-URIs | 85 |
| 3.1.4.2 | Deactivating a Conference..... | 85 |
| 3.1.5 | Message Processing Events and Sequencing Rules | 85 |
| 3.1.6 | Timer Events..... | 85 |
| 3.1.7 | Other Local Events..... | 85 |
| 3.2 | Joining and Leaving a Conference Details | 85 |
| 3.2.1 | Abstract Data Model..... | 87 |
| 3.2.2 | Timers | 87 |
| 3.2.3 | Initialization..... | 87 |
| 3.2.4 | Higher-Layer Triggered Events | 87 |
| 3.2.4.1 | Client Role | 87 |

| | | |
|-----------|--|-----|
| 3.2.4.1.1 | Constructing the SIP INVITE Request | 87 |
| 3.2.4.1.2 | Joining conference as anonymous user | 88 |
| 3.2.4.2 | Focus Role | 88 |
| 3.2.4.2.1 | Processing the addUser request..... | 89 |
| 3.2.4.2.2 | Processing INVITE from anonymous client | 89 |
| 3.2.5 | Message Processing Events and Sequencing Rules | 89 |
| 3.2.5.1 | Client Role | 89 |
| 3.2.5.2 | Focus Role | 89 |
| 3.2.5.2.1 | Constructing the SIP INVITE Response | 89 |
| 3.2.5.2.2 | Multiple Endpoints Connecting to the Focus | 90 |
| 3.2.5.2.3 | Notifying Watchers When a Participant Joins | 90 |
| 3.2.5.2.4 | SIP Error Response Codes | 90 |
| 3.2.6 | Timer Events..... | 90 |
| 3.2.7 | Other Local Events..... | 90 |
| 3.3 | Endorsing a Participant in a Conference Details..... | 90 |
| 3.3.1 | Abstract Data Model..... | 91 |
| 3.3.2 | Timers | 91 |
| 3.3.3 | Initialization..... | 91 |
| 3.3.4 | Higher-Layer Triggered Events | 91 |
| 3.3.4.1 | Client Role | 91 |
| 3.3.4.2 | Focus Role | 92 |
| 3.3.4.2.1 | Processing the endorseUser request..... | 92 |
| 3.3.5 | Message Processing Events and Sequencing Rules | 92 |
| 3.3.5.1 | Client Role | 92 |
| 3.3.5.2 | Focus Role | 92 |
| 3.3.5.2.1 | SIP Error Response Codes | 92 |
| 3.3.6 | Timer Events..... | 93 |
| 3.3.7 | Other Local Events..... | 93 |
| 3.4 | Conference Subscriptions and Notifications Details | 93 |
| 3.4.1 | Abstract Data Model..... | 94 |
| 3.4.1.1 | Client Role | 94 |
| 3.4.2 | Timers | 95 |
| 3.4.2.1 | Client Role | 95 |
| 3.4.3 | Initialization..... | 95 |
| 3.4.3.1 | Client Role | 95 |
| 3.4.4 | Higher-Layer Triggered Events | 95 |
| 3.4.4.1 | Client Role | 95 |
| 3.4.4.2 | Focus Role | 95 |
| 3.4.4.2.1 | Roster Aggregation Algorithm | 96 |
| 3.4.4.3 | MCU Role | 97 |
| 3.4.4.3.1 | MCU Notifications | 97 |
| 3.4.5 | Message Processing Events and Sequencing Rules | 97 |
| 3.4.5.1 | Client Role | 97 |
| 3.4.5.1.1 | Processing the First Full Notification..... | 97 |
| 3.4.5.2 | Focus Role | 98 |
| 3.4.5.2.1 | Generating a Full Notification Document..... | 98 |
| 3.4.5.2.2 | SIP Error Response Codes | 98 |
| 3.4.6 | Timer Events..... | 98 |
| 3.4.6.1 | Client Role | 98 |
| 3.4.7 | Other Local Events..... | 98 |
| 3.5 | Common Conference Control Details..... | 99 |
| 3.5.1 | Abstract Data Model..... | 100 |
| 3.5.1.1 | Client Role | 100 |
| 3.5.1.2 | Focus Role | 100 |
| 3.5.2 | Timers | 100 |
| 3.5.2.1 | Client Role | 100 |
| 3.5.3 | Initialization..... | 101 |
| 3.5.3.1 | Client Role | 101 |

| | | |
|-------------|---|-----|
| 3.5.4 | Higher-Layer Triggered Events | 101 |
| 3.5.4.1 | Client Role | 101 |
| 3.5.4.1.1 | Sending a Conference Control Request | 101 |
| 3.5.4.2 | Focus Role | 101 |
| 3.5.4.2.1 | Receiving a Conference Control Request | 101 |
| 3.5.4.2.2 | Authorizing a Conference Control Request | 101 |
| 3.5.4.2.3 | Processing a Command | 102 |
| 3.5.4.2.3.1 | SIP Response Codes | 102 |
| 3.5.4.2.3.2 | Common C3P Failure Response Codes | 102 |
| 3.5.5 | Message Processing Events and Sequencing Rules | 103 |
| 3.5.5.1 | Client Role | 103 |
| 3.5.5.1.1 | Receiving SIP 202 Response to the INFO Request | 103 |
| 3.5.5.1.2 | Receiving SIP 200 Response to the INFO Request | 103 |
| 3.5.5.1.3 | Receiving an INFO Request From the Focus | 103 |
| 3.5.5.1.4 | Processing a Command Response | 103 |
| 3.5.5.1.5 | Processing Incoming Notifications | 104 |
| 3.5.5.2 | Focus Role | 104 |
| 3.5.5.2.1 | Forwarding Command to an MCU | 104 |
| 3.5.5.2.2 | Forking Command to All MCUs | 104 |
| 3.5.5.2.3 | Completing Command Processing | 104 |
| 3.5.6 | Timer Events | 105 |
| 3.5.6.1 | Client Role | 105 |
| 3.5.6.2 | Focus Role | 105 |
| 3.5.7 | Other Local Events | 105 |
| 3.6 | Conference Control – modifyConferenceLock Command Details | 105 |
| 3.6.1 | Abstract Data Model | 105 |
| 3.6.1.1 | Focus Role | 105 |
| 3.6.2 | Timers | 106 |
| 3.6.3 | Initialization | 106 |
| 3.6.4 | Higher-Layer Triggered Events | 106 |
| 3.6.5 | Message Processing Events and Sequencing Rules | 106 |
| 3.6.6 | Timer Events | 106 |
| 3.6.7 | Other Local Events | 106 |
| 3.7 | Conference Control – modifyUserRoles Command Details | 106 |
| 3.7.1 | Abstract Data Model | 106 |
| 3.7.1.1 | Focus Role | 106 |
| 3.7.2 | Timers | 107 |
| 3.7.3 | Initialization | 107 |
| 3.7.4 | Higher-Layer Triggered Events | 107 |
| 3.7.5 | Message Processing Events and Sequencing Rules | 107 |
| 3.7.6 | Timer Events | 107 |
| 3.7.7 | Other Local Events | 107 |
| 3.8 | Conference Control – deleteUser Command Details | 107 |
| 3.8.1 | Abstract Data Model | 107 |
| 3.8.2 | Timers | 107 |
| 3.8.3 | Initialization | 107 |
| 3.8.4 | Higher-Layer Triggered Events | 107 |
| 3.8.5 | Message Processing Events and Sequencing Rules | 108 |
| 3.8.5.1 | Focus Role | 108 |
| 3.8.6 | Timer Events | 108 |
| 3.8.7 | Other Local Events | 108 |
| 3.9 | Conference Control – deleteConference Command Details | 108 |
| 3.9.1 | Abstract Data Model | 108 |
| 3.9.2 | Timers | 109 |
| 3.9.3 | Initialization | 109 |
| 3.9.4 | Higher-Layer Triggered Events | 109 |
| 3.9.5 | Message Processing Events and Sequencing Rules | 109 |
| 3.9.6 | Timer Events | 109 |

| | | |
|------------|---|-----|
| 3.9.7 | Other Local Events..... | 109 |
| 3.10 | Conference Control – addUser Dial-out Command Details..... | 109 |
| 3.10.1 | Abstract Data Model..... | 110 |
| 3.10.2 | Timers | 110 |
| 3.10.3 | Initialization..... | 110 |
| 3.10.4 | Higher-Layer Triggered Events | 110 |
| 3.10.4.1 | MCU Role | 110 |
| 3.10.4.1.1 | Constructing an Outgoing SIP INVITE Request | 110 |
| 3.10.5 | Message Processing Events and Sequencing Rules | 111 |
| 3.10.5.1 | MCU Role..... | 111 |
| 3.10.6 | Timer Events..... | 111 |
| 3.10.7 | Other Local Events..... | 111 |
| 3.11 | Conference Control – addUser Dial-in Command Details..... | 111 |
| 3.11.1 | Abstract Data Model..... | 113 |
| 3.11.2 | Timers | 113 |
| 3.11.3 | Initialization..... | 113 |
| 3.11.4 | Higher-Layer Triggered Events | 113 |
| 3.11.4.1 | Client Role | 113 |
| 3.11.4.1.1 | Constructing an Outgoing addUser Dial-in Request | 113 |
| 3.11.4.2 | MCU Role | 113 |
| 3.11.5 | Message Processing Events and Sequencing Rules | 113 |
| 3.11.5.1 | Client Role | 113 |
| 3.11.5.1.1 | Processing an addUser Dial-in Response..... | 113 |
| 3.11.5.1.2 | Constructing an Outgoing SIP INVITE Request | 113 |
| 3.11.5.2 | MCU Role | 114 |
| 3.11.5.2.1 | Constructing an addUser Dial-in Response..... | 114 |
| 3.11.6 | Timer Events..... | 114 |
| 3.11.7 | Other Local Events..... | 114 |
| 3.12 | Conference Control – getConference Command Details | 114 |
| 3.12.1 | Abstract Data Model..... | 114 |
| 3.12.2 | Timers | 114 |
| 3.12.3 | Initialization..... | 115 |
| 3.12.4 | Higher-Layer Triggered Events | 115 |
| 3.12.4.1 | Focus Role | 115 |
| 3.12.5 | Message Processing Events and Sequencing Rules | 115 |
| 3.12.6 | Timer Events..... | 115 |
| 3.12.7 | Other Local Events..... | 115 |
| 3.13 | Conference Control – modifyEndpoint Command Details | 115 |
| 3.13.1 | Abstract Data Model..... | 116 |
| 3.13.2 | Timers | 116 |
| 3.13.3 | Initialization..... | 116 |
| 3.13.4 | Higher-Layer Triggered Events | 116 |
| 3.13.5 | Message Processing Events and Sequencing Rules | 116 |
| 3.13.6 | Timer Events..... | 116 |
| 3.13.7 | Other Local Events..... | 116 |
| 3.14 | Conference Control – setLobbyAccess Command Details | 116 |
| 3.14.1 | Abstract Data Model..... | 116 |
| 3.14.2 | Timers | 116 |
| 3.14.3 | Initialization..... | 117 |
| 3.14.4 | Higher-Layer Triggered Events | 117 |
| 3.14.4.1 | Focus Role | 117 |
| 3.14.5 | Message Processing Events and Sequencing Rules | 117 |
| 3.14.5.1 | Focus Role | 117 |
| 3.14.6 | Timer Events..... | 118 |
| 3.14.7 | Other Local Events..... | 118 |
| 3.15 | Conference Control – modifyConference Command Details | 118 |
| 3.15.1 | Abstract Data Model..... | 118 |
| 3.15.2 | Timers | 118 |

| | | |
|----------|--|------------|
| 3.15.3 | Initialization | 118 |
| 3.15.4 | Higher-Layer Triggered Events | 118 |
| 3.15.4.1 | MCU Role | 118 |
| 3.15.5 | Message Processing Events and Sequencing Rules | 118 |
| 3.15.6 | Timer Events..... | 118 |
| 3.15.7 | Other Local Events..... | 118 |
| 4 | Protocol Examples | 119 |
| 4.1 | Simple Join | 119 |
| 4.2 | Joining and Leaving a Conference | 122 |
| 4.2.1 | Joining a Conference | 122 |
| 4.2.2 | Updating the Dialog | 125 |
| 4.2.3 | Leaving a Conference | 126 |
| 4.3 | Subscribing to a Conference | 127 |
| 4.3.1 | Establishing a Subscription | 127 |
| 4.3.2 | Terminating the Subscription | 130 |
| 4.4 | Basic Conference Control | 131 |
| 4.4.1 | modifyConferenceLock | 131 |
| 4.4.2 | modifyUserRoles..... | 136 |
| 4.4.3 | deleteUser | 138 |
| 4.4.4 | deleteConference..... | 142 |
| 4.4.5 | addUser Dial-out | 144 |
| 4.4.6 | addUser Dial-in | 147 |
| 4.4.7 | getConference..... | 151 |
| 4.4.8 | setLobbyAccess | 154 |
| 4.4.9 | modifyEndpoint | 157 |
| 4.4.10 | modifyConference..... | 160 |
| 5 | Security | 163 |
| 5.1 | Security Considerations for Implementers | 163 |
| 5.2 | Index of Security Parameters | 163 |
| 6 | Appendix A: Full XML Schema..... | 164 |
| 6.1 | application/vnd.microsoft.ocsmeeting Schema | 164 |
| 6.1.1 | simplejoinconfdoc Namespace | 164 |
| 6.1.2 | simplejoinconfdoc-extensions Namespace | 165 |
| 6.1.3 | simplejoinconfdoc-separator Namespace | 166 |
| 6.2 | application/cccp+xml Schema..... | 166 |
| 6.2.1 | cccp Namespace..... | 166 |
| 6.2.2 | cccpextensions Namespace | 198 |
| 6.3 | application/conference-info+xml Schema | 200 |
| 6.3.1 | conference-info Namespace | 200 |
| 6.3.2 | confinfoextensions Namespace | 208 |
| 6.3.3 | conference-info-separator Namespace..... | 224 |
| 6.3.4 | dataconfinfoextensions Namespace..... | 225 |
| 6.3.5 | avconfinfoextensions Namespace..... | 226 |
| 6.3.6 | imconfinfoextensions Namespace..... | 229 |
| 6.3.7 | acpconfinfoextensions Namespace | 230 |
| 6.3.8 | asconfinfoextensions Namespace | 232 |
| 6.3.9 | commonmceuextensions Namespace | 233 |
| 7 | Appendix B: Product Behavior | 237 |
| 8 | Change Tracking..... | 241 |
| 9 | Index..... | 242 |

1 Introduction

The Centralized Conference Control Protocol (C3P) activates, modifies, deactivates, and controls conferences. This protocol specifies extensions to the general conferencing framework described in [\[RFC4353\]](#). It also defines extensions to the Session Initiation Protocol (SIP) conference state event package. Furthermore, this document describes how the client can be invoked to join a conference via a web browser interface using the conferencing join web URL, which is also referred to as a Simple Join. The protocols defined in the document are used by SIP clients and servers to support conferencing scenarios.

Sections 1.5, 1.8, 1.9, 2, and 3 of this specification are normative. All other sections and examples in this specification are informative.

1.1 Glossary

This document uses the following terms:

200 OK: A response to indicate that the request has succeeded.

202 Accepted: A response that indicates that a request was accepted for processing.

403 Forbidden: A response that indicates that a protocol server understood but denies a request.

ActiveX control: A reusable software control, such as a check box or button, that uses ActiveX technology and provides options to users or runs macros or scripts that automate a task. See also ActiveX object.

Audio/Video Multipoint Control Unit (AVMCU): A **Multipoint Control Unit (MCU)** that supports audio-video (AV) conferencing.

Best Effort NOTIFY (BENOTIFY): A **Session Initiation Protocol (SIP)** method that is used to send notifications to a subscriber, as described in [\[MS-SIP\]](#). Unlike the NOTIFY method, the BENOTIFY method does not require the recipient of the request to send a **SIP response**.

conference: A Real-Time Transport Protocol (RTP) session that includes more than one **participant**.

conference control command: See **conference control request**.

conference control request: A request that is sent by a conference client to modify a conference or the state of a conference participant.

conference store: A database that stores all of the conference-related information for an organization.

conference URI (conference-URI): A **Session Initiation Protocol (SIP) URI** that uniquely identifies the **focus** of a conference.

Content-Type header: A message header field whose value describes the type of data that is in the body of the message.

dialog: A peer-to-peer **Session Initiation Protocol (SIP)** relationship that exists between two user agents and persists for a period of time. A dialog is established by **SIP messages**, such as a 2xx response to an INVITE request, and is identified by a call identifier, a local tag, and a remote tag.

endpoint: A device that is connected to a computer network.

endpoint identifier (EPID): A unique identifier of a Session Initiation Protocol (SIP) **endpoint**. It is formed by combining the value of an epid parameter in a From or To header field with the address-of-record in the corresponding header field.

event package: A specification that defines a set of state information to be reported by a notifying **Session Initiation Protocol (SIP)** client to a subscriber. An event package also defines further syntax and semantics based on the framework that is required to convey such state information.

final response: A Session Initiation Protocol (SIP) response that terminates an SIP transaction. All 2xx, 3xx, 4xx, 5xx, and 6xx responses are final.

first-party request: A **conference control request** that modifies the state of the sending participant only.

focus: A single user agent that maintains a **dialog** and **Session Initiation Protocol (SIP)** signaling relationship with each **participant**, implements conference policies, and ensures that each participant receives the media that comprise the tightly coupled **conference**.

Focus Factory: A component that is responsible for creating, managing, and deleting conferences.

fully qualified domain name (FQDN): An unambiguous domain name that gives an absolute location in the Domain Name System's (DNS) hierarchy tree, as defined in [\[RFC1035\]](#) section 3.1 and [\[RFC2181\]](#) section 11.

Globally Routable User Agent URI (GRUU): A **URI** that identifies a user agent and is globally routable. A URI possesses a GRUU property if it is useable by any **user agent client (UAC)** that is connected to the Internet, routable to a specific user agent instance, and long-lived.

globally unique identifier (GUID): A term used interchangeably with universally unique identifier (UUID) in Microsoft protocol technical documents (TDs). Interchanging the usage of these terms does not imply or require a specific algorithm or mechanism to generate the value. Specifically, the use of this term does not imply or require that the algorithms described in [\[RFC4122\]](#) or [\[C706\]](#) must be used for generating the **GUID**. See also universally unique identifier (UUID).

Hypertext Transfer Protocol (HTTP): An application-level protocol for distributed, collaborative, hypermedia information systems (text, graphic images, sound, video, and other multimedia files) on the World Wide Web.

Hypertext Transfer Protocol Secure (HTTPS): An extension of HTTP that securely encrypts and decrypts web page requests. In some older protocols, "Hypertext Transfer Protocol over Secure Sockets Layer" is still used (Secure Sockets Layer has been deprecated). For more information, see [\[SSL3\]](#) and [\[RFC5246\]](#).

IM MCU: A **Multipoint Control Unit (MCU)** that supports Instant Messaging (IM) conferencing.

in-band provisioning: A process in which a protocol client obtains configuration information from a protocol server.

Internet Protocol version 4 (IPv4): An Internet protocol that has 32-bit source and destination addresses. IPv4 is the predecessor of IPv6.

Internet Protocol version 6 (IPv6): A revised version of the Internet Protocol (IP) designed to address growth on the Internet. Improvements include a 128-bit IP address size, expanded routing capabilities, and support for authentication and privacy.

INVITE: A **Session Initiation Protocol (SIP)** method that is used to invite a user or a service to participate in a session.

lobby: A collection of objects that contains data about one or more participants who are waiting for the organizer or a presenter in a conference to admit participants to the conference.

MCU-Conference-URI: A literal that specifies a URI that can be used to access conferencing services in the context of a **Multipoint Control Unit (MCU)**.

MCU-Type: A literal that identifies all of the media types, such as audio-video, that are supported by a **Multipoint Control Unit (MCU)**.

mixer: An intermediate system that receives a set of media streams of the same type, combines the media in a type-specific manner, and redistributes the result to each **participant**.

Multipoint Control Unit (MCU): A server **endpoint** that offers mixing services for multiparty, multiuser conferencing. An MCU typically supports one or more media types, such as audio, video, and data.

notification: A process in which a subscribing **Session Initiation Protocol (SIP)** client is notified of the state of a subscribed resource by sending a NOTIFY message to the subscriber.

NOTIFY: A method that is used to notify a **Session Initiation Protocol (SIP)** client that an event requested by an earlier SUBSCRIBE method has occurred. The notification optionally provides details about the event.

organizer: The owner or creator of a meeting or appointment.

participant: A user who is participating in a **conference** or peer-to-peer call, or the object that is used to represent that user.

public switched telephone network (PSTN): Public switched telephone network is the voice-oriented public switched telephone network. It is circuit-switched, as opposed to the packet-switched networks.

SERVICE: A method that is defined by **Session Initiation Protocol (SIP)** extensions and is used by an SIP client to request a service from a server.

Session Description Protocol (SDP): A protocol that is used for session announcement, session invitation, and other forms of multimedia session initiation. For more information see [\[MS-SDP\]](#) and [\[RFC3264\]](#).

Session Initiation Protocol (SIP): An application-layer control (signaling) protocol for creating, modifying, and terminating sessions with one or more participants. **SIP** is defined in [\[RFC3261\]](#).

SIP message: The data that is exchanged between **Session Initiation Protocol (SIP)** elements as part of the protocol. An SIP message is either a request or a response.

SIP request: A **Session Initiation Protocol (SIP)** message that is sent from a **user agent client (UAC)** to a **user agent server (UAS)** to call a specific operation.

SIP response: A **Session Initiation Protocol (SIP)** message that is sent from a **user agent server (UAS)** to a **user agent client (UAC)** to indicate the status of a request from the UAC to the UAS.

SUBSCRIBE: A **Session Initiation Protocol (SIP)** method that is used to request asynchronous notification of an event or a set of events at a later time.

subscription: The result of a SUBSCRIBE request from a **Session Initiation Protocol (SIP)** element.

third-party request: A **conference control request** that modifies the state of participants other than the participant who sent the request.

Transmission Control Protocol (TCP): A protocol used with the Internet Protocol (IP) to send data in the form of message units between computers over the Internet. TCP handles keeping track of the individual units of data (called packets) that a message is divided into for efficient routing through the Internet.

Transport Layer Security (TLS): A security protocol that supports confidentiality and integrity of messages in client and server applications communicating over open networks. **TLS** supports server and, optionally, client authentication by using X.509 certificates (as specified in [\[X509\]](#)). **TLS** is standardized in the IETF TLS working group.

Uniform Resource Identifier (URI): A string that identifies a resource. The URI is an addressing mechanism defined in Internet Engineering Task Force (IETF) Uniform Resource Identifier (URI): Generic Syntax [\[RFC3986\]](#).

Uniform Resource Locator (URL): A string of characters in a standardized format that identifies a document or resource on the World Wide Web. The format is as specified in [\[RFC1738\]](#).

user agent client (UAC): A logical entity that creates a new request, and then uses the client transaction state machinery to send it. The role of **UAC** lasts only for the duration of that transaction. In other words, if a piece of software initiates a request, it acts as a **UAC** for the duration of that transaction. If it receives a request later, it assumes the role of a **user agent server (UAS)** for the processing of that transaction.

user agent server (UAS): A logical entity that generates a response to a **Session Initiation Protocol (SIP)** request. The response either accepts, rejects, or redirects the request. The role of the UAS lasts only for the duration of that transaction. If a process responds to a request, it acts as a UAS for that transaction. If it initiates a request later, it assumes the role of a **user agent client (UAC)** for that transaction.

UTF-8: A byte-oriented standard for encoding Unicode characters, defined in the Unicode standard. Unless specified otherwise, this term refers to the UTF-8 encoding form specified in [\[UNICODE5.0.0/2007\]](#) section 3.9.

X.509: An ITU-T standard for public key infrastructure subsequently adapted by the IETF, as specified in [\[RFC3280\]](#).

MAY, SHOULD, MUST, SHOULD NOT, MUST NOT: These terms (in all caps) are used as defined in [\[RFC2119\]](#). All statements of optional behavior use either MAY, SHOULD, or SHOULD NOT.

1.2 References

Links to a document in the Microsoft Open Specifications library point to the correct section in the most recently published version of the referenced document. However, because individual documents in the library are not updated at the same time, the section numbers in the documents may not match. You can confirm the correct section numbering by checking the [Errata](#).

1.2.1 Normative References

We conduct frequent surveys of the normative references to assure their continued availability. If you have any issue with finding a normative reference, please contact dochelp@microsoft.com. We will assist you in finding the relevant information.

[MS-CONFAV] Microsoft Corporation, "[Centralized Conference Control Protocol: Audio-Video Extensions](#)".

[MS-CONFPRO] Microsoft Corporation, "[Centralized Conference Control Protocol: Provisioning](#)".

[MS-CONMGMT] Microsoft Corporation, "[Connection Management Protocol](#)".

- [MS-OCER] Microsoft Corporation, "[Client Error Reporting Protocol](#)".
- [MS-PSOM] Microsoft Corporation, "[PSOM Shared Object Messaging Protocol](#)".
- [MS-SIPAE] Microsoft Corporation, "[Session Initiation Protocol \(SIP\) Authentication Extensions](#)".
- [MS-SIPRE] Microsoft Corporation, "[Session Initiation Protocol \(SIP\) Routing Extensions](#)".
- [MS-SIP] Microsoft Corporation, "[Session Initiation Protocol Extensions](#)".
- [RFC2119] Bradner, S., "Key words for use in RFCs to Indicate Requirement Levels", BCP 14, RFC 2119, March 1997, <http://www.rfc-editor.org/rfc/rfc2119.txt>
- [RFC2976] Donovan, S., "The SIP INFO Method", RFC 2976, October 2000, <http://www.rfc-editor.org/rfc/rfc2976.txt>
- [RFC3261] Rosenberg, J., Schulzrinne, H., Camarillo, G., Johnston, A., Peterson, J., Sparks, R., Handley, M., and Schooler, E., "SIP: Session Initiation Protocol", RFC 3261, June 2002, <http://www.ietf.org/rfc/rfc3261.txt>
- [RFC3265] Roach, A. B., "Session Initiation Protocol (SIP)-Specific Event Notification", RFC 3265, June 2002, <http://www.ietf.org/rfc/rfc3265.txt>
- [RFC3280] Housley, R., Polk, W., Ford, W., and Solo, D., "Internet X.509 Public Key Infrastructure Certificate and Certificate Revocation List (CRL) Profile", RFC 3280, April 2002, <http://www.ietf.org/rfc/rfc3280.txt>
- [RFC3311] Rosenberg, J., "The Session Initiation Protocol (SIP) UPDATE Method", RFC 3311, September 2002, <http://www.rfc-editor.org/rfc/rfc3311.txt>
- [RFC3629] Yergeau, F., "UTF-8, A Transformation Format of ISO 10646", STD 63, RFC 3629, November 2003, <http://www.ietf.org/rfc/rfc3629.txt>
- [RFC4028] Donovan, S., and Rosenberg, J., "Session Timers in the Session Initiation Protocol (SIP)", RFC 4028, April 2005, <http://www.rfc-editor.org/rfc/rfc4028.txt>
- [RFC4353] Rosenberg, J., "A Framework for Conferencing with the Session Initiation Protocol (SIP)", RFC 4353, February 2006, <http://www.rfc-editor.org/rfc/rfc4353.txt>
- [RFC4575] Rosenberg, J., Schulzrinne, H., and Levin, O., "A Session Initiation Protocol (SIP) Event Package for Conference State", RFC 4575, August 2006, <http://www.rfc-editor.org/rfc/rfc4575.txt>
- [XML10] World Wide Web Consortium, "Extensible Markup Language (XML) 1.0 (Third Edition)", February 2004, <http://www.w3.org/TR/2004/REC-xml-20040204/>

1.2.2 Informative References

- [IETF DRAFT-SIP SOAP-00] Deason, N., "SIP and SOAP", draft-deason-sip-soap-00, June 30 2000, <http://www.softarmor.com/wgdb/docs/draft-deason-sip-soap-00.txt>
- [MS-SIPREGE] Microsoft Corporation, "[Session Initiation Protocol \(SIP\) Registration Extensions](#)".
- [RFC3264] Rosenberg, J., and Schulzrinne, H., "An Offer/Answer Model with the Session Description Protocol (SDP)", RFC 3264, June 2002, <http://www.rfc-editor.org/rfc/rfc3264.txt>
- [RFC3325] Jennings, C., Peterson, J., and Watson, M., "Private Extensions to the Session Initiation Protocol (SIP) for Asserted Identity within Trusted Networks", RFC 3325, November 2002, <http://www.rfc-editor.org/rfc/rfc3325.txt>

1.3 Overview

1.3.1 Architecture and Background

The conferencing system defined in this document extends the tightly coupled **conference** architecture described in [\[RFC4353\]](#) by incorporating the following:

- Support for multiple occurrences of a **Multipoint Control Unit (MCU)**, as opposed to plain **mixers**, to participate in a conference and provide richer control and media conferencing services. MCUs maintain and publish conference state to the **focus** using the conference data model described in [\[RFC4575\]](#).
- A conference-provisioning component called the **Focus Factory**, which is used to create, delete, modify, and query conference information. Conference provisioning is described in [\[MS-CONFPRO\]](#).
- Implementation of the conference policy and **notification** services described in [\[RFC4353\]](#) and performance of various runtime conference management tasks, such as conference activation and deactivation, allocating and managing MCUs, and performing conference roster aggregation. The focus notification service implements the conference **event package** notifications described in [\[RFC4575\]](#).

Conference state is the current participant roster and status and configuration of all individual conference components in the collection of components in a conference. Conference state is encapsulated by a full conference state event package, as defined in section [2.2.2.2](#).

Simple Join is made possible by the Join Manager. The Join Manager is responsible for parsing the conferencing join web **Uniform Resource Locator (URL)** and determining the **conference URI (conference-URI)** that is required by the client to join the conference. Join Manager is also responsible for detecting the presence of the client and starting it.

This architecture and the inter-component protocols are shown in the following figure. Note that this is just one possible way of implementing a conferencing system. It is used to illustrate the protocol for readability purposes. Implementers can adopt other architectures, as long as they keep the external protocol consistent with this specification.

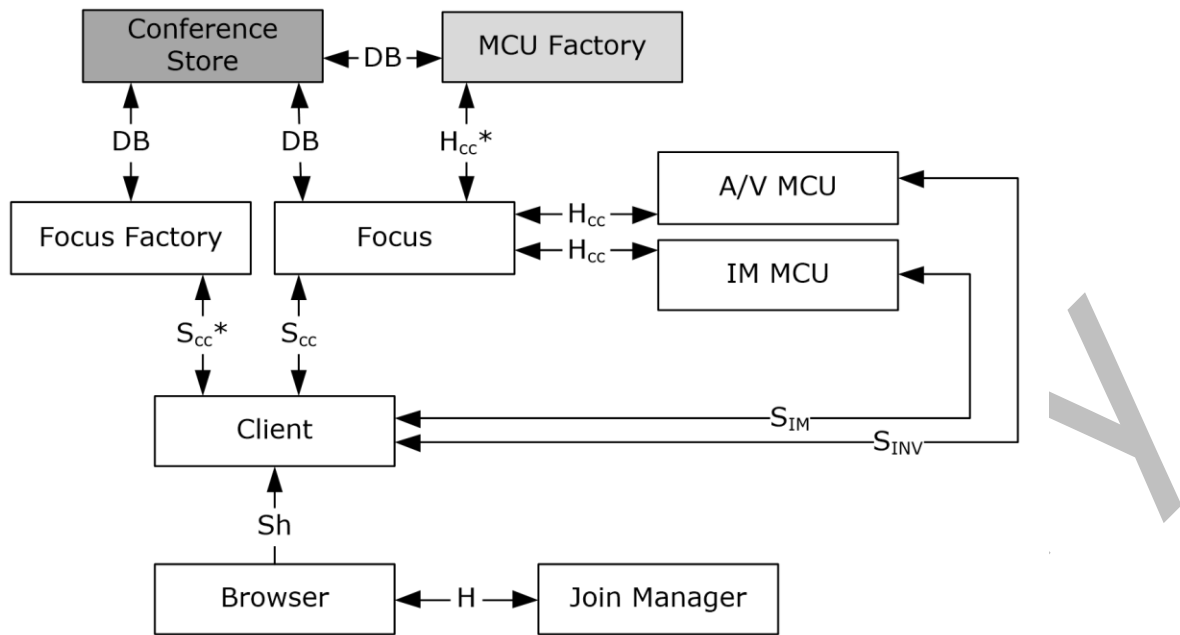

LEGEND

| | |
|-------------------|--|
| H | HTTP |
| Sh | Shell execute |
| S _{cc} | C3P over SIP (INVITE dialog + C3P in INFO) + conference event package |
| S _{cc} * | C3P over SIP (no dialog + C3P in SERVICE) + <u>no conference event package</u> |
| H _{cc} | C3P over HTTP + conference event package over HTTP |
| H _{cc} * | C3P over HTTP + <u>no conference event package</u> |
| S _{IM} | SIMPLE-based IM (INVITE dialog + session-based IM with MESSAGE) |
| S _{INV} | SIP SDP RT A/V media negotiation (INVITE dialog) |
| DB | Interface to Conference Store (for example, SQL) |

Figure 1: Conferencing architecture

In the preceding figure, the client uses the Focus Factory to schedule a conference. During conference creation, the client supplies the conference metadata and the modalities of interest. Each modality in turn is comprised of several media types, such as meeting, audio, video, and chat. The conference-URI and other metadata for the created conference are returned by the Focus Factory to the client. This architecture assumes a common shared **conference store** between the Focus Factory and the focus.

The client then joins a conference by communicating with the focus. At conference startup, the focus retrieves the conference metadata from the conference store and then bootstraps all of the MCUs needed for the conference. It then admits the participant into the conference and notifies all watchers of conference state changes. The client can then perform various conference control operations through the focus.

After an MCU is bootstrapped, it publishes its initial state and capabilities through the conference roster. Participants discover the MCUs through the conference roster and can then join the MCUs of interest by sending the appropriate command to the focus. After a participant joins the MCU, it can exchange media with the MCU, as well as perform appropriate media control. Unlike mixers, described in [RFC4353], MCUs in the conferencing system defined by this specification are capable of receiving **conference control commands** from the focus and performing changes to the conference state. Each MCU maintains its conference state, and publishes it to the focus through the general conference notification mechanism described in [RFC4575].

The focus aggregates the conference state received from the MCUs with the conference state that it maintains into a single conference document and publishes it to its watchers. This is an extension to the specifications in both [RFC4575] and [RFC4353].

Note that the client entity can be one or more clients. In addition to the **organizer** of the conference, whose joining sequence is described earlier, other users who request to participate in the conference can do so via Simple Join. When the user clicks on the conferencing join web URL, Join Manager receives the request. Upon receipt of the request, Join Manager parses the conferencing join web URL and returns a script in a **Hypertext Transfer Protocol (HTTP)** response that contains logic and contents of an XML document embedded with the conference-URI. The logic in the script is to enumerate the candidate applications installed on the client computer, create the XML document in the appropriate location with an appropriate extension, and pick one of the client applications to be bootstrapped with the conference document to join the meeting.

1.3.2 End-to-End Call Flow Overview

This section describes a basic end-to-end call flow of the signaling steps involved in establishing a **conference**.

The following figure shows a typical call flow for establishing a conference.

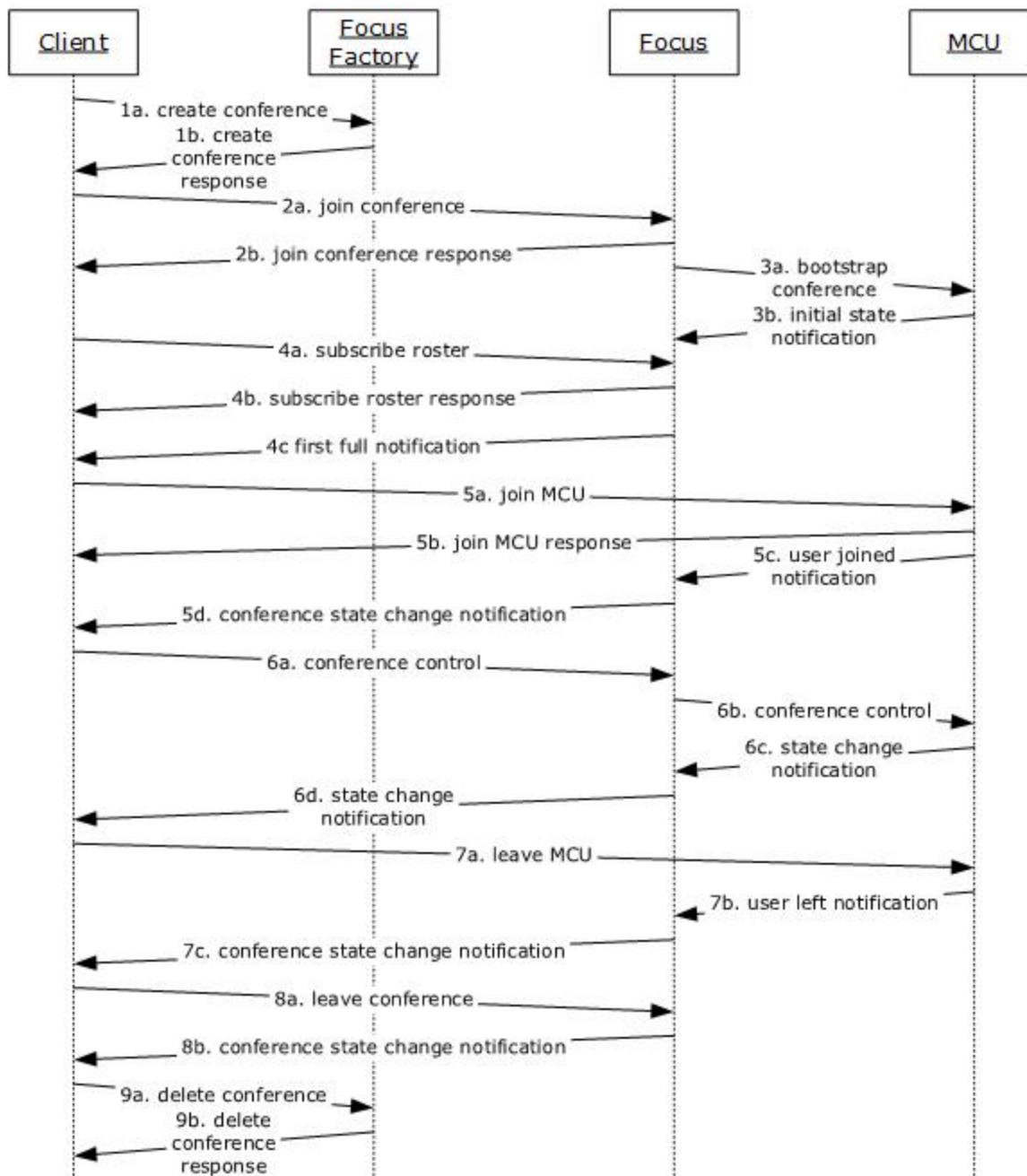

Figure 2: Conference signaling call flow

The call flow in the preceding figure is explained in this section. It is useful to note the following:

- The client entity can be one or more clients participating in a conference, including the **organizer** of the conference.
- The **Focus Factory** and the **focus** can be collocated. They are shown as distinct entities for readability.
- The **MCU** entity can be one or more MCUs servicing the conference. The focus and the MCU can be collocated. They are shown as distinct entities for readability.

Unless otherwise specified, the following steps are temporally correlated.

Step 1: The organizer contacts the Focus Factory to provision a new conference. The provisioning protocol is described in [MS-CONFPRO]. The client obtains its Focus Factory **Uniform Resource Identifier (URI)** using **in-band provisioning**, as described in [MS-SIPREGE]. At the end of this step, the client has a **conference-URI** and associated provisioning data, such as the conference subject and conference expiration time.

Step 2: The client joins the conference by sending a signaling request to the focus. At the end of this step, the client gets a response from the focus that it has joined this conference.

Step 3: A conference is activated in the focus when the first client joins the conference. As part of this process, the focus bootstraps the MCUs needed for the conference. On successful bootstrap, the MCUs notify the focus of the initial conference state. Note that step 3 does not have temporal correlation with step 2, but is a prerequisite for step 4.

Step 4: The client subscribes to the conference roster, after which it can receive all the conference state change notifications. At the end of this step, the client receives the first full conference state document, with which it can construct an initial conference state.

Step 5: The client joins one or more MCUs available in the conference. This step involves signaling and media handshakes that are MCU-specific. This signaling step involves sending a **Session Initiation Protocol (SIP) INVITE** to the MCU and then negotiating media. At the end of this step, the MCU notifies the focus that the user has joined the MCU, which in turn is propagated to all watchers.

Step 6: The client performs various conference control operations. Examples of conference control include locking a conference, ejecting users, promoting users, and muting a user's media. Conference control can span multiple components, such as MCUs and the focus. This step can also result in state change **notifications**, which are sent to all watchers.

Step 7: The conference ends and the client leaves the MCU by performing an appropriate MCU-specific signaling handshake. The MCU notifies the focus that the user has left and this, in turn, is propagated to all watchers. At this point, the client could still be part of the conference, but is not participating in the media types represented by the MCU.

Step 8: The client leaves the conference completely by sending a signaling request to the focus. At this point, the client is no longer part of the conference.

Step 9: The organizer sends a request to the Focus Factory to de-provision the conference.

1.3.3 Inter-Component Protocols

The protocols used between the client and the server components are given in the following subsections.

1.3.3.1 Browser to Join Manager

To enable Simple Join, the Join Manager returns a JavaScript script in a **Hypertext Transfer Protocol (HTTP)** response that will detect the presence of the client. The script runs at the client end in the browser and detects and selects the appropriate client to launch.

This script makes use of the protocol handler detection APIs provided for this purpose. Using these APIs, the appropriate client is launched. The client then makes a separate web request to the Join Manager to get the required data to join the meeting.

When such APIs are not available, the script will perform the detection and launch the client with the help of an **ActiveX control** or a Firefox plug-in. The ActiveX control or Firefox plug-in creates a

document with a pre-defined schema that is provided by the script, and the shell executes the document to launch the appropriate client.

1.3.3.2 Client to Focus Factory

The client uses the application/cccp+xml document format to exchange **conference** provisioning commands with the **Focus Factory**. The **Session Initiation Protocol (SIP) SERVICE** method is used as the carrier protocol for these documents, as described in [\[IETF DRAFT-SIPSOAP-00\]](#).

1.3.3.3 Client to Focus

The client extends the procedures described in [\[RFC4353\]](#) to communicate with the **focus**. Specifically, it establishes an **INVITE dialog** with the focus and then uses the application/cccp+xml document format to exchange **conference control commands** with the focus. The **Session Initiation Protocol (SIP) INFO** method is used as the carrier protocol for these documents.

The client establishes a **SUBSCRIBE** dialog with the focus and then uses the conference **event package** to receive conference notifications, as described in [\[RFC4575\]](#).

1.3.4 Scope of this document

This specification defines extensions to the conference **event package** data model described in [\[RFC4575\]](#) to support the architecture described earlier. These documents are also referred to as application/conference-info+xml documents.

This specification defines the Centralized Conference Control Protocol (C3P), which can be used to exchange **conference control commands** between various conferencing entities. These are also referred to as application/cccp+xml documents.

This specification also defines the mechanism for using **Session Initiation Protocol (SIP)** as the carrier protocol for C3P commands between clients and the **focus**.

Additionally, this specification defines the roster aggregation algorithm used by the focus to aggregate the conference state published by multiple **MCUs** in the conference.

This specification treats the focus and the MCUs as one homogeneous "server" entity as it is presented to the client. The protocol used between the focus and the MCUs to exchange messages, if they are not collocated, is outside the scope of this specification. However, there are some inter-component protocol behaviors that all implementations are required to adhere to so that a holistic behavior can be presented to the client. These behaviors are specified in this document.

Extensions to this specification can specify the protocol used between the client and the MCUs for negotiating media sessions.

1.4 Relationship to Other Protocols

This protocol depends on the **Session Initiation Protocol (SIP)**. It defines additional SIP message body formats and XML schemas to support the protocols defined in this document. This protocol also depends on the **conference event package** data model described in [\[RFC4575\]](#) and defines extensions to it.

1.5 Prerequisites/Preconditions

This protocol assumes that both the clients and the server support **SIP**, and that they implement the extensions specified in the following extension specifications, as needed:

- Session Initiation Protocol Extensions [\[MS-SIP\]](#)

- Session Initiation Protocol Routing Extensions [\[MS-SIPRE\]](#)

This protocol assumes that conferences are provisioned using the protocol described in [\[MS-CONFPRO\]](#).

1.6 Applicability Statement

This protocol is applicable when clients and the server support **SIP** and intend to use one or more features of the conferencing functionality defined by this protocol.

1.7 Versioning and Capability Negotiation

This protocol uses the **C3PVersion** attribute to indicate the version of the Centralized Conference Control Protocol messages. The currently defined protocol version is "1".

Explicit capability negotiation can be done for these messages using standard SIP-based mechanisms, such as the **SIP Supported** header.

1.8 Vendor-Extensible Fields

None.

1.9 Standards Assignments

None.

2 Messages

2.1 Transport

This protocol supports **Internet Protocol version 4 (IPv4)/Internet Protocol version 6 (IPv6)**<1>.

2.1.1 HTTP Transport

Simple Join uses **HTTP** and **HTTPS** transport.

2.1.2 SIP Transport

This specification does not introduce a new transport to exchange messages but is capable of being used with **Transmission Control Protocol (TCP)** and **Transport Layer Security (TLS)** as transports for **SIP**.

2.2 Message Syntax

This conferencing specification does not introduce a new message format for **SIP**. It relies on the **SIP message** format specified in [\[RFC3261\]](#) section 7, the authentication extensions defined in [\[MS-SIPAE\]](#), the routing protocol extensions defined in [\[MS-SIPRE\]](#), and the connection management protocol defined in [\[MS-CONMGMT\]](#).

Conferencing messages defined by this specification can be categorized as follows:

- Signaling messages exchanged between the client and the **focus** for **conference signaling dialog** establishment or teardown.
- Subscription messages exchanged between the client and the focus for conference **subscription** dialog establishment or teardown.
- Notification messages from the focus to the client containing C3P request and response documents.
- Messages exchanged between the focus and the client that update the conference roster.
- Control messages exchanged between the client and the focus or **MCUs**, or both, for the purposes of conference control.
- HTTP messages exchanged between the focus and the client that enable the client to communicate with the Join Manager.

These message formats are discussed in subsequent sections.

2.2.1 Focus Signaling Messages

2.2.1.1 Common Signaling Header Formats

The following common header formats and rules are applicable to all of the messages defined in this section.

The requests and responses SHOULD contain authentication headers, as defined in [\[MS-SIPAE\]](#).

The **Content-Type header** field MUST be set to "application/cccp+xml".

The content body MUST conform to the request or response format defined in section [2.2.2.12](#).

The **ms-keep-alive** header is optional. If specified, follow the specifications in [\[MS-CONMGMT\]](#).

Unless specified otherwise in the following sections, all unknown headers SHOULD be ignored by the processing entities.

2.2.1.2 Signaling Dialog Establishment Message

The **INVITE** request is used by a participant to establish a **dialog** with the **focus**. It relies on the **SIP message** formats specified in [\[RFC3261\]](#) section 7.1. The sender is a **user agent client (UAC)**, as defined in [\[RFC3261\]](#) section 6.

The **SIP Uniform Resource Identifier (URI)** in the **To** header field of the request MUST be set to the **conference-URI**.

The client MUST add a valid **Contact** header that can be used as the remote target URI of the SIP dialog route set, as specified in [\[RFC3261\]](#) section 12.

A **Supported** header field with the option tag **timer** is optional in INVITE requests and, if specified, follows the specifications in [\[RFC4028\]](#) section 7.1. The **Session-Expires** header field SHOULD be present in requests.

The body of the request MUST be set to either a C3P **addUser** Request Body for a focus INVITE request, as specified in section [2.2.3.3](#), or a C3P **endorseUser** Request Body for a focus INVITE request, as specified in section [2.2.3.5](#). [<2>](#)

The body of the response MUST be set to either a C3P **addUser** Response Body for a focus INVITE response, as specified in section [2.2.3.4](#), or a C3P **endorseUser** Response Body for a focus INVITE response, as specified in section [2.2.3.6](#). [<3>](#)

The **200 OK** response to INVITE requests MUST have a valid **Contact** header that can be used as the remote target URI of the SIP dialog route set, as specified in [\[RFC3261\]](#) section 12. It SHOULD have the **isfocus** feature parameter, as described in [\[RFC4579\]](#) section 4.

The INVITE response MUST contain an **Allow** header that lists the SIP verbs supported by the focus. This list consists of INVITE, ACK, BYE, CANCEL, UPDATE, and INFO.

Require headers can be present in the request.

2.2.1.3 Signaling Dialog Update Message

The UPDATE request is used to extend a **dialog**. This request relies on the **SIP UPDATE** message format defined in [\[RFC3311\]](#) section 5.1.

The message body MUST be empty for both requests and responses.

The **Supported** header field with the option tag **timer** MUST be present in the request.

Require headers MAY be present in the request.

2.2.1.4 Signaling Dialog Teardown Message

The BYE request is used to tear down a **dialog**. This request relies on the **SIP message** formats specified in [\[RFC3261\]](#) section 7.1. The sender is a **UAC**, as defined in [\[RFC3261\]](#) section 6.

The BYE response is used to respond to a BYE request. It relies on the SIP message formats specified in [\[RFC3261\]](#) section 7.2.

The message body SHOULD be empty for both requests and responses.

Require headers MAY be present in the request.

2.2.1.5 Conference Control Messages

INFO **SIP requests** and responses are used to exchange conference control messages. These messages rely on the **SIP message** formats specified in [\[RFC2976\]](#) section 2. Unless otherwise specified, these INFO messages are exchanged within the **INVITE dialog** specified previously.

The INFO request MUST contain a valid request message body as defined in section [2.2.2.12](#).

A body MUST be present for INFO responses. If a body is present, it MUST be a valid response body, as defined in section 2.2.2.12.

Require headers MAY be present in the INFO request or response.

2.2.2 Focus Subscription Messages

The **focus subscription dialog** SHOULD follow the conference **event package** dialog establishment procedures described in [\[RFC4575\]](#) section 3.

2.2.2.1 Subscription Establishment Messages

Subscription establishment SHOULD use the **SUBSCRIBE** request and response defined in [\[RFC3265\]](#) section 3.1.4 with the conference **event package** defined in [\[RFC4575\]](#) section 3.

The **SIP URI** in the **To** header field of the request MUST be set to the **conference-URI**.

The client MUST add a valid **Contact** header that can be used as the remote target URI of a SIP **dialog** route set, as specified in [\[RFC3261\]](#) section 12.

The following extensions are specified for SUBSCRIBE requests:

- The **Accept** header, if present, SHOULD be populated with a value of "application/conference-info+xml". Another **Accept** header SHOULD NOT be present.
- The **Supported** header field with the option tag **ms-benotify** can be present. If present, it SHOULD follow the **Best Effort NOTIFY (BENOTIFY)** extensions defined in [\[MS-SIP\]](#).
- The **Supported** header field with the option tag **ms-piggyback-first-notify** SHOULD be present. If present, it SHOULD follow the piggyback **notification** mechanism defined in [\[MS-SIP\]](#).
- **Require** headers MAY be present in the request.
- The **ms-telemetry-id** header SHOULD ≤ 4 be present in the request and provides the server with an identifier to report telemetry data against the established conference subscription dialog. The recommended format for this header is the same as that for the **telemetry-id** attribute defined in section [2.2.3.1.2](#).

2.2.2.2 Extensions to the application/conference-info+xml Document Format

The application/conference-info+xml document format, as specified in [\[RFC4575\]](#) section 5, specifies the data model for a **conference**. This specification extends the conference data model with additional elements.

All of the extension elements that are used in messages defined by this specification are defined subsequently. Extensions to this document can define the semantics of other elements and attributes on which they depend. They can also introduce new extensions to this data model.

The cardinality of each extension element is specified in the XML schema using standard **minOccurs** and **maxOccurs** XSD conventions. Similarly, the cardinality of each extension attribute is specified in the XML schema using standard "required" or "optional" attribute values. Similarly, the namespace of each extension attribute or element is specified in the XML schema using standard conventions and is omitted here for brevity. The **conference-description** element is defined in the XML schema in section [6.3.1](#).

Requests and responses can further restrict this data model. Any such restrictions are specified by their message syntaxes as needed.

The following is the data model hierarchy for a conference. Elements in the data model are identified by the following markings:

- Extensions added by this protocol are marked with a plus sign (+).
- Elements marked with an asterisk (*) SHOULD NOT be used in conferencing commands or **notifications** because they are not used by the conferencing system.
- Elements marked with a hyphen (-) have additional semantics beyond those defined in [RFC4575] section 5.
- Elements marked with a bang (!) SHOULD NOT be used in conferencing commands. The Conferencing Server will fail the request if the element is specified.

```
|
|-- conference-description
|  |--display-text (*)
|  |--subject
|  |--free-text (*)
|  |--keywords (*)
|  |--conf-uris (-)
|  |--service-uris (*)
|  |--maximum-user-count (*)
|  |--available-media (*)
|  |--disclaimer (+)
|  |--organizer (!)
|  |--conference-id (+)
|  |--conference-key (+)
|  |--last-update (+)
|  |--last-activate (+)
|  |--is-active (+)
|  |--expiry-time (+)
|  |--admission-policy (+)
|  |--organizer-roaming-data (+)
|  |--notification-data (+)
|  |--pstn-access (+)
|  |--lobby-capable (+)
|  |--anonymous-type-allowed (+)
|  |--join-url (+)
|  |--autopromote (+)
|  |--autopromote-allowed (+)
|  |--pstn-lobby-bypass (+)
|  |--pstn-lobby-bypass-allowed (+)
|  |--disclaimer-title (+)
|  |--recording-allowed (+)
|  |--externaluser-recording-allowed (+)
|  |--server-mode (+)
|  |--recording-notification (+)
|  |--custom-invite (+)
|  |--anonymous-dialout-allowed (+)
|  |--endorse-allowed (+)
```

```

| |-main-video-mute-allowed (+)
| |-pano-video-mute-allowed (+)
| |-is-large-meeting (+)
| |-in-room-user-notification-supported (+)
| |-nonenterprise-user-dialout-allowed (+)
|
|-- host-info (*)
|
|-- conference-state (*)
|
|-- users
|   |-- user
|     |--display-text
|     |--associated-aors (*)
|     |--roles (-)
|     |--languages (*)
|     |--cascaded-focus (*)
|     |-- endpoint
|       |--display-text (*)
|       |--referred (*)
|       |--status
|       |--joining-method
|       |--joining-info
|       |--disconnection-method (*)
|       |--disconnection-info (*)
|       |--media
|         |--display-text
|         |--type
|         |--label
|         |--src-id
|         |--status
|         |--media-ingress-filter (+)
|         |--media-egress-filter (+)
|
|       |--call-info
|       |--roles (+)
|       |--authMethod (+)
|       |--accessMethod (+)
|       |--clientInfo (+)
|       |--post-dial (+)
|       |--pstnRole (+)
|       |--pstnLeaderPassCode (+)
|       |--endpoint-capabilities (+)
|       |--is-robot (+)
|       |--current-sidebar (+)
|       |--session-on-behalf-of (+)
|       |--client-recording (+)
|       |--endpoint-notification (+)
|         |--in-room-users (+)
|           |--state (+)
|           |--user (+)
|             |--display-text (+)
|             |--auth-method (+)
|             |--entity (+)
|             |--state (+)
|
|-- sidebars-by-ref (*)
|
|-- sidebars-by-val (*)
|
|-- conference-view (+)
|   |-- entity-view (+)
|     |-- entity-capabilities (+)
|     |-- entity-policy (+)
|     |-- entity-settings (+)
|     |-- entity-state (+)

```

2.2.2.3 conference-description Extensions

The following elements are extensions to the conference-description element.

disclaimer: A descriptive string that can be used as a general-purpose disclaimer in the conference notification document.

organizer: Specifies the **SIP** address and display name of the organizer of the **conference**.

conference-key: A case-sensitive alpha-numeric string that MAY be presented by anonymous users. The semantics of this element are specified in [\[MS-CONFPRO\]](#) section 2.2.1.2.

last-update: Specifies the date and time when the conference was created or last modified. The semantics of this element are specified in [\[MS-CONFPRO\]](#) section 2.2.1.2.

last-activate: Specifies the date and time when the conference was last activated. The semantics of this element are specified in [\[MS-CONFPRO\]](#) section 2.2.1.2.

is-active: Specifies whether the conference is active at the time this value is set. The semantics of this element are specified in [\[MS-CONFPRO\]](#) section 2.2.1.2.

expiry-time: Specifies the date and time in UTC after which the conference can be deleted. The semantics of this element are specified in [\[MS-CONFPRO\]](#) section 2.2.1.2.

disclaimer-title<5>: A string that can be used as a title for a general-purpose disclaimer in the conference **notification** document.

lobby-capable<6>: Specifies whether the conference supports changing the admission policy after activation by issuing a **modifyConferenceLock** command, as defined in section [3.6](#). The value of this MUST be "true".

anonymous-type-allowed<7>: Specifies whether the conference supports the anonymous admission policy. Note that if a conference supports changing the admission policy after activation, it might not support the anonymous admission policy.

join-url: Specifies an **HTTP** or **HTTPS** URL that can be used for joining the conference.

autopromote<8>: The current automatic promotion policy applied to the conference that identifies who will be promoted to presenter upon being admitted to the conference. The value for this element is defined by an unsigned integer, as defined in [\[MS-CONFPRO\]](#) section 2.2.1.2. Each bit represents a class of users that are automatically promoted. The currently defined values are as follows. The **autopromote** value could be set to the combination of the following values:

- "None": 0x00000000 (as default)
- "Everyone": 0x80000000 (bit 31)
- "Company" (Authenticated users): 0x00008000 (bit 15)

New values might be added in future releases.

autopromote-allowed<9>: The allowed automatic promotion policies that could be applied to the conference by a presenter through issuing a **modifyConferenceLock** command, as defined in section [3.6](#). The value of this element is defined the same as the **autopromote** element.

admission-policy: The conference admission policy. Three admission policies are defined by this protocol, as follows:

- **closedAuthenticated:** Admission to the conference is restricted to the invitees specified by this **organizer**. Invitee list creation and modification is specified in [\[MS-CONFPRO\]](#).

- **openAuthenticated**: Admission to the conference is permitted for any authenticated user. Authentication mechanisms are specified in [\[MS-SIPAE\]](#). This is the default admission policy. Users authenticated through federation are classified as not authenticated in this context.
- **anonymous**: Admission to the conference is permitted for any user.

organizer-roaming-data: The semantics of this element are specified in [\[MS-CONFPRO\]](#) section 2.2.1.2.

notification-data: Conference level notification data that can be specified by the organizer. This is made available to all participants through conference notification. The semantics of this attribute are further defined in [\[MS-CONFPRO\]](#).

pstn-access: The **public switched telephone network (PSTN)** access information for the conference.

pstn-lobby-bypass[<10>](#): Specifies whether PSTN users can bypass the conference lobby.

pstn-lobby-bypass-allowed[<11>](#): Specifies whether the conference could be modified to allow users joining the conference through the PSTN to bypass the conference lobby. A presenter can change the current lobby bypass setting by issuing a **modifyConferenceLock** command, as defined in section 3.6.

recording-allowed[<12>](#): Specifies whether internal clients can record the conference. This is set by the administrator.

externaluser-recording-allowed[<13>](#): Specifies whether external clients can record the conference. This is set by the administrator. This element is applicable only when the **recording-allowed** element is "TRUE".

server-mode[<14>](#): Specifies the conference compatible mode. The supported value is "14". The conference does support a lobby experience. When the conference is locked, all participants except the organizer will be put in an on-hold state, and the participants that are on-hold will wait to be admitted to the conference.

recording-notification: Specifies whether the server that this conference is hosted on identifies endpoints that are recording the conference, in the roster document of the conference.

custom-invite: Specifies meeting invite customization information applicable to the organizer of the conference. This element MAY contain the following child elements:

- **logo-url**: An HTTP link to a location where clients can get a logo to render for a customized meeting invite to the organizer's conference.
- **legal-url**: An HTTP link that clients can render for legal information for a customized meeting invite to the organizer's conference.
- **help-url**: An HTTP link that clients can render for help information for a customized meeting invite to the organizer's conference.
- **settings-url**: An HTTP link that clients can render for a user settings page for a customized meeting invite to the organizer's conference.
- **custom-footer-text**: A string value that clients can use to render a custom footer for a customized meeting invite to the organizer's conference.

anonymous-dialout-allowed: Specifies whether the meeting organizer's conferencing policy allows anonymous participants who have joined the conference to add PSTN numbers to the conference using a dial-out add user request as defined in section [2.2.3.15](#).

endorse-allowed: Specifies whether the server hosting the conference allows the use of the **endorseUser** command defined in section [2.2.3.5](#).

main-video-mute-allowed: Specifies whether the server hosting the conference allows scheduling conferences that specify hard mute of the main video, defined in [\[MS-CONFAV\]](#) section 6.2.

pano-video-mute-allowed: Specifies whether the server hosting the conference allows scheduling conferences that specify hard mute of the pano video, defined in [\[MS-CONFAV\]](#) section 6.2.

is-large-meeting: Specifies whether the conference will run with large meetings optimizations, defined in [\[MS-CONFAV\]](#) section 6.2.

nonenterprise-user-dialout-allowed: Specifies whether the meeting organizer's conferencing policy allows non enterprise who have joined the conference to add **PSTN** numbers to the conference using a dial-out add user request as defined in section [2.2.3.15](#)

2.2.2.4 Extensions to conf-uris Element Semantics

Implementations conforming to this protocol MUST generate and consume the **conf-uris** element based on the following extension semantics, in addition to those defined in [\[RFC4575\]](#) section 5.3.1:

- An **entry** element MUST be listed for each **MCU** in the **conference**.
- An **entry** element MUST be listed for each alternative conference join **URLs**.
- This specification specifies the following for the **purpose** subelement:
 - **audio-video:** An Audio-Video MCU.
 - **chat:** An Instant Messaging MCU.
 - **meeting:** A legacy Web Conferencing/Application Sharing MCU.
 - **data-conf:** A Web Conferencing MCU implementing the protocols specified in [\[MS-PSOM\]<15>](#).
 - **phone-conf:** A Phone Conferencing MCU.
 - **applicationsharing:** An Application Sharing MCU [<16>](#).
 - **web-internal:** A URL to join the conference via a web browser interface from inside the enterprise [<17>](#).
 - **web-external:** A URL to join the conference via a web browser interface from outside the enterprise [<18>](#).
- The **uri** subelement lists a **SIP URI** corresponding to an **audio-video, chat, meeting, data-conf, phone-conf, applicationsharing purpose** element.
- The **encrypted-uri** subelement lists the encrypted URL corresponding to the **web-internal** or **web-external purpose** element [<19>](#).

Extensions to this document can specify one or more signaling protocols to enable clients to join and access these MCUs.

2.2.2.5 Extensions to roles Element Semantics

The cardinality of the **roles** element is constrained to zero or one by this specification. Thus, entities MUST NOT list more than one **role** inside the **roles** element when used as a sub-element of the **user** element or the **endpoint** element.

2.2.2.6 endpoint Element Extensions

The **endpoint** extensions are used to communicate various **focus** and MCU-specific extension data for each connected **endpoint**.

The following attributes are defined for each **endpoint** element:

- **session-type**: The entity to which the **endpoint** is connected. This attribute MUST be set to the **MCU-Type** if the **endpoint** is connected to an **MCU**. If the **endpoint** is connected to the focus itself, it MUST be set to "focus".
- **epid**: This attribute is an **endpoint identifier (EPID)**, if available, as defined in [\[MS-SIPRE\]](#).
- **sip-instance**: This attribute is an endpoint **SIP** instance identifier, if available, as SIP.INSTANCE endpoint defined in [\[MS-SIPRE\]](#) section [3.3.3.1](#).
- **endpoint-uri**: A **URI** that can be used to target messages to the **endpoint**, if applicable. For example, this attribute can be a **Globally Routable User Agent URI (GRUU)** identifying the **endpoint**.
- **refer-to-uri**: A URI that can be used as the **request-URI** of any outgoing requests generated by the receiver when processing a C3P request. This attribute MUST be a SIP URI, and MAY include any SIP headers. Any SIP headers in the **refer-to-uri** attribute SHOULD be propagated to the outgoing request, suitably encoded, as specified in [\[RFC3261\]](#) section 19.1.5.
- **asserted-identity**: The asserted identity URI of an **endpoint**, as defined in [\[RFC3325\]](#) section 3. This attribute MUST be a SIP URI.

The following child elements are defined for each **endpoint** element:

- **roles**: The roles for the **endpoint**, as defined in [\[RFC4575\]](#) section 5.6.3. This element is optional.
- **authMethod**: Whether the user is an enterprise user with a value of "enterprise", an anonymous user with a value of "anonymous", or a federated user with a value of "federated", as determined by the focus or the MCU. This element is optional.
- **accessMethod**: Whether the user is connected from within the enterprise with a value of "internal" or from the public Internet through the enterprise edge with a value "external". This element is optional.
- **clientInfo**: Various client-specific information. Extensions to this specification can define additional elements and attributes within the **clientInfo** extension and their processing semantics.
- **endpoint-capabilities**: The capabilities supported by this **endpoint**. Extensions to this specification can define the subelements and attributes within this extension and their processing semantics.
- **is-robot**: An element that specifies a robot.
- **separator**: An element indicating a new extension start. All elements after one separator are in the same extension group.
- **session-on-behalf-of**: An element containing the URI on behalf of whom the user is joining the **conference**<20>. This element MUST be put after the first **separator** if it is specified.
- **client-recording**: An element to specify if the **endpoint** is in recording status. This element MUST be put after the second **separator** if it is specified.
- **endpoint-notification**: An element that is a container for the **in-room-users** element.

The **in-room-users** element is a container of **user** elements, each describing a user that is sharing the current endpoint representing that the user is in the same room. The **in-room-users** element also contains a **state** element which indicates the in-room user list contains the entire list of users with the value "full".

The following child elements are defined for each **user** element:

- **display-text: display-text**, as defined in [RFC4575] section 5.6.1
- **auth-method: authMethod**, as defined above.
- **entity: entity**, as defined in [RFC4575] section 5.6
- **state: state**, as defined in [RFC4575] section 5.6

The **media-ingress-filter** element is defined in [MS-CONFAV] section 2.2.2.1.2.1 and the **media-egress-filter** element is defined in [MS-CONFAV] section 2.2.2.1.2.2. The **post-dial**, **pstnRole**, **pstnLeaderPassCode**, **current-sidebar** elements are reserved for future use.

2.2.2.7 conference-view Element Extensions

The **conference-view** extension is used to communicate settings, policies, capabilities, and state information for the **focus** and the **MCUs** within the **conference**.

The **conference-view** element is a container of **entity-view** elements, each describing either an MCU or the focus.

The following attributes are defined for the **conference-view** element:

- **state**: Indicates whether the document contains all of the **conference-view** information, with the value "full", or only the information that has changed after the previous document, with the value "partial".

The following attributes are defined for each **entity-view** element:

- **entity**: The **URI** that identifies the entity being described in the document. The focus MUST be addressed using the **conference-URI**. The MCUs MUST be addressed using the **MCU-Conference-URI**.
- **state**: Indicates whether the document contains the entire **entity-view** information, with the value "full", or only the information that has changed after the previous document, with the value "partial". The value "deleted" SHOULD be used only if the entity is removed from the conference.

The following child elements are defined for each **entity-view** element:

- **entity-capabilities**: The capabilities supported by the entity. It MUST NOT be present in **conference control requests**. It SHOULD be present in conference **notifications**.
- **entity-policy**: The policies that need to be applied by the entity for the conference. It can be present in conference control requests sent to the entity. It MUST NOT be present in conference notifications.
- **entity-settings**: The settings that need to be applied by the entity for the conference. It SHOULD be present in conference creation requests, as specified in [MS-CONFPRO] section 2.2.1.5. It can be present in conference control requests sent to the entity. It MUST NOT be present in conference notifications.
- **entity-state**: The current state of the conference within the entity. It MUST NOT be present in conference control requests sent to the entity. It MUST be present in "full" entity-view notifications. It SHOULD be present in other entity-view notifications.

- **entity-shared-data:** This element is reserved and MUST NOT be present in conference control requests. This represents shared data for MCUs and is opaque to the clients.

The following child elements are defined for each **entity-capabilities** element:

- **supported-content-type: supported-content-type**, as defined in section [2.2.2.8](#).

Other child elements of **entity-capabilities** elements can be specified in extension specifications.

Child elements of **entity-policy** and **entity-settings** elements can be specified in extension specifications.

The following child elements are defined for each **entity-state** element:

- **displayText: display-text**, as defined in [\[RFC4575\]](#) section 5.6.1.
- **userCount: user-count**, as defined in [\[RFC4575\]](#) section 5.5.1.
- **active: active**, as defined in [\[RFC4575\]](#) section 5.5.2.
- **locked: locked**, as defined in [\[RFC4575\]](#) section 5.5.3.
- **data-mcu-state: data-mcu-state**, as defined in section [2.2.2.9](#).
- **permission-options: permission-options**, as defined in section [2.2.2.10](#).
- **permissions: permissions**, as defined in section [2.2.2.11](#).

Other elements and attributes can be defined in extension specifications.

2.2.2.8 supported-content-type Element Extension

The **supported-content-type** extension is used by Web Conferencing **MCUs** within the **conference** to indicate which content types and their corresponding PSOM interfaces are supported by the MCU. Content types are identified by string names in accordance with the **Package** schema defined in [\[MS-PSOM\]](#) section [3.2.4.1.4.2](#). A Web Conferencing MCU SHOULD provide one or more of these elements. For each **supported-content-type** element, the Web Conferencing MCU MUST support at least one version of the PSOM interface corresponding, as per [\[MS-PSOM\]](#), to the content type. If at least one **supported-content-type** element is specified, the Web Conferencing MCU MUST NOT support any version of the PSOM interface corresponding, as per [\[MS-PSOM\]](#), to any unspecified content types. If no **supported-content-type** elements are specified, the Web Conferencing MCU MUST support only the PSOM interfaces corresponding, as per [\[MS-PSOM\]](#), to the following content types:

- **Content.Ppt**
- **Content.Whiteboard**
- **Content.NativeFileOnly**
- **Content.Poll**

2.2.2.9 data-mcu-state Element Extensions

The **data-mcu-state** extension is used to communicate state information for Web Conferencing **MCUs** within the **conference**. An MCU SHOULD provide these elements through C3P, and a client SHOULD use these values to avoid establishing a PSOM connection when there is no content to be displayed to the user. If these elements are not present, a client MUST NOT assume they have any particular default value. For additional details about Web Conferencing MCU-specific concepts, see [\[MS-PSOM\]](#).

The following child elements are defined for each **data-mcu-state** element:

- **hasContent:** An **xs:boolean** value that specifies whether the Web Conferencing MCU contains any content for the conference.
- **hasContentInMeeting:** An **xs:boolean** value that is "true" when both of the following conditions are met: 1) the Web Conferencing MCU contains content for the conference, and 2) the content is visible to participants other than the **organizer**.
- **hasPresentedContent:** An **xs:boolean** value that is "true" when both of the following conditions are met: 1) the Web Conferencing MCU contains content for the conference, and 2) the content is in the "presented" state.

2.2.2.10 permission-options Element Extensions

The **permission-options** extension is used to communicate potentially mutable permission values that affect the availability of various Web Conferencing **MCU** functionality to specific groups of participants within the **conference**.

The **permission-options** element is a container of **permission-option** elements, each describing the value and mutability of a particular permission for the Web Conferencing MCU in the conference.

The following child elements are defined for each **permission-option** element:

- **name:** An **xs:string** element identifying the permission option.
- **value:** An **xs:string** element describing the current value of the permission option.
- **mutable:** An **xs:boolean** element specifying whether the permission option value can be modified by clients by sending a **modifyConference** request to the MCU.

The Web Conferencing MCU SHOULD recognize the following permission option names and values. For additional details about Web Conferencing MCU-specific concepts, see [\[MS-PSOM\]](#).

- **PptAnnotationsAllowedPresenter:** The value is "true" if the Web Conferencing MCU allows participants with the role of "Presenter" in the conference to create annotations on PowerPoint content. Otherwise, the value is "false". If unspecified, the value SHOULD be assumed to be "false".
- **PptAnnotationsAllowedAttendee:** The value is "true" if the Web Conferencing MCU allows participants with the role of "Attendee" in the conference to create annotations on PowerPoint content. Otherwise, the value is "false". If unspecified, the value SHOULD be assumed to be "false".
- **AsynchronousBrowsingAllowedPresenter:** The value is "true" if the Web Conferencing MCU allows participants with the role of "Presenter" in the conference to browse content independently from the active presenter. Otherwise, the value is "false". If unspecified, the value SHOULD be assumed to be "false".
- **AsynchronousBrowsingAllowedAttendee:** The value is "true" if the Web Conferencing MCU allows participants with the role of "Attendee" in the conference to browse content independently from the active presenter. Otherwise, the value is "false". If unspecified, the value SHOULD be assumed to be "false".

2.2.2.11 permissions Element Extensions

The **permissions** extension is used to communicate static and immutable permission values which affect the availability of various Web Conferencing **MCU** functionality to specific groups of participants within the **conference**.

The **permissions** element is a container of **permission-type** elements, each describing the value of a particular permission for the Web Conferencing MCU in the conference.

The following child-elements are defined for each **permission-type** element:

- **name:** An **xs:string** element identifying the permission option.
- **value:** An **xs:string** element describing the current value of the permission option.

The Web Conferencing MCU SHOULD publish the following permission names and values. For additional details about Web Conferencing MCU-specific concepts, see [\[MS-PSOM\]](#).

- **EnableDataCollaboration:** The value is "false" if the Web Conferencing MCU will deny any participant in the conference from using Web Conferencing functionality. Otherwise, the value is "true". If unspecified, the value SHOULD be assumed to be "false".
- **AllowAnnotations:** The value is "false" if the Web Conferencing MCU will deny any participant in the conference from creating annotations on any type of content. Otherwise, the value is "true". If unspecified, the value SHOULD be assumed to be "false".
- **AllowExternalUsersToSaveContent:** The value is "false" if the Web Conferencing MCU will deny any anonymous or federated participant in the conference from downloading the original binary file contents for content on the Web Conferencing MCU. Otherwise, the value is "true". If unspecified, the value SHOULD be assumed to be "false".
- **EnableFileTransfer:** The value is "false" if the Web Conferencing MCU will deny any participant in the conference from downloading the original binary file contents for content on the Web Conferencing MCU. Otherwise the value is "true". If unspecified, the value SHOULD be assumed to be "false".
- **AllowQna:** The value is "false" if the Web Conferencing MCU will deny any participant in the conference from creating Q&A content. Otherwise, the value is "true". If unspecified, the value SHOULD be assumed to be "false".
- **AllowOfficeContent:** The value is "false" if the Web Conferencing MCU will deny any participant in the conference from creating Office content (for example, PowerPoint). Otherwise, the value is "true". If unspecified, the value SHOULD be assumed to be "false".

2.2.2.12 application/cccp+xml Document Format

The application/cccp+xml document format specifies the document format for the Centralized Conference Control Protocol (C3P), as specified in this protocol. A well-formed C3P document MUST be valid XML, as specified in [\[XML10\]](#), conformant to the C3P schema defined in section [6.2](#), and MUST be encoded using **UTF-8**, as specified in [\[RFC3629\]](#) section 3. The protocol includes requests and responses.

The cardinality of each extension element is specified in the XML schema using standard **minOccurs** and **maxOccurs** XSD conventions, unless explicitly specified otherwise in the following subsections. Similarly, the cardinality of each extension attribute is specified in the XML schema using the standard "required" attribute value. Similarly, the namespace of each extension attribute or element is specified in the XML schema using standard conventions and is omitted here for brevity.

Unless otherwise specified, implementations MUST ignore the elements and attributes that are not necessary for executing a particular command, as specified in section [2.2.2.2](#).

Unless otherwise specified, implementations MUST ignore extension elements and attributes that they cannot parse.

Requests and responses can further restrict this data model. Any such restrictions are specified by their message syntaxes, as needed.

2.2.3 C3P Request and Response Document Formats

This section specifies the command syntax for the C3P commands supported by the conferencing system. The supported C3P command set is a subset of the command set defined in the C3P schema. Each request or response document is carried inside a C3P request or response element, as specified in section [6.2](#).

The cardinality of each extension element is specified in the XML schema using standard **minOccurs** and **maxOccurs** XSD conventions, unless explicitly specified otherwise in the following subsections. Similarly, the cardinality of each extension attribute is specified in the XML schema using the standard "required" attribute value. Similarly, the namespace of each extension attribute or element is specified in the XML schema using standard conventions and is omitted here for brevity.

Unless otherwise specified, implementations MUST ignore the elements and attributes that are not necessary for executing a particular command, as specified in section [2.2.2.2](#).

Unless otherwise specified, implementations MUST ignore extension elements and attributes that they are not capable of parsing.

2.2.3.1 Requests

2.2.3.1.1 request Element

The **request** element is the root element of C3P requests. This element has the following attributes:

- **requestId**: The sender MUST generate a unique non-negative integer, within its local scope, and set **requestId** to this value. The **requestId** attribute is used to match requests and responses. Even though **requestId** is defined as an **xs:string**, it MUST be composed of numeric characters for decimal digits. In other words, it MUST be composed of the set of characters "0" through "9".
- **C3PVersion**: Entities compliant with this specification MUST set this to "1".
- **from**: The sender's **SIP URI**. This is identical to the URI in the **From** header field of the **SIP request** that carries the request body.
- **to**: The target's SIP URI. Unless otherwise specified, this is identical to the **conference-URI**.

Exactly one **conference control command** element MUST be included inside the **request** element. This is the case even though the schema supports specifying multiple commands for batching purposes. Conference control commands are defined as part of the protocol operation. However, many common elements that occur inside most commands are defined subsequently.

2.2.3.1.2 conferenceKeys Element

The **conferenceKeys** element specifies a **conference** in the context of a **conference control command**. This element has the following attributes:

- **confEntity**: Supplies the **conference-URI**. It MUST be a **SIP URI**.
- **Conference-Id**: Supplies the conference identifier, as defined in [\[MS-CONFPRO\]](#). This attribute is optional.
- **telemetry-id**:[<21>](#) Supplies an identifier the server can use to report telemetry data related to the requesting the client's conference signaling dialog. This attribute is optional and MUST be in the standard **GUID** format: {XXXXXXXX-XXXX-XXXX-XXXX-XXXXXXXXXXXX} where X is a hex digit (0,1,2,3,4,5,6,7,8,9,A,B,C,D,E,F).

2.2.3.1.3 userKeys Element

The **userKeys** element specifies a user in the context of a **conference control command**. This element has the following attributes:

- **confEntity**: The **conference-URI**. It MUST be a **SIP URI**.
- **userEntity attribute**: The participant URI. It MUST be a SIP URI.

2.2.3.1.4 endpointKeys element

The **endpointKeys** element specifies the **endpoint** of a user in the context of a **conference control command**. This element has the following attributes:

- **confEntity**: The **conference-URI**. It MUST be a **SIP URI**.
- **userEntity**: The participant URI. It MUST be a SIP URI.
- **endpointEntity attribute**: The **EPID**, typed as **xs:string**. Two **endpointEntity** attributes are considered equal if they are equal using XML **xs:string** element comparison rules. It is recommended that implementations generate a **GUID** and use it as the **endpointEntity** attribute.

2.2.3.1.5 mediaKeys Element

The **mediaKeys** element specifies the media session of an **endpoint** in the context of a **conference control command**. This element has the following attributes:

- **confEntity**: The **conference-URI**. It MUST be a **SIP URI**.
- **userEntity**: The participant URI. It MUST be a SIP URI.
- **endpointEntity**: The **EPID**, typed as **xs:string**. Two **endpointEntity** attributes are considered equal if they are equal using XML **xs:string** element comparison rules. It is recommended that implementations generate a **GUID** and use it as the **endpointEntity** attribute.
- **mediaId**: The media identifier that identifies a media session established between a client and an **MCU**. Extensions to this specification can specify the mechanism for establishing a media session with an MCU.

2.2.3.2 Responses

2.2.3.2.1 response Element

The **response** element is the root element of C3P responses. This element has the following attributes:

- **requestId**: Unique identifier for the response. This MUST be copied from the corresponding C3P request. Even though **requestId** is defined as an **xs:string**, it MUST be composed of the decimal digit characters in the set "0" through "9".
- **C3PVersion**: Entities compliant with this specification MUST set this to "1".
- **from**: The **SIP URI** of the sender. Implementations MUST populate this attribute from the **to** attribute of the corresponding request. Note that this is different from the standard SIP technique of generating responses that preserve the order of the **From** and **To** header fields.
- **to**: The SIP URI of the receiver. Implementations MUST populate this attribute from the **from** attribute of the corresponding request.
- **responder**: The SIP URI of the entity that actually generated this response, if multiple entities, such as the **focus** and an **MCU**, were involved in processing the request. This attribute is optional.

- **code**: Type of response. Valid values are "success", "pending", and "failure".
- **reason**: Specifies the failure reason. Values are defined in the schema.
- **displayString**: Specifies a failure reason phrase. This value can be used for client display purposes. It SHOULD NOT be used to make processing decisions.
- **timeout**: This attribute SHOULD NOT be set and SHOULD be ignored.
- **retryAfter**: Specifies a retry interval in seconds. This value can be used by the client to retry the command.
- **version**: This attribute MAY be set. It SHOULD be ignored if present.

Zero or one **conference control command** element MUST be included inside the **response** element. This is the case even though the schema supports specifying multiple commands for batching purposes. Conference control commands are defined as part of the protocol operation.

Implementations SHOULD be capable of handling C3P responses that have no command body inside the **response** envelope.

2.2.3.2.2 diagnostics-info Subelement

Zero or one instance of the **diagnostic-info** element SHOULD be present in the **response** element. The **diagnostic-info** element contains zero or more pairs of **key** and **value** elements that provide debugging and diagnostic information as follows.

The **diagnostics-info** subelement schema is as follows:

```

|
| | -- entry
| | | -- key
| | | -- value
|

```

The following keys are defined by this specification:

- **ms-diagnostics**
- **ms-diagnostics-public**

These keys have the same semantics as the corresponding headers with the same name in [\[MS-OCER\]](#).

The **value** element MUST be set to the header value constructed using the rules specified in [\[MS-OCER\]](#) for the header element of the same name.

An example of a **diagnostics-info** element is as follows:

```

<diagnostics-info>
  <entry>
    <key>ms-diagnostics</key>
    <value>1007;reason="Temporarily cannot route";source="sip.contoso.com";ErrorType="Connect Attempt Failure";WinsockFailureDescription="The peer actively refused the connection attempt";WinsockFailureCode="274D (WSAECONNREFUSED)";Peer="sip.fabrikam.com"
  </value>
  </entry>
</diagnostics-info>

```

Extensions to this specification can define other key-value pairs applicable to command responses.

2.2.3.3 addUser Request Document Format for Focus INVITE Requests

In addition to the syntax rules given in section 2.2.1 for C3P requests, the following additional rules for specific elements apply.

conferenceKeys: The **conference-URI** specified in the **confEntity** attribute of the **conferenceKeys** element MUST match the **SIP URI** in the **To** header field of the **INVITE** request.

The following rules apply to the **user** element:

- Exactly one **user** element MUST be present inside the **addUser** body.
- The **entity** attribute of the **user** element MUST be a SIP URI and MUST equal the SIP URI in the **From** header field in the corresponding INVITE request.
- Only the **roles** and **endpoint** child elements are permitted inside the **user** element. Each of these elements MUST be listed exactly once.

The following rules apply to the **roles** element:

- The **roles** element MUST be present and listed exactly once.
- The **entry** element MUST be populated with the desired role, which is either "presenter" or "attende", and exactly one **entry** element SHOULD be present.

The following rules apply to the **endpoint** element:

- The **endpoint** element SHOULD <22> contain a **session-on-behalf-of** element that indicates the user on behalf of whom the user is joining the **conference**.
- The **endpoint** element MUST specify a valid **entity** attribute. Implementations SHOULD use a **GUID** for this purpose.

Following is an example of an **addUser** document.

```
<addUser>
  <conferenceKeys
    confEntity="sip:user@fabrikam.com;gruu;opaque=app:conf:focus:id:BE92"/>
  <user entity="sip:user@fabrikam.com">
    <roles>
      <entry>attende</entry>
    </roles>
    <endpoint entity="{09AA504C-BA41-4458-8669-8F35470F6CA2}">
      <clientInfo
        xmlns="http://schemas.microsoft.com/rtc/2005/08/confinfoextensions" >
        <separator xmlns="urn:ietf:params:xml:ns:conference-info-separator" />
        <lobby-capable
          xmlns="http://schemas.microsoft.com/rtc/2008/12/confinfoextensions">
          true
        </lobby-capable>
      </clientInfo>
      <separator xmlns="urn:ietf:params:xml:ns:conference-info-separator"/>
      <session-on-behalf-of>
        <entity>sip:carol@fabrikam.com</entity>
      </session-on-behalf-of>
    </endpoint>
  </user>
</addUser>
```

2.2.3.4 addUser Response Document Format for Focus INVITE Responses

In addition to the syntax rules given in section [2.2.1](#) for C3P responses, the following additional rules apply.

conferenceKeys: This element MUST have the same values as those specified in the corresponding **addUser** request.

The following rules apply to the **user** element:

- Exactly one **user** element MUST be present inside the **addUser** body.
- The **entity** attribute of the **user** element MUST be the same as the **entity** attribute specified in the request.
- The **roles** element MUST be present and listed exactly once.
- The **endpoint** element SHOULD [<23>](#) contain a **session-on-behalf-of** element if it was present in the request. If the user is not joining the **conference**, the **endpoint** element SHOULD NOT be present in the response.

The following rules apply to the **roles** element:

- The **roles** element MUST be present and listed exactly once.
- The **entry** element MUST be populated with the granted role and exactly one **entry** element SHOULD be present. This might be different from the requested role in some cases because of policy.

The following example is an **addUser** document. Note that the conference ID is shown with four characters for readability, although it is a string with 8 to 32 alphanumeric characters, as defined in [\[MS-CONFPRO\]](#).

```
<addUser>
  <conferenceKeys
    confEntity="sip:user@fabrikam.com;gruu;opaque=app:conf:focus:id:BE92"/>
  <user entity="sip:user@fabrikam.com">
    <roles>
      <entry>attendee</entry>
    </roles>
    <clientInfo
      xmlns="http://schemas.microsoft.com/rtc/2005/08/confinfoextensions" >
      <separator xmlns="urn:ietf:params:xml:ns:conference-info-separator" />
      <lobby-capable
        xmlns="http://schemas.microsoft.com/rtc/2008/12/confinfoextensions">
        true
      </lobby-capable>
    </clientInfo>
    <separator xmlns="urn:ietf:params:xml:ns:conference-info-separator"/>
    <session-on-behalf-of>
      <entity>sip:carol@fabrikam.com</entity>
    </session-on-behalf-of>    </endpoint>
  </user>
</addUser>
```

2.2.3.5 endorseUser Request Document Format for Focus INVITE Requests

In addition to the syntax rules specified in section [2.2.1](#) for C3P requests, the following additional rules for specific elements apply. [<24>](#)

conferenceKeys: The **conference-URI** specified in the **confEntity** attribute of the **conferenceKeys** element MUST match the **SIP URI** in the **To** header field of the **INVITE** request.

endorsee: This element MUST contain the SIP URI of the participant to whose endpoint the **endorseUser** request pertains.

dialog-id: This element contains the following child elements, which together identify the **dialog** between the focus and the endorsed endpoint:

- **call-id:** The call identifier of the dialog between the focus and the endorsed endpoint.
- **from-tag:** The local identifier of the dialog between the focus and the endorsed endpoint.
- **to-tag:** The local identifier of the dialog between the focus and the endorsed endpoint.

2.2.3.6 endorseUser Response Document Format for Focus INVITE Responses

In addition to the syntax rules specified in section [2.2.1](#) for C3P responses, the following additional rules apply.

conferenceKeys: This element MUST have the same values as those specified in the corresponding **endorseUser** request.

result: This attribute MUST contain one of the following values:

- **success:** The **endorseUser** request was completed successfully.
- **otherFailure:** An error prevented the **endorseUser** request from completing successfully.

2.2.3.7 modifyUserRoles Request Document

In addition to the syntax rules given in section [2.2.1](#) for C3P requests, the following additional rules apply.

The following rules apply to the **userKeys** element:

- The **conference-URI** specified in the **confEntity** attribute of the **userKeys** element MUST match the **SIP URI** in the **To** header field of the INFO request.
- The **userEntity** attribute of the **userKeys** element MUST be a SIP URI.

The following rules apply to the **user-roles** element:

- The **user-roles** element MUST be present and listed exactly once.
- The **entry** element MUST be populated with the desired role, which is either "presenter" or "attende", and exactly one **entry** element SHOULD be present.

The following example is a **modifyUserRoles** request body:

```
<modifyUserRoles>
  <userKeys
    confEntity="sip:alice@fabrikam.com;gruu;opaque=app:conf:focus:id:5D3747C"
    userEntity="sip:cathy@fabrikam.com"/>
  <user-roles>
    <entry>presenter</entry>
  </user-roles>
</modifyUserRoles>
```

2.2.3.8 modifyUserRoles Response Document

In addition to the syntax rules given in section [2.2.1](#) for C3P responses, the following additional rules apply.

conferenceKeys: The **confEntity** attribute MUST have the same value as that specified in the corresponding request.

The following rules apply to the **user** element:

- Exactly one **user** element SHOULD be present inside the **modifyUserRoles** body.
- The **entity** attribute of the **user** element MUST be the same as the **userEntity** attribute specified in the request.

The following rules apply to the **roles** element:

- The **roles** element MUST be present and listed exactly once.
- The **entry** element MUST be populated with the new role and exactly one **entry** element SHOULD be present.

The following example is a **modifyUserRoles** response body:

```
<modifyUserRoles>
  <conferenceKeys
    confEntity="sip:alice@fabrikam.com;gruu;opaque=app:conf:focus:id:5D3747C"/>
  <user entity="sip:cathy@fabrikam.com">
    <roles>
      <entry>presenter</entry>
    </roles>
  </user>
</modifyUserRoles>
```

2.2.3.9 modifyConferenceLock Request Document

In addition to the syntax rules given in section [2.2.1](#) for C3P requests, the following additional rules apply.

conferenceKeys: The **conference-URI** specified in the **confEntity** attribute of the **conferenceKeys** element MUST match the **SIP URI** in the **To** header field of the INFO request.

The following rules apply to the **locked** element:

- The **locked** element MUST be included and it MUST specify the desired new lock state for the conference.
- A conference is considered locked whenever the locked value is set to "true", regardless of the value included in the **admission-policy** element.

The following rules apply to the **admission-policy** element:

- The **admission-policy** element is optional but, if included, the **autopromote** and **pstn-lobby-bypass** elements MUST also be included.
- The value of the **admission-policy** element MUST be set as defined in section [2.2.2.3](#).

The following rules apply to the **autopromote** element:

- The **autopromote** element is optional but, if included, the **admission-policy** and **pstn-lobby-bypass** elements MUST also be included.

- The value of the **autopromote** element MUST be set as defined in section 2.2.2.3.

The following rules apply to the **pstn-lobby-bypass** element:

- The **pstn-lobby-bypass** element is optional but, if included, the **admission-policy** and **autopromote** elements MUST also be included.
- The value of the **pstn-lobby-bypass** element MUST be set to either "true" or "false".

The following example is a **modifyConferenceLock** request body:

```
<modifyConferenceLock>
  <conferenceKeys
    confEntity="sip:alice@fabrikam.com;gruu;opaque=app:conf:focus:id:5D3747C"/>
  <locked>true</locked>
</modifyConferenceLock>
<modifyConferenceLock>
  <conferenceKeys
    confEntity="sip:alice@fabrikam.com;gruu;opaque=app:conf:focus:id:5D3747C"/>
  <locked>true</locked>
  <separator />
  <admission-policy>openAuthenticated</admission-policy>
  <autopromote>32768</autopromote>
  <pstn-lobby-bypass>false</pstn-lobby-bypass>
</modifyConferenceLock>
```

2.2.3.10 modifyConferenceLock Response Document

In addition to the syntax rules given in section [2.2.1](#) for C3P responses, the following additional rules apply.

conference-info element: The **entity** attribute MUST be set to the corresponding **confEntity** attribute specified in the **conferenceKeys** element of the request.

locked element: The **locked** element MUST be present and MUST specify the new lock state of the conference.

The following rules apply to the **admission-policy** element:

- The **admission-policy** element is optional but MUST be included if the **modifyConferenceLock** request included an **admission-policy** element along with the **autopromote** and **pstn-lobby-bypass** elements.
- It MUST specify the new admission policy applied to the **conference**.
- The value of the **admission-policy** element MUST be set as defined in section [2.2.2.3](#).

The following rules apply to the **autopromote** element:

- The **autopromote** element is optional but MUST be included if the **modifyConferenceLock** request included an **autopromote** element along with the **admission-policy** and **pstn-lobby-bypass** elements.
- It MUST specify the new automatic promotion applied to the conference.
- The value of the **autopromote** element MUST be set as defined in section 2.2.2.3.

The following rules apply to the **pstn-lobby-bypass** element:

- The **pstn-lobby-bypass** element is optional but MUST be included if the **modifyConferenceLock** request included a **pstn-lobby-bypass** element along with the **autopromote** and **admission-policy** elements.
- It MUST specify whether **PSTN** users can bypass the conference lobby.
- The value of the **pstn-lobby-bypass** element MUST be set to either "true" or "false".

The following example is a **modifyConferenceLock** response body:

```
<modifyConferenceLock>
  <conference-info
    entity="sip:alice@fabrikam.com;gruu;opaque=app:conf:focus:id:5D3747C"/>
  <locked>true</locked>
</modifyConferenceLock>
<modifyConferenceLock>
  <conference-info
    entity="sip:alice@fabrikam.com;gruu;opaque=app:conf:focus:id:5D3747C"/>
  <locked>true</locked>
  <separator />
  <admission-policy>openAuthenticated</admission-policy>
  <autopromote>32768</autopromote>
  <pstn-lobby-bypass>false</pstn-lobby-bypass>
</modifyConferenceLock>
```

2.2.3.11 deleteUser Request Document

In addition to the syntax rules given in section [2.2.1](#) for C3P requests, the following additional rules apply. The following rules apply to the **userKeys** element:

- The **conference-URI** specified in the **confEntity** attribute of the **conferenceKeys** element MUST match the **SIP URI** in the **To** header field of the INFO request.
- The **userEntity** attribute specifies the SIP URI of the user to be deleted.

endpointEntity: The **endpointEntity** element MUST be empty.

The following rules apply to the **client-reason** element:

- The **client-reason** element is optional.
- If the **client-reason** element is present, the value MUST be set to either "newPresenter", "participantEjected" or "connectedAtAnotherEndpoint".

The following example is a **deleteUser** request body:

```
<deleteUser>
  <userKeys
    confEntity="sip:alice@fabrikam.com;gruu;opaque=app:conf:focus:id:5D3747C"
    userEntity="sip:cathy@fabrikam.com"/>
</deleteUser>
```

2.2.3.12 deleteUser Response Document

In addition to the syntax rules given in section [2.2.1](#) for C3P responses, the following additional rules apply.

conferenceKeys: The **confEntity** attribute MUST be set to the same value as the one specified in the corresponding request.

The following rules apply to the **user** element:

- The **user** element MUST be included in success responses.
- The **entity** attribute of the **user** element MUST be the same as the **userEntity** attribute supplied in the corresponding request.

The following example is a **deleteUser** response body:

```
<deleteUser>
  <conferenceKeys
    confEntity="sip:alice@fabrikam.com;gruu;opaque=app:conf:focus:id:5D3747C" />
  <user entity="sip:cathy@fabrikam.com"/>
</deleteUser>
```

2.2.3.13 deleteConference Request Document

In addition to the syntax rules given in section [2.2.1](#) for C3P requests, the following additional rule applies.

conferenceKeys: The **conference-URI** specified in the **confEntity** attribute of the **conferenceKeys** element MUST match the **SIP URI** in the **To** header field of the INFO request.

The following example is a **deleteConference** request body:

```
<deleteConference>
  <conferenceKeys confEntity="sip:alice@fabrikam.com;gruu;opaque=app:conf:focus:id:5D3747C"/>
</deleteConference>
```

2.2.3.14 deleteConference Response Document

In addition to the syntax rules given in section [2.2.1](#) for C3P responses, the following additional rule applies.

conference-info: The **entity** attribute MUST be set to the **confEntity** attribute specified in the corresponding request.

The following example is a **deleteConference** response body:

```
<deleteConference>
  <conference-info entity="sip:alice@fabrikam.com;gruu;opaque=app:conf:focus:id:5D3747C"/>
</deleteConference>
```

2.2.3.15 addUser Dial-out Request Document

In addition to the syntax rules given in section [2.2.1](#) for C3P requests, the following additional rules apply.

conferenceKeys: The **conference-URI** specified in the **confEntity** attribute of the **conferenceKeys** element MUST match the **SIP URI** in the **To** header field of the **INVITE** request.

The following rules apply to the **user** element:

- Exactly one **user** element MUST be present inside the **addUser** body.

- The **entity** attribute of the **user** element MUST be a SIP URI.

The following rules apply to the **roles** element:

- Zero or one **roles** element MUST be present inside the **user** element.
- The **entry** element MUST be populated with the desired role.

The following rules apply to the **endpoint** element:

- Zero or one **endpoint** element MUST be present inside the **user** element.
- The **endpoint** element MUST specify a valid **entity** attribute. Implementations SHOULD use a **GUID** for this purpose.
- The **endpoint-uri** attribute can be specified. If specified, it MUST be a "sip:" URI or a "tel:" URI.
- The **refer-to-uri** attribute can be specified. If specified, it MUST be a "sip:" URI or a "tel:" URI.
- The **joining-method** element MUST be populated with the value "dialed-out".
- The **accessMethod** and **authMethod** elements MUST be left empty when sent from the client.

mcuUri: The **mcuUri** attribute MUST be populated with the **MCU-Conference-URI** of the **MCU** that needs to execute the **addUser** dial-out command. Valid values are "IMMCU" and "AVMCU". "ASMCU" and "DMCU" are not supported.

Extensions to this specification can specify the semantics of other elements and attributes.

The following example is an **addUser** request document:

```
<addUser mcuUri="sip:alice@fabrikam.com;gruu;opaque=app:conf:chat:id:5D3747C">
  <conferenceKeys confEntity="sip:alice@fabrikam.com;gruu;opaque=app:conf:focus:id:5D3747C"/>
  <user entity="sip:cathy@fabrikam.com">
    <display-text>Cathy Baker</display-text>
    <roles>
      <entry>presenter</entry>
    </roles>
    <endpoint entity="{5CD3FC0A-05F7-4A17-A95B-430A28FC9EFA}"
      endpoint-uri="sip:cathy@fabrikam.com;opaque=user:epid:123;gruu">
      <joining-method>dialed-out</joining-method>
      <!-- other extension elements can follow -->
    </endpoint>
  </user>
</addUser>
```

2.2.3.16 addUser Dial-out Response Document

In addition to the syntax rules given in section [2.2.1](#) for C3P responses, the following additional rules apply.

conferenceKeys: The **confEntity** attribute of this element MUST be set to the **confEntity** value specified in the corresponding **addUser** request.

The following rules apply to the **user** element:

- Exactly one **user** element MUST be present inside the **addUser** body. The **user** element MUST have the same **entity** attribute as the one specified in the **addUser** request.
- The **roles** element SHOULD be populated from the corresponding request.

The following rules apply to the **endpoint** element:

- Zero or one **endpoint** element SHOULD be present inside the **user** element.
- The **endpoint** element MUST specify a valid **entity** attribute. It MUST be the same as the one present in the corresponding request.
- The **endpoint-uri** attribute can be specified. If specified, it MUST be a "sip:" **URI** or a "tel:" URI.
- The **joining-method** element MUST be populated with the value "dialed-out".

Extensions to this specification can specify the semantics of other elements and attributes.

The following example is an **addUser** response document:

```
<addUser >
  <conferenceKeys confEntity="sip:alice@fabrikam.com;gruu;opaque=app:conf:focus:id:5D3747C"/>
  <user entity="sip:cathy@fabrikam.com">
    <display-text>Cathy Baker</display-text>
    <roles>
      <entry>presenter</entry>
    </roles>
    <endpoint entity="{5CD3FC0A-05F7-4A17-A95B-430A28FC9EFA}"
    endpoint-uri="sip:cathy@fabrikam.com;opaque=user:epid:123;gruu">
      <joining-method>dialed-out</joining-method>
      <!-- other extension elements can follow -->
    </endpoint>
  </user>
</addUser>
```

2.2.3.17 addUser Dial-in Request Document

In addition to the syntax rules given in section [2.2.1](#) for C3P requests, the following additional rules apply.

conferenceKeys: The **conference-URI** specified in the **confEntity** attribute of the **conferenceKeys** element MUST match the **SIP URI** of the **To** header field of the **INVITE** request.

The following rules apply to the **user** element:

- One **user** element instance MUST be present inside the **addUser** body.
- The **entity** attribute of the **user** element MUST be a SIP URI.
- The **entity** attribute MUST be set to the C3P **from** attribute.

The following rules apply to the **roles** element:

- Zero or one **roles** element SHOULD be present inside the **user** element.
- The **roles** element MUST be populated with the desired role, which is either "presenter" or "attendee".
- If the **roles** element is absent, the default value is "attendee".

The following rules apply to the **endpoint** element:

- Zero or one **endpoint** element SHOULD be present inside the **user** element.
- The **endpoint** element MUST specify a valid **entity** attribute. Implementations SHOULD use a **GUID** for this purpose.

- The **endpoint-uri** attribute can be specified. If specified, it MUST be a "sip:" URI or a "tel:" URI.
- The **refer-to-uri** attribute can be specified. If specified, it MUST be a "sip:" URI or a "tel:" URI.
- The **joining-method** element MUST be populated with the value "dialed-in".
- The **accessMethod** and **authMethod** elements MUST be left empty.

The following rules apply to the **mcuUri** attribute:

- The **mcuUri** attribute MUST be populated with the **MCU-Conference-URI** of the **MCU** that needs to execute the **addUser** dial-in command.
- Extensions to this specification can specify the semantics of other elements and attributes.

The following example is an **addUser** request document:

```
<addUser mcuUri="sip:alice@fabrikam.com;gruu;opaque=app:conf:chat:id:5D3747C">
  <conferenceKeys confEntity="sip:alice@fabrikam.com;gruu;opaque=app:conf:focus:id:5D3747C"/>
  <user entity="sip:cathy@fabrikam.com">
    <display-text>Cathy Baker</display-text>
    <roles>
      <entry>presenter</entry>
    </roles>
    <endpoint entity="{5CD3FC0A-05F7-4A17-A95B-430A28FC9EFA}"
  endpoint-uri="sip:cathy@fabrikam.com;opaque=user:epid:123;gruu">
    <joining-method>dialed-in</joining-method>
    <!-- other extension elements can follow -->
  </endpoint>
</user>
</addUser>
```

2.2.3.18 addUser Dial-in Response Document

In addition to the syntax rules given in section [2.2.1](#) for C3P responses, the following additional rules apply.

conferenceKeys: This element MUST have the same values as those specified in the corresponding **addUser** request.

The following rules apply to the **user** element:

- Exactly one **user** element MUST be present inside the **addUser** body.
- The **user** element MUST have the same **entity** attribute specified in the **addUser** request.
- The **roles** element SHOULD be populated from the corresponding request.

The following rules apply to the **endpoint** element:

- Zero or one **endpoint** element SHOULD be present inside the **user** element.
- The **endpoint** element MUST specify a valid **entity** attribute. It MUST be the same as the one present in the corresponding request.
- The **endpoint-uri** attribute can be specified. If specified, it MUST be a "sip:" **URI** or a "tel:" URI.
- The **joining-method** element MUST be populated with the value "dialed-in".

The following rules apply to the **connection-info** element:

- Zero or more **entry** subelements SHOULD be present inside the **connection-info** element.

- Each **entry** element specifies a key-value property pair.

The following well-known keys are defined by this protocol. Their usage is discussed in section 3. They are case-insensitive.

- **Mcu-Server-Uri**: Specifies a **SIP** URI that can be used to send requests to this **MCU**. This SIP URI SHOULD be constructed in such a way that it can be used as the remote-target URI of **SIP requests**, as defined in [\[RFC3261\]](#) section 12.2.1.1.
- **Mcu-Conference-Uri**: Specifies the **MCU-Conference-URI** defined earlier.

The following well-known keys are defined by this protocol specifically for the Web Conferencing MCU. They are case-sensitive. For additional details about Web Conferencing MCU-specific concepts, see [\[MS-PSOM\]](#).

- **sAuthId**: An **xs:string** value composed of decimal digits and the letters "A", "B", "C", "D", "E", and "F". The Web Conferencing MCU MUST send this value, and it MUST be uniquely generated so that it is not duplicated in any other **addUser** dial-in response.
- **pwrpc.modes**: An **xs:string** value of either "tls" or "fwdtls". The Web Conferencing MCU MUST send this value to the client.
- **pwrpc.port**: An **xs:string** value containing a decimal string indicating the port number that the client can use to establish a PSOM connection to the Web Conferencing MCU. The Web Conferencing MCU MUST send this key to the client.
- **pwrpc.authPattern**: An **xs:string** value that indicates the authentication mechanism supported by the Web Conferencing server. This MUST be set to the string "<sAuthId>".
- **numberOfProxies**: An **xs:string** value containing a decimal string indicating how many proxy servers are being communicated from the Web Conferencing MCU to the client. This value is used by the client to look for specific keys of the form "proxy[N].FQDN" and **proxy[N].Port**. The Web Conferencing MCU MUST send this key to the client if it also sent the **pwrpc.modes** key with a value of "fwdtls".
- **proxy[N].FQDN**: Any key with a name of the form "proxy[N].FQDN", where **N** is a normalized decimal string less than the value of the **numberOfProxies** key sent to the client, and greater than or equal to zero. Any key of this form has an **xs:string** value indicating the **fully qualified domain name (FQDN)** of a proxy server capable of establishing a PSOM connection to the Web Conferencing MCU on behalf of the client. The Web Conferencing MCU MUST send a key of this form for every value of **N** from zero up to, but not including, the value of the **numberOfProxies** key.
- **proxy[N].Port**: Any key with a name of the form "proxy[N].Port" where **N** is a normalized decimal string less than the value of the **numberOfProxies** key sent to the client, and greater than or equal to zero. Any key of this form has an **xs:string** value containing a decimal string indicating the port number of a proxy server capable of establishing a PSOM connection to the Web Conferencing MCU on behalf of the client. The Web Conferencing MCU MUST send a key of this form for every value of **N** from zero up to, but not including, the value of the **numberOfProxies** key.
- **pwrpc.pwsURI**: An **xs:string** value containing a URI for the Web Conferencing MCU that the client can use to establish a PSOM connection. The Web Conferencing MCU MUST send this key to the client if it also sent the **pwrpc.modes** key with a value of "tls".
- **alternativeName**: An **xs:string** value that can be used in place of the **X.509** certificate subject for **TLS** negotiation. If the Web Conferencing MCU has sent the **pwrpc.modes** key with a value of "fwdtls", the client MUST ignore this value. Otherwise, the Web Conferencing MCU MUST send this key, and the client MUST establish TLS negotiation using this value as the certificate subject for verification.

Extensions to this specification can specify the semantics of other elements and attributes.

The following example is an **addUser** response document:

```
<addUser mcuUri="sip:alice@fabrikam.com;gruu;opaque=app:conf:chat:id:5D3747C">
  <conferenceKeys confEntity="sip:alice@fabrikam.com;gruu;opaque=app:conf:focus:id:5D3747C"/>
  <user entity="sip:cathy@fabrikam.com">
    <display-text>Cathy Baker</display-text>
    <roles>
      <entry>presenter</entry>
    </roles>
    <endpoint entity="{5CD3FC0A-05F7-4A17-A95B-430A28FC9EFA}"
  endpoint-uri="sip:cathy@fabrikam.com;opaque=user:epid:123;gruu">
    <joining-method>dialed-in</joining-method>
    <!-- other extension elements can follow -->
  </endpoint>
</user>
<connection-info>
  <entry>
    <key>Mcu-Server-Uri</key>
    <value>sip:mcu.domain.com:5061;transport=tls</value>
  </entry>
  <entry>
    <key>Mcu-Conference-Uri</key>
    <value> sip:alice@fabrikam.com;gruu;opaque=app:conf:chat:focus:id:5D3747C</value>
  </entry>
</connection-info>
</addUser>
```

2.2.3.19 getConference Request Document

This section follows the product behavior described in endnote [<25>](#).

In addition to the syntax rules given in section [2.2.1](#) for C3P requests, the request follows the same syntax as the **getConference** request sent to the **Focus Factory**, as specified in [\[MS-CONFPRO\]](#).

The difference between the **getConference** request sent to the Focus Factory, specified in [\[MS-CONFPRO\]](#), and the one sent to the **focus** is that the one sent to the Focus Factory retrieves the static provisioning information of the **conference**, while the one sent to the focus retrieves the current roster state of an active conference.

2.2.3.20 getConference Response Document

This section follows the product behavior described in product behavior note [<26>](#).

In addition to the syntax rules given in section [2.2.1](#) for a C3P response, the additional rules given in section [3.12.4.1](#) apply.

2.2.3.21 setLobbyAccess Request Document

In addition to the syntax rules given in section [2.2.1](#) for C3P requests [<27>](#), the following additional rules apply.

conferenceKeys: The **conference-URI** specified in the **confEntity** attribute of the **conferenceKeys** element MUST match the **SIP URI** of the **To** header field of the **INVITE** request.

The following rules apply to the **userEntity** element:

- One or more **userEntity** element instances MUST be present inside the **setLobbyAccess** body.
- The value of a **userEntity** element MUST be set to a SIP URI.

The following rules apply to the **access** element:

- One **access** element instance MUST be present inside the **setLobbyAccess** body.
- The value of the **access** element MUST be set to "granted" or "denied".

2.2.3.22 setLobbyAccess Response Document

In addition to the syntax rules given in section [2.2.1](#) for C3P responses<28>, the following additional rules apply.

conferenceKeys: This element MUST have the same values as those specified in the corresponding **setLobbyAccess** request.

The following rules apply to the **status** element:

- One **status** element MUST be included for each user admitted or denied from the conference in the **setLobbyAccess** request.
- A **status** element MUST have one **reason** attribute set to "success", "conferenceFull", "userDoesntExist" or "alreadyGranted".
- A **status** element MUST have one **userEntity** element.

2.2.3.23 modifyEndpoint Request Document

In addition to the syntax rules given in section [2.2.1](#) for C3P requests, the following additional rules apply.

The following rules apply to the **endpointKeys** element:

- One **endpointKeys** element instance MUST be present inside the **modifyEndpoint** body.
- The conference-URI specified in the **confEntity** attribute of the **endpointKeys** element MUST match the **SIP URI** of the **To** field of the **INVITE** request.

The following rules apply to the **endpoint** element:

- One **endpoint** element instance MUST be present inside the **modifyEndpoint** body.
- The value of the **entity** attribute MUST have the same value as that specified in the **endpointEntity** attribute in **endpointKeys** in the same request.

The following example is a **modifyEndpoint** request document:

```
<modifyEndpoint>
  <endpointKeys confEntity="sip:bob@fabrikam.com;gruu;opaque=app:conf:focus:id:97DJ3DYH"
  userEntity="sip:bob@fabrikam.com" endpointEntity="{F95CF5F8-2A22-4C1F-B65E-2014CF07BD11}"/>
  <ci:endpoint xmlns:ci="urn:ietf:params:xml:ns:conference-info" entity="{F95CF5F8-2A22-
  4C1F-B65E-2014CF07BD11}">
    <!-- other extension elements can follow -->
  </ci:endpoint>
</modifyEndpoint>
```

2.2.3.24 modifyEndpoint Response Document

In addition to the syntax rules given in section [2.2.1](#) for C3P responses, the following additional rules apply.

The **modifyEndpoint** command modifies the current **endpoint** only. There is no requirement to identify which user has been modified in the response.

The following example is a **modifyEndpoint** response document:

```
<modifyEndpoint/>
```

No child element is needed for the **modifyEndpoint** element in response.

2.2.3.25 **modifyConferenceAnnouncements Request Document**

This document is defined in [\[MS-CONFAV\]](#) section 2.2.3.4, with an example in [\[MS-CONFAV\]](#) section 4.4.

2.2.3.26 **modifyConferenceAnnouncements Response Document**

The rules for this document are defined in [\[MS-CONFAV\]](#) section 3.2.5.5, with an example in [\[MS-CONFAV\]](#) section 4.4.

2.2.3.27 **modifyConference Request Document**

In addition to the syntax rules given in section [2.2.1](#) for C3P requests, the following additional rules apply.

- The **mcuUri** attribute MUST NOT be empty.
- The **conference-info** element MUST contain only one **conference-view** element, and no other child elements.
- The **conference-view** element MUST contain only one **entity-view** element, and no other child elements.
- The **entity** attribute of the **entity-view** element MUST match the value of the **modifyConference.mcuUri** attribute.

2.2.3.28 **modifyConference Response Document**

In addition to the syntax rules given in section [2.2.1](#) for C3P responses, the following additional rules apply.

- The **conference-info.entity** attribute MUST be set to the **confEntity** attribute specified in the corresponding request.
- The **conference-info** element MUST have its state set to partial.
- The **conference-info** element MUST contain no other child elements.

2.2.4 **Conference Roster Document Format**

The constructed conference roster MUST be a valid XML document conforming to the conference schema defined in section [6.2](#).

The format for constructing the relevant subelements of the conference roster is given in the following subsections.

Unless specified otherwise, if a roster element has a **state** attribute associated with it, rules for constructing it follow [\[RFC4575\]](#) section 4.4.

2.2.4.1 conference-description Element Syntax

The **conference-description** element MUST be constructed with the **conf-uris** element populated using the rules specified in section [2.2.2.4](#).

2.2.4.2 Participant user Element Syntax

The **focus** MUST generate a **user** element for each participant in the **conference** using the following rules:

- The **user** element MUST be valid according to the application/conference-info+xml syntax rules.
- The focus MUST populate the **roles** subelement with the granted role of the user.
- The focus SHOULD populate the **display-text** subelement with the display name of the user as obtained from the corresponding **addUser** request or using some other directory lookup.
- The focus MUST add an **endpoint** element for each focus-connected **endpoint** using the focus **endpoint** element syntax rules defined in section [2.2.4.2.1](#).
- The focus MUST add an **endpoint** element for each MCU-connected endpoint using the MCU **endpoint** element syntax rules defined in section [2.2.4.2.2](#).
- The focus MUST populate the **endorser** attribute with the **URI** of the last endpoint that issued a successful **endorseUser** request for this participant, as defined in section [2.2.3.5](#). If no **endpoint** has endorsed this user, the focus MUST NOT populate this attribute. [<29>](#)
- The focus MUST populate the **endorser-display-name** attribute with the display name of the last endpoint that issued a successful **endorseUser** request for this participant, as defined in section [2.2.3.5](#). If no endpoint has endorsed this user, the focus MUST NOT populate this attribute. [<30>](#)
- The focus MUST populate the **device-type** attribute if the sip uri of user connected to the conference corresponds with a meeting room device; the value of this attribute in this case will be "meetingRoom". The focus MUST NOT populate this attribute for any other device type.
- The focus MAY preserve all other elements, except the **endpoint** elements, and attributes specified in the **user** element of the **addUser** request and add it to the **user** element it constructs for notification purposes.

An example of a **user** element is as follows:

```
<user entity="sip:alice@fabrikam.com" state="full">
  <display-text>Alice Gates</display-text>
  <roles>
    <entry>presenter</entry>
  </roles>
  <endpoint entity="{09AA504C-BA41-4458-8669-8F35470F6CA2}" session-type="focus" endpoint-
uri="sip:alice@fabrikam.com;opaque=user:epid:HT07tI-f3F-fdDyic8rblwAA;gruu">
    <status>connected</status>
  </endpoint>
</user>
```

2.2.4.2.1 Focus endpoint Element Syntax

The **focus** MUST generate an **endpoint** element for each focus-connected **endpoint** of a **conference** participant using the following rules:

- The **entity** attribute of the **endpoint** element MUST have the same value that was specified in the corresponding **addUser** request used by the client at the time it connected to the focus.
- The **session-type** attribute of the **endpoint** element MUST be set to the value "focus".
- The focus SHOULD populate the **endpoint-uri** attribute with an **endpoint URI**. Normally, for GRUU-based clients, this is the **endpoint GRUU** specified in the **Contact** header field of the corresponding **INVITE** request. If an **endpoint GRUU** is available from the corresponding INVITE request, it SHOULD be preferred over any **endpoint-uri** value specified in the **addUser** request itself.
- The **status** subelement MUST be set to either the value "connected" or the value "on-hold". The value "connected" indicates a user who has been admitted to the conference. The value "on-hold" indicates a user placed in the **lobby**.
- The focus MAY preserve all other elements and attributes specified in the **endpoint** element of the **addUser** request and add it to the **endpoint** element it constructs for notification purposes.

An example of a focus **endpoint** element is as follows:

```
<endpoint entity="{09AA504C-BA41-4458-8669-8F35470F6CA2}" session-type="focus" endpoint-
uri="sip:alice@fabrikam.com;opaque=user:epid:HT07tI-f3F-fdDyic8rblwAA;gruu">
  <status>connected</status>
</endpoint>
```

2.2.4.2.2 MCU endpoint Element Syntax

The **focus** MUST generate an **endpoint** element for each MCU-connected **endpoint** of a **conference** participant using the following rules:

- The focus MUST preserve all elements and attributes of the **endpoint** element published by the **MCU** and use it to construct the **endpoint** element.
- The **session-type** attribute of the **endpoint** element MUST be set according to the semantics defined for the **session-type** attribute defined in section 2.2.2.6, thereby overriding any **session-type** attribute set by the MCU.
- The **status** element MUST be populated with a value as defined in the XML schema. Only the "connected" value SHOULD be used in **notifications**.

MCU-specific extensions to this specification can specify additional syntax rules for generating MCU **endpoint** elements.

2.2.4.3 Participant-count Attribute Syntax

The **participant count** attribute provides the exact number of participants in the meeting. [<31>](#) The **focus** sends the count in the users element. The focus MUST NOT send this attribute for participants in the lobby. The **participant-count** attribute is of type "xs:unsignedInt" and is optional.

An example of a **participant-count** attribute is as follows:

```
<conference-info xmlns="urn:ietf:params:xml:ns:conference-info"
xmlns:mhci="http://schemas.microsoft.com/rtc/2005/08/confinfoextensions"
xmlns:mhci2="http://schemas.microsoft.com/rtc/2008/12/confinfoextensions"
xmlns:cis="urn:ietf:params:xml:ns:conference-info-separator"
entity="sip:test1@vdomain.com;gruu;opaque=app:conf:focus:id:6WFMS54F" state="partial"
version="36" static="false">

  <users state="partial" mchi:participant-count="25">
```

2.2.4.4 conference-view Element Syntax

In full **conference notifications**, the **focus** MUST generate a **conference-view** element using the following rules:

- The focus MUST add an **entity-view** element for itself using the focus **entity-view** element syntax rules that follow.
- The focus MUST add any **entity-view** elements published by **MCUs** in the conference to the roster document.

2.2.4.4.1 Focus entity-view Element Syntax

The **focus** MUST construct and include an **entity-view** element for itself in the conference roster. The constructed **entity-view** element MUST conform to the following additional rules:

- The **entity-state** element MUST be populated in "full" **entity-view notifications**.
- The **entity-state** element MUST list the current lock state of the **conference**.

Following is an example of an **entity-view** element for the focus.

```
<entity-view state="full" entity="sip:alice@fabrikam.com;gruu;opaque=app:conf:focus:id:BE92">
  <entity-state>
    <locked>false</locked>
  </entity-state>
</entity-view>
```

2.2.5 MCU Conference Roster Document Format

The **conference** roster document published by an **MCU** to the **focus** MUST conform to the following rules, in addition to being a valid application/conference-info+xml document, as defined in section [6.3](#).

The following rules apply to the **endpoint** element:

- Zero or one **endpoint** element MUST be listed inside a **user** element.
- The **state** attribute of the **endpoint** element MUST be set to "full" or "deleted".

The following rules apply to the **conference-view** element:

- Exactly one **entity-view** entry SHOULD be present inside the **conference-view** element. This entry MUST have the entity **URI** set to the **MCU-Conference-URI**.
- The size of the XML fragment for each child element of **entity-view** MUST NOT exceed 2048 bytes.

2.2.6 HTTP Request and Response

This section follows the product behavior described in product behavior note [<32>](#).

2.2.6.1 HTTP Request

From browsers: The HTTP request from the client side browser will hit the Join Manager, which will first detect the supported browser versions. If the client's type of browser and version is supported, the Join Manager will then respond back with an HTML document containing a script that needs to run on the client side. This script detects and picks the client to launch; it makes use of the protocol handler detection APIs provided for this purpose. [<33>](#)

From within clients: The client application can also make an in-band HTTP request directly to the Join Manager with a special Accept header to acquire the XML content necessary to join the meeting directly without launching the browser. It will use the following special headers for this request:

```
Accept: Application/vnd.microsoft.lync.meeting+xml;ver=15.0
User-Agent: Lync/15.0 (Windows M.N/XX, YY)
```

Where:

```
Windows M.N: Release version for Windows OS
XX: x86/x64 bitness for Windows OS
YY: x86/x64 bitness for Lync client
```

2.2.6.2 HTTP Response

Browser Request: The Join Manager responds back to the client side browser with an HTML document that contains the script described in section [2.2.6.4](#). The Join Manager generates an XML document body that **MUST** conform to the response format defined in section [2.2.6.3](#), and sets this as one of the parameters in the script.

Client Request: The Join Manager responds back to the client with an XML document that contains the same XML document called out in section [2.2.6.3](#).

2.2.6.3 ocsmeet Document Format

The ocsmeet document format specifies the document format of the XML document body sent back in the HTTP response that the Join Manager sends to the browser, and this is embedded as a string in the script present in the document. A well-formed XML document string **MUST** be valid XML, as specified in [\[XML10\]](#), conformant to the schema defined in section [6.1](#).

The cardinality of each element is specified in the XML schema using standard **minOccurs** and **maxOccurs** XSD conventions, unless explicitly specified otherwise.

Unless otherwise specified, implementations **MUST** ignore elements and attributes that they cannot parse.

conf-uri: This element **MUST** be set to the parsed **conference URI (conference-URI)** or an empty string if the conferencing join web **URL** could not be parsed.

server-time: This element **MUST** be set to the time in milliseconds taken by Join Manager to process the request.

original-incoming-url: This element **MUST** be set to the original URL that the user requested.

conf-key: This element **MUST** be set to the conference key of the **conference**.

fallback-url: [<34>](#) This element **MUST** be set to the alternate URL that desktop and mobile clients can use when a join fails for some reason.

ucwa-url: [<35>](#) This element **MUST** be set to the UCWA (Unified Communications Web API) server URL that mobile and web clients can use to connect to the conference.

ucwa-ext-url: [<36>](#) This element **MUST** be set to the UCWA (Unified Communications Web API) server URL that mobile and web clients outside an organization's network can use to connect to the conference.

ucwa-int-url:[<37>](#) This element MUST be set to the UCWA (Unified Communications Web API) server URL that mobile and web clients within an organization's network can use to connect to the conference.

telemetry-id:[<38>](#) This element MUST be set to a **GUID** value used for tracking end-to-end join time telemetry information.

The following example is a content body:

```
<conf-info xmlns:xsi="http://www.w3.org/2001/XMLSchema-instance"
xmlns:xsd="http://www.w3.org/2001/XMLSchema"
xmlns="http://schemas.microsoft.com/rtc/2009/05/simplejoinconfdoc">
  <conf-uri>sip:bob@fabrikam.com;gruu;opaque=app:conf:focus:id:MJMAY7RF</conf-uri>
  <server-time>1.0001</server-time>
  <original-incoming-url>https://www.fabrikam.com/meet/bob/MJMAY7RF</original-incoming-url>
  <conf-key>MJMAY7RF</conf-key>
  <fallback-url>https://www.fabrikam.com/meet/bob/MJMAY7RF?sl=1</fallback-url>
  <ucwa-url>https://www.fabrikam.com/ucwa/applications</ucwa-url>
  <ucwa-ext-url>https://www.fabrikam.com/ucwa/applications</ucwa-ext-url>
  <ucwa-int-url>https://webpool.fabrikam.com/ucwa/applications</ucwa-int-url>
  <telemetry-id>00bfd6b5-6cd3-4327-b6e1-7c3aa0deac52</telemetry-id>
</conf-info>
```

2.2.6.4 Simple Join JavaScript

The following examples are the HTML document and the JavaScript code that the Join Manager sends back to the client in response to the HTTP request sent on the simple join URL.

The following example is the main HTML document:

```
<html xmlns="http://www.w3.org/1999/xhtml" class="reachJoinHtml">
<head>
  <title>Microsoft Lync 2010</title>
  <script type="text/javascript">
    var reachURL =
      "https://fabrikam.com/Reach/Client/WebPages/ReachJoin.aspx?xml=PD94bWwgdmVyc2lvbj0iMS4wIiBlbm
      NvZGluc2VudD0idXRmLTgiPz48Y29uZi1pbmZvIHhtbG5zOnhzaT0iaHR0cDovL3d3dy53My5vcmcvMjAwMS9YTUxTY2hlbWE
      taW5zdGFuY2UiIHhtbG5zOnhzaT0iaHR0cDovL3d3dy53My5vcmcvMjAwMS9YTUxTY2hlbWEiIHhtbG5zPSJodHRwOi8v
      c2NoZW1hcy5taWNyb3NvZnQuY29tL3J0Yy8yMDA5LzAlL3NpbXBsZWpvaW5jb25mZG9jIj48Y29uZi1lcmk-
      c2lwOnNOZXZlY2hAbWljcm9zb2Z0LmNvbTtncnV1O29wYXFlZT1hcHA6Y29uZjpm2N1czppZDpJVCU0s3VzwvY29uZ
      i1lcmk-PHNlcnZlci10aw11PjE8L3NlcnZlci10aw11PjxvcmlnaW5hbC1pbmNvbWluZy11cmw-
      aHR0cHM6Ly9sc2xtODQubWVldC5taWNyb3NvZnQuY29tL211ZXQvc3RldmVjaC9JQ1VCU0s3VzwvY29uZjpm2N1czppZDpJVCU0s3VzwvY29uZi1rZXk-PC9jb25mLWluZm8-";

    /* Escaped ocsmeet XML document Body */
    var escapedXML = "&lt;?xml version='1.0' encoding='utf-
    8'&gt;&lt;conf-info xmlns:xsi='http://www.w3.org/2001/XMLSchema-instance'
    xmlns:xsd='http://www.w3.org/2001/XMLSchema'
    xmlns='http://schemas.microsoft.com/rtc/2009/05/simplejoinconfdoc'&gt;&lt;conf-
    uri&gt; sip:bob@fabrikam.com;gruu;opaque=app:conf:focus:id:IBUBSK7W&lt;/conf-
    uri&gt;&lt;server-time&gt;1&lt;/server-time&gt;&lt;original-incoming-url&gt;
    https://fabrikam.com/meet/bob/IBUBSK7W &lt;/original-incoming-url&gt;&lt;conf-
    key&gt;IBUBSK7W&lt;/conf-key&gt;&lt;/conf-info&gt;";

    var showJoinUsingLegacyClientLink = "True";
    var urlCrackingError = "False";
    var currentLanguage = "en-US";
  </script>

  /* Including JavaScript code */
  /*
  Utilities.js -
  Contains other methods such methods that verify if the browser version is supported*/
```

```

        <script type="text/javascript" src="/meet/JavaScript/Utilities.js"></script>

/*
  PluginLoader.js -
  Contains classes and methods that contain configuration and loading of ActiveX control or
  Firefox Plug-in
  */
  <script type="text/javascript" src="/meet/JavaScript/PluginLoader.js"></script>

/*
  Launch.js -
  Contains the OnLoad() method and the related code that invokes utility functions, does
  supported browser checks, loads available ActiveX Control or Firefox plug-ins, shortlists the
  candidate and invokes Launch API on it. It would also contain fall back code to launch the
  web offering, provide links to alternate clients, and provide a help link. It will also close
  the browser window in case of a successful launch.
  */
  <script type="text/javascript" src="/meet/JavaScript/Launch.js"></script>

  <link rel="Stylesheet" type="text/css" href="/meet/Resources/ReachClient.css" />
</head>
<body onload="mainWindow.OnLoad();" class="reachJoinBody">

/* HTML BODY goes here, typically there is an IFrame here and JavaScript populates the
content */

</body>
</html>

```

The following example is PluginLoader.js:



```

var InstalledClient = new Object( );
InstalledClient.OC = 0;
InstalledClient.Samara = 1;
InstalledClient.AOC = 2;

//
// Name = Registered name of the Plugin
//
PluginConfigOC =
{
  IE:
  {
    Version_Name:      "CommunicatorMeetingJoinAx.JoinManager"
  },
  FF:
  {
    Version_CLSID:    "application/vnd.microsoft.communicator.ocsmeeting"
  }
}

PluginConfigSamara =
{
  IE:
  {
    Version_Name:      "AttendantConsoleMeetingJoinAx.JoinManager"
  },
  FF:
  {
    Version_CLSID:    "application/vnd.microsoft.attendantconsole.ocsmeeting"
  }
}

PluginConfigAOC =
{

```

```

IE:
{
  Version_Name:      "CommunicatorAttendeeMeetingJoinAx.JoinManager"
},

FF:
{
  Version_CLSID:     "application/vnd.microsoft.communicatorattendee.ocsmeeting"
}
}

// Format the string
function StringFormat()
{
  var argumentList = StringFormat.arguments;
  var argsLen = argumentList.length;

  if(!argsLen)
  {
    return "";
  }
  else
  {
    var newString = argumentList[0];
    var tmp = argsLen - 1;

    for(var i = 0; i < tmp; ++i)
    {
      // '$' is a special character in regular expression
      // if there is '$_' in string, it will break this function in IE
      // Replace it with '$$'
      newString = newString.replace(new RegExp("%" + i, "g"), (argumentList[i + 1] +
      "").replace(/\$/g, "$$$$"));
    }

    return newString;
  }
}

function CreateNodeOutside(nodeType, nodeId)
{
  var node = document.createElement(nodeType || "DIV");
  document.body.appendChild(node);

  node.style.position = "absolute";
  node.style.width = "1px";
  node.style.height = "1px";
  node.style.left = "-100px";
  node.style.top = "0px";
  node.style.overflow = "hidden";
  node.style.visibility = "hidden";

  if (nodeId != null)
    node.id = nodeId;

  return node;
}

function GetBrowserTag()
{
  var browserTag = "";
  if (isIE())
  {
    browserTag = "IE";
  }
  else
  {
    // Treat all non-IE browsers the same as Firefox
    // the reason being, Opera/Chrome/Safari all look

```

```

        // for plugins in the Mozilla folder and load them
        // even if they were not installed for this browser.
        browserTag = "FF";
    }

    return browserTag;
}

function GetConfigForClient(installedClient, configTag)
{
    var config;

    switch (installedClient)
    {
        case InstalledClient.OC:
            config = PluginConfigOC[configTag];
            break;
        case InstalledClient.Samara:
            config = PluginConfigSamara[configTag];
            break;
        case InstalledClient.AOC:
            config = PluginConfigAOC[configTag];
            break;
        default:
            break;
    }

    return config;
}

//
// A general component used to load any plugin into browser (IE & Firefox)
//
function PluginLoader()
{
    this.isIE = null;
    this._name = null;
    this._clsname = null;
    this._clsid = null;
    this._initProps = null;

    // the loaded plugin object
    this._pluginInstance = new Object();
}

PluginLoader.IdPrefix = " ucclient plugin ";
PluginLoader.TagHtmlTemplateIE = "<object classid='%0'%1></object>";
PluginLoader.TagHtmlTemplateFF = "<embed type='%0'%1></embed>";

//
// Initialize it with plugin information, such as name and id.
//
PluginLoader.prototype.Initialize = function(name, clsname, clsid, initProps)
{
    if (this._pluginInstance.object)
    {
        return;
    }

    this._isIE = (document.all != null);
    this._name = name;
    this._clsname = clsname;
    this._clsid = clsid;
    this._initProps = initProps;
}

//
// Load plugin
//

```

```

PluginLoader.prototype.LoadPlugin = function()
{
    if (this._pluginInstance.object)
    {
        return this._pluginInstance;
    }

    this._CreatePlugin();
    return this._pluginInstance;
}

//
// UnLoad plugin
//
PluginLoader.prototype.UnloadPlugin = function()
{
    if (!this.pluginInstance.object)
    {
        return;
    }

    //if it created a dom object, remove it.
    if ((this.clsname == null) && (this.clsid != null))
    {
        try
        {
            var createdContainerNode = this._pluginInstance.object.parentNode;
            Assert(createdContainerNode != null && createdContainerNode.parentNode ==
document.body, "Plugin parent node is not correct");
            document.body.removeChild(createdContainerNode);
        }
        catch( ex )
        {
            // Error in removing DOM object.
            return;
        }
    }

    this._pluginInstance.object = null;
    return;
}

PluginLoader.prototype._IsPluginAvailable = function()
{
    var isAvailable = false;

    // Check for the availability of the Plugin
    // before actually trying to load the Plugin
    // in case of non-IE browsers: this prevents
    // the "gold bar" indicating "Additional plugins
    // are required to display all the media on the
    // page" that comes in Firefox and other browsers.
    if (!this._isIE)
    {
        var mimetype = navigator.mimeTypes[this._clsid];

        if (mimetype)
        {
            var enabled = mimetype.enabledPlugin;

            if (enabled != null)
            {
                isAvailable = true;
            }
        }
    }

    return isAvailable;
}

```

```

//
// Create the plugin object
//
PluginLoader.prototype._CreatePlugin = function()
{
    if (this._clsname)
    {
        try
        {
            if (this.isIE)
            {
                this._pluginInstance.object = new ActiveXObject(this._clsname);
            }
            else
            {
                this.pluginInstance.object = null;
            }
        }
        catch( ex )
        {
            // Error creating ActiveX object.
        }
    }
    else if (this._clsid)
    {
        if (!this._IsPluginAvailable())
        {
            return;
        }

        var propStr = "";
        if (this._initProps)
        {
            var props = this._initProps;
            for (var key in props)
            {
                propStr += " " + key + "=" + props[key] + " ";
            }
        }

        var tagHtml = StringFormat(this.isIE ? PluginLoader.TagHtmlTemplateIE :
PluginLoader.TagHtmlTemplateFF, this._clsid, propStr);

        try
        {
            var containerNode = CreateNodeOutside("DIV");
            containerNode.innerHTML = tagHtml;
            var node = containerNode.firstChild;
            node.id = PluginLoader.IdPrefix + this._name;
            this._pluginInstance.object = node;
        }
        catch( ex )
        {
            // Error creating DOM object.
        }
    }
}

```

The following example is Launch.js:

```

// Constants
var MINIMUM_CLIENT_VERSION = 14;
var REDIRECT_TO_REACH_SL_OVERRIDE = 'sl=';

// This is CU2 HF3 build # as this is when OC / AOC plugin dlls were updated in the build.
var MINOR_CLIENT_VERSION_FOR_CU2 = "7577.280";

```

```

// Plugin Loaders for each client
var pluginLoaderOC = null;
var pluginLoaderSamara = null;
var pluginLoaderAOC = null;

// Plugin Objects for each client
var pluginObjectOC = null;
var pluginObjectSamara = null;
var pluginObjectAOC = null;

// Version info for each client
var majorVersionOC = null;
var majorVersionSamara = null;
var majorVersionAOC = null;

var minorVersionOC = null;
var minorVersionAOC = null;
var minorVersionSamara = null;

var majorVersionOCCapability = null;
var majorVersionAOCCapability = null;
var majorVersionSamaraCapability = null;

var defaultExperienceVersion = "1400";
var newExperienceVersion = "1500";
var serverBusyErrorCode = "7";

var ResourceURL = "";

var isMobileDevice = false;
var isNokiaDevice = false;
var isAndroidDevice = false;
var isWinPhoneDevice = false;
var isIPhoneDevice = false;
var isIPadDevice = false;

// Initialize with some default values
var lyncJoinConferenceUrl = "lync://";
var lync15JoinConferenceUrl = "lync15:";
var lync15DesktopJoinConfUrl = "lync15classic:";
var lync15MobileJoinConfUrl = "lync15://";
var mlxJoinConfUrl = "lync15mlx:";

var confJoinParams = "confjoin?url=";

var isImmersiveIE = false;
var noAppTimeout = 1500;

var loading = "true";

//
// Initialize resource strings before we try to use them.
//
var txt_languageSettingsLabel = "";
var txt_launchRichClientHeaderLabel = "";
var txt_launchRichClientTextLabel = "";
var txt_unableToJoinLabel = "";
var txt_onlineHelpLink = "";
var txt_copyRightTextLabel = "";
var textDirection="";
var txt_joinUsingReachLink = "";
var txt_connecting = "";
var txt_unableToLaunchLyncMobile = "";
var txt_unableToLaunchLyncMobile2 = "";
var txt_unsupportedMobileDevice = "";

var txt_immersiveIESwitch = "In Internet Explorer, click on the Page Tools button on the
address bar, and then click on Use desktop view. Lync will then connect you to the meeting.";

```

```

var txt_64bitbrowserUnsupportedLabel = "";
var txt_64bitUnsupportedText1 = "";
var txt_64bitUnsupportedOption1 = "";
var txt_64bitJoinUsingLync = "";
var txt_64bitUnsupportedOption2 = "";

// Add any new resource strings here.

var requestArray = new Array(10);

function MainForm()
{
    this.connection = new ConnectionObject();
}

MainForm.prototype.GetMinorVersion = function (fullVersion) {
    if (fullVersion == null) {
        return null;
    }

    var minorVersion = 0.0;

    // Full version number string format: "4.0.1234.5678"
    // Minor version number string format: "1234.5678"
    // Ignore any non-numeric characters preceding the version number start
    if (/(\D*)(\d\.(\d)\.(\d{4})\.(\d+))/.test(fullVersion)) {
        var minorVersionString = RegExp.$3;
        minorVersion = parseFloat(minorVersionString);
    }
    return minorVersion;
}

MainForm.prototype.GetMajorVersion = function(fullVersion)
{
    if (fullVersion == null)
    {
        return null;
    }

    var majorVersion = "";

    // Full version number string format: "4.0.1234.5678"
    // Major version number string format: "4.0"
    // Ignore any non-numeric characters preceding the version number start
    if (/(\D*)(\d\.(\d)\.(\d{4})\.(\d+))/.test(fullVersion)) {
        majorVersion = RegExp.$2;
    }
    return majorVersion;
}

MainForm.prototype.GetClientBasedOnCapability = function(capabilities)
{
    if (capabilities == null)
    {
        return null;
    }

    //assign it as 14 by default
    majorVersionCapability = 14;

    var clientVersion = "";
    if (/((([a-z\-\_]*):(\d+\.\d+)(,*)*)*)/.test(capabilities)) {
        majorVersionEncoded = RegExp.$2;
        minorVersionEncoded = RegExp.$3;
        // We dont look at the minorVersion yet since we dont need to block any CUs in 15
    }
}
yet.

```



```

        if (majorVersionEncoded == "ms-launch-lync")
        {
            majorVersionCapability = 15;
        }

        if (majorVersionEncoded == "ms-launch-ocsmeet")
        {
            majorVersionCapability = 14;
        }

        if (majorVersionEncoded == "ms-launch-conf")
        {
            majorVersionCapability = 13;
        }
    }
    return majorVersionCapability;
}

MainForm.prototype.OnLoad = function () {

    // Javascript is enabled,
    if (document.URL.indexOf("closeme") >= 0) {
        this.ClosePage();
        return;
    }

    // un-hide the Language dropdown.
    // hide the 15 experience table for now
    document.getElementById("mainTable15").style.display = "none";
    document.getElementById("languageSettingsDiv").style.display = "block";
    document.getElementById("languageSettingsDiv15").style.display = "block";
    document.getElementById("languageSettingsDivMobile").style.display = "block";
    document.getElementById("errorLogo").style.display = "none";
    document.getElementById("officeImageError").style.display = "none";
    document.getElementById("footer").className = "";

    this.UpdateSelectedLanguage(currentLanguage);

    // Fetch the current language resources.
    this.GetUpdatedResources(currentLanguage);
}

MainForm.prototype.OnLoadComplete = function () {
    loading = "false";

    lyncJoinConferenceUrl = mobileW1ProtocolHandler.toLowerCase() + confJoinParams;
    lync15MobileJoinConfUrl = mobileW2ProtocolHandler.toLowerCase() + confJoinParams;
    lync15DesktopJoinConfUrl = lync15ClassicProtocolHandler.toLowerCase() + confJoinParams;
    lync15JoinConferenceUrl = lync15CommonProtocolHandler.toLowerCase() + confJoinParams;
    mlxJoinConfUrl = mlxProtocolHandler.toLowerCase() + confJoinParams;

    var unsupportedDevice = isUnsupported.toLowerCase();
    if (unsupportedDevice == "true") {

        if (userExperience.toLowerCase() != defaultExperienceVersion) {
            document.getElementById("UnknownMobileDeviceDiv15").style.display = "block";
            document.getElementById("unknownMobileDeviceLabel15").innerHTML =
txt_unsupportedMobileDevice;
        }
        else {
            document.getElementById("UnknownMobileDeviceDiv").style.display = "block";
            document.getElementById("unknownMobileDeviceLabel").innerHTML =
txt_unsupportedMobileDevice;
        }
        document.getElementById("launchReachLink").style.display = "none";
        return;
    }
}

```

```

//
// Make sure Meeting is valid
//
var valid = validMeeting.toLowerCase();
if (valid == "false") {
    this.ShowError();
    return;
}
var fwdurl = domainOwnerJoinLauncherUrl.toLowerCase();
if (fwdurl != "") {
    domainOwnerJoinLauncherUrl = domainOwnerJoinLauncherUrl + "&url=" + document.URL;
    // Redirect the user to the correct join launcher
    this.RedirectToReach(domainOwnerJoinLauncherUrl);
    return;
}

//
// Initialize version info of all clients
//
this.InitializeVersionInformationOfAllClients();

//
// Do something here as cracking was received
//
var reachRequested = reachClientRequested.toLowerCase();
if (reachRequested == "true") {
    this.RedirectToReach(reachURL);
    return;
}

var lwaRequested = htmlLwaClientRequested.toLowerCase();
if (lwaRequested == "true") {
    var resp = confirm("Welcome! You are participating in Lync 15 Technical Preview and
today is Lync Web App day (LWA Day).\n\n" +
        "Every LWA Day, you'll be joining meetings using Lync Web App by default instead
of the installed Lync client. " +
        "Please take this opportunity to put our web client through its paces 'cause we
want to know what you think.\n\n " +
        "If you need to, you can switch to the installed Lync client by clicking Cancel
button.");

    if (resp) {
        this.RedirectToReach(reachURL);
        return;
    }
}

isMobileDevice = isMobile.toLowerCase();
if (isMobileDevice == "true") {
    isNokiaDevice = isNokia.toLowerCase();
    isAndroidDevice = isAndroid.toLowerCase();
    isWinPhoneDevice = isWinPhone.toLowerCase();
    isIPhoneDevice = isIPhone.toLowerCase();
    isIPadDevice = isIPad.toLowerCase();
    lyncJoinConferenceUrl = lyncJoinConferenceUrl + document.URL;
    lync15MobileJoinConfUrl = lync15MobileJoinConfUrl + document.URL;

    if (isNokiaDevice == "true" || isIPhoneDevice == "true" || isIPadDevice == "true" ||
isWinPhoneDevice == "true" || isAndroidDevice == "true") {

        var lyncDownloadFromOviUrl = "";

        if (isNokiaDevice == "true") {
            lyncDownloadFromOviUrl = "http://go.microsoft.com/fwlink/?LinkId=217188";
        }

        if (isIPhoneDevice == "true") {

```

```

        lyncDownloadFromOviUrl = "http://go.microsoft.com/fwlink/?LinkId=217185";
    }

    if (isIPadDevice == "true") {
        lyncDownloadFromOviUrl = "http://go.microsoft.com/fwlink/?LinkId=217187";
    }

    if (isWinPhoneDevice == "true") {
        lyncDownloadFromOviUrl = "http://go.microsoft.com/fwlink/?LinkId=217184";
    }

    if (isAndroidDevice == "true") {
        lyncDownloadFromOviUrl = "http://go.microsoft.com/fwlink/?LinkId=217189";
    }

    // Try to launch lync with the lyncJoinLaunchUrl. Start the timeout in parallel,
    // After timeout, redirect to install page.
    document.getElementById("launchReachLink").style.display = "none";

    if (userExperience.toLowerCase() != defaultExperienceVersion) {
        document.getElementById("mobileinterimDiv15").style.display = "block";
        document.getElementById("connectingLabel15").innerHTML = txt_connecting;
    }
    else {
        document.getElementById("mobileinterimDiv").style.display = "block";
        document.getElementById("connectingLabel").innerHTML = txt_connecting;
    }

    if (isIPhoneDevice == "true" || isIPadDevice == "true") {
        window.frames["launchReachFrame"].location = lync15MobileJoinConfUrl;

        setTimeout(function () {
            window.frames["launchReachFrame"].location = lyncJoinConferenceUrl;

            setTimeout(function () {
                if (userExperience.toLowerCase() != defaultExperienceVersion) {
                    document.getElementById("mobileappstoreDiv15").style.display =
"block";
                    //document.getElementById("copyRightInfoDiv").style.display =
"block";
                    document.getElementById("mobileinterimDiv15").style.display =
"none";
                    document.getElementById("mobileappstoreLabel15").innerHTML =
txt_unableToLaunchLyncMobile;

                    document.getElementById("mobileappstoreLabel315").innerHTML =
txt_unableToLaunchLyncMobile3;

                    document.getElementById("mobileappstoreLabel215").setAttribute('href',
lyncDownloadFromOviUrl);
                    document.getElementById("mobileappstoreLabel215").innerHTML =
txt_unableToLaunchLyncMobile2;
                }
                else {
                    document.getElementById("mobileappstoreDiv").style.display =
"block";
                    document.getElementById("mobileinterimDiv").style.display =
"none";
                    document.getElementById("mobileappstoreLabel").innerHTML =
txt_unableToLaunchLyncMobile;

                    document.getElementById("mobileappstoreLabel2").setAttribute('href', lyncDownloadFromOviUrl);
                    document.getElementById("mobileappstoreLabel2").innerHTML =
txt_unableToLaunchLyncMobile2;
                }
            }, noAppTimeout);
        }, noAppTimeout);
    }

```

```

        }, noAppTimeout);
    }
    // For all the other devices (android, WinPhone, Nokia?) continue to launch using
the same technique
    else {
        window.frames["launchReachFrame"].location = lyncJoinConferenceUrl;

        setTimeout(function () {
            if (userExperience.toLowerCase() != defaultExperienceVersion) {
                document.getElementById("mobileappstoreDiv15").style.display =
"block";
                //document.getElementById("copyRightInfoDiv").style.display =
"block";

                document.getElementById("mobileinterimDiv15").style.display = "none";
                document.getElementById("mobileappstoreLabel15").innerHTML =
txt_unableToLaunchLyncMobile;

                document.getElementById("mobileappstoreLabel315").innerHTML =
txt_unableToLaunchLyncMobile3;

                document.getElementById("mobileappstoreLabel215").setAttribute('href',
lyncDownloadFromOviUrl);
                document.getElementById("mobileappstoreLabel215").innerHTML =
txt_unableToLaunchLyncMobile2;
            }
            else {
                document.getElementById("mobileappstoreDiv").style.display = "block";
                document.getElementById("mobileinterimDiv").style.display = "none";
                document.getElementById("mobileappstoreLabel").innerHTML =
txt_unableToLaunchLyncMobile;

                document.getElementById("mobileappstoreLabel2").setAttribute('href',
lyncDownloadFromOviUrl);
                document.getElementById("mobileappstoreLabel2").innerHTML =
txt_unableToLaunchLyncMobile2;
            }
        }, noAppTimeout);
    }
}
return;
}

//
// Initialize version info of all clients
//
this.InitializeVersionInformationOfAllClients();

// MLX DCR: Check if MLX has requested an escalation to Lync desktop.
var desktopescalate = escalateToDesktop.toLowerCase();

// Before checking for the plugin, now we should look for the Lync15:// protocol handler
// only on Win8 or ARM devices
if (isWin8() || isArm()) {

    // Check if the new API msLaunchUri is available or not.
    if (navigator.msLaunchUri) {

        // If its available, look if Escalation is ON from MLX
        if (desktopescalate == "true") {
            // Yes, launch using Lync15Desktop to ensure to NOT launch MLX
            // if the detection/launch was successful, close the page.
            // if it was unsuccessful, try to launch a client usig Active X next.
            navigator.msLaunchUri(lync15DesktopJoinConfUrl + document.URL,
this.PrepareToClosePage, this.LaunchUsingActiveX);
        }
        else {

```

```

        // No, launch using common Lync15:// to ensure we launch whichever is default
        MLX, W15 or W14 CU7
        navigator.msLaunchUri(lync15JoinConferenceUrl + document.URL,
        this.PrepareToClosePage, this.LaunchUsingActiveX);
    }
    return;
}

if (navigator.msProtocols) {
    // This means the protocol handler detection API is available.
    // we must be on IE10 or mo-bro or higher
    //     if (lync15mlx:// not found) {
    //         if (can use ActiveX) // IE 10 classic
    //             use ActiveX to launch
    //         else // IE 10 metro
    //             use Protocol Handler
    //     }

    // References:http://msdn.microsoft.com/en-us/library/hh772146(v=vs.85).aspx
    if (navigator.msProtocols["lync15mlx"] == undefined || desktopescalate == "true")
    {
        // => This means MLX is NOT installed or is installed but we have to pretend
        as if it isn't (desktopescalation scenario)

        // Check if conf: is Registered
        if (navigator.msProtocols["conf"] != undefined) {
            // => Conf: is registered so W14 or above client is installed.

            // Check if the plugin can be loaded.
            if (majorVersionAOC == null && majorVersionOC == null &&
            majorVersionSamara == null) {
                // => Plugin info can not be found/loaded

                //References: http://blogs.msdn.com/b/ie/archive/2011/05/02/activex-
                filtering-for-developers.aspx
                if (typeof window.external.msActiveXFilteringEnabled != "undefined")
                {
                    if (window.external.msActiveXFilteringEnabled() == false) {
                        // => We're in immersive mode as activeXFiltering is false
                        but plugin is NOT found.

                        // Check if Lync 15 is installed using the Lync15 specific
                        protocol handler
                        if (navigator.msProtocols["lync15desktop"] != undefined) {
                            window.frames["launchReachFrame"].location =
                            lync15DesktopJoinConfUrl + encodeURIComponent(document.URL);
                            return;
                        }
                    } // msActiveXFilteringCheck
                }
            } // Plugin can be loaded or not
        } // conf check
    }
    else {
        // MLX is installed and desktop escalation is false
        // Launch Lync15:// blindly as MLX and all other clients are expected to
        register for Lync15://
        window.frames["launchReachFrame"].location = lync15JoinConferenceUrl +
        encodeURIComponent(document.URL);
        return;
    }
}

if (isArm()) {
    this.RedirectToReach(reachURL);
    return;
}
}

```

```

        this.LaunchUsingActiveX();
    }

    MainForm.prototype.LaunchUsingActiveX = function()
    {
        var isHtmlLwaEnabled = isLwaEnabled.toLowerCase();

        // Treat MAC OS separately. We need to take the users to LWA only if the 15 HTML LWA is
        // enabled.
        if (isMacOS() && isHtmlLwaEnabled == "true") {
            MainForm.prototype.RedirectToReach(reachURL);
            return;
        }

        //
        // Now that we have the installed clients and
        // their version info, figure out which client
        // to launch and try to launch it.
        //
        var launched = "false";

        var blockprecu2clients = blockPreCU2Clients.toLowerCase();

        try {
            if ((majorVersionOC != null) && (majorVersionOCCapability >= MINIMUM_CLIENT_VERSION))
            {
                if (blockprecu2clients == "true" && minorVersionOC <
                MINOR_CLIENT_VERSION_FOR_CU2) {
                    // do not launch OC here as we need to block these.
                    // instead show error message and an option to launch LWA
                    MainForm.prototype.ShowClientBlockScreen();
                    return;
                }
                else {
                    // Launch using OC plugin
                    // Note: OC Plugin launches whichever client ran last (OC/Samara)
                    pluginObjectOC.object.LaunchUCClient(escapedXML);
                    launched = "true";
                    MainForm.prototype.DisplayInstalledClientLaunchedPage("oc");
                }
            }
            else if ((majorVersionSamara != null) && (majorVersionSamaraCapability >=
            MINIMUM_CLIENT_VERSION)) {
                // Launch using Samara plugin
                // Note: Samara Plugin launches whichever client ran last (OC/Samara)
                pluginObjectSamara.object.LaunchUCClient(escapedXML);
                launched = "true";
                MainForm.prototype.DisplayInstalledClientLaunchedPage("oc");
            }
            // make sure to launch AOC only when HTML LWA is NOT enabled
            else if ((isHtmlLwaEnabled == "false") && (majorVersionAOC != null) &&
            (majorVersionAOCcapability >= MINIMUM_CLIENT_VERSION)) {
                if (blockprecu2clients == "true" && minorVersionAOC <
                MINOR_CLIENT_VERSION_FOR_CU2) {
                    // do not launch OC here as we need to block these.
                    // instead show error message and an option to launch LWA
                    MainForm.prototype.ShowClientBlockScreen();
                    return;
                }
                else {
                    // Launch using AOC plugin
                    // Note: AOC Plugin launches only AOC
                    pluginObjectAOC.object.LaunchUCClient(escapedXML);
                    launched = "true";
                    MainForm.prototype.DisplayInstalledClientLaunchedPage("aoc");
                }
            }
        }
        catch (ex) {

```

```

        // Failed to launch client
        launched = "false";
    }

    //
    // Unload all Plugins
    //
    MainForm.prototype.UnloadAllPlugins();

    if (launched == "false") {
        // Either we failed to detect an installed client OR
        // the installed client is not the right version OR
        // launching the installed client failed.
        // Redirect to Reach.

        MainForm.prototype.RedirectToReach(reachURL);
    }
    else {
        // We managed to successfully launch the client to join
        // the meeting, try to close the browser window on the
        // browsers that support closing it silently
        MainForm.prototype.PrepareToClosePage();
    }
}

MainForm.prototype.PrepareToClosePage = function () {

    // We only close the page on selected IE browsers.
    // We dont do it on FF/Chrome etc other browsers.
    // So, if we're not on IE, lets not reload the page with ?closeme=1 in the first place

    if (!isIE()) {
        return;
    }

    var currentUrl = window.location.href;

    if (currentUrl.indexOf("&url=") < 0) {
        MainForm.prototype.ClosePage();
        return;
    }
    else {

        var newUrl = currentUrl.substring(currentUrl.indexOf("&url=") + 5);

        if (newUrl.indexOf("?") >= 0) {
            newUrl = newUrl + "&";
        }
        else {
            newUrl = newUrl + "?";
        }

        newUrl = newUrl + "closeme=1";
        window.location.href = newUrl;
    }
}

MainForm.prototype.InitializeVersionInformationOfAllClients = function()
{
    try
    {
        navigator.plugins.refresh();
    } catch (ex) {
        // no need to do anything here
    }

    // First determine the browser tag
    // needed to look up the config for
    // the clients

```

```

    var configTag = GetBrowserTag();

    this.InitializeVersionInformationForOC(configTag);
    this.InitializeVersionInformationForSamara(configTag);
    this.InitializeVersionInformationForAOC(configTag);
}

MainForm.prototype.InitializeVersionInformationForOC = function(configTag)
{
    var pluginConfig = GetConfigForClient(InstalledClient.OC, configTag);
    if (!pluginConfig)
    {
        return;
    }

    pluginLoaderOC = new PluginLoader();
    pluginLoaderOC.Initialize(
        "OC",
        pluginConfig.Version Name,
        pluginConfig.Version_CLSID,
        null);

    pluginObjectOC = pluginLoaderOC.LoadPlugin();
    if (!pluginObjectOC.object)
    {
        return;
    }

    try
    {
        var fullVersionOC = pluginObjectOC.object.GetVersionString();
        majorVersionOC = this.GetMajorVersion(fullVersionOC);
        minorVersionOC = this.GetMinorVersion(fullVersionOC);

        var clientCapabilities = pluginObjectOC.object.GetSupportedProtocolVersionString();
        majorVersionOCCapability = this.GetClientBasedOnCapability(clientCapabilities);
    } catch (ex) {
        // Unable to get version details, continue anyway
    }
}

MainForm.prototype.InitializeVersionInformationForSamara = function(configTag)
{
    var pluginConfig = GetConfigForClient(InstalledClient.Samara, configTag);
    if (!pluginConfig)
    {
        return;
    }

    pluginLoaderSamara = new PluginLoader();
    pluginLoaderSamara.Initialize(
        "Samara",
        pluginConfig.Version Name,
        pluginConfig.Version_CLSID,
        null);

    pluginObjectSamara = pluginLoaderSamara.LoadPlugin();
    if (!pluginObjectSamara.object)
    {
        return;
    }

    try
    {
        var fullVersionSamara = pluginObjectSamara.object.GetVersionString();
        majorVersionSamara = this.GetMajorVersion(fullVersionSamara);
    }
}

```



```

        var clientCapabilities =
pluginObjectSamara.object.GetSupportedProtocolVersionString();
        majorVersionSamaraCapability = this.GetClientBasedOnCapability(clientCapabilities);

    } catch (ex) {
        // Unable to get version details, continue anyway
    }
}

MainForm.prototype.InitializeVersionInformationForAOC = function(configTag)
{
    var pluginConfig = GetConfigForClient(InstalledClient.AOC, configTag);
    if (!pluginConfig)
    {
        return;
    }

    pluginLoaderAOC = new PluginLoader();
    pluginLoaderAOC.Initialize(
        "AOC",
        pluginConfig.Version_Name,
        pluginConfig.Version_CLSID,
        null);

    pluginObjectAOC = pluginLoaderAOC.LoadPlugin();
    if (!pluginObjectAOC.object)
    {
        return;
    }

    try
    {
        var fullVersionAOC = pluginObjectAOC.object.GetVersionString();
        majorVersionAOC = this.GetMajorVersion(fullVersionAOC);
        minorVersionAOC = this.GetMinorVersion(fullVersionAOC);

        var clientCapabilities = pluginObjectAOC.object.GetSupportedProtocolVersionString();
        majorVersionAOCCapability = this.GetClientBasedOnCapability(clientCapabilities);

    } catch (ex) {
        // Unable to get version details, continue anyway
    }
}

MainForm.prototype.UnloadAllPlugins = function()
{
    // Unload all Plugins so that references to the DLLs are released

    // Unload OC Plugin
    if (pluginLoaderOC != null)
    {
        pluginLoaderOC.UnloadPlugin();
    }

    // Unload Samara Plugin
    if (pluginLoaderSamara != null)
    {
        pluginLoaderSamara.UnloadPlugin();
    }

    // Unload AOC Plugin
    if (pluginLoaderAOC != null)
    {
        pluginLoaderAOC.UnloadPlugin();
    }
}

MainForm.prototype.ShowClientBlockScreen = function () {
    if (userExperience.toLowerCase() != defaultExperienceVersion) {

```

```

        document.getElementById("UnsupportedClientBlockDiv15").style.display = "block";

        document.getElementById("UnsupportedClientBlockMessageLabel15").innerHTML =
txt_UnsupportedLyncVersion1;
        document.getElementById("JoinUsingLWAOption115").innerHTML =
txt_UnsupportedLyncVersion2;
        document.getElementById("JoinMeetingUsingLWA_Link15").innerHTML =
txt_UnsupportedLyncVersion3;
        document.getElementById("JoinMeetingUsingLWA_Link15").href = reachURL;
    }
    else {
        document.getElementById("UnsupportedClientBlockDiv").style.display = "block";

        document.getElementById("UnsupportedClientBlockMessageLabel").innerHTML =
txt_UnsupportedLyncVersion1;
        document.getElementById("JoinUsingLWAOption1").innerHTML =
txt_UnsupportedLyncVersion2;
        document.getElementById("JoinMeetingUsingLWA_Link").innerHTML =
txt_UnsupportedLyncVersion3;
        document.getElementById("JoinMeetingUsingLWA_Link").href = reachURL;
    }
}

MainForm.prototype.ShowError = function () {

    if (userExperience.toLowerCase() != defaultExperienceVersion) {
        document.getElementById("joinLauncherErrorDiv15").style.display = "block";

        if (errorCode == serverBusyErrorCode) {
            document.getElementById("errorTextLabel15").innerHTML =
conferenceErrorServerBusy1;
            document.getElementById("checkUrlLabel15").innerHTML =
conferenceErrorServerBusy2;
        }
        else {
            document.getElementById("errorTextLabel15").innerHTML = conferenceError1;
            document.getElementById("checkUrlLabel15").innerHTML = conferenceError2;
        }

        document.getElementById("errorTextLabel15").style.display = "block";
        document.getElementById("checkUrlLabel15").style.display = "block";

        document.getElementById("diagLabel15").innerHTML = diag;
        document.getElementById("diagLabel15").style.display = "block";
        var diagInfoTextString = diagInfo.toString();
        document.getElementById("diagInfoText15").value = diagInfoTextString;
        document.getElementById("diagInfoText15").style.display = "none";
    }
    else { // 1400
        if (isMobileDevice == "true") {
            document.getElementById("joinLauncherErrorDivMobile").style.display = "block";

            if (errorCode == serverBusyErrorCode) {
                document.getElementById("errorTextLabelMobile").innerHTML =
conferenceErrorServerBusy1;
                document.getElementById("checkUrlLabelMobile").innerHTML =
conferenceErrorServerBusy2;
            }
            else {
                document.getElementById("errorTextLabelMobile").innerHTML = conferenceError1;
                document.getElementById("checkUrlLabelMobile").innerHTML = conferenceError2;
            }

            document.getElementById("checkUrlLabelMobile").style.display = "block";
            document.getElementById("errorTextLabelMobile").style.display = "block";

            document.getElementById("diagLabelMobile").innerHTML = diag;

```

```

        document.getElementById("diagLabelMobile").style.display = "block";
        var diagInfoTextString = diagInfo.toString();
        document.getElementById("diagInfoTextMobile").value = diagInfoTextString;
        document.getElementById("diagInfoTextMobile").style.display = "none";
    }
    else { // non-mobile
        document.getElementById("joinLauncherErrorDiv").style.display = "block";

        if (errorCode == serverBusyErrorCode) {
            document.getElementById("errorTextLabel").innerHTML =
conferenceErrorServerBusy1;
            document.getElementById("checkUrlLabel").innerHTML =
conferenceErrorServerBusy2;
        }
        else {
            document.getElementById("errorTextLabel").innerHTML = conferenceError1;
            document.getElementById("checkUrlLabel").innerHTML = conferenceError2;
        }

        document.getElementById("errorTextLabel").style.display = "block";
        document.getElementById("checkUrlLabel").style.display = "block";

        document.getElementById("diagLabel").innerHTML = diag;
        document.getElementById("diagLabel").style.display = "block";
        var diagInfoTextString = diagInfo.toString();
        document.getElementById("diagInfoText").value = diagInfoTextString;
        document.getElementById("diagInfoText").style.display = "none";
    }
}
}

MainForm.prototype.DisplayInstalledClientLaunchedPage = function (launchedClient) {
    if (userExperience.toLowerCase() != defaultExperienceVersion) {

        // Show the Rich client launched text, etc.
        document.getElementById("launchRichClientDiv15").style.display = "block";

        // Tell Reach which client was launched so the Reach Landing
        // Page can be more intelligent about the links it displays
        // to the user.
        var fullReachURL = reachURL + "&launched=" + launchedClient;

        document.getElementById("JoinUsingLWAOptionHelp115").innerHTML =
txt_UnsupportedLyncVersion2;
        document.getElementById("JoinMeetingUsingLWA2_Link15").innerHTML =
txt_UnsupportedLyncVersion3;

        // Update the link for launching Reach.
        document.getElementById("JoinMeetingUsingLWA2_Link15").href = fullReachURL;
    }
    else {

        // Show the Rich client launched text, etc.
        document.getElementById("launchRichClientDiv").style.display = "block";

        // Show the Contact Support text with Reach option as well as the link to
        // launch Reach.
        document.getElementById("contactSupportLabelWithReachOption").style.display =
"block";
        document.getElementById("launchReachLink").style.display = "block";

        // Tell Reach which client was launched so the Reach Landing
        // Page can be more intelligent about the links it displays
        // to the user.
        var fullReachURL = reachURL + "&launched=" + launchedClient;

        // Update the link for launching Reach.
        document.getElementById("launchReachLink").href = fullReachURL;
    }
}

```

```

    // Hide the iFrame we use to launch Reach and expand it to 100%
    // so it occupies the entire area of the page.
    document.getElementById("launchReachDiv").style.display = "none";
    document.getElementById("launchReachFrame").style.width = "0px";
    document.getElementById("launchReachFrame").style.height = "0px";
    document.getElementById("launchReachFrame").style.display = "";
}

MainForm.prototype.RedirectToReach = function (url) {
    // Launch Reach from an iFrame, so that the
    // URL does not change in the Browser window.

    // Hide the main table that has all the page content.
    document.getElementById("mainTable").style.display = "none";
    document.getElementById("mainTable15").style.display = "none";
    document.getElementById("mainTablemobile").style.display = "none";

    // Un-hide the iFrame we use to launch Reach.
    document.getElementById("launchReachDiv").style.display = "block";
    document.getElementById("launchReachFrame").style.width = "100%";
    document.getElementById("launchReachFrame").style.height = "100%";
    document.getElementById("launchReachFrame").style.display = "block";

    // Hide the scrollbar for the main window, since the iFrame
    // will have its own scrollbar and that is the only one that
    // is relevant.
    window.document.body.style.overflow = "hidden";

    window.document.title = reachClientTitleString;

    // Launch Reach by updating the src of the iFrame.
    document.getElementById("launchReachFrame").src = url;
}

MainForm.prototype.ClosePage = function () {
    // Inspect browser version and take appropriate close action

    if (top == self) {
        if (isIE10TridentVersion() || isIE9TridentVersion() || isIE8TridentVersion() ||
isIE7()) {
            // set opener as self by invoking open - for IE7,IE8,IE9 & IE10 browsers
            window.open("", "_self");

            // close the browser window
            window.close();
        }
        else if (isIE6()) {
            // set the opener as self by directly setting the value of
            // self.opener - for IE6 browser only
            self.opener = this;

            // close the browser window
            window.close();
        }
    }
    else {
        if (isIE10TridentVersion() || isIE9TridentVersion() || isIE8TridentVersion() ||
isIE7() || isIE6()) {
            // set opener as self by invoking open - for IE7,IE8 and IE9 browsers
            top.window.opener = top;
            top.window.open("", "_parent");
            // close the browser window
            top.window.close();
        }
    }
}

MainForm.prototype.LanguageSelectionChanged = function () {

```

```

var languageSelector;

isMobileDevice = isMobile.toLowerCase();

if (userExperience.toLowerCase() != defaultExperienceVersion) {
    languageSelector = document.getElementById("languageSelectCmb15");
}
else {
    if (isMobileDevice == "true") {
        languageSelector = document.getElementById("languageSelectCmbMobile");
    }
    else {
        languageSelector = document.getElementById("languageSelectCmb");
    }
}

if (languageSelector.selectedIndex != -1) {
    var newLanguage = languageSelector.options[languageSelector.selectedIndex].value;
    if (newLanguage.toLowerCase() != currentLanguage.toLowerCase()) {
        this.UpdateSelectedLanguage(newLanguage);
        this.GetUpdatedResources(newLanguage);
        currentLanguage = newLanguage;
    }
}
}

MainForm.prototype.UpdateSelectedLanguage = function (language) {
    var languageSelector;

    isMobileDevice = isMobile.toLowerCase();
    if (userExperience.toLowerCase() != defaultExperienceVersion) {
        var languageSelector = document.getElementById("languageSelectCmb15");
    }
    else {
        if (isMobileDevice == "true") {
            languageSelector = document.getElementById("languageSelectCmbMobile");
        }
        else {
            var languageSelector = document.getElementById("languageSelectCmb");
        }
    }

    var index = -1;
    for (i = 0; i < languageSelector.options.length; i++) {
        if (languageSelector.options[i].value.toLowerCase() == language.toLowerCase()) {
            index = i;
            break;
        }
    }

    languageSelector.selectedIndex = index;
}

MainForm.prototype.GetUpdatedResources = function (language) {
    ResourceURL = resourceUrl.toLowerCase();
    var url = ResourceURL + language;
    var languageSelector;

    try {
        window.setTimeout(TimerHandler(this.connection, this.connection.SendHttpRequest,
"GET", url), 0);

        // Disable the language selector (so the user cannot keep changing
        // the language) until we receive the response with language resources
        // for the currently selected language.

        isMobileDevice = isMobile.toLowerCase();
        if (userExperience.toLowerCase() != defaultExperienceVersion) {
            languageSelector = document.getElementById("languageSelectCmb15");

```

```

    }
    else {
        if (isMobileDevice == "true") {
            languageSelector = document.getElementById("languageSelectCmbMobile");
        }
        else {
            languageSelector = document.getElementById("languageSelectCmb");
        }
    }
    languageSelector.disabled = true;
} catch (e) {
    // Ignore language related failures
}
}

MainForm.prototype.OnUpdatedResourcesCallback = function () {
    var XMLHTTPREQUEST_COMPLETE = 4;
    var XMLHTTPREQUEST_OK = 200;

    var currentState = null;
    var httpCode = null;

    try {
        currentState = this.connection._httpRequest.readyState;
    } catch (e) {
        // Ignore language related failures
        return;
    }

    try {
        // For Safari 10.1.3 the end status is 0
        if (currentState == 0 || currentState == XMLHTTPREQUEST_COMPLETE) {

            // Enable the language selector again.

            var languageSelector;

            isMobileDevice = isMobile.toLowerCase();
            if (userExperience.toLowerCase() != defaultExperienceVersion) {
                languageSelector = document.getElementById("languageSelectCmb15");
            }
            else {
                if (isMobileDevice == "true") {
                    languageSelector = document.getElementById("languageSelectCmbMobile");
                }
                else {
                    languageSelector = document.getElementById("languageSelectCmb");
                }
            }
            languageSelector.disabled = false;

            var httpCode = this.connection.httpRequest.status;

            if (httpCode == XMLHTTPREQUEST_OK) {
                // Get the text that the Server sent back
                // for the request we made.
                var text = this.connection.httpRequest.responseText;
                eval(text);

                this.UpdateUI();

                if (loading == "true") {
                    this.OnLoadComplete();
                }
            } else if (currentState != 0) {
                //Safari cannot get httpcode if network is down.

                // Ignore language related failures
            }
        }
    }
}

```

```

    }
  } catch (e) {
    // Ignore language related failures
  }
}

MainForm.prototype.UpdateUI = function () {

  isMobileDevice = isMobile.toLowerCase();

  if (textDirection) {
    window.document.dir = textDirection;
  }

  if (window.document.dir == "rtl") {
    document.getElementById("Img1").className = "bulletImageFlip";
    document.getElementById("Img3").className = "bulletimagemobileFlip";
    document.getElementById("Img4").className = "bulletImageErrorFlip";
    document.getElementById("Img6").className = "bulletImageErrorFlip";
  }
  else {
    document.getElementById("Img1").className = "bulletImage";
    document.getElementById("Img3").className = "bulletimagemobile";
    document.getElementById("Img4").className = "bulletImageError";
    document.getElementById("Img6").className = "bulletImageError";
  }

  if (userExperience.toLowerCase() != defaultExperienceVersion) {

    document.getElementById("mainTablemobile").style.display = "none";
    document.getElementById("mainTable").style.display = "none";
    document.getElementById("mainTable15").style.display = "block";
    document.getElementById("mainTable15").style.backgroundImage =
"url (/meet/Resources/Gradient.png)";

    if (screen.width >= 1280) {
      document.getElementById("content").className = "help1280";
    }

    if (isMobileDevice == "true") {

      document.getElementById("content").className = "helpMobile";
      document.getElementById("languageSettingsLabel15").style.display = "none";

      document.getElementById("languageSelectCmb15").style.width = "100px";
      document.getElementById("errorTextLabel15").className = "errorregularMobile";
      document.getElementById("checkUrlLabel15").className = "errorlowMobile";
      document.getElementById("errorHeader2").className = "errorHeader2Mobile";
      document.getElementById("diagLabel15").className = "bulletpointMobile";
      document.getElementById("errorBullet").className = "bulletImageErrorMobile";
      document.getElementById("errorBulletText").className = "bulletTextErrorMobile";
      document.getElementById("diagLabel215").className = "errorverylowMobile";
      document.getElementById("diagInfoText15").style.width = "60%";

      if (errorCode == "-1") {
        document.getElementById("copyright").innerText = txt_copyRightTextLabel15;
        document.getElementById("copyright").style.display = "block";
        document.getElementById("copyright").className = "copyrightMobile";

        document.getElementById("lynclogo").style.display = "block";
        document.getElementById("lynclogo").className = "logospaceMobile";
        document.getElementById("officeLogoColumn").className =
"officelogoColumnSuccessMobile";
        document.getElementById("contentRow15").className =
"contentClassSuccessMobile";
        document.getElementById("successLogoMobile").style.display = "block";
        //document.getElementById("spacer").className = "spacerSuccess";
        //document.getElementById("firstRow").className = "firstRowSuccess";
        document.getElementById("officeImageSuccess").style.display = "none";
      }
    }
  }
}

```

```

        document.getElementById("officeImageError").style.display = "none";
        document.getElementById("footer").className = "footerSuccessMobile";
        document.getElementById("errorLogoMobile").style.display = "none";
    }
    else {
        document.getElementById("lynclogo").style.display = "none";
        document.getElementById("officeLogoColumn").className =
"officelogoColumnErrorMobile";
        document.getElementById("contentRow15").className =
"contentClassErrorMobile";
        document.getElementById("errorLogoMobile").style.display = "block";
        //document.getElementById("spacer").className = "spacerError";
        //document.getElementById("firstRow").className = "firstRowError";
        document.getElementById("officeImageError").style.display = "block";
        document.getElementById("officeImageError").className = "officeImageMobile";
        document.getElementById("officeImageSuccess").style.display = "none";
        document.getElementById("footer").className = "footerErrorMobile";
    }
}
else {
    if (errorCode == "-1") {
        document.getElementById("lynclogo").style.display = "block";
        document.getElementById("officeLogoColumn").className =
"officelogoColumnSuccess";
        document.getElementById("contentRow15").className = "contentClassSuccess";
        document.getElementById("successLogo").style.display = "block";
        //document.getElementById("spacer").className = "spacerSuccess";
        document.getElementById("firstRow").className = "firstRowSuccess";
        document.getElementById("officeImageSuccess").style.display = "block";
        document.getElementById("footer").className = "footerSuccess";
        document.getElementById("copyright").style.display = "block";
        document.getElementById("copyright").innerText = txt_copyRightTextLabel15;
        document.getElementById("errorLogo").style.display = "none";
        document.getElementById("officeImageError").style.display = "none";
    }
    else {
        document.getElementById("lynclogo").style.display = "none";
        document.getElementById("officeLogoColumn").className =
"officelogoColumnError";
        document.getElementById("contentRow15").className = "contentClassError";
        document.getElementById("errorLogo").style.display = "block";
        //document.getElementById("spacer").className = "spacerError";
        document.getElementById("firstRow").className = "firstRowError";
        document.getElementById("officeImageError").style.display = "block";
        document.getElementById("footer").className = "footerError";
        document.getElementById("copyright").style.display = "none";
    }
}

    document.getElementById("languageSettingsLabel15").innerHTML =
txt_languageSettingsLabel;
    document.getElementById("launchRichClientHeaderLabel15").innerHTML =
txt_launchRichClientHeaderLabel;
    document.getElementById("launchRichClientTextLabel15").innerHTML =
txt_launchRichClientTextLabel;
    document.getElementById("contactSupportLabelWithReachOption").innerHTML =
txt_unableToJoinLabel;
    document.getElementById("JoinUsingLWAOptionHelp115").innerHTML =
txt_UnsupportedLyncVersion2;
    document.getElementById("JoinMeetingUsingLWA2 Link15").innerHTML =
txt_UnsupportedLyncVersion3;

    var launchReachText = txt_joinUsingReachLink.replace(/%0/g, reachClientProductName);
    document.getElementById("launchReachLink").innerHTML = launchReachText;
    document.getElementById("launchReachLink").title = launchReachText;

```



```

document.getElementById("errorTextLabel15").innerHTML = conferenceError1;
document.getElementById("checkUrlLabel15").innerHTML = conferenceError2;
document.getElementById("diagLabel15").innerHTML = diag;

var diagInfoTextString = diagInfo.toString();
document.getElementById("diagInfoText15").value = diagInfoTextString;
document.getElementById("diagInfoText15").style.display = "none";
document.getElementById("diagLabel215").style.display = "none";
document.getElementById("diagLabel215").innerHTML = diag2;

document.getElementById("onlineHelpLink").innerHTML = txt_onlineHelpLink;
document.getElementById("onlineHelpLink").title = txt_onlineHelpLink;
document.getElementById("helpImage15").title = txt_onlineHelpLink;
//document.getElementById("copyRightTextLabel15").innerHTML =
txt_copyRightTextLabel15;

document.getElementById("UnsupportedClientBlockMessageLabel15").innerHTML =
txt_UnsupportedLyncVersion1;
document.getElementById("JoinUsingLWAOption115").innerHTML =
txt_UnsupportedLyncVersion2;
document.getElementById("JoinMeetingUsingLWA_Link15").innerHTML =
txt_UnsupportedLyncVersion3;

document.getElementById("connectingLabel15").innerHTML = txt_connecting;
document.getElementById("mobileappstoreLabel15").innerHTML =
txt_unableToLaunchLyncMobile;
document.getElementById("mobileappstoreLabel215").innerHTML =
txt_unableToLaunchLyncMobile2;
document.getElementById("mobileappstoreLabel315").innerHTML =
txt_unableToLaunchLyncMobile3;
document.getElementById("unknownMobileDeviceLabel15").innerHTML =
txt_unsupportedMobileDevice;
}
else {

if (isMobileDevice == "true") {
document.getElementById("mainTable").style.display = "none";
document.getElementById("mainTable15").style.display = "none";
document.getElementById("mainTablemobile").style.display = "block";

document.getElementById("languageSettingsLabelMobile").innerHTML =
txt_languageSettingsLabel;

document.getElementById("errorTextLabelMobile").innerHTML = conferenceError1;
document.getElementById("checkUrlLabelMobile").innerHTML = conferenceError2;
document.getElementById("diagLabelMobile").innerHTML = diag;

var diagInfoTextString = diagInfo.toString();
document.getElementById("diagInfoTextMobile").value = diagInfoTextString;
document.getElementById("diagInfoTextMobile").style.display = "none";
document.getElementById("diagLabel2Mobile").style.display = "none";
document.getElementById("diagLabel2Mobile").innerHTML = diag2;

document.getElementById("onlineHelpLinkMobile").innerHTML = txt_onlineHelpLink;
document.getElementById("copyRightTextLabelMobile").innerHTML =
txt_copyRightTextLabel;

document.getElementById("connectingLabel").innerHTML = txt_connecting;
document.getElementById("mobileappstoreLabel").innerHTML =
txt_unableToLaunchLyncMobile;
document.getElementById("mobileappstoreLabel2").innerHTML =
txt_unableToLaunchLyncMobile2;
document.getElementById("unknownMobileDeviceLabel").innerHTML =
txt_unsupportedMobileDevice;
return;
}

// non-mobile

```

```

        document.getElementById("mainTable15").style.display = "none";
        document.getElementById("mainTablemobile").style.display = "none";
        document.getElementById("mainTable").style.display = "block";

        document.getElementById("languageSettingsLabel").innerHTML =
txt languageSettingsLabel;
        document.getElementById("launchRichClientHeaderLabel").innerHTML =
txt_launchRichClientHeaderLabel;
        document.getElementById("launchRichClientTextLabel").innerHTML =
txt_launchRichClientTextLabel;
        document.getElementById("contactSupportLabelWithReachOption").innerHTML =
txt_unableToJoinLabel;

        var launchReachText = txt_joinUsingReachLink.replace(/%0/g, reachClientProductName);
        document.getElementById("launchReachLink").innerHTML = launchReachText;
        document.getElementById("launchReachLink").title = launchReachText;

        document.getElementById("errorTextLabel").innerHTML = conferenceError1;
        document.getElementById("checkUrlLabel").innerHTML = conferenceError2;
        document.getElementById("diagLabel").innerHTML = diag;

        var diagInfoTextString = diagInfo.toString();
        document.getElementById("diagInfoText").value = diagInfoTextString;
        document.getElementById("diagInfoText").style.display = "none";
        document.getElementById("diagLabel2").style.display = "none";
        document.getElementById("diagLabel2").innerHTML = diag2;

        document.getElementById("onlineHelpLink").innerHTML = txt_onlineHelpLink;
        document.getElementById("copyRightTextLabel").innerHTML = txt copyRightTextLabel;

        document.getElementById("64bitUnSupportedMessage").innerHTML =
txt_64bitUnSupportedText1;
        document.getElementById("64bitUnSupportedOption1").innerHTML =
txt 64bitUnSupportedOption1;
        document.getElementById("JoinMeetingUsingLync_Link").innerHTML =
txt 64bitJoinUsingLync;
        document.getElementById("64bitUnSupportedOption2").innerHTML =
txt_64bitUnSupportedOption2;
        document.getElementById("64bitUnSupportedMessageLabel").innerHTML =
txt 64bitbrowserUnSupportedLabel;

        document.getElementById("UnsupportedClientBlockMessageLabel").innerHTML =
txt_UnsupportedLyncVersion1;
        document.getElementById("JoinUsingLWAOption1").innerHTML =
txt_UnsupportedLyncVersion2;
        document.getElementById("JoinMeetingUsingLWA Link").innerHTML =
txt_UnsupportedLyncVersion3;
    }
}

//
// Connection object - BEGIN
//
function ConnectionObject()
{
    // Properties of the object
    this.httpRequest = this.CreateXMLHttpRequestObject( );
}

ConnectionObject.prototype._CreateXMLHttpRequestObject = function()
{
    var httpRequest = null;

    try
    {
        if( window.XMLHttpRequest ) // for none IE browsers
        {
            httpRequest = new XMLHttpRequest();
        }
    }
}

```

```

else if( window.ActiveXObject ) // for IE
{
    var MSXML_XMLHTTP_PROGIDS = new Array(
        'Microsoft.XMLHTTP',
        'MSXML2.XMLHTTP.5.0',
        'MSXML2.XMLHTTP.4.0',
        'MSXML2.XMLHTTP.3.0',
        'MSXML2.XMLHTTP'
    );

    for (var i=0; i < MSXML_XMLHTTP_PROGIDS.length; i++)
    {
        httpRequest = new ActiveXObject(MSXML_XMLHTTP_PROGIDS[i]);

        if( httpRequest != null )
        {
            break;
        }
    }
} catch (e) {
    // Ignore any exception since
    // we are just initializing.
}

return httpRequest;
}

ConnectionObject.prototype.SendHttpRequest = function(type, url) {
    try {
        // Set up a new request to the Server.
        // Request is async.
        this._httpRequest.open(type, url, true);

        this._httpRequest.onreadystatechange = Delegate(mainWindow,
mainWindow.OnUpdatedResourcesCallback);

        // Send the request to the Server.
        // No data to send, so pass null.
        this._httpRequest.send(null);
    } catch (e) {
        // Ignore language related failures
    }
}
//
// Connection object - END

```



3 Protocol Details

3.1 Conference Activation and Deactivation Details

Activation refers to the act of instantiating a **conference**. Deactivation refers to the act of closing a particular instance of the conference. The **focus** controls activation and deactivation of conferences based on participants joining and leaving the conference.

The trigger for the activation depends upon the focus implementation. The trigger for deactivation depends upon the focus implementation, but can happen after the last user leaves the conference.

3.1.1 Abstract Data Model

This section describes a conceptual model of possible data organization that an implementation maintains to participate in this protocol. The described organization is provided to facilitate the explanation of how the protocol behaves. This document does not mandate that implementations adhere to this model as long as their external behavior is consistent with what is described in this document.

Recommendations for the implementer:

- The **focus** maintains a table of participants connected to it per **conference**.
- The focus maintains a table of participants connected to each **MCU** per conference.
- The focus maintains a table of **entity-view** elements for each MCU that contains all of the **entity-view** subelements per conference.
- The focus maintains an **MCU-Conference-URI** table that is keyed by **MCU-Type**, and stores the MCU-Conference-URI for each MCU per conference.

Note that the preceding conceptual data model can be implemented using a variety of techniques. An implementation is at liberty to implement the data model in any way that is convenient.

3.1.2 Timers

None.

3.1.3 Initialization

None.

3.1.4 Higher-Layer Triggered Events

This section specifies the higher-layer triggered events for conference activation and deactivation.

3.1.4.1 Activating a Conference

During **conference** activation, the **focus** performs the initial initialization for each conference.

The focus first enumerates all of the **MCU** types requested by the **organizer** for the conference and then bootstraps an MCU for each requested **MCU-Type**. The actual bootstrap protocol is outside the scope of this specification, but it includes sending policy and initial setting information specified by the organizer to the MCU.

The conference MUST be activated, even if one or more MCUs fail to bootstrap. The focus can retry failed MCU bootstraps during the lifetime of the conference or use any resource management algorithm to manage MCUs.

3.1.4.1.1 Obtaining MCU-Conference-URIs

For each **MCU-Type**, the **focus** obtains a **SIP URI**, the **MCU-Conference-URI**, and populates the MCU-Conference-URI table with it. The actual mechanism to obtain this URI is implementation-dependent, so is not specified here.

The MCU-Conference-URI MUST satisfy the following two requirements:

- **INVITE** requests targeted to this MCU-Conference-URI MUST be routable to the **MCU**.
- The MCU MUST be able to identify the conference in its local state from the MCU-Conference-URI.

3.1.4.2 Deactivating a Conference

Deactivation removes an instance of the **conference** at the **focus**, along with all associated instance-specific information. This can happen manually or automatically. The first occurrence of any manual or automatic scenario deactivates the conference.

The actual trigger for deactivation is outside the scope of this specification. Following are some examples of triggers.

- The presenter sends a **deleteConference** command to the focus.
- The **organizer** sends a **deleteConference** command to the **Focus Factory**.
- The organizer leaves the company.
- The conference is inactive.

In all of these cases, the deactivation protocol follows the procedures specified for the **deleteConference** command defined in section [4.4.4](#).

3.1.5 Message Processing Events and Sequencing Rules

None.

3.1.6 Timer Events

None.

3.1.7 Other Local Events

None.

3.2 Joining and Leaving a Conference Details

Simple Join

Simple join describes the mechanism for joining a native client application to a conference in one click. Simple join requires that the native client application is installed on the user's computer along with the simple join web plugin. Simple join is facilitated by the simple join web application. When a user clicks on a simple join hyperlink, the web application is invoked. The simple join web application constructs an XML document with the conference details, called the ocsmeet document, which is then passed to

the browser plugin via script. The browser plugin is then responsible for launching the native client application and supplying it with the conference details contained in the ocsmeet document.

The content body of the ocsmeet document SHOULD<39> conform to the format defined in section 6.1. It contains all the information that a client application needs to join a conference. It is returned by the join web application server in the response to a request made to the join web application when a user clicks the simple join hyperlink. After obtaining the ocsmeet document, the simple join web application then loads the browser plugin and runs a version check on the plugin. If the plugin passes the version check, the join web application will transfer the ocsmeet document to the plugin via script. Using the ocsmeet document, the plugin will then create a file in a temporary folder on the user's computer with the extension .ocsmeet and with the ocsmeet document as the file content. The host operating system is then invoked to open the new file. The native client application, which has to register with the host operating system to handle files with the extension .ocsmeet for simple join to work, is then launched by the operating system. Using the information in the file, the native application then joins the conference. The call flow for simple join is shown in the following figure.

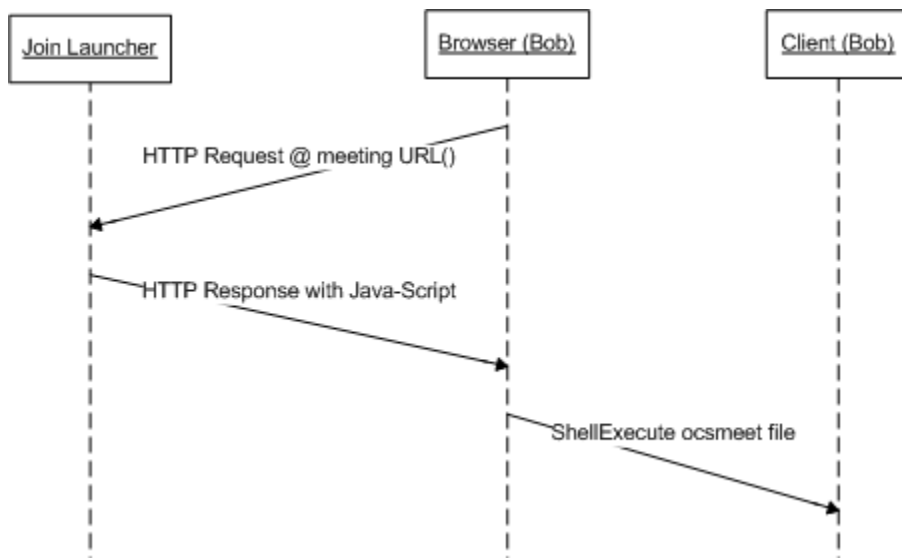

Figure 3: Simple Join

Joining and Leaving a Conference

The conceptual model of joining and leaving a **conference** is similar to that described in [RFC4353] section 4.1. One exception to the conceptual model in [RFC4353] section 4.1 is that the focus does support sending an invite requests to participants, but participants will need to join the focus by sending an invite to the focus.

A participant joins a conference by establishing a signaling **dialog** with the **focus**. This is done by sending an **INVITE** request to the focus with an **addUser** body, as shown in the following figure.

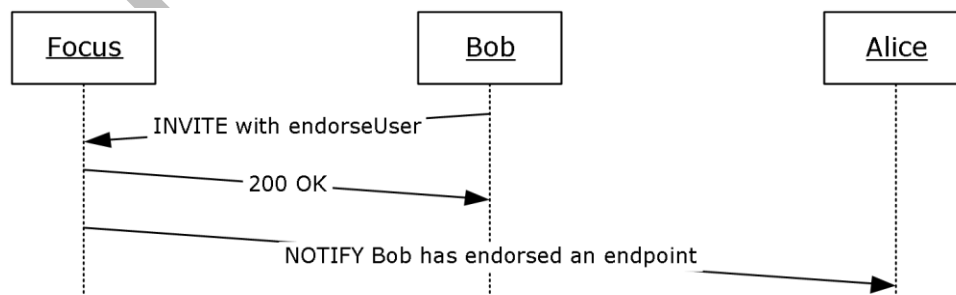

Figure 4: Joining a conference

A participant leaves the conference by terminating the signaling dialog with the focus, as shown in the following figure.

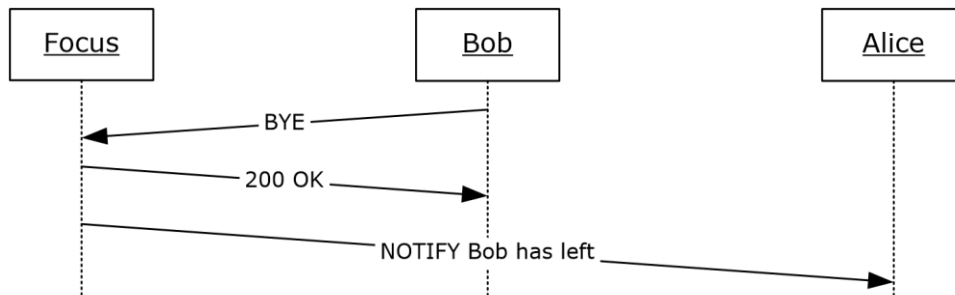

Figure 5: Leaving a conference

3.2.1 Abstract Data Model

None.

3.2.2 Timers

There are no additional timers required beyond what is specified in [\[RFC3261\]](#), [\[RFC4028\]](#), and [\[MS-CONMGMT\]](#).

3.2.3 Initialization

None.

3.2.4 Higher-Layer Triggered Events

3.2.4.1 Client Role

A participant joins a **conference** by establishing a signaling **dialog** with the **focus**. This is done by sending an **INVITE** request to the focus. A participant can subsequently send re-INVITE requests to the focus with the same message body that it used for the original INVITE.

If the client decides to cancel a join request while the INVITE has not received its **final response**, it can send a CANCEL request to the focus.

A participant leaves a conference by terminating the signaling dialog with the focus. The participant uses a **SIP BYE** request for this purpose.

The SIP UPDATE request is used with a session timer, as specified in [\[RFC4028\]](#) section 7.1, to refresh the dialog state.

Except as specified in the following sections, the message processing rules follow [\[RFC3261\]](#) section 8.2.5 and [\[RFC4028\]](#) section 8.

A client needs to rely on the focus **endpoint** element state to decide whether it has been placed in the conference **lobby** or not, as specified in section [3.4](#).

3.2.4.1.1 Constructing the SIP INVITE Request

The **INVITE** request SHOULD be constructed using the message syntax rules specified in section [2.2.1](#). It MUST be populated with a valid **addUser** request body, in accordance with the **addUser** request syntax defined in section [2.2.3.3](#).

If the user is joining on behalf of another user, the client MUST add a **p-session-on-behalf-of SIP** header as defined in [\[MS-SIPAE\]](#). The client SHOULD [<40>](#) also add a **session-on-behalf-of** element to the **addUser** request body, as specified in section 2.2.3.3, with the value of the **p-session-on-behalf-of** SIP header.

A client that enables its users to manage the **lobby** sets the **lobby-capable** element within the **addUser** body to "true".

```
<addUser>
  <conferenceKeys
    confEntity="sip:alice@fabrikam.com;gruu;opaque=app:conf:focus:id:MH22CRI4" />
  <user
    entity="sip:alice@fabrikam.com" xmlns="urn:ietf:params:xml:ns:conference-info">
    <display-text>Alice</display-text>
    <roles>
      <entry>attendee</entry>
    </roles>
    <endpoint
      entity="{ac53488e-4c53-4b6f-a6e1-1b862a16e378}"
      msci:endpoint-
uri="sip:alice@fabrikam.com;opaque=user:epid:AbFhptOVHFeNUhhq bZ QQAA;gruu">
      <joining-method>dialled-in</joining-method>
      <msci:clientInfo>
        <separator xmlns="urn:ietf:params:xml:ns:conference-info-separator" />
        <lobby-capable
xmlns="http://schemas.microsoft.com/rtc/2008/12/confinfoextensions">true</lobby-capable>
      </msci:clientInfo>
    </endpoint>
  </user>
</addUser>
```

3.2.4.1.2 Joining conference as anonymous user

The mechanism for joining as an anonymous user is described in [\[MS-SIPAE\]](#) section 3.2.4.3. Once an anonymous user has joined a conference, conference control is the same as for authenticated users, as specified in this protocol.

3.2.4.2 Focus Role

When the **focus** receives an **INVITE** request targeted to a **conference**, it SHOULD authorize the request and admit the user into the conference. If the user is not authorized to join the conference, the focus MUST respond with a **403 Forbidden** response. If the user is admitted, the focus SHOULD respond with a **200 OK** response to the INVITE and then establish a **dialog**.

If a **session-on-behalf-of** element is present in the **addUser** request body, the focus MUST validate that a **p-session-on-behalf-of SIP** header is present as well, and that their values are equal.

If the validation fails, the focus SHOULD [<41>](#) respond with a 403 Forbidden response.

If the focus receives a CANCEL request when the INVITE has not received its **final response**, it SHOULD treat the CANCEL request as a participant leave event.

If the focus receives a BYE request for an existing dialog, it SHOULD treat the request as a participant leave event.

If the focus decides to end the conference, it SHOULD eject all of the participants in the conference. In such a scenario, the focus SHOULD send a BYE to each participant, thereby terminating the signaling dialog.

If the focus receives a SIP UPDATE request, it SHOULD extend the dialog lifetime using the procedures described in [\[RFC4028\]](#) section 9. It MAY also accept re-INVITE requests and extend the dialog lifetime by some predetermined value. It is recommended that a value of 600 seconds be used for this purpose.

When a participant is accepted, the focus MUST send a **notification** to other participants who have subscribed to receive conference notifications. This functionality is similar to the conference notification service defined in [\[RFC4353\]](#) section 4.4, and is specified in section [3.4](#).

Except as specified in the following sections, the message processing rules follow the specifications in [\[RFC3261\]](#) section 8 and [\[RFC4028\]](#) section 8.2.5.

3.2.4.2.1 Processing the addUser request

The **focus** SHOULD first parse the **addUser** request body and apply the basic syntax validation rules given in section [2.2.3.3](#).

Detailed signaling **dialog** establishment examples are given in section [4](#).

3.2.4.2.2 Processing INVITE from anonymous client

When the **focus** receives a **conference** join **INVITE** from an anonymous user, it MUST process it according to rules described in [\[MS-SIPAE\]](#) section 3.3.5.4. For an example, see [\[MS-SIPAE\]](#) section 4.5.

3.2.5 Message Processing Events and Sequencing Rules

Except as specified in the following subsections, the rules for message processing are as specified in [\[RFC3261\]](#) section 8, [\[RFC4028\]](#) section 8.2.5, and [\[MS-CONMGMT\]](#) section 3.

3.2.5.1 Client Role

The **UAC** SHOULD parse the body of the **200 OK** response, extract the role returned by the **focus**, and use it as the role for the rest of the **conference**.

3.2.5.2 Focus Role

This section specifies the message processing events and sequencing rules for the **focus** role in joining a **conference** and leaving a conference.

3.2.5.2.1 Constructing the SIP INVITE Response

If the **focus** decides to accept the participant into the **conference**, it MUST generate and send a **200 OK INVITE** response constructed using the message syntax rules specified in section [2.2.1](#).

The INVITE response is used to indicate the success or failure of the INVITE request. It conforms to the SIP message formats specified in [\[RFC3261\]](#) section 7.2. The focus receiving the INVITE request and generating the response behaves as a **user agent server (UAS)**, as defined in [\[RFC3261\]](#) section 6.

The **Session-Expires** header SHOULD be present in a response if the corresponding request indicated support for session timers by the presence of a **Supported** header field with the option tag **timer**. In such a case, the **Session-Expires** header value is computed as specified in [\[RFC4028\]](#) section 4, with the exception that the refresher parameter MUST be set to "uac". In addition, such a response MUST

include a **Supported** header field with the option tag **timer**, as well as a **Require** header field with the option tag **timer**.

The response MUST be populated with a valid **addUser** response body in accordance with the general body format rules given in section [2.2.3.4](#).

3.2.5.2.2 Multiple Endpoints Connecting to the Focus

The **focus** SHOULD allow multiple **endpoints** of the same participant to connect to the **conference**.

If the focus allows multiple endpoints of the same participant to connect to the conference, all such connected **endpoints** MUST be listed inside the **user** element of the conference roster for that user. The **user** element is defined in section [2.2.4.2](#).

The focus MUST manage each endpoint independent of the others. When one endpoint terminates the **dialog** with the focus, it MUST NOT affect other endpoints connected to the focus.

3.2.5.2.3 Notifying Watchers When a Participant Joins

When a participant joins, all other participants in a **conference** MUST be notified of the participant connected event using the procedures described in section [3.4](#).

The generated document MUST conform to the syntax rules given in section [2.2.4](#).

3.2.5.2.4 SIP Error Response Codes

The following table specifies the extension **SIP response** codes that are defined by this specification.

| SIP response code | Reason |
|-------------------|--|
| 400 | Malformed request with one or more invalid headers or invalid content-body. |
| 403 | Forbidden: User is not authorized to join the conference, as defined by conference policy. |
| 404 | Failure: Conference Not Found. |
| 603 | Failure: Meeting size has been exceeded and no more participants are allowed. |

3.2.6 Timer Events

None.

3.2.7 Other Local Events

None.

3.3 Endorsing a Participant in a Conference Details

When one participant endorses another participant, the **focus** records an association between the endorsing participant and the endorsed participant within the context of a specific conference. The endorsing participant MUST present the call identifier, local tag, and remote tag of the **dialog** between the endpoint of the endorsed participant and the focus. These values constitute a shared secret which, when presented through the dialog between the endorsing participant's endpoint and the focus,

asserts that the endorsing participant's endpoint and the endorsed participant's endpoint exist within the same trusted context (such as when both endpoints run on the same computing device).

The relationship between the endorsing participant and the endorsed participant includes the following details:

- If the endorsed participant does not have the role of presenter in the conference, its role **MUST** be promoted to presenter if the policies for the conference grant the endorsing participant the role of presenter.
- If the endorsed participant is restricted to the conference lobby, it **MUST** be granted full access to the conference if the policies for the conference grant the endorsing participant full access to the conference.
- The conference roster entry for the endorsed participant will indicate the URI and display text of the participant that last endorsed it, using the syntax defined in section [2.2.4.2](#).

A participant endorses another participant in a conference by establishing a signaling dialog with the focus. This is done by sending an **INVITE** request to the focus with an **endorseUser** body, as shown in the following figure.

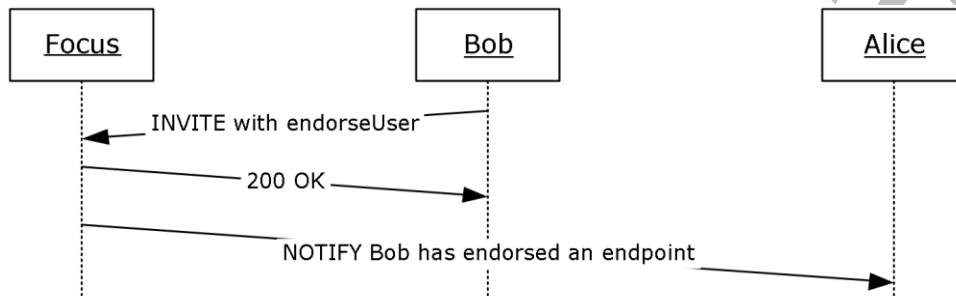

Figure 6: Endorsing an endpoint in a conference

3.3.1 Abstract Data Model

None.

3.3.2 Timers

There are no additional timers required beyond what are specified in [\[RFC3261\]](#), [\[RFC4028\]](#), and [\[MS-CONMGMT\]](#).

3.3.3 Initialization

None.

3.3.4 Higher-Layer Triggered Events

3.3.4.1 Client Role

An endpoint endorses another endpoint in a **conference** by establishing a signaling **dialog** with the **focus**. This is done by sending an **INVITE** request to the focus.

If the client decides to cancel an endorsement request while the INVITE has not received its **final response**, it can send a CANCEL request to the focus.

After the INVITE has received its final response, the dialog between the endorsing endpoint and the focus SHOULD be terminated.

Except as specified in the following sections, the message processing rules follow [\[RFC3261\]](#) section 8.2.5 and [\[RFC4028\]](#) section 8.

3.3.4.2 Focus Role

When the **focus** receives an **INVITE** request with an **endorseUser** body targeted to a **conference**, it SHOULD authorize the request and perform the corresponding changes in conference state for the endorsed participant, as defined in section [3.3](#). If the user is not authorized to endorse a participant in the conference, the focus MUST respond with a **401 Unauthorized** response. If the **endorseUser** request completes successfully, the focus SHOULD respond with a **200 OK** response to the INVITE and then terminate the **dialog**. Client implementations SHOULD NOT send a BYE to terminate an endorse user invite dialog. If the focus receives a CANCEL request while the INVITE has not received its **final response**, it MUST cancel the endorsement operation.

The protocol server SHOULD reject an **endorseUser** request for any of the following reasons:

- Administrative policies prevent the participant associated with the endorsed endpoint from being endorsed by another endpoint.
- Administrative policies prevent the participant associated with the endorsing endpoint from endorsing another endpoint.

In these cases, the server will respond to the **endorseUser** request with 401 Unauthorized.

3.3.4.2.1 Processing the endorseUser request

The **focus** SHOULD first parse the **endorseUser** request body and apply the basic syntax validation rules specified in section [2.2.3.3](#).

Detailed signaling **dialog** establishment examples are described in section [4](#).

3.3.5 Message Processing Events and Sequencing Rules

Except as specified in the following subsections, the rules for message processing are as specified in [\[RFC3261\]](#) section 8, [\[RFC4028\]](#) section 8.2.5, and [\[MS-CONMGMT\]](#) section 3.

3.3.5.1 Client Role

None.

3.3.5.2 Focus Role

This section specifies the message processing events and sequencing rules for the **focus** role in endorsing an endpoint in a **conference**.

3.3.5.2.1 SIP Error Response Codes

The following table specifies the extension **SIP response** codes that are defined by this specification.

| SIP response code | Reason |
|-------------------|---|
| 400 | Malformed request with one or more invalid headers or invalid content-body. |

| SIP response code | Reason |
|-------------------|--|
| 401 | Unauthorized: User is not authorized to endorse another endpoint in the conference, as defined by conference policy. |
| 404 | Failure: Conference not found. |

3.3.6 Timer Events

None.

3.3.7 Other Local Events

None.

3.4 Conference Subscriptions and Notifications Details

Participants in a **conference** can subscribe to the **focus** to receive conference state change **notifications** using the procedures specified in [\[RFC4575\]](#). Basic call flow for the subscription is shown in the following figure.

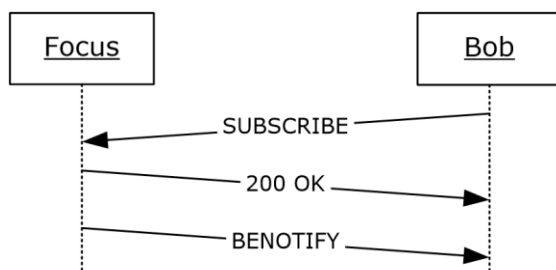

Figure 7: Subscribing to a conference

The **200 OK** contains the client **focus endpoint** details that determine if the client was directly admitted into the conference or placed in the conference **lobby**. A "connected" **endpoint** state determines that the client is connected to the conference.

Following is an example of a connected state.

```

<user entity="sip:bob@fabrikam.com" state="full">
  <display-text>Bob</display-text>
  <roles>
    <entry>attendee</entry>
  </roles>
  <endpoint entity="{659dae6c-82aa-46c8-8b37-da684a1a0d06}"
    session-type="focus" epid="732A323248" endpoint-
    uri="sip:bob@fabrikam.com;opaque=user:epid:vAaOGYq2H12kV5u7RWPdEQAA;gruu">
    <status>connected</status>
  </endpoint>
</user>
  
```

Following is an example of an "on-hold" state that indicates that a client has been placed in the lobby.

```

<user entity="sip:bob@fabrikam.com" state="full">
  
```

```

<display-text>Bob</display-text>
<roles>
<entry>attende</entry>
</roles>
<endpoint entity="{659dae6c-82aa-46c8-8b37-da684a1a0d06}"
  session-type="focus" epid="732A323248" endpoint-
  uri="sip:bob@fabrikam.com;opaque=user:epid:vAaOGYq2H12kV5u7RWPdEQAA;gruu">
<status>on-hold</status>
</endpoint>
</user>

```

Clients MAY populate the **ms-telemetry-id** header on conference subscribe requests with an identifier that the server can then use to report telemetry data for that subscription request.

The basic call flow for subscription termination is shown in the following figure. In this figure, the Client "Bob" sends a **SUBSCRIBE** request with an **Expires: 0** header, as specified in [\[RFC3265\]](#) section 3.1.1, to terminate the subscription **dialog**.



Figure 8: Terminating a subscription

3.4.1 Abstract Data Model

This section describes a conceptual model of possible data organization that an implementation maintains to participate in this protocol. The described organization is provided to facilitate the explanation of how the protocol behaves. This document does not mandate that implementations adhere to this model as long as their external behavior is consistent with what is described in this document.

3.4.1.1 Client Role

Recommendations for implementer are as follows:

- The client maintains an internal table that is keyed by the various elements and attributes of the conference data model and stores the corresponding value obtained from the conference **notifications**.
- The client maintains a static list of **MCU-Types** that it recognizes and supports.
- The client maintains a table, called the **MCU-Conference-URI** table, which is keyed by the **MCU-Type** and stores the MCU-Conference-URI for each **MCU**.

Note that this conceptual data model can be implemented using a variety of techniques. An implementation is at liberty to implement the data model in any way that is convenient.

3.4.2 Timers

3.4.2.1 Client Role

When a subscription **dialog** is established, the client can start an internal timer set to a value of 32 seconds for receiving the first full **notification**.

Other timers are specified in [\[RFC3265\]](#) section 3.1.6.1.

3.4.3 Initialization

3.4.3.1 Client Role

Before establishing a subscription with the **focus**, the client MUST have joined the **conference** by establishing a valid signaling **dialog** with the focus, as specified in section [3.2](#). This is an extension to the specifications in [\[RFC4575\]](#) section 5.

The client can indicate support for the **ms-benotify** or **ms-piggyback-first-notify** extensions specified in [\[MS-SIP\]](#) section [3.4](#). If it indicates support for them, it SHOULD be prepared to accept responses and **notifications** conforming to those extensions, as specified in [\[MS-SIP\]](#) section [3.4.5.1](#).

Detailed subscription establishment examples are given in section [4](#).

3.4.4 Higher-Layer Triggered Events

3.4.4.1 Client Role

The message processing rules follow the specifications in [\[RFC3265\]](#) section 3.2.4 and [\[RFC4575\]](#) section 3.7.

After a subscription **dialog** is established between the subscriber and the **focus**, the standard rules specified in [\[RFC3265\]](#) MUST be followed for dialog extension, dialog termination, and notify generation.

A client placed in the **lobby** receives limited data in the **notification**. When admitted into the **conference**, it receives a full notification.

A client in the lobby does not receive any data about other lobby or admitted clients, the current conference state while in the lobby, or the **MCUs** that have been activated for the conference.

A client in the lobby SHOULD check the **lobby-capable** element in the limited notification it receives. If the **lobby-capable** element is present and set to "true", the client can wait to be admitted to the conference. [<42>](#) If the **lobby-capable** element is absent or is set to "false", the client SHOULD immediately terminate its focus and subscription dialogs with the conference.

3.4.4.2 Focus Role

The **focus** behaves as a conference notification service, as specified in [\[RFC4353\]](#) section 4.4, and implements the **conference event package** specified in [\[RFC4575\]](#) section 5.

The focus SHOULD also behave as a subscriber to each **MCU** in the conference. If it does so, it SHOULD maintain a local copy of the MCU conference state received from the MCU. It SHOULD compose the conference document by aggregating the conference state maintained locally with the conference state received from all MCUs using the roster aggregation algorithm defined in section [3.4.4.2.1](#). This algorithm is given as an example of how implementations can aggregate the

conference roster. Implementations can choose any mechanism as long as the external behavior is conformant.

When a participant is admitted into the conference, the focus MUST send that participant a **notification** setting that sets the state of the **endpoint** of the participant to "connected".

The focus MUST send a full notification to a **lobby** participant that has been admitted into the conference.

The focus SHOULD NOT send information about other participants in a conference to a participant in the lobby.

The **conference-info** document generated by the focus and sent to watchers MUST conform to the conference roster document format, as specified in section [2.2.4](#).

The **conference-info** document MUST NOT contain any information that needs to be encrypted when sent back to the client. The data that need to be encrypted are the external web URL, the internal web URL, and the conference key. For retrieving sensitive information in encrypted form, the client MUST use the **getConference** control command, as specified in section [3.12](#).

The focus SHOULD reject a subscription from a participant that does not have an existing signaling **dialog**. The lifetime of the subscription dialog SHOULD be scoped to the signaling dialog. Thus, if the signaling dialog terminates for some reason, the focus SHOULD automatically terminate the subscription dialog if one exists, even if the subscriber does not explicitly request its termination. Standard subscription termination procedures specified in [\[RFC3265\]](#) 3.1.1 MUST be followed.

After a subscription dialog is established between the subscriber and the focus, the standard rules specified in [\[RFC3265\]](#) section 3.1.1 and [\[MS-SIP\]](#) sections 3.3 and 3.5 MUST be followed for dialog extension, dialog termination, and notify generation.

Detailed subscription establishment examples are given in section [4](#).

3.4.4.2.1 Roster Aggregation Algorithm

Using [\[RFC4575\]](#) terminology, the **focus** acts as the subscriber for the **conference** state events published by the **MCUs**, independent of whether the MCUs are collocated or located separately. The focus thus receives independent state events from each MCU participating in a conference. The focus also maintains local conference state such as conference metadata and participant state. Because the conference roster is logically distributed across multiple MCUs and the focus, it becomes necessary to aggregate all the fragments to produce a consistent view of the conference roster.

This section provides a description of the basic aggregation logic that MUST be supported by all focus implementations that expose multiple MCU support to the client. The aggregation algorithm described later in this section requires the following focus behavior:

- The focus supports multiple MCUs in a conference, which are capable of reporting conference state independently.
- Only one **endpoint** is supported per MCU per user. Thus, an MCU SHOULD NOT allow more than one endpoint for each participant in the conference.
- The focus SHOULD accept conference state changes reported in **conference-view** and **users** elements only. These elements are inside the **conference-info** document. It SHOULD ignore everything else.

Extensions can specify alternate or extension algorithms to suit other types of focus or MCU implementations, as long as the client interface remains identical to this specification.

Aggregation Algorithm

The focus SHOULD validate the MCU published document using the MCU conference roster syntax rules specified in section [2.2.5](#).

The focus SHOULD apply the procedures described in [RFC4575] section 3.7 for processing the received **notification** with the following extensions:

- The **version** number MUST be maintained per MCU.
- A copy of the conference state for each MCU MUST be maintained locally, independent of the other MCUs, and hence the processing for a received notification affects only the local state of that MCU.
- Except for the **conference-view** and **users** elements and their subelements, all other elements MUST be ignored for processing purposes. The subelements of the **conference-view** and **users** elements MUST be updated in the local state using the algorithm specified in [RFC4575] section 3.7.
- The focus MUST accept a participant listed in the MCU notification, even if the participant is not connected to the focus.

If any local MCU state was changed by executing the preceding algorithm, the focus MUST construct and send out a conference event notification to all watchers. The generated document MUST conform to the conference roster syntax rules specified in section [2.2.4](#).

3.4.4.3 MCU Role

When an **MCU** is bootstrapped for a **conference**, it MUST establish a notification channel with the **focus**. The actual protocol for establishing the notification channel is outside the scope of this specification, but it can be based on [\[RFC3265\]](#) section 3.1. However, the **notification** document MUST conform to the application/conference-info+xml document format.

3.4.4.3.1 MCU Notifications

The **MCU** behaves as a notifier, as specified in [\[RFC4575\]](#) section 3.5. It MUST report conference event **notifications** to the **focus**.

This specification defines the following extensions to [RFC4575] section 3.6:

- On being bootstrapped for a **conference**, an MCU MUST publish a full notification populating the **conference-view** element with all relevant elements. The **entity-state** subelement MUST be included. Other subelements are optional.
- An MCU SHOULD generate partial **conference-info** notifications whenever the state of any **conference-view** subelement changes.
- An MCU SHOULD generate partial **user** notifications whenever the state of any connected user changes.

3.4.5 Message Processing Events and Sequencing Rules

Except as specified in the following subsections, the processing rules follow [\[RFC4575\]](#) sections 3.5, 3.6, 3.7 and [\[RFC3265\]](#) section 3.1.

3.4.5.1 Client Role

This section specifies the message processing events and sequencing rules for the client role that are related to conference subscriptions and notifications.

3.4.5.1.1 Processing the First Full Notification

On receipt of the first full **notification**, the client MUST terminate the 32-second timer, as specified in section [3.4.2.1](#).

The client MUST process the first full notification received using the procedures specified in [\[RFC4575\]](#) section 3.7.

The client SHOULD extract all of the **entry** elements listed in the **conf-uris** element of the **conference** document and use them to construct the **MCU-Conference-URI** table using the **conf-uris** semantics defined in section [2.2.2.4](#).

The client MUST extract its own focus **endpoint** element state to determine whether it has been admitted immediately into the conference or placed in the **lobby**.

A client placed in the lobby SHOULD wait for a full notification from the **focus** with the **endpoint** element state set to "connected" to determine that it has been connected to the conference.

A client placed in the lobby SHOULD implement a timeout to disconnect from the conference if not admitted within a specific amount of time chosen by the client.

3.4.5.2 Focus Role

This section specifies the message processing events and sequencing rules for the **focus** role that are related to **conference** subscriptions and **notifications**.

3.4.5.2.1 Generating a Full Notification Document

The **focus** MUST immediately send a full **notification** document to the client when the client establishes a subscription with the focus. If the **ms-piggyback-first-notify** extension is supported, this document SHOULD be returned in the **200 OK** response body itself.

The generated full notification document MUST conform to the conference roster syntax rules in section [2.2.4](#). In addition, the document generated by the focus MUST include the following child elements of the **conference-info** element:

conf-uris: Lists all the **MCUs** provisioned for the **conference** and their corresponding **MCU-Conference-URI**, as specified in section [2](#).

conference-view: SHOULD initially list the **entity-view** of the focus itself. Subsequent full notifications SHOULD list the full **conference-view**, which includes the **entity-view** elements for the focus and the MCUs.

users: SHOULD list all the participants in the conference, including those who are connected only to MCUs.

3.4.5.2.2 SIP Error Response Codes

None.

3.4.6 Timer Events

3.4.6.1 Client Role

If the 32-second timer defined in section [3.4.2](#) fires, the client SHOULD fail the conference subscription because it has not received any **notifications**, and perform a user notification action.

3.4.7 Other Local Events

None.

3.5 Common Conference Control Details

After a participant joins a **conference**, it can perform various conference control operations. In general, **conference control requests** can be classified into three categories:

- **Focus Commands.** These are commands that terminate on the **focus** and do not involve **MCU** interaction. These commands change some conference state and result in **notification** to watchers. No commands are currently defined for this category.
- **MCU Commands.** These are commands that are authorized by the focus but are simply forwarded to the MCU. Thus, no focus state is modified unless the MCU generates a notification indicating the change of state. In this case, the client **MUST** indicate the MCU to process the command. Such commands can be specified by extension specifications.
- **General Conference Commands.** These are commands that are processed by the focus, as well as by all MCUs in the conference. For such commands, the focus and all of the MCUs can generate conference-state change notifications, which are then sent to all participants. The **modifyConferenceLock** command is an example of this category.

Regardless of the **command-type**, all **conference control commands** share a common protocol sequence that is described later in this section. The protocol sequence is divided into client, focus, and MCU roles. The following figure shows a basic conference control call flow.

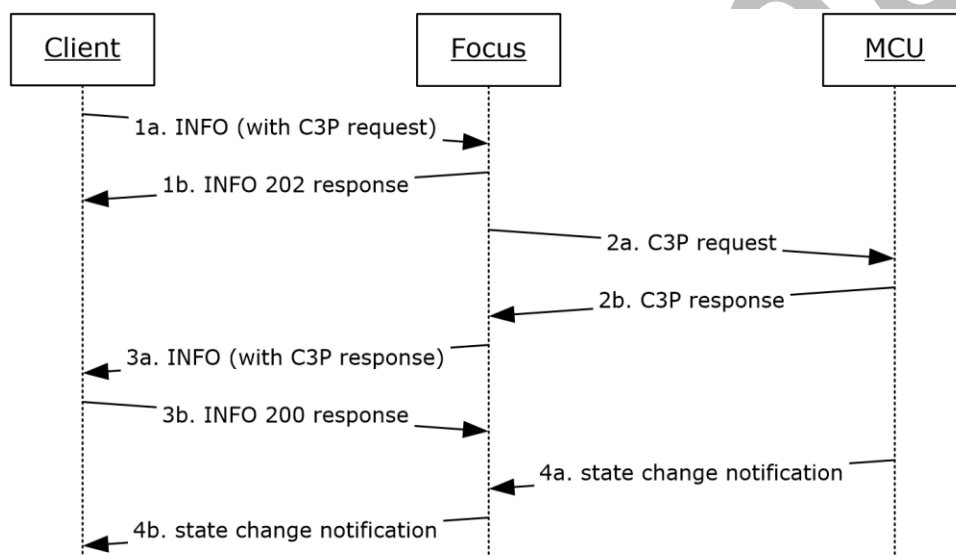

Figure 9: Basic conference control call flow

In step 1a, the client sends a conference control request to the focus. This is done by sending a **SIP INFO** request with a C3P-request body. The focus accepts the SIP INFO and responds to it with a SIP INFO **202 Accepted** response indicating that the command is being processed.

If the command semantics involved processing by MCUs, the focus sends the request to the MCUs and waits for their response. This is shown as steps 2a and 2b.

When command execution completes, the focus generates a C3P **final response** and sends it to the client over a SIP INFO response. The client responds with a SIP **200 OK** response indicating that it has received the response. This is shown as steps 3a and 3b.

If the command execution results in a change of conference state, the MCUs and focus generate state change notifications to all watchers. This is shown as steps 4a and 4b.

Processing details are described in the following subsections. Note that some commands require intermediate processing that is specified in the subsection. Extensions to this specification can also specify extra processing behavior.

The protocol used between the focus and the MCUs for exchanging conference control requests, responses, and notifications is outside the scope of this specification. This protocol deals only with the client-to-focus interface.

Detailed command call flow examples are given in section 4.

3.5.1 Abstract Data Model

This section describes a conceptual model of possible data organization that an implementation maintains to participate in this protocol. The described organization is provided to facilitate the explanation of how the protocol behaves. This document does not mandate that implementations adhere to this model, as long as their external behavior is consistent with that described in this document.

Note that this conceptual data model can be implemented using a variety of techniques. An implementation is at liberty to implement the data model in any way that is convenient.

3.5.1.1 Client Role

Recommendations for implementers:

- The client maintains a table, such as a table of **MCU-Conference-URI** values, which is keyed by **MCU-Type**, and stores the MCU-Conference-URI for each **MCU**.
- The client maintains a table of pending requests. This table is keyed by the C3P Request-Id and store all of the C3P requests that have been sent to the server but have not received **final responses** and have not timed out.

3.5.1.2 Focus Role

The term **focus** is used synonymously with server in the following section.

The focus SHOULD use an enumeration variable, **participantRole**, to track the granted role for each participant. The valid values for this enumeration are "presenter" and "attendee".

It is recommended that the focus maintain a table of C3P command types that maps all supported C3P commands to an enumeration that has two values:

- "CommandTypeConference"
- "CommandTypeUser"

These values indicate whether a command operates on the conference as a whole or on a particular user.

The focus SHOULD use a Boolean variable, **isFirstPartyRequest**, to track whether a request is a **first-party request** or **third-party request**.

3.5.2 Timers

3.5.2.1 Client Role

A timer is associated with every **conference control command** sent to the **focus**. The initial value of this timer SHOULD be set to 32 seconds. Every time a C3P "pending" response is received for that

command, the timer SHOULD be extended by three minutes, or 180 seconds. If no further responses are received within the timeout interval, the command MUST be considered timed-out.

3.5.3 Initialization

3.5.3.1 Client Role

The client MUST have established a valid signaling **dialog** with the **focus**, as illustrated in section [4.2.1](#).

It MUST have constructed the **MCU-Conference-URI** table using the procedures described in section [3.4.5.1.1](#).

3.5.4 Higher-Layer Triggered Events

3.5.4.1 Client Role

Except as specified in the following sections, the rules for message processing are as specified in [\[RFC3261\]](#) section 8.1.3 and [\[RFC2976\]](#) section 2.4.

3.5.4.1.1 Sending a Conference Control Request

The client constructs a **SIP** INFO request within the signaling **dialog** established with the **focus**. The constructed SIP INFO request MUST conform to the conference control message syntax rules in section [2.2.1.5](#). The request MUST contain a valid C3P request, as specified in section [2.2.3](#), populating all of the relevant attributes and elements needed for processing the command. The client sends this request to the focus. The client then starts the transaction timer, as specified in section [3.5.2](#).

3.5.4.2 Focus Role

The following sections specify the higher-layer triggered events for the **focus** role related to the common conference control.

3.5.4.2.1 Receiving a Conference Control Request

On receipt of a **SIP** INFO request containing the **conference control command**, the **focus** MUST validate that the SIP INFO request belongs to a known signaling **dialog** that is not currently in the **lobby**.

It SHOULD then parse and validate the C3P request body using the C3P request syntax rules specified in section [2.2.3](#).

If parsing or validation fails, the focus SHOULD reject the request.

If parsing and validation succeed, the focus SHOULD immediately generate a SIP **202 Accepted** response indicating that the request has been accepted for further processing.

It SHOULD then begin processing the command, as specified in the following sections.

3.5.4.2.2 Authorizing a Conference Control Request

This section describes a conceptual authorization model that an implementation performs to participate in this protocol. The described organization is provided to facilitate the explanation of how the protocol behaves. This document does not mandate that implementations adhere to this model as long as their external behavior is consistent with that described in this document.

The **focus** SHOULD initialize the **participantRole** variable to the role of the sending participant.

The focus SHOULD then determine the command contained in the request.

It SHOULD then find the **CommandType** by looking it up in the C3P command type table, as described in section [3.5.1.2](#).

If the **CommandType** is "UserLevel", the focus SHOULD extract the **userEntity URI** from the command body.

The focus SHOULD then check whether the URI specified in **userEntity** matches the URI specified in the **from** attribute of the C3P request using standard URI matching rules, as specified in [\[RFC3261\]](#) section 19.1.4. The focus SHOULD set the variable **isFirstPartyRequest** to "true" if they match, and to "false" if they do not match.

The focus SHOULD reject a request with an "unauthorized" C3P response if the **CommandType** is "ConferenceLevel" and the **participantRole** is "attendee".

The focus SHOULD reject a request with an "unauthorized" C3P response if the **CommandType** is "UserLevel", if **isFirstPartyRequest** is set to "false", and the **participantRole** is "attendee".

This concludes the basic authorization logic. Extensions to this specification can specify additional authorization procedures to be carried out by the focus.

3.5.4.2.3 Processing a Command

The **focus** SHOULD then process the command using the processing rules specified for the command.

Detailed command-level processing rules are specified in subsequent sections.

3.5.4.2.3.1 SIP Response Codes

The following table specifies additional failure response codes that are defined for the SIP INFO request.

| SIP response code | Reason |
|-------------------|---|
| 503 | Service unavailable. One or more services required to execute the command are currently unavailable. This is a retrievable failure. |
| 603 | Non-retriable command-specific failure. This is also used if the command specified an MCU-Type that is not enabled for the conference. |

3.5.4.2.3.2 Common C3P Failure Response Codes

The following table specifies generic processing failure response codes that are applicable to all commands.

| C3P response code | Reason |
|-------------------|---|
| unauthorized | Forbidden. User does not have the privileges to perform the specified conference control command . |
| Timeout | Timeout encountered when processing a command. This is a retrievable failure. |

| C3P response code | Reason |
|-------------------|--|
| requestMalformed | The specified body is not valid according to the syntax rules specified for the command. |
| notSupported | The specified command is not implemented. |
| serverBusy | Service unavailable. One or more services required to execute the command are currently unavailable or too busy to accept new requests. This is a retrievable failure. |
| otherFailure | Unspecified failure. Command-specific failure codes can be defined for this case. |

The following table specifies some specific processing failure response codes applicable to most commands. For exact applicability, refer to the command schema.

| C3P response code | Reason |
|-----------------------|---|
| conferenceDoesntExist | Specified conference does not exist. |
| userDoesntExist | Specified participant does not exist. |
| endpointDoesntExist | Specified target endpoint does not exist. |

3.5.5 Message Processing Events and Sequencing Rules

3.5.5.1 Client Role

Unless specified otherwise, the message processing rules follow the procedures described in [\[RFC2976\]](#) section 2.4.

3.5.5.1.1 Receiving SIP 202 Response to the INFO Request

A client can ignore the **202 Accepted** response from the server. The client SHOULD then wait for another INFO response from the server containing the command response.

3.5.5.1.2 Receiving SIP 200 Response to the INFO Request

If the client receives a **200 OK** response to its INFO request, it SHOULD then extract the C3P **response** body contained in the 200 OK response and process it as specified in section [3.5.5.1.4](#).

3.5.5.1.3 Receiving an INFO Request From the Focus

If the client receives an INFO request from the **focus**, it SHOULD respond immediately with a **200 OK** to the INFO request.

It SHOULD then extract the C3P response body contained in the request and process it as specified in section [3.5.5.1.4](#).

3.5.5.1.4 Processing a Command Response

The client SHOULD parse and validate the document using the syntax rules specified in section [2.2.3](#).

It SHOULD then find the corresponding request from the PendingRequestTable, using **requestId** as the key. If a matching request is not found, it is likely that the request has timed out or has been cancelled by the application, hence the client SHOULD silently drop the response.

If the response is a C3P "pending" response (as indicated by the **code** attribute), the client SHOULD extend its transaction timer, as described in section 3.5.2, and can then ignore the response.

If the response is a C3P "success" or "failure" response, the client SHOULD remove the request from the PendingRequestTable. It SHOULD also stop any pending timers. It SHOULD then process the response in the context of the request.

The actual processing action for a C3P response is outside the scope of this specification, but it can include alerting the participant that the command succeeded or failed.

3.5.5.1.5 Processing Incoming Notifications

If the client receives conference state change **notifications** on the subscription channel, it SHOULD process them and modify its conference state, as described in section 3.5. This SHOULD be done independent of the command processing described in this section.

3.5.5.2 Focus Role

The following sections specify the message processing and sequencing rules for the focus role related to the common conference control.

3.5.5.2.1 Forwarding Command to an MCU

If the command needs to be processed by a specific **MCU**, the **focus** SHOULD forward the command to the MCU.

The focus SHOULD then wait for responses from the MCU and forward all responses individually to the client. The protocol for creating and sending commands to the MCUs and processing the responses received from them is outside the scope of this specification.

The command processing is considered complete when the focus has sent a **final response** to the client.

3.5.5.2.2 Forking Command to All MCUs

If the command needs to be processed by all of the **MCUs** participating in the **conference**, such as the **modifyConferenceLock** C3P request, the **focus** SHOULD forward the command to the MCU.

The focus SHOULD also generate a final C3P response back to the client, giving the result of executing the command at the focus.

The protocol for creating and sending commands to the MCUs and processing the responses received from them is outside the scope of this specification.

This specification does not define any particular mechanism for processing the responses received from the MCUs for the forking scenario.

3.5.5.2.3 Completing Command Processing

When the **focus** completes processing for the command, it SHOULD generate a **SIP INFO** response and send it back to the client. The INFO response SHOULD have a valid C3P response body containing the result of executing the command.

If the local conference state was modified, the focus SHOULD generate a conference state change **notification** to all watchers.

3.5.6 Timer Events

3.5.6.1 Client Role

If no response has been received for an outgoing request, and the timer fires, the client SHOULD treat this timeout event as if the command has failed and perform the processing steps outlined earlier.

3.5.6.2 Focus Role

If the timer fires and the request is still in processing, the **focus** SHOULD generate and send a "pending" response to the client to indicate that the request is being processed. It SHOULD then reinitialize the timer to 28 seconds.

3.5.7 Other Local Events

None.

3.6 Conference Control – `modifyConferenceLock` Command Details

The **`modifyConferenceLock`** command controls the current lock state of the conference. After the conference is locked, no new users are allowed to join. This is a conference level command.

Before issuing this command, a client SHOULD check the permissible settings by reading the extensions specified in section [2.2.2.3](#).

The lock state is maintained by the **focus** and the **MCUs**. They report the lock state independent of each other. The global conference lock state is the lock state reported by the focus. A client SHOULD track the lock state of the MCUs independent of the global conference lock state.

Unless specified otherwise, the protocol details specified in section [3.5](#) SHOULD be used for command processing.

Detailed command call flows are given in section [4](#).

3.6.1 Abstract Data Model

This section describes a conceptual model of possible data organization that an implementation maintains to participate in this protocol. The described organization is provided to facilitate the explanation of how the protocol behaves. This document does not mandate that implementations adhere to this model as long as their external behavior is consistent with that described in this document.

The abstract data model specified in section [3.5](#) is extended as specified in the following subsections.

3.6.1.1 Focus Role

The term **focus** is used synonymously with server in the following section.

The focus SHOULD use a Boolean variable, **`currentConferenceLockState`**, to track the current lock state of the conference.

Note that this conceptual data model can be implemented using a variety of techniques. An implementation is at liberty to implement the data model in any way that is convenient.

3.6.2 Timers

Timers are specified in section [3.5](#).

3.6.3 Initialization

Initialization steps are specified in section [3.5](#).

3.6.4 Higher-Layer Triggered Events

None.

3.6.5 Message Processing Events and Sequencing Rules

The rules for message processing and sequencing are specified in section [3.5](#).

3.6.6 Timer Events

The rules for timer event processing are specified in section [3.5](#).

3.6.7 Other Local Events

None.

3.7 Conference Control – modifyUserRoles Command Details

The **modifyUserRoles** command is used to modify the role of a participant. This is a user level command.

The participant role is maintained by both the **focus** and the **MCUs**, and each entity reports the user role in the **conference** roster independent of the other entity. The global user role for the conference is the role reported by the focus.

Unless specified otherwise, the protocol details specified in section [3.5](#) SHOULD be used for command processing.

Detailed command call flows are given in section [4](#).

3.7.1 Abstract Data Model

This section describes a conceptual model of possible data organization that an implementation maintains to participate in this protocol. The described organization is provided to facilitate the explanation of how the protocol behaves. This document does not mandate that implementations adhere to this model as long as their external behavior is consistent with that described in this document.

The abstract data model specified in section [3.5](#) is extended as specified in the following subsections.

3.7.1.1 Focus Role

The term **focus** is used synonymously with server in the following section.

The focus SHOULD use the enumeration **participantRole** to track the current role of the participant in the conference. This enumeration maps to the **user-role** element defined in the application/conference-info+xml schema.

Note that the preceding conceptual data model can be implemented using a variety of techniques. An implementation is at liberty to implement the data model in any way that is convenient.

3.7.2 Timers

Timers are specified in section [3.5](#).

3.7.3 Initialization

Initialization steps are specified in section [3.5](#).

3.7.4 Higher-Layer Triggered Events

None.

3.7.5 Message Processing Events and Sequencing Rules

The rules for message processing and sequencing are as specified in section [3.5](#).

3.7.6 Timer Events

The rules for timer event processing are specified in section [3.5](#).

3.7.7 Other Local Events

None.

3.8 Conference Control – deleteUser Command Details

The **deleteUser** command is used to eject a participant. This is a user level command.

Unless specified otherwise, the protocol details specified in section [3.5](#) SHOULD be used for command processing.

Detailed command call flows are given in section [4](#).

3.8.1 Abstract Data Model

The abstract data model for processing **conference control commands** is specified in section [3.5](#).

3.8.2 Timers

Timers are specified in section [3.5](#).

3.8.3 Initialization

Initialization steps are specified in section [3.5](#).

3.8.4 Higher-Layer Triggered Events

None.

3.8.5 Message Processing Events and Sequencing Rules

3.8.5.1 Focus Role

Unless otherwise specified, the rules for message processing and sequencing are as specified in section [3.5](#).

The **focus** SHOULD reject a request if the **endpointEntity** element is specified. When the focus ejects a participant, it MUST perform the following steps:

- Terminate all of the subscription **dialogs** for that user, for all **endpoints**. This involves sending a **NOTIFY** with an **Expires** header field whose value is "0", as specified in [\[RFC3265\]](#). If the participant was ejected from the **conference**, the focus MUST add a **subscription-state** header with a **Reason** header field with its **text** parameter set to "ParticipantRemoved". If the participant was ejected from the **lobby**, the focus MUST add a **subscription-state** header with a **Reason** header field with its **text** parameter set to "Participant Denied".
- Terminate all signaling dialogs for that user, for all endpoints. This involves sending a BYE to the participant. If the participant was ejected from the conference, the focus MUST add a **Reason** header field with its **text** parameter set to "Participant Removed". If the participant was ejected from the lobby, the focus MUST add a **Reason** header field with its **text** parameter set to "Participant Denied".
- It is recommended that the subscription dialog termination be done before the signaling dialog termination.
- The focus MUST notify all remaining participants in the conference with the updated state.
- The focus MUST copy and send the command to all the **MCUs** in the conference so that they can also eject the user.

3.8.6 Timer Events

The rules for timer event processing are specified in section [3.5](#).

3.8.7 Other Local Events

None.

3.9 Conference Control – deleteConference Command Details

The **deleteConference** command is used to end a **conference**, eject all participants, and deactivate all **MCUs** from that conference. This is a conference level command.

Note that the **deleteConference** command sent to the **focus** from the client MUST NOT modify the provisioning state of the conference. The **Focus Factory** SHOULD be used to delete the conference from the system to completely deprovision the conference, as specified in [\[MS-CONFPRO\]](#).

Unless specified otherwise, the protocol details specified in section [3.5](#) SHOULD be used for command processing.

Detailed command call flows are given in section [4](#).

3.9.1 Abstract Data Model

The abstract data model for processing **conference control commands** is specified in section [3.5](#).

3.9.2 Timers

Timers are specified in section [3.5](#).

3.9.3 Initialization

Initialization steps are specified in section [3.5](#).

3.9.4 Higher-Layer Triggered Events

None.

3.9.5 Message Processing Events and Sequencing Rules

None.

3.9.6 Timer Events

The rules for timer event processing are specified in section [3.5](#).

3.9.7 Other Local Events

None.

3.10 Conference Control – addUser Dial-out Command Details

The **addUser** dial-out command is used to connect a participant to an **MCU**. This section specifies the basic **addUser** dial-out behavior that all client, **focus**, and MCU implementations adhere to. This command is used only when the MCU supports **SIP** as the protocol for user session establishment.

This is a user level command. This command is sent to the MCU through the focus. The **addUser** dial-out protocol sequence is shown in the following figure.

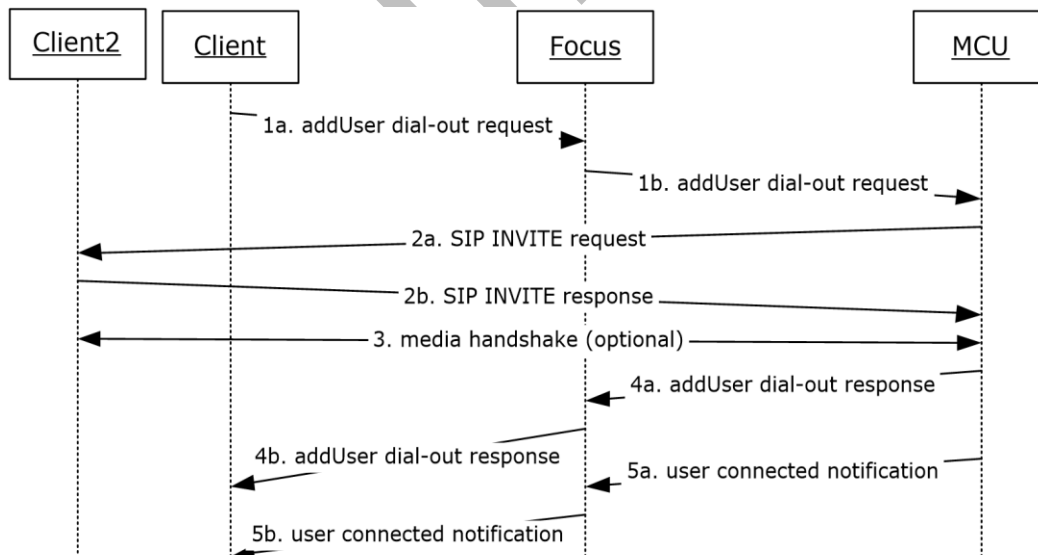

Figure 10: addUser Dial-out call flow

The client sends an **addUser** dial-out request, over a SIP INFO, to the focus. The focus authorizes it and then forwards it to the MCU. This is shown in steps 1a and 1b. The **addUser** dial-out request MUST have an **mcuUri** attribute with value "IMMCU" or "AVMCU"; "ASMCU" and "DMCU" are not supported.

The MCU processes the **addUser** dial-out request. It can generate an **addUser** dial-out pending C3P responses, which is not shown in the preceding figure.

The MCU then sends an **INVITE** request to the user **endpoint** specified in the request that gets a response. This is shown as steps 2a and 2b. Note that the INVITE request can be sent to some other endpoint of the user or to a different user. For simplicity, these are not shown here. This specification does not specify the actual contents of the **SIP request** body or the **SIP response** body. Extensions to this specification can define the actual contents, such as the **Session Description Protocol (SDP)** format, as described in [\[RFC3264\]](#) section 5.

At this point, the client and the MCU can negotiate media. Extensions to this specification can define how the media negotiation is done. This is shown as step 3.

After the user is connected to the MCU, the MCU generates an **addUser** dial-out C3P response indicating that the command has succeeded. This is shown in steps 4a and 4b.

Finally, the MCU notifies the focus that the user has connected, as shown in step 5a, which in turn is propagated to all conference watchers, as shown in step 5b.

MCU implementers can specify extensions to the **addUser** dial-out protocol.

Unless specified otherwise, the protocol details specified in section [3.5](#) SHOULD be used for command processing.

Detailed command call flows are given in section [4](#).

3.10.1 Abstract Data Model

The abstract data model for processing **conference control commands** is specified in section [3.5](#).

3.10.2 Timers

Timers are specified in section [3.5](#).

3.10.3 Initialization

Initialization steps are specified in section [3.5](#).

3.10.4 Higher-Layer Triggered Events

3.10.4.1 MCU Role

Unless otherwise specified in the following subsection, the rules are as specified in section [3.5](#).

3.10.4.1.1 Constructing an Outgoing SIP INVITE Request

Unless otherwise specified in the following section, the rules for constructing and sending an **INVITE** request are as specified in [\[RFC3261\]](#) section 13.2.1.

When the **MCU** receives an **addUser** dial-out request, it SHOULD initiate a signaling/media handshake with that user. The outgoing INVITE SHOULD be constructed using the following rules:

- The **URI** in the SIP **From** header field MUST be set to the **MCU-Conference-URI**.
- The URI in the SIP **To** header field SHOULD be set to the **SIP** URI specified in the **entity** attribute of the **user** element of the dial-out request.
- The SIP **Request-URI** header field SHOULD be set as follows:
 - If the **refer-to-uri** attribute is supplied in the **addUser** dial-out request, it SHOULD be used to populate the SIP **Request-URI** header field.
 - If the **endpoint-uri** attribute is supplied in the **addUser** dial-out request, it SHOULD be used to populate the SIP **Request-URI** header field, provided that **refer-to-uri** is empty.
 - Otherwise, the SIP **Request-Uri** header field SHOULD be set to the URI in the **To** header field.
- If the **refer-to-uri** attribute is specified, the MCU SHOULD parse this attribute, treating it as a SIP URI. It SHOULD extract all of the headers present and add them to the outgoing request, as defined in [RFC3261] section 19.

Extensions can define additional rules for session establishment between the MCU and the client.

3.10.5 Message Processing Events and Sequencing Rules

3.10.5.1 MCU Role

Unless otherwise specified, the rules for message processing and sequencing are as specified in section [3.5](#).

The MCU MUST generate a user connected **notification** if the dial-out requests and the user successfully connect to the MCU. An example is given in section [4](#).

3.10.6 Timer Events

The rules for timer event processing are specified in section [3.5](#).

3.10.7 Other Local Events

None.

3.11 Conference Control – addUser Dial-in Command Details

The **addUser** dial-in command is used to connect a participant to an **MCU**. This section specifies the basic **addUser** dial-in behavior to which all client, **focus**, and MCU implementations adhere.

The **addUser** dial-in protocol sequence is shown in the following figure.

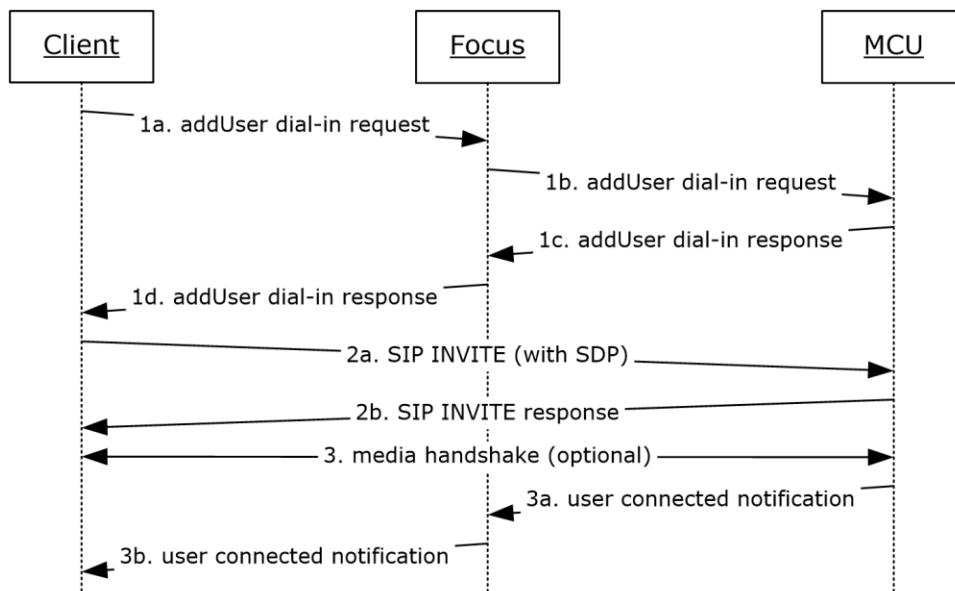

Figure 11: addUser Dial-in call flow

In the preceding figure, the client sends an **addUser** dial-in request, over **SIP INFO**, to the focus. The focus authorizes it and then forwards it to the MCU. This is shown in steps 1a and 1b.

The MCU processes the **addUser** dial-in request and then responds with an **addUser** dial-in response to the focus, which is forwarded by the focus to the client, as shown in steps 1c and 1d.

Subsequent to processing the **addUser** dial-in response, the client establishes a session with the MCU. The figure titled "addUser Dial-in call flow" assumes a SIP-based MCU. Thus, in step 2a, the client sends an **INVITE** request to the MCU. This specification does not specify the actual contents of the **SIP request** body. Extensions to this specification can define the actual contents, such as the **SDP** format. The MCU accepts the INVITE request, processes the request, and then responds to it in step 2b.

At this point, the client and the MCU might negotiate media. Extensions to this specification can define how media negotiation is done.

At the end of media negotiation, the MCU notifies the focus that the user has connected, as shown in step 3a, which in turn is propagated to all conference watchers, as shown in step 3b.

The dial-in request can be sent by the client or by the focus itself to the MCU. It specifies the user who is attempting to join the MCU. The dial-in response indicates whether the MCU is prepared to accept the user's join request and also conveys extra information necessary to attempt the join. The dial-in request is followed by a client-to-MCU-specific signaling handshake such as an INVITE. This is a user level command.

The MCU MAY fail the **addUser** dial-in request if it has not indicated successful activation, for example by publishing its **entity-view** element in the conference document. MCU implementers can specify extensions to the **addUser** dial-in protocol.

Unless specified otherwise, the protocol details specified in section [3.5](#) SHOULD be used for command processing.

Detailed command call flows are given in section [4](#).

3.11.1 Abstract Data Model

The abstract data model for processing **conference control commands** is specified in section [3.5](#).

3.11.2 Timers

Timers are specified in section [3.5](#).

3.11.3 Initialization

Initialization steps are specified in section [3.5](#).

3.11.4 Higher-Layer Triggered Events

3.11.4.1 Client Role

Unless otherwise specified in the following subsections, the rules for constructing the outgoing **addUser** dial-in request are as specified in section [3.5](#).

3.11.4.1.1 Constructing an Outgoing addUser Dial-in Request

The **entity** attribute of the **user** element of the **addUser** dial-in request MUST be the same as the SIP URI in the **From** header field. In other words, the dial-in request MUST be for the initiator and cannot be done on behalf of some other user.

3.11.4.2 MCU Role

MCU extensions to this document can specify the actual processing behavior of the **addUser** dial-in request.

3.11.5 Message Processing Events and Sequencing Rules

3.11.5.1 Client Role

Unless otherwise specified in the following subsections, the rules for message processing and sequencing are as specified in section [3.5](#).

3.11.5.1.1 Processing an addUser Dial-in Response

When an **addUser** dial-in response is received, the client SHOULD parse and extract the **connection-info** element to be used for constructing the outgoing **INVITE** request, if applicable, as defined in the following subsection.

3.11.5.1.2 Constructing an Outgoing SIP INVITE Request

Unless otherwise specified in this section, the rules for constructing and sending an **INVITE** request are as specified in [\[RFC3261\]](#) section 13.2.1.

The outgoing INVITE SHOULD be constructed using the following rules:

- The **SIP URI** in the **From** header field MUST be set to the client's SIP URI. This MUST also be the same as the SIP URI specified in the **entity** attribute of the **user** element of the dial-out request.
- The SIP URI in the **To** header field SHOULD be set to the **MCU-Conference-URI** extracted from the **addUser** dial-in response specified in section [2.2.3.18](#).

- The SIP **Request-URI** header field SHOULD be set to the SIP URI in the **To** header field.

Extensions can define additional rules for session establishment between the **MCU** and the client.

3.11.5.2 MCU Role

Unless otherwise specified in the following subsection, the rules for message processing and sequencing are as specified in section [3.5](#).

3.11.5.2.1 Constructing an addUser Dial-in Response

An MCU SHOULD generate an **addUser** dial-in response after it has finished processing the **addUser** request.

The **connection-info** element of the **addUser** dial-in response SHOULD be populated with key-value pairs that are then used by the client to initiate a connection. If the MCU supports user session establishment through **SIP**, it is recommended that it adds the following **keys** to the **connection-info** element, as specified in section [2.2.3.18](#).

- **Mcu-Server-Uri**
- **MCU-Conference-URI**

The MCU MUST generate a user state change **notification** on successful processing of a dial-in request.

Dial-in examples are given in section [4](#).

3.11.6 Timer Events

The rules for timer event processing are specified in section [3.5](#).

3.11.7 Other Local Events

None.

3.12 Conference Control – getConference Command Details

This section follows the behavior described in product behavior note [<43>](#).

The **getConference** command is used to retrieve the current active roster state. This is a conference-level command.

Unless specified otherwise, the protocol details specified in section [3.5](#) SHOULD be used for command processing.

Detailed command call flows are given in section [4](#).

3.12.1 Abstract Data Model

The abstract data model for processing **conference control commands** is specified in section [3.5](#).

3.12.2 Timers

Timers are specified in section [3.5](#).

3.12.3 Initialization

Initialization steps are specified in section [3.5](#).

3.12.4 Higher-Layer Triggered Events

3.12.4.1 Focus Role

The term **focus** is used synonymously with server in the following section.

The focus SHOULD first apply the processing rules specified in section [3.5](#). After that, the focus SHOULD generate and send the full **notification** document, as specified in section [3.4.5.2.1](#).

The response contains the current roster state of the active **conference** in the conference roster document format, as described in section [2.2.4](#).

The difference between the roster state retrieved using the **SUBSCRIBE** and **getConference** is that the **getConference** response contains information which is potentially encrypted using the key provided in the **getConference** request.

The response to the **getConference** request sent to the focus might contain sensitive information such as the conference key and the encrypted conferencing join web URL. The sensitive information is encrypted using the public key provided by the client. If the client does not provide a public key, the response does not contain any sensitive information.

If an **encryption-key** is specified, and a **conference-key** exists for the conference, encrypt the **conference-key** using the public key from the specified x509-certificate and include it in the **getConference** response; otherwise omit **conference-key** from the **getConference** response.

If an **encryption-key** is specified, and a conferencing join web **URL** exists for the conference, encrypt the URL using the public key from the specified x509-certificate and include it in the **conf-uris** element as part of the **getConference** response; otherwise, omit the conferencing join web URL from the **getConference** response. **X.509** is specified in [\[RFC3280\]](#).

3.12.5 Message Processing Events and Sequencing Rules

None.

3.12.6 Timer Events

The rules for timer event processing are specified in section [3.5](#).

3.12.7 Other Local Events

None.

3.13 Conference Control – modifyEndpoint Command Details

The **modifyEndpoint** command is used to modify the **endpoint** extensions of a **participant**. This is a user level command.

As an example, the recording notification feature can use this command for communication between client and server. The client is responsible to report recording state change, and the server is responsible to receive and notify the recording state change.

The **endpoint** entities are maintained by the **focus**, and each entity reports the extensions of an **endpoint** of a participant that is independent of the other entity.

Unless specified otherwise, the protocol details specified in section [3.5](#) SHOULD be used for command processing.

Detailed command call flows with the recording notification feature as an example are given in section [4](#).

3.13.1 Abstract Data Model

The abstract data model for processing **conference control commands** is specified in section [3.5](#).

3.13.2 Timers

Timers are specified in section [3.5](#).

3.13.3 Initialization

Initialization steps are specified in section [3.5](#).

3.13.4 Higher-Layer Triggered Events

None.

3.13.5 Message Processing Events and Sequencing Rules

None.

3.13.6 Timer Events

The rules for timer event processing are specified in section [3.5](#).

3.13.7 Other Local Events

None.

3.14 Conference Control – setLobbyAccess Command Details

This section follows the behavior described in product behavior note [<44>](#).

The **setLobbyAccess** command is used to admit or deny users from the conference lobby. This is a user-level command.

Unless specified otherwise, the protocol details specified in section [3.5](#) SHOULD be used for command processing.

Detailed command call flows are given in section [4](#).

3.14.1 Abstract Data Model

The abstract data model for processing **conference control commands** is specified in section [3.5](#).

3.14.2 Timers

Timers are specified in section [3.5](#).

3.14.3 Initialization

Initialization steps are specified in section [3.5](#).

3.14.4 Higher-Layer Triggered Events

3.14.4.1 Focus Role

Unless otherwise specified, the rules for message processing and sequencing are as specified in section [3.5](#).

The focus SHOULD process each user specified in the **setLobbyAccess** request separately. The request is considered a success so long as the requestor was authorized and there was not an internal failure processing the request, even if no users were actually admitted or denied access because of the command.

If the value of the **access** element of the request is "granted", the command is meant to admit users from the lobby. Each **status.reason** attribute in the response is determined as follows:

- "conferenceFull": The focus SHOULD enforce any implementation-defined limits on the number of participants admitted to a conference and assign this value to any participants who are not admitted because of size limitations. The participant is neither admitted nor denied access to the conference. Such participants remain connected to the conference in the lobby and can be admitted later if space becomes available. If some, but not all, of the specified users will fit in the conference, the implementation is free to choose which users to admit and which to leave in the lobby.
- "userDoesntExist": There was no participant connected to the conference, in lobby or not, with the given URI. If the participant left or was denied access by another command before the command was processed, this reason is used.
- "alreadyGranted": The participant was already admitted to the conference by a previous command.
- "success": The participant was admitted from the lobby and granted a place in the conference.

If the value of the **access** element of the request is "denied", the command is meant to eject users from the lobby. Each **status.reason** attribute in the response is determined as follows:

- "userDoesntExist": As for the "granted" case.
- "alreadyGranted": The participant was already admitted to the conference by a previous command. **setLobbyAccess** cannot be used to eject a participant already admitted to the conference.
- "success": The participant was ejected from the lobby.

3.14.5 Message Processing Events and Sequencing Rules

3.14.5.1 Focus Role

Each participant admitted via this command MUST receive a full conference notify constructed as specified in section [3.4.5.2.1](#).

Each participant ejected via this command MUST have all signaling and subscription dialogs with the conference terminated, as specified in section [3.8.5.1](#).

Other participants in the conference that are watching the roster and not in the lobby after the completion of this command MUST receive a notification indicating the change of lobby status for users whose status is changed by this command. This notification MAY use partial notification semantics.

3.14.6 Timer Events

The rules for timer event processing are specified in section [3.5](#).

3.14.7 Other Local Events

None.

3.15 Conference Control – modifyConference Command Details

This section follows the behavior described in product behavior note [<45>](#).

The **modifyConference** command is used to change the state of MCUs in the conference. This is a conference level command.

3.15.1 Abstract Data Model

The abstract data model for processing **conference control commands** is specified in section [3.5](#).

3.15.2 Timers

Timers are specified in section [3.5](#).

3.15.3 Initialization

The abstract data model for processing **conference control commands** is specified in section [3.5](#).

3.15.4 Higher-Layer Triggered Events

3.15.4.1 MCU Role

MCU extensions to this document can specify the actual processing behavior of the **modifyConference** request.

3.15.5 Message Processing Events and Sequencing Rules

None.

3.15.6 Timer Events

The rules for timer event processing are specified in section [3.5](#).

3.15.7 Other Local Events

None.

4 Protocol Examples

4.1 Simple Join

A standard call flow sequence is shown in the following figure. The sequence shown is based on the protocol sequence described in section 3.2.

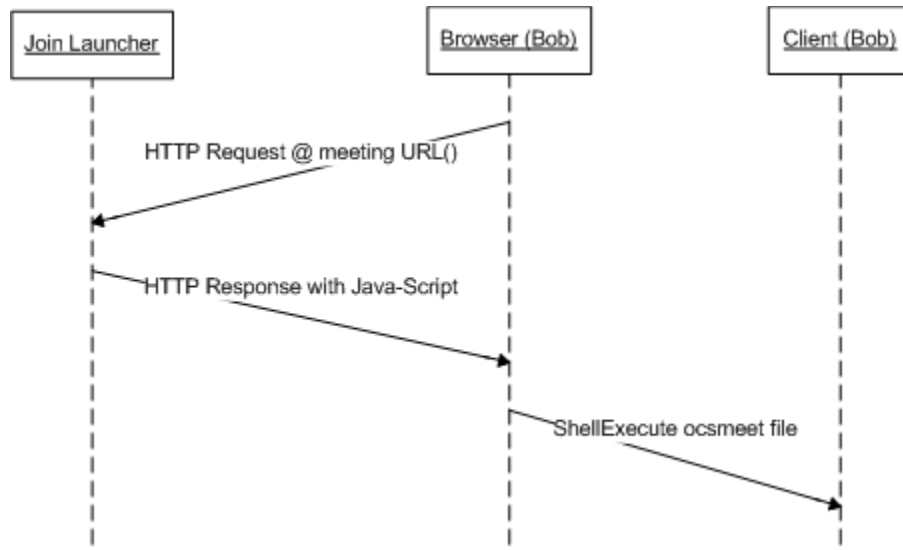

Figure 12: Standard call flow sequence

When user "Bob" initiates a Simple Join by clicking on the conferencing join web **URL**, Bob's browser, which is Internet Explorer in this case, sends an **HTTP** request to the Join Manager as shown in the following example:

```
GET /meet/bob/MJMVY7RF HTTP/1.1
Accept: image/gif, image/jpeg, image/pjpeg, application/x-ms-application, application/vnd.ms-xpsdocument, application/xaml+xml, application/x-ms-xbap, application/vnd.ms-excel, application/vnd.ms-powerpoint, application/msword, application/x-shockwave-flash
Accept-Language: en-us
User-Agent: Mozilla/4.0 (compatible; MSIE 8.0; Windows NT 6.0; Trident/4.0; GTB6;; CWADS32; SLCC1; .NET CLR 2.0.50727; Tablet PC 2.0; .NET CLR 1.1.4322; InfoPath.2; .NET CLR 3.5.21022; MS-RTC LM 8; .NET CLR 3.5.30729; .NET CLR 3.0.30618)
Accept-Encoding: gzip, deflate
Host: www.fabrikam.com
Connection: Keep-Alive
Cookie: MC1=GUID=a0e6a97cda7641a496b14ca0665f35a7&HASH=a0e6&LV=20099&V=3;
WT_FPC=id=131.107.0.106-1797821888.30059372:lv=1265936990571:ss=1265936990571
```

The Join Manager parses the conferencing join web URL, creates the ocsmeet XML document string, and sends an HTTP response with embedded script to Bob's browser, as shown in the following example:

```
HTTP/1.1 200 OK
Cache-Control: private
Content-Type: text/html; charset=utf-8
Server: Microsoft-IIS/7.5
X-AspNet-Version: 4.0.30319
X-Powered-By: ASP.NET
Date: Tue, 01 Jan 2013 00:38:58 GMT
```

Content-Length: 12272

```
<!--NOTE: If DOCTYPE element is present, it causes the iFrame to be displayed in a small-->
<!--portion of the browser window instead of occupying the full browser window.-->
<html xmlns="http://www.w3.org/1999/xhtml" class="reachJoinHtml">
<head>
  <meta http-equiv="X-UA-Compatible" content="IE=10; IE=9; IE=8;"/>
  <meta name="viewport" content="width=device-width; initial-scale=1.0; maximum-scale=1.0;
user-scalable=0;" />
  <title>Microsoft Lync</title>
  <script type="text/javascript">
    var reachURL =
"https://lyncb.lyncweb.fabrikam.com/lwa/WebPages/LwaClient.aspx?legacy=RmFsc2U!&xml=PD94bWwgd
mVyc2lvbj0iMS4wIiBlbmNvZGluz0idXRmLTgiPz48Y29uZilpbmZvIHhtbG5zOnhzaD0iaHR0cDovL3d3dy53My5vcm
cvMjAwMS9YTUxY2Y2hlbWEiIHhtbG5zOnhzaT0iaHR0cDovL3d3dy53My5vcmcvMjAwMS9YTUxY2Y2hlbWEtaW5zdGFuY2U
iIHhtbG5zPSJodHRwOi8vc2NoZWlhcyc5taWNYb3NvZnQuY29tL3J0Yy8yMDA5LzA1L3NpbXBsZWpvaW5jb25mZG9jIj48
Y29uZi11cmk-
c2lwOnJwdXJpQG1pY3Jvc29mdC5jb207Z3JldTtvcGFxZWU9YXBwOmNvbWY6Zm9jdXMM6aWQ6ODFRTU5TRTg8L2NvbWYtd
XJpPjxzXJ2ZXItZGltdGltZT4xNdc8L3NlcnZlcil0aW11PjxvcmVnaW5hbC1pbmNvbWluZy11cmw-
aHR0cHM6Ly9qb2luLm1pY3Jvc29mdC5jb20vbWVldC9ycHVyaS84MVFNt1NFODwv3JpZ2luYWwtaW5jb21pbmctdXJSP
jxb25mLWtleT44MVFNt1NFODwvY29uZilrZXk-
PGZhbGxiYWNrLXVyYD5odHRwczovL2pvaW4ubW1jcm9zb2Z0LmNvbS9tZWV0L3JwdXJpLzgzUU1OU0U4P3NsPTwvZmFsb
GJhY2stXJsPjx1Y3dhLXVyYD5odHRwczovL2x5bmMwYi5seW5jd2ViLm1pY3Jvc29mdC5jb20vdWN3YS92MS9hcHBSaW
NhdGlbnM8L3Vjd2EtdXJsPjx1Y3dhLWV4dC11cmw-
aHR0cHM6Ly9seW5jMGJubHluY3dlYi5taWNYb3NvZnQuY29tL3Vjd2EvdjEvYXBwBwG1jYXRpb25zPC91Y3dhLWV4dC11c
mw-
PHVjd2EtaW50LXVyYD5odHRwczovLzAwMGR0azVsNTB3ZWlucmVkbW9uZC5jb3JwLm1pY3Jvc29mdC5jb20vdWN3YS92M
S9hcHBSaWNhdGlbnM8L3Vjd2EtaW50LXVyYD5odHRwczovLzAwMGR0azVsNTB3ZWlucmVkbW9uZC5jb3JwLm1pY3Jvc29mdC5jb20vdWN3YS92M
JlOWY3MGRhODwvZGVzZW1ldHJ5LWlkPjwvY29uZilpbmZvPg!!";
    var escapedXML = "\x3c\x3fxml version\x3d\x221.0\x22 encoding\x3d\x22utf-
8\x22\x3f\x3e\x3cconf-info
xmlns\x3axsd\x3d\x22http\x3a\x2f\x2fwww.w3.org\x2f2001\x2fXMLSchema\x22
xmlns\x3axsi\x3d\x22http\x3a\x2f\x2fwww.w3.org\x2f2001\x2fXMLSchema-instance\x22
xmlns\x3d\x22http\x3a\x2f\x2fschemas.microsoft.com\x2frtc\x2f2009\x2f05\x2fsimplejoinconfdoc\
\x22\x3e\x3cconf-
uri\x3esip\x3abob\x40fabrikam.com\x3bgruu\x3bopaque\x3bdapp\x3aconf\x3afocus\x3aid\x3aMJMVY7RF
\x3c\x2fconf-uri\x3e\x3cserver-time\x3e147\x3c\x2fserver-time\x3e\x3coriginal-incoming-
url\x3ehttps\x3a\x2f\x2fjoin.fabrikam.com\x2fmeet\x2fbob\x2fMJMVY7RF\x3c\x2foriginal-
incoming-url\x3e\x3cconf-key\x3eMJMVY7RF\x3c\x2fconf-key\x3e\x3cfallback-
url\x3ehttps\x3a\x2f\x2fjoin.fabrikam.com\x2fmeet\x2fbob\x2fMJMVY7RF\x3fs1\x3d\x3c\x2ffallbac
k-url\x3e\x3cucwa-
url\x3ehttps\x3a\x2f\x2flyncb.lyncweb.fabrikam.com\x2fucwa\x2fv1\x2fapplications\x3c\x2fucwa-
url\x3e\x3cucwa-ext-
url\x3ehttps\x3a\x2f\x2flyncb.lyncweb.fabrikam.com\x2fucwa\x2fv1\x2fapplications\x3c\x2fucwa-
ext-url\x3e\x3cucwa-int-
url\x3ehttps\x3a\x2f\x2fServer57c.corp.fabrikam.com\x2fucwa\x2fv1\x2fapplications\x3c\x2fucwa-
-int-url\x3e\x3ctelemetry-id\x3ea1dfa279-0859-48eb-ada4-30d2e9f70da8\x3c\x2ftelemetry-
id\x3e\x3c\x2fconf-info\x3e";
    var validMeeting = "True";
    var reachClientRequested = "False";
    var htmlLwaClientRequested = "False";
    var currentLanguage = "en-US";
    var reachClientProductName = "Lync Web App";
    var blockPreCU2Clients = "False";
    var isNokia = "False";
    var isAndroid = "False";
    var isWinPhone = "False";
    var isIPhone = "False";
    var isIPad = "False";
    var isMobile = "False";
    var isUnsupported = "False";
    var domainOwnerJoinLauncherUrl = "";
    var lyncLaunchLink =
"conf:sip:bob@fabrikam.com;gruu;opaque=app:conf:focus:id:MJMVY7RF%3Frequired-media=audio";
    var diagInfo = "Machine\x3aServer58ABrowserId\x3aMozilla\x2f5.0 \x28compatible\x3b
MSIE 10.0\x3b Windows NT 6.2\x3b WOW64\x3b Trident\x2f6.0\x29Join attempted
at\x28UTC\x29\x3a1\x2f1\x2f2013 12\x3a38\x3a58 AMTelemetryId\x3aa1dfa279-0859-48eb-ada4-
30d2e9f70da8Incoming URL\x3ahttps\x3a\x2f\x2fjoin.fabrikam.com\x2fmeet\x2fbob\x2fMJMVY7RF";
    var userExperience = "1500";
```



```

var isLwaEnabled = "True";
var escalateToDesktop = "False";
var resourceUrl =
"/meet/JavaScriptResourceHandler.ashx?lcs_w15_cu15.0.8308.168&language=";
var telemetryId = "alda279-0859-48eb-ada4-30d2e9f70da8";
var errorCode = "-1";
var reachClientTitleString = "Microsoft Lync Web App";
var mobileW1ProtocolHandler = "lync://";
var mobileW2ProtocolHandler = "lync15://";
var lync15CommonProtocolHandler = "lync15:";
var lync15ClassicProtocolHandler = "lync15classic:";
var mlxProtocolHandler = "lync15mlx:";

toggllediag = function () {
    if (userExperience.toLowerCase() != defaultExperienceVersion) {
        if (document.getElementById("diagInfoText15").style.display == "none") {
            document.getElementById("diagInfoText15").style.display = "block";
            document.getElementById("diagLabel215").style.display = "block";
        }
        else {
            document.getElementById("diagLabel215").style.display = "none";
            document.getElementById("diagInfoText15").style.display = "none";
        }
    }
    else { // 1400 behavior
        if (isMobile.toLowerCase() == "true") {
            if (document.getElementById("diagInfoTextMobile").style.display ==
"none") {
                document.getElementById("diagInfoTextMobile").style.display =
"block";
            }
            else {
                document.getElementById("diagLabel2Mobile").style.display = "block";
            }
        }
        else {
            if (document.getElementById("diagInfoText").style.display == "none") {
                document.getElementById("diagInfoText").style.display = "block";
                document.getElementById("diagLabel2").style.display = "block";
            }
            else {
                document.getElementById("diagLabel2").style.display = "none";
                document.getElementById("diagInfoText").style.display = "none";
            }
        }
    }
}
</script>
<script type="text/javascript"
src="/meet/JavaScript/Utilities.js?lcs_w15_cu15.0.8308.168"></script>
<script type="text/javascript"
src="/meet/JavaScript/PluginLoader.js?lcs_w15_cu15.0.8308.168"></script>
<script type="text/javascript"
src="/meet/JavaScript/Launch.js?lcs_w15_cu15.0.8308.168"></script>
<link rel="stylesheet" type="text/css"
href="/meet/Resources/ReachClient.css?lcs_w15_cu15.0.8308.168" />

</head>
<body onload="mainWindow.OnLoad();" class="reachJoinBody">
/* HTML BODY */
</body>
</html>

```

Bob's browser receives the response, the script is executed on the computer starting from the **OnLoad()** method in the Launch.js file, does the necessary checks, loads the ActiveX Controls or Firefox Plug-ins, and eventually calls into a method into the ActiveX Control or Firefox Plug-in. The API then writes the content of the ocsmeet XML document to a file in the temporary location on the computer, defined by the **GetTempFolder()** Windows API, which is accessible to that user, and eventually calls **ShellExecute()** on that file path to start the client on Bob's computer.

4.2 Joining and Leaving a Conference

A standard call-flow sequence is shown in the following figure. This sequence is based on the protocol sequence described in section 3.2.

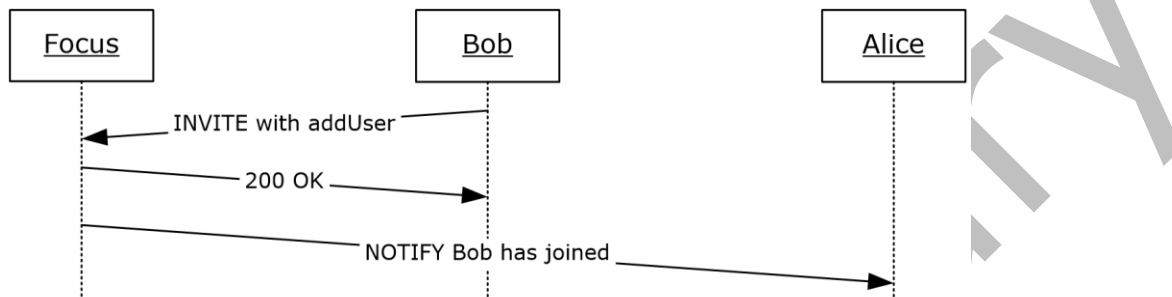

Figure 7: Joining a conference

4.2.1 Joining a Conference

Conference-aware client "Bob" joins a conference by establishing a **SIP signaling dialog** with the **focus**. It first sends an **INVITE** request as follows.

```

INVITE sip:Alice@fabrikam.com;gruu;opaque=app:conf:focus:id:5D3747C SIP/2.0
From: <sip:bob@fabrikam.com>;tag=958d8a3fbc;epid=c5574cd6b6
To: <sip:Alice@fabrikam.com;gruu;opaque=app:conf:focus:id:5D3747C>
Content-Type: application/cccp+xml
Content-Length: 736
Via: SIP/2.0/TLS 10.1.2.50:4237
Max-Forwards: 70
Call-ID: ad0da39085864c768630674f17692101
CSeq: 1 INVITE
Contact: <sip:bob@fabrikam.com;opaque=user:epid:HT07tI-f3F-fdDyic8rblwAA;gruu>
User-Agent: UCCP/2.0.6362.0 OC/2.0.6362.0 (Microsoft Office Communicator)
Supported: timer
ms-keep-alive: UAC;hop-hop=yes
Proxy-Authorization: NTLM qop="auth", realm="SIP Communications Service", opaque="99052D67",
crand="6475c82f", cnum="82", targetname="sip/ocs.fabrikam.com",
response="01000000e44de73c187afc887f8f5ef3"
<request C3PVersion="1"
  to="sip:Alice@fabrikam.com;gruu;opaque=app:conf:focus:id:5D3747C "
  from="sip:bob@fabrikam.com" requestId="1"
  xmlns="urn:ietf:params:xml:ns:cccp"
  xmlns:ci="urn:ietf:params:xml:ns:conference-info">
  <addUser>
    <conferenceKeys confEntity="sip:Alice@fabrikam.com;gruu;opaque=app:conf:focus:id:5D3747C
  />
  <user entity="sip:bob@fabrikam.com">
    <roles>
      <entry>presenter</entry>
    </roles>
    <endpoint entity="{339F927D-6AD4-4090-9104-8414B99EE045}" />
  </user>
</addUser>

```

</request>

When the **addUser** is accepted, the focus responds with the granted role in the **200 OK** response.

SIP/2.0 200 Invite dialog created

```
From: <sip:bob@fabrikam.com>;tag=958d8a3fbc;epid=c5574cd6b6
To: <sip:Alice@fabrikam.com;gruu;opaque=app:conf:focus:id:5D3747C>;tag=0D440080
Via: SIP/2.0/TLS 10.1.2.50:4237
Max-Forwards: 70
Call-ID: ad0da39085864c768630674f17692101
CSeq: 1 INVITE
Contact: <sip:ocs.exchange.corp.fabrikam.com:5061;transport=tls>;isfocus
Authentication-Info: NTLM rspauth="01000000180D3416377238967F8F5EF3", srand="D6CD41F7",
snum="180", opaque="99052D67", qop="auth", targetname="sip/ocs.fabrikam.com", realm="SIP
Communications Service"
Content-Length: 1095
Content-Type: application/cccp+xml
Allow: INVITE, BYE, ACK, CANCEL, INFO, UPDATE
Session-Expires: 7200;refresher=uac
Require: timer
Supported: timer

<response requestId="1" C3PVersion="1"
  from="sip:Alice@fabrikam.com;gruu;opaque=app:conf:focus:id:5D3747C "
  to="sip:bob@fabrikam.com" code="success"
  xmlns="urn:ietf:params:xml:ns:cccp"
  xmlns:ci="urn:ietf:params:xml:ns:conference-info">
  <addUser>
    <conferenceKeys confEntity="sip:Alice@fabrikam.com;gruu;opaque=app:conf:focus:id:5D3747C
  "/>
    <user entity="sip:bob@fabrikam.com">
      <roles>
        <entry>presenter</entry>
      </roles>
    </user>
  </addUser>
</response>
```

It then notifies the existing **conference** participants that the user has joined the conference. In the following example, user "alice@fabrikam.com" is assumed to have already joined and subscribed to the conference. An actual subscription example is shown in section [4.3](#).

```
BENOTIFY sip:10.1.2.50:2383;transport=tls;ms-opaque=02e9aelf28;ms-received-cid=00031600;grid
SIP/2.0
To: <sip:Alice@fabrikam.com>;tag=ccb81c3509;epid=c5574cd6b6
From: <sip:Alice@fabrikam.com;gruu;opaque=app:conf:focus:id:5D3747C>;tag=0D440086
Content-Type: application/conference-info+xml
Event: conference
Call-ID: 72d6a36a36784cf58e7e7ab1a51deca2
CSeq: 12 BENOTIFY
Authentication-Info: NTLM rspauth="01000000180D3416377238967F8F5EF3", srand="D6CD41F7",
snum="180", opaque="99052D67", qop="auth", targetname="sip/ocs.fabrikam.com", realm="SIP
Communications Service"
Max-Forwards: 70
Via: SIP/2.0/TLS 10.54.67.185:5061;branch=z9hG4bK86DA089F.780A7BCA;branched=FALSE
subscription-state: active;expires=3600
<... Content-Length snipped ...>

<conference-info
  entity="sip:Alice@fabrikam.com;gruu;opaque=app:conf:focus:id:5D3747C "
  state="partial" version="2"
  xmlns="urn:ietf:params:xml:ns:conference-info"
  xmlns:mhci="http://schemas.fabrikam.com/rtc/2005/08/confinfoextensions">
```

```

<users state="partial">
  <user entity="sip:bob@fabrikam.com" state="full">
    <display-text>Bob Freer</display-text>
    <roles>
      <entry>presenter</entry>
    </roles>
    <endpoint entity="{339F927D-6AD4-4090-9104-8414B99EE045}"
      msci:session-type="focus"
      msci:endpoint-
uri="sip:bob@fabrikam.com;opaque=user:epid:AD0UTS5Dc1Oh9zyK1XWK2AAA;gruu">
      <status>connected</status>
    </endpoint>
  </user>
</users>
</conference-info>

```

In this same example, if Bob is joining the conference on behalf of Carol, the **INVITE** and the **BENOTIFY** are as follows.

```

INVITE sip:Alice@fabrikam.com;gruu;opaque=app:conf:focus:id:5D3747C SIP/2.0
From: <sip:bob@fabrikam.com>;tag=958d8a3fbc;epid=c5574cd6b6
To: <sip:Alice@fabrikam.com;gruu;opaque=app:conf:focus:id:5D3747C>
Content-Type: application/cccp+xml
Content-Length: 736
Via: SIP/2.0/TLS 10.1.2.50:4237
Max-Forwards: 70
Call-ID: ad0da39085864c768630674f17692101
CSeq: 1 INVITE
Contact: <sip:bob@fabrikam.com;opaque=user:epid:HT07tI-f3F-fdDyic8rblwAA;gruu>
User-Agent: UCCP/2.0.6362.0 OC/2.0.6362.0 (Microsoft Office Communicator)
Supported: timer
p-session-on-behalf-of: sip:carol@fabrikam.com
ms-keep-alive: UAC;hop-hop=yes
Proxy-Authorization: NTLM qop="auth", realm="SIP Communications Service", opaque="99052D67",
crand="6475c82f", cnum="82", targetname="sip/ocs.fabrikam.com",
response="01000000e44de73c187afc887f8f5ef3"
<request C3PVersion="1"
  to="sip:Alice@fabrikam.com;gruu;opaque=app:conf:focus:id:5D3747C "
  from="sip:bob@fabrikam.com" requestId="1"
  xmlns="urn:ietf:params:xml:ns:cccp"
  xmlns:ci="urn:ietf:params:xml:ns:conference-info">
  <addUser>
    <conferenceKeys confEntity="sip:Alice@fabrikam.com;gruu;opaque=app:conf:focus:id:5D3747C
"/>
    <user entity="sip:bob@fabrikam.com">
      <roles>
        <entry>presenter</entry>
      </roles>
      <endpoint entity="{09AA504C-BA41-4458-8669-8F35470F6CA2}">
        <session-on-behalf-of>
          <entity> sip:carol@fabrikam.com </entity>          </session-on-behalf-of>
        </endpoint>
      </user>
    </addUser>
  </request>

```

```

BENOTIFY sip:10.1.2.50:2383;transport=tls;ms-opaque=02e9aef28;ms-received-cid=00031600;grid
SIP/2.0
To: <sip:Alice@fabrikam.com>;tag=ccb81c3509;epid=c5574cd6b6
From: <sip:Alice@fabrikam.com;gruu;opaque=app:conf:focus:id:5D3747C>;tag=0D440088
Content-Type: application/conference-info+xml
Event: conference
Call-ID: 72d6a36a36784cf58e7e7ab1a51deca2
CSeq: 12 BENOTIFY

```

```

Authentication-Info: NTLM rspauth="01000000180D3416377238967F8F5EF3", srand="D6CD41F7",
snum="180", opaque="99052D67", qop="auth", targetname="sip/ocs.fabrikam.com", realm="SIP
Communications Service"
Max-Forwards: 70
Via: SIP/2.0/TLS 10.54.67.185:5061;branch=z9hG4bK86DA089F.780A7BCA;branched=FALSE
subscription-state: active;expires=3600
<... Content-Length snipped ...>

<conference-info
  entity="sip:Alice@fabrikam.com;gruu;opaque=app:conf:focus:id:5D3747C "
  state="partial" version="2"
  xmlns="urn:ietf:params:xml:ns:conference-info"
  xmlns:mhci="http://schemas.fabrikam.com/rtc/2005/08/confinfoextensions">
  <users state="partial">
    <user entity="sip:bob@fabrikam.com" state="full">
      <display-text>Bob Freer</display-text>
      <roles>
        <entry>presenter</entry>
      </roles>
      <endpoint entity="{339F927D-6AD4-4090-9104-8414B99EE045}"
        mhci:session-type="focus"
        mhci:endpoint-
uri="sip:bob@fabrikam.com;opaque=user:epid:AD0UTS5Dc1Oh9zyK1XWK2AAA;gruu">
        <status>connected</status>
        <session-on-behalf-of>
          <entity> sip:carol@fabrikam.com </entity>          </session-on-behalf-of>
        </endpoint>
      </user>
    </users>
  </conference-info>

```

4.2.2 Updating the Dialog

A standard call-flow sequence for updating a signaling **dialog** with the **focus** is shown in the following figure, and is based on a negotiated Session-Timer. The sequence shown here is based on the protocol sequence described in section 3.2.

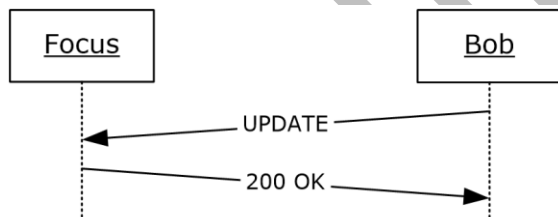

Figure 8: Updating a signaling dialog

The client sends an UPDATE request to the focus to refresh the existing signaling dialog.

```

UPDATE sip:Alice@fabrikam.com;gruu;opaque=app:conf:focus:id:5D3747C SIP/2.0
From: <sip:bob@fabrikam.com>;tag=958d8a3fbc;epid=c5574cd6b6
To: <sip:Alice@fabrikam.com;gruu;opaque=app:conf:focus:id:5D3747C>;tag=0D440080
Content-Length: 0
Via: SIP/2.0/TLS 10.1.2.50:4237
Max-Forwards: 70
Call-ID: ad0da39085864c768630674f17692101
CSeq: 5 UPDATE
Contact: <sip:bob@fabrikam.com;opaque=user:epid:HT07tI-f3F-fdDyic8rblwAA;gruu>
User-Agent: UCCP/2.0.6362.0 OC/2.0.6362.0 (Microsoft Office Communicator)
Supported: timer

```

```
Proxy-Authorization: NTLM qop="auth", realm="SIP Communications Service",
opaque="99052D67", crand="6475c82f", cnum="82", targetname="sip/ocs.fabrikam.com",
response="01000000e44de73c187afc887f8f5ef3"
```

After processing the UPDATE, the focus responds with a **200 OK**.

```
SIP/2.0 200 OK
From: <sip:bob@fabrikam.com>;tag=958d8a3fbc;epid=c5574cd6b6
To: <sip:Alice@fabrikam.com;gruu;opaque=app:conf:focus:id:5D3747C>;tag=0D440080
Via: SIP/2.0/TLS 10.1.2.50:4237
Max-Forwards: 70
Call-ID: ad0da39085864c768630674f17692101
CSeq: 5 UPDATE
Contact: <sip:ocs.exchange.corp.fabrikam.com:5061;transport=tls>;isfocus
Authentication-Info: NTLM rspauth="01000000180D3416377238967F8F5EF3", srand="D6CD41F7",
snum="180", opaque="99052D67", qop="auth", targetname="sip/ocs.fabrikam.com", realm="SIP
Communications Service"
Content-Length: 0
Session-Expires: 7200;refresher=uac
Require: timer
Supported: timer
```

4.2.3 Leaving a Conference

A standard call-flow sequence for leaving a **conference** is shown in the following figure. The client sends a BYE request to leave the conference. The **focus** notifies other participants in the conference that the participant has left. The sequence shown here is based on the protocol sequence described in section 3.2.

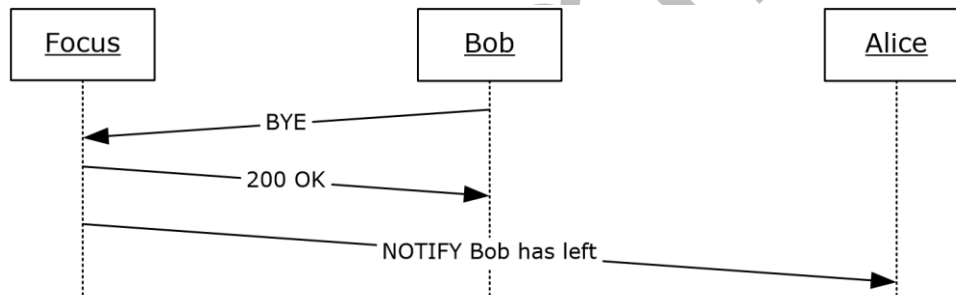

Figure 9: Leaving a conference

```
BYE sip:Alice@fabrikam.com;gruu;opaque=app:conf:focus:id:5D3747C SIP/2.0
From: <sip:bob@fabrikam.com>;tag=958d8a3fbc;epid=c5574cd6b6
To: <sip:Alice@fabrikam.com;gruu;opaque=app:conf:focus:id:5D3747C>;tag=0D440080
Content-Length: 0
Via: SIP/2.0/TLS 10.1.2.50:4237
User-Agent: UCCP/2.0.6362.0 OC/2.0.6362.0 (Microsoft Office Communicator)
Proxy-Authorization: NTLM qop="auth", realm="SIP Communications Service",
opaque="99052D67", crand="6475c82f", cnum="82", targetname="sip/ocs.fabrikam.com",
response="01000000e44de73c187afc887f8f5ef3"
```

```
Max-Forwards: 70
Call-ID: ad0da39085864c768630674f17692101
CSeq: 10 BYE
Contact: <sip:bob@fabrikam.com;opaque=user:epid:HT07tI-f3F-fdDyic8rblwAA;gruu>
```

The focus processes the participant leave request and responds with a **200 OK**.

```
SIP/2.0 200 OK
From: <sip:bob@fabrikam.com>;tag=958d8a3fbc;epid=c5574cd6b6
To: <sip:Alice@fabrikam.com;gruu;opaque=app:conf:focus:id:5D3747C>;tag=0D440080
Via: SIP/2.0/TLS 10.1.2.50:4237
Max-Forwards: 70
Call-ID: ad0da39085864c768630674f17692101
CSeq: 10 BYE
Authentication-Info: NTLM rspauth="01000000180D3416377238967F8F5EF3", srand="D6CD41F7",
snum="180", opaque="99052D67", qop="auth", targetname="sip/ocs.fabrikam.com", realm="SIP
Communications Service"
Content-Length: 0
```

The focus then sends a **notification** to the watchers in the conference indicating that Bob has left the conference.

```
BENOTIFY sip:10.1.2.50:2383;transport=tls;ms-opaque=02e9aelf28;ms-received-
cid=00031600;grid SIP/2.0
To: <sip:Alice@fabrikam.com>;tag=ccb81c3509;epid=c5574cd6b6
From: <sip:Alice@fabrikam.com;gruu;opaque=app:conf:focus:id:5D3747C>;tag=0D440080
Content-Type: application/conference-info+xml
Event: conference
Call-ID: 72d6a36a36784cf58e7e7ab1a51deca2
CSeq: 12 BENOTIFY
Authentication-Info: NTLM rspauth="01000000180D3416377238967F8F5EF3", srand="D6CD41F7",
snum="180", opaque="99052D67", qop="auth", targetname="sip/ocs.fabrikam.com", realm="SIP
Communications Service"
Max-Forwards: 70
Via: SIP/2.0/TLS 10.54.67.185:5061;branch=z9hG4bK86DA089F.780A7BCA;branched=FALSE
subscription-state: active;expires=3600
<... Content-Length header snipped ... >

<conference-info entity="sip:Alice@fabrikam.com;gruu;opaque=app:conf:focus:id:5D3747C "
state="partial" version="2"
xmlns="urn:ietf:params:xml:ns:conference-info"
xmlns:msci="http://schemas.fabrikam.com/rtc/2005/08/confinfoextensions">
  <users state="partial">
    <user entity="sip:bob@fabrikam.com" state="deleted"/>
  </users>
</conference-info>
```

4.3 Subscribing to a Conference

A standard call-flow sequence for subscribing to conference **notifications** is shown in the figure titled "Establishing a subscription" in section [4.3.1](#). The sequence shown here is based on the protocol sequence described in section [3.4](#).

4.3.1 Establishing a Subscription

The client sends a SIP **SUBSCRIBE** request to the **focus** and establishes a subscription **dialog** with the focus. The focus generates and sends **notifications** to the client whenever the conference state changes.

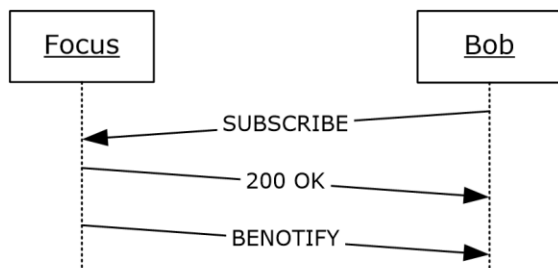

Figure 10: Establishing a subscription

```

SUBSCRIBE sip:Alice@fabrikam.com;gruu;opaque=app:conf:focus:id:5D3747C SIP/2.0
From: <sip:bob@fabrikam.com>;tag=958d8a3fbc;epid=c5574cd6b6
To: <sip:Alice@fabrikam.com;gruu;opaque=app:conf:focus:id:5D3747C>
Via: SIP/2.0/TLS 10.1.2.50:4237
Max-Forwards: 70
Call-ID: 72d6a36a36784cf58e7e7ab1a51deca2
CSeq: 1 SUBSCRIBE
Contact: <sip:bob@fabrikam.com;opaque=user:epid:HT07tI-f3F-fdDyic8rblwAA;gruu>
User-Agent: UCCP/2.0.6362.0 OC/2.0.6362.0 (Microsoft Office Communicator)
Event: conference
Accept: application/conference-info+xml
Supported: com.microsoft.autoextend
Supported: ms-benotify
Proxy-Require: ms-benotify
Content-Length: 0
Proxy-Authorization: NTLM qop="auth", realm="SIP Communications Service",
opaque="99052D67", crand="6475c82f", cnum="82", targetname="sip/ocs.fabrikam.com",
response="01000000e44de73c187afc887f8f5ef3"
  
```

The focus processes the subscription and responds with a **200 OK**.SIP/2.0 200 OK

```

From: <sip:bob@fabrikam.com>;tag=958d8a3fbc;epid=c5574cd6b6
To: <sip:Alice@fabrikam.com;gruu;opaque=app:conf:focus:id:5D3747C>
Via: SIP/2.0/TLS 10.1.2.50:4237
Max-Forwards: 70
Call-ID: 72d6a36a36784cf58e7e7ab1a51deca2
CSeq: 1 SUBSCRIBE
Contact: <sip:ocs.exchange.corp.fabrikam.com:5061;transport=tls>;isfocus
Authentication-Info: NTLM rspauth="01000000180D3416377238967F8F5EF3", srand="D6CD41F7",
snum="180", opaque="99052D67", qop="auth", targetname="sip/ocs.fabrikam.com", realm="SIP
Communications Service"
Content-Length: 0
subscription-state: active;expires=3618
  
```

The focus then sends the first full notification to this participant, listing the complete conference state. **BENOTIFY** is used in this example because the client indicated support for the BENOTIFY request. Otherwise, a SIP **NOTIFY** request would be sent by the focus to the client.

```

BENOTIFY sip:10.1.2.50:2383;transport=tls;ms-opaque=02e9aelf28;ms-received-
cid=00031600;grid SIP/2.0
To: <sip:bob@fabrikam.com>;tag=ccb81c3509;epid=c5574cd6b6
From: <sip:Alice@fabrikam.com;gruu;opaque=app:conf:focus:id:5D3747C>;tag=0D440080
Content-Length: 2373
Content-Type: application/conference-info+xml
Event: conference
Call-ID: 72d6a36a36784cf58e7e7ab1a51deca2
CSeq: 2 BENOTIFY
  
```

Authentication-Info: NTLM rspauth="01000000180D3416377238967F8F5EF3", srand="D6CD41F7",
snum="180", opaque="99052D67", qop="auth", targetname="sip/ocs.fabrikam.com", realm="SIP
Communications Service"
Max-Forwards: 70
Via: SIP/2.0/TLS 10.54.67.185:5061;branch=z9hG4bK86DA089F.780A7BCA;branched=FALSE
subscription-state: active;expires=3600

```
<conference-info xmlns="urn:ietf:params:xml:ns:conference-info"
  xmlns:mhci="http://schemas.fabrikam.com/rtc/2005/08/confinfoextensions"
  xmlns:msim="http://schemas.fabrikam.com/rtc/2005/08/imconfinfoextensions"
  xmlns:ci="urn:ietf:params:xml:ns:conference-info"
  xmlns:cis="urn:ietf:params:xml:ns:conference-info-separator"
  entity="sip:alice@fabrikam.com;gruu;opaque=app:conf:focus:id:5D3747C"
  state="full" version="4">
  <conference-description>
    <conf-uris>
      <entry>
        <uri>sip:alice@fabrikam.com;gruu;opaque=app:conf:chat:id:5D3747C</uri>
        <display-text>chat</display-text>
        <purpose>chat</purpose>
      </entry>
      <entry>
        <uri>sip:alice@fabrikam.com;gruu;opaque=app:conf:meeting:id:5D3747C</uri>
        <display-text>meeting</display-text>
        <purpose>meeting</purpose>
      </entry>
      <entry>
        <uri>sip:alice@fabrikam.com;gruu;opaque=app:conf:audio-video:id:5D3747C</uri>
        <display-text>audio-video</display-text>
        <purpose>audio-video</purpose>
      </entry>

      <entry>
        <uri>sip:alice@fabrikam.com;gruu;opaque=app:conf:
        applicationsharing:id:5D3747C</uri>
        <display-text>applicationsharing</display-text>
        <purpose>applicationsharing</purpose>
      </entry>

    </conf-uris>
  </conference-description>
  <users state="full">
    <user entity="sip:alice@fabrikam.com" state="full">
      <display-text>Alice Gates</display-text>
      <roles>
        <entry>presenter</entry>
      </roles>
      <endpoint entity="{09AA504C-BA41-4458-8669-8F35470F6CA2}" mhci:session-
      type="focus" mhci:endpoint-uri="sip:alice@fabrikam.com;opaque=user:epid:HT07tI-f3F-
      fdDyic8rblwAA;gruu">
        <status>connected</status>
      </endpoint>
    </user>
  </users>

  <mhci:conference-view ci:state="full">
    <mhci:entity-view ci:state="full"
    entity="sip:alice@fabrikam.com;gruu;opaque=app:conf:focus:id:5D3747C">
      <mhci:entity-state>
        <mhci:locked>false</mhci:locked>
      </mhci:entity-state>
    </mhci:entity-view>
    <mhci:entity-view ci:state="full"
    entity="sip:alice@fabrikam.com;gruu;opaque=app:conf:audio-video:id:5D3747C">
      <mhci:entity-capabilities>
        <msav:capabilities>
          <msav:supports-audio>true</msav:supports-audio>
        </msav:capabilities>
      </mhci:entity-view>
    </mhci:entity-view>
  </mhci:conference-view>
</conference-info>
```

```

    <msav:supports-video>true</msav:supports-video>
  </msav:capabilities>
</mcsi:entity-capabilities>
<mcsi:entity-state>
  <mcsi:media>
    <entry label="main-audio">
      <type>audio</type>
      <status>sendrecv</status>
    </entry>
    <entry label="main-video">
      <type>video</type>
      <status>sendrecv</status>
      <mcsi:modal-parameters>
        <mcsi:video-parameters>
          <msav:video-mode>dominant-speaker-switched</msav:video-mode>
        </mcsi:video-parameters>
      </mcsi:modal-parameters>
    </entry>
    <entry label="panoramic-video">
      <type>panoramic-video</type>
      <status>sendrecv</status>
    </entry>
  </mcsi:media>
</mcsi:entity-state>
</mcsi:entity-view>
<mcsi:entity-view ci:state="full"
entity="sip:alice@fabrikam.com;gruu;opaque=app:conf:chat:id:5D3747C">
  <mcsi:entity-state>
    <mcsi:locked>false</mcsi:locked>
    <mcsi:media>
      <entry label="chat">
        <type>chat</type>
      </entry>
    </mcsi:media>
  </mcsi:entity-state>
</mcsi:entity-view>
<mcsi:entity-view ci:state="full"
entity="sip:alice@fabrikam.com;gruu;opaque=app:conf:meeting:id:5D3747C">
  <mcsi:entity-state application="27877e66-615c-4582-ab88-0cb2ca05d951">
    <mcsi:locked>false</mcsi:locked>
    <mcsi:media>
      <entry label="meeting">
        <type>meeting</type>
      </entry>
    </mcsi:media>
  </mcsi:entity-state>
</mcsi:entity-view>
<mcsi:entity-view ci:state="full" entity="sip:alice@fabrikam.com;gruu;opaque=app:conf:
applicationsharing:id:5D3747C ">

```



```

  <mcsi:entity-capabilities>
  <cis:separator/>
  <msas:capabilities>
  <msas:control-permission>ActiveDirectoryUsers</msas:control-permission>
  </msas:capabilities>
</mcsi:entity-capabilities>
<mcsi:entity-state>
<mcsi:locked>false</mcsi:locked>
<mcsi:media>

    <entry label="applicationsharing">
      <type>applicationsharing</type>
    </entry>

</mcsi:media>
</mcsi:entity-state>

```

```
</msci:entity-view>

</msci:conference-view>
</conference-info>
```

4.3.2 Terminating the Subscription

A participant terminates the subscription with the **focus** by sending a **SUBSCRIBE** request with an **Expires** header field with the value "0", as described in [RFC3265](#). A sample follows. The call flow is shown in the following figure.



Figure 11: Terminating the subscription

```
SUBSCRIBE sip:Alice@fabrikam.com;gruu;opaque=app:conf:focus:id:5D3747C SIP/2.0
From: <sip:bob@fabrikam.com>;tag=958d8a3fbc;epid=c5574cd6b6
To: <sip:Alice@fabrikam.com;gruu;opaque=app:conf:focus:id:5D3747C>;tag=0D440080
Via: SIP/2.0/TLS 10.1.2.50:4237
Max-Forwards: 70
Call-ID: 72d6a36a36784cf58e7e7ab1a51deca2
CSeq: 1 SUBSCRIBE
Contact: <sip:bob@fabrikam.com;opaque=user:epid:HT07tI-f3F-fdDyic8rblwAA;gruu>
User-Agent: UCCP/2.0.6362.0 OC/2.0.6362.0 (Microsoft Office Communicator)
Event: conference
Accept: application/conference-info+xml
Supported: com.microsoft.autoextend
Supported: ms-benotify
Proxy-Require: ms-benotify
Content-Length: 0
Expires: 0
Proxy-Authorization: NTLM qop="auth", realm="SIP Communications Service",
opaque="99052D67", crand="6475c82f", cnum="82", targetname="sip/ocs.fabrikam.com",
response="01000000e44de73c187afc887f8f5ef3"
```

The focus then sends a **200 OK** response.

```
SIP/2.0 200 OK
From: <sip:bob@fabrikam.com>;tag=958d8a3fbc;epid=c5574cd6b6
To: <sip:Alice@fabrikam.com;gruu;opaque=app:conf:focus:id:5D3747C>;tag=0D440080
Via: SIP/2.0/TLS 10.1.2.50:4237
Max-Forwards: 70
Call-ID: 72d6a36a36784cf58e7e7ab1a51deca2
CSeq: 1 SUBSCRIBE
Expires: 0
Contact: <sip:ocs.exchange.corp.fabrikam.com:5061;transport=tls>;isfocus
Authentication-Info: NTLM rspauth="01000000180D3416377238967F8F5EF3", srand="D6CD41F7",
snum="180", opaque="99052D67", qop="auth", targetname="sip/ocs.fabrikam.com", realm="SIP
Communications Service"
Content-Length: 0
```

4.4 Basic Conference Control

4.4.1 modifyConferenceLock

The current lock state of the **conference** is indicated in the conference roster in the **conference-view** container, as follows. In this example, there are three entities:

1. The **focus**.
2. The **Audio/Video Multipoint Control Unit (AVMCU)**.
3. The **IM MCU**.

Only the relevant code is shown. In this example, the AVMCU does not implement conference-locking, and hence does not report lock state in its **entity-view**. The focus and the IM MCU implement support for conference-locking and they report the current lock state in their respective **entity-view** sections.

```
<msci:conference-view ci:state="full">
  <msci:entity-view ci:state="full"
entity="sip:alice@fabrikam.com;gruu;opaque=app:conf:focus:id:5D3747C">
    <msci:entity-state>
      <msci:locked>>false</msci:locked>
    </msci:entity-state>
  </msci:entity-view>
  <msci:entity-view ci:state="full"
entity="sip:alice@fabrikam.com;gruu;opaque=app:conf:audio-video:id:5D3747C">
    <msci:entity-state>
      <!-- snipped -->
    </msci:entity-state>
  </msci:entity-view>
  <msci:entity-view ci:state="full"
entity="sip:alice@fabrikam.com;gruu;opaque=app:conf:chat:id:5D3747C">
    <msci:entity-state>
      <msci:locked>>false</msci:locked>
    </msci:entity-state>
  </msci:entity-view>
  <msci:entity-view ci:state="full"
entity="sip:alice@fabrikam.com;gruu;opaque=app:conf:applicationsharing:id:5D3747C">
    <msci:entity-state>
      <msci:locked>>false</msci:locked>
    </msci:entity-state>
  </msci:entity-view>
</msci:conference-view>
```

A presenter participant then sends a **modifyConferenceLock** command to lock the conference. The full call flow for that command is shown in the following figure. Note that the focus-to-MCU call flow is not shown in the following figure because it is outside the scope of this specification.

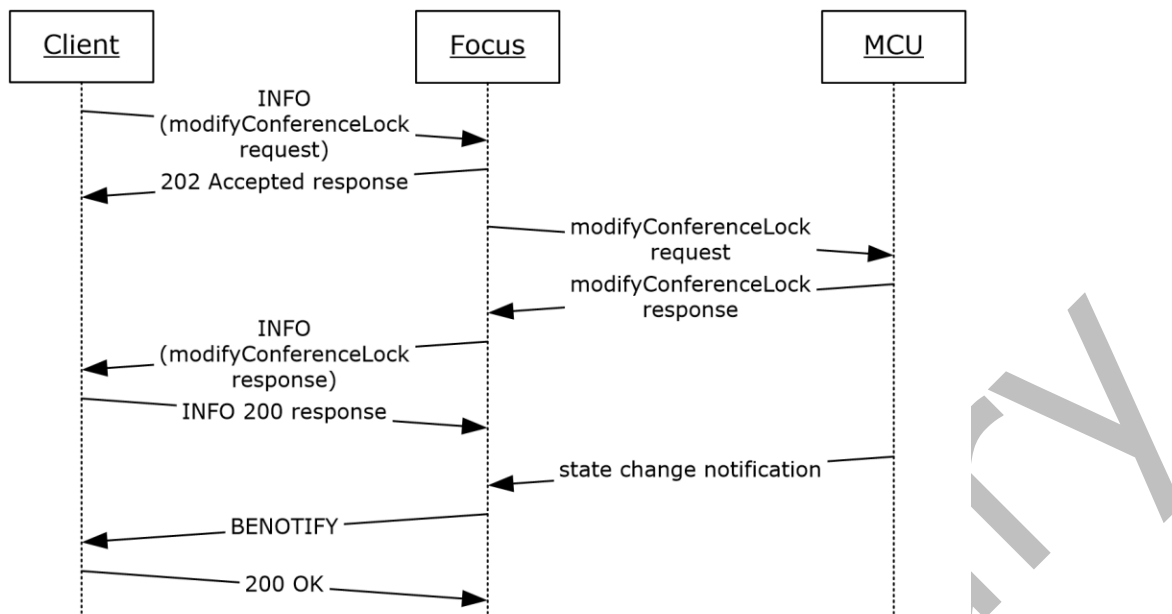

Figure 12: modifyConferenceLock call flow

The client sends a **modifyConferenceLock** request to the focus. In this example, Bob is a presenter who has the privileges to lock the conference.

```

INFO sip:Alice@fabrikam.com;gruu;opaque=app:conf:focus:id:5D3747C SIP/2.0
From: <sip:bob@fabrikam.com>;tag=958d8a3fbc;epid=c5574cd6b6
To: <sip:Alice@fabrikam.com;gruu;opaque=app:conf:focus:id:5D3747C>
Content-Type: application/cccp+xml
Content-Length: 736
Via: SIP/2.0/TLS 10.1.2.50:4237
Max-Forwards: 70
Call-ID: ad0da39085864c768630674f17692101
CSeq: 10 INFO
Contact: <sip:bob@fabrikam.com;opaque=user:epid:HT07tI-f3F-fdDyic8rblwAA;gruu>
User-Agent: UCCP/2.0.6362.0 OC/2.0.6362.0 (Microsoft Office Communicator)
Supported: timer
ms-keep-alive: UAC;hop-hop=yes
Proxy-Authorization: NTLM qop="auth", realm="SIP Communications Service",
opaque="99052D67", crand="6475c82f", cnum="82", targetname="sip/ocs.fabrikam.com",
response="01000000e44de73c187afc887f8f5ef3"
<request C3PVersion="1"
  to="sip:Alice@fabrikam.com;gruu;opaque=app:conf:focus:id:5D3747C "
  from="sip:bob@fabrikam.com" requestId="12"
  xmlns="urn:ietf:params:xml:ns:cccp"
  xmlns:ci="urn:ietf:params:xml:ns:conference-info">
  <modifyConferenceLock>
    <conferenceKeys
      confEntity="sip:alice@fabrikam.com;gruu;opaque=app:conf:focus:id:5D3747C"/>
    <locked>true</locked>
  <separator xmlns="urn:ietf:params:xml:ns:conference-info-separator" />
  <admission-policy>openAuthenticated</admission-policy>
  <autopromote>2147483648</autopromote>
    <pstn-lobby-bypass>>false</pstn-lobby-bypass>
  </modifyConferenceLock>
</request>
  
```

The focus validates the request and then responds with a **202 Accepted**, indicating that the command is being processed.

```
SIP/2.0 202 Accepted
From: <sip:bob@fabrikam.com>;tag=958d8a3fbc;epid=c5574cd6b6
To: <sip:Alice@fabrikam.com;gruu;opaque=app:conf:focus:id:5D3747C>
Via: SIP/2.0/TLS 10.1.2.50:4237
Max-Forwards: 70
Call-ID: ad0da39085864c768630674f17692101
CSeq: 10 INFO
Contact: <sip:ocs.exchange.corp.fabrikam.com:5061;transport=tls>;isfocus
Authentication-Info: NTLM rspauth="01000000180D3416377238967F8F5EF3", srand="D6CD41F7",
snum="180", opaque="99052D67", qop="auth", targetname="sip/ocs.fabrikam.com", realm="SIP
Communications Service"
Content-Length: 0
```

The focus applies the requested lock state and then sends a response, as follows.

```
INFO sip:10.54.78.109:4237;transport=tls;ms-opaque=6fb3a8330a;ms-received-
cid=10A0D00;grid SIP/2.0
To: <sip:bob@fabrikam.com>;tag=958d8a3fbc;epid=c5574cd6b6
From: <sip:Alice@fabrikam.com;gruu;opaque=app:conf:focus:id:5D3747C>
Content-Type: application/cccp+xml
Content-Length: 736
Via: SIP/2.0/TLS 10.1.2.50:4237
Max-Forwards: 70
Call-ID: ad0da39085864c768630674f17692101
CSeq: 50 INFO
Authentication-Info: NTLM rspauth="01000000180D3416377238967F8F5EF3", srand="D6CD41F7",
snum="180", opaque="99052D67", qop="auth", targetname="sip/ocs.fabrikam.com", realm="SIP
Communications Service"
<response requestId="12" C3PVersion="1"

from="sip:Alice@fabrikam.com;gruu;opaque=app:conf:focus:id:5D3747C"
  to="sip:bob@fabrikam.com"
  code="success"
  xmlns="urn:ietf:params:xml:ns:cccp"
  xmlns:ci="urn:ietf:params:xml:ns:conference-info">
  <modifyConferenceLock>
  <conference-info
entity="sip:alice@fabrikam.com;gruu;opaque=app:conf:focus:id:5D3747C"/>
  <locked>true</locked>
  <separator xmlns="urn:ietf:params:xml:ns:conference-info-separator" />
  <admission-policy>openAuthenticated</admission-policy>
  <autopromote>2147483648</autopromote>
  <pstn-lobby-bypass>false</pstn-lobby-bypass>
  </modifyConferenceLock>
</response>
```

The client responds with a **200 OK** to indicate that the INFO response was received.

```
SIP/2.0 200 OK
To: <sip:bob@fabrikam.com>;tag=958d8a3fbc;epid=c5574cd6b6
From: <sip:Alice@fabrikam.com;gruu;opaque=app:conf:focus:id:5D3747C>
Content-Length: 0
Via: SIP/2.0/TLS 10.1.2.50:4237
Max-Forwards: 70
Call-ID: ad0da39085864c768630674f17692101
CSeq: 50 INFO
Proxy-Authorization: NTLM qop="auth", realm="SIP Communications Service",
opaque="99052D67", crand="6475c82f", cnum="82", targetname="sip/ocs.fabrikam.com",
response="01000000e44de73c187afc887f8f5ef3"
```

All watchers receive a **notification** from the focus, indicating that the conference state has changed.

BENOTIFY sip:10.1.2.50:2383;transport=tls;ms-opaque=02e9aelf28;ms-received-cid=00031600;grid SIP/2.0
To: <sip:Alice@fabrikam.com>;tag=ccb81c3509;epid=c5574cd6b6
From: <sip:Alice@fabrikam.com;gruu;opaque=app:conf:focus:id:5D3747C>
Content-Length: 2373
Content-Type: application/conference-info+xml
Event: conference
Call-ID: 72d6a36a36784cf58e7e7ab1a51deca2
CSeq: 13 BENOTIFY
Authentication-Info: NTLM rspauth="01000000180D3416377238967F8F5EF3", srand="D6CD41F7", snum="180", opaque="99052D67", qop="auth", targetname="sip/ocs.fabrikam.com", realm="SIP Communications Service"
Max-Forwards: 70
Via: SIP/2.0/TLS 10.54.67.185:5061;branch=z9hG4bK86DA089F.780A7BCA;branched=FALSE
subscription-state: active;expires=3600

```
<conference-info xmlns="urn:ietf:params:xml:ns:conference-info"
  xmlns:mhci="http://schemas.fabrikam.com/rtc/2005/08/confinfoextensions"
  entity="sip:alice@fabrikam.com;gruu;opaque=app:conf:focus:id:5D3747C"
  state="partial" version="13">
  <mhci:conference-view ci:state="full">
    <mhci:entity-view ci:state="full"
      entity="sip:alice@fabrikam.com;gruu;opaque=app:conf:focus:id:5D3747C">
      <mhci:entity-state>
        <mhci:locked>true</mhci:locked>
      </mhci:entity-state>
    </mhci:entity-view>
    <mhci:entity-view ci:state="full"
      entity="sip:alice@fabrikam.com;gruu;opaque=app:conf:audio-video:id:5D3747C">
      <!-- snipped -->
    </mhci:entity-view>
    <mhci:entity-view ci:state="full"
      entity="sip:alice@fabrikam.com;gruu;opaque=app:conf:chat:id:5D3747C">
      <mhci:entity-state>
        <mhci:locked>>false</mhci:locked>
      <!-- snipped -->
    </mhci:entity-state>
  </mhci:entity-view>
</mhci:conference-view>
</conference-info>
```

The client receives a second notification from the focus, indicating that the IM MCU conference lock state has changed.

BENOTIFY sip:10.1.2.50:2383;transport=tls;ms-opaque=02e9aelf28;ms-received-cid=00031600;grid SIP/2.0
To: <sip:Alice@fabrikam.com>;tag=ccb81c3509;epid=c5574cd6b6
From: <sip:Alice@fabrikam.com;gruu;opaque=app:conf:focus:id:5D3747C>
Content-Length: 2373
Content-Type: application/conference-info+xml
Event: conference
Call-ID: 72d6a36a36784cf58e7e7ab1a51deca2
CSeq: 14 BENOTIFY
Authentication-Info: NTLM rspauth="01000000180D3416377238967F8F5EF3", srand="D6CD41F7", snum="180", opaque="99052D67", qop="auth", targetname="sip/ocs.fabrikam.com", realm="SIP Communications Service"
Max-Forwards: 70
Via: SIP/2.0/TLS 10.54.67.185:5061;branch=z9hG4bK86DA089F.780A7BCA;branched=FALSE
subscription-state: active;expires=3600

```
<conference-info xmlns="urn:ietf:params:xml:ns:conference-info"
  xmlns:mhci="http://schemas.fabrikam.com/rtc/2005/08/confinfoextensions"

  entity="sip:alice@fabrikam.com;gruu;opaque=app:conf:focus:id:5D3747C"
  state="partial" version="14">
  <mhci:conference-view ci:state="full">
```

```

    <msci:entity-view ci:state="full"
entity="sip:alice@fabrikam.com;gruu;opaque=app:conf:focus:id:5D3747C">
    <msci:entity-state>
    <msci:locked>true</msci:locked>
    </msci:entity-state>
  </msci:entity-view>
  <msci:entity-view ci:state="full"
entity="sip:alice@fabrikam.com;gruu;opaque=app:conf:audio-video:id:5D3747C">
    <!-- snipped -->
  </msci:entity-view>
  <msci:entity-view ci:state="full"
entity="sip:alice@fabrikam.com;gruu;opaque=app:conf:chat:id:5D3747C">
    <msci:entity-state">
    <msci:locked>true</msci:locked>
    <!-- snipped -->
  </msci:entity-state>
  </msci:entity-view>
</msci:conference-view>
</conference-info>

```

A **modifyConferenceLock** "otherFailure" response follows for illustrative purposes.

```

<modifyConferenceLock reason="otherFailure">
  <mscp:diagnostics-info>
    <mscp:entry>
      <mscp:key>ms-diagnostics-public</mscp:key>
      <mscp:value>3126;reason="Unauthorized - The user does not have the privilege for
the requested operation";source="ocs.fabrikam.com"
      </mscp:value>
    </mscp:entry>
  </mscp:diagnostics-info>
  <ci:conference-info entity="
sip:alice@fabrikam.com;gruu;opaque=app:conf:focus:id:5D3747C" />
  <locked>false</locked>

</modifyConferenceLock>

```

4.4.2 modifyUserRoles

The current role of a participant is reported in the conference roster in the **user** container, as follows.

```

<user entity="sip:cathy@fabrikam.com" state="full">
  <display-text>Cathy Baker</display-text>
  <roles>
    <entry>attende</entry>
  </roles>
  <!-- snipped -->
</user>

```

A presenter participant then sends a **modifyUserRoles** command to promote another participant. The full call flow for that command is shown in the following figure. Note that the focus-to-MCU call flow is not shown in the following figure because it is outside the scope of this specification.

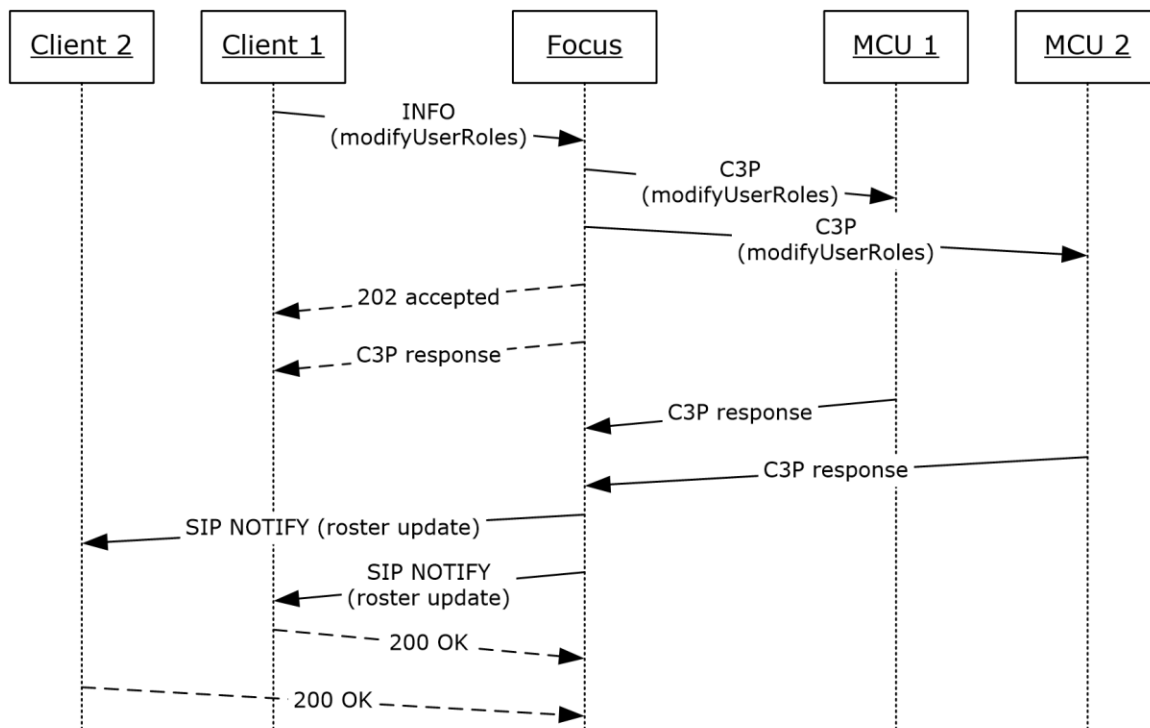

Figure 13: modifyUserRoles call flow

The client sends a **modifyUserRoles** request to the **focus**. In this example, Bob is a presenter who can promote other **conference** participants.

```

INFO sip:Alice@fabrikam.com;gruu;opaque=app:conf:focus:id:5D3747C SIP/2.0
From: <sip:bob@fabrikam.com>;tag=958d8a3fbc;epid=c5574cd6b6
To: <sip:Alice@fabrikam.com;gruu;opaque=app:conf:focus:id:5D3747C>
Content-Type: application/cccp+xml
Content-Length: 736
Via: SIP/2.0/TLS 10.1.2.50:4237
Max-Forwards: 70
Call-ID: ad0da39085864c768630674f17692101
CSeq: 11 INFO
Contact: <sip:bob@fabrikam.com;opaque=user:epid:HT07tI-f3F-fdDyic8rblwAA;gruu>
User-Agent: UCCP/2.0.6362.0 OC/2.0.6362.0 (Microsoft Office Communicator)
Supported: timer
ms-keep-alive: UAC;hop-hop=yes
Proxy-Authorization: NTLM gop="auth", realm="SIP Communications Service",
opaque="99052D67", crand="6475c82f", cnum="82", targetname="sip/ocs.fabrikam.com",
response="01000000e44de73c187afc887f8f5ef3"
  
```

```

<request C3PVersion="1"
  to="sip:Alice@fabrikam.com;gruu;opaque=app:conf:focus:id:5D3747C"
  from="sip:bob@fabrikam.com" requestId="13"
  xmlns="urn:ietf:params:xml:ns:cccp"
  xmlns:ci="urn:ietf:params:xml:ns:conference-info"
  xmlns:mcp="http://schemas.microsoft.com/rtc/2005/08/cccpextensions">
  <modifyUserRoles>
    <userKeys
      confEntity=
        "sip:alice@fabrikam.com;gruu;opaque=app:conf:focus:id:5D3747C"
      userEntity="sip:cathy@fabrikam.com"/>
    <user-roles xmlns="urn:ietf:params:xml:ns:conference-info">
      <entry>presenter</entry>
    </user-roles>
  </modifyUserRoles>
  
```

```
</request>
```

The focus validates the request and then responds with a **202 Accepted**, indicating that the command is being processed.

```
SIP/2.0 202 Accepted
From: <sip:bob@fabrikam.com>;tag=958d8a3fbc;epid=c5574cd6b6
To: <sip:Alice@fabrikam.com;gruu;opaque=app:conf:focus:id:5D3747C>
Via: SIP/2.0/TLS 10.1.2.50:4237
Max-Forwards: 70
Call-ID: ad0da39085864c768630674f17692101
CSeq: 11 INFO
Contact: <sip:ocs.exchange.corp.fabrikam.com:5061;transport=tls>;isfocus
Authentication-Info: NTLM rspauth="01000000180D3416377238967F8F5EF3", srand="D6CD41F7",
snum="180", opaque="99052D67", qop="auth", targetname="sip/ocs.fabrikam.com", realm="SIP
Communications Service"
Content-Length: 0
```

The focus applies the requested role and then sends a response, as follows.

```
INFO sip:10.54.78.109:4237;transport=tls;ms-opaque=6fb3a8330a;ms-received-
cid=10A0D00;grid SIP/2.0
To: <sip:bob@fabrikam.com>;tag=958d8a3fbc;epid=c5574cd6b6
From: <sip:Alice@fabrikam.com;gruu;opaque=app:conf:focus:id:5D3747C>
Content-Type: application/cccp+xml
Content-Length: 736
Via: SIP/2.0/TLS 10.1.2.50:4237
Max-Forwards: 70
Call-ID: ad0da39085864c768630674f17692101
CSeq: 51 INFO
Authentication-Info: NTLM rspauth="01000000180D3416377238967F8F5EF3", srand="D6CD41F7",
snum="180", opaque="99052D67", qop="auth", targetname="sip/ocs.fabrikam.com", realm="SIP
Communications Service"

<response requestId="13" C3PVersion="1"
from="sip:Alice@fabrikam.com;gruu;opaque=app:conf:focus:id:5D3747C"
to="sip:bob@fabrikam.com"
code="success"
xmlns="urn:ietf:params:xml:ns:cccp"
xmlns:ci="urn:ietf:params:xml:ns:conference-info"
xmlns:mscp="http://schemas.microsoft.com/rtc/2005/08/cccpextensions">
  <modifyUserRoles>
    <userKeys confEntity=
"sip:alice@fabrikam.com;gruu;opaque=app:conf:focus:id:5D3747C"
userEntity="sip:cathy@fabrikam.com"/>
    <roles xmlns="urn:ietf:params:xml:ns:conference-info">
      <entry>presenter</entry>
    </roles>
  </modifyUserRoles>
</response>
```

The client responds with a **200 OK** to the INFO request, which is not shown in the following example.

All watchers receive a **notification** from the focus, indicating that the user role has changed.

```
BENOTIFY sip:10.1.2.50:2383;transport=tls;ms-opaque=02e9aelf28;ms-received-
cid=00031600;grid SIP/2.0
To: <sip:Alice@fabrikam.com>;tag=ccb81c3509;epid=c5574cd6b6
From: <sip:Alice@fabrikam.com;gruu;opaque=app:conf:focus:id:5D3747C>
Content-Length: 2373
Content-Type: application/conference-info+xml
Event: conference
```

```
Call-ID: 72d6a36a36784cf58e7e7ab1a51deca2
CSeq: 15 BENOTIFY
Authentication-Info: NTLM rspauth="01000000180D3416377238967F8F5EF3", srand="D6CD41F7",
snum="180", opaque="99052D67", qop="auth", targetname="sip/ocs.fabrikam.com", realm="SIP
Communications Service"
Max-Forwards: 70
Via: SIP/2.0/TLS 10.54.67.185:5061;branch=z9hG4bK86DA089F.780A7BCA;branched=FALSE
subscription-state: active;expires=3600
```

```
<conference-info
  xmlns="urn:ietf:params:xml:ns:conference-info"
  xmlns:ci="urn:ietf:params:xml:ns:conference-info"
  entity="sip:alice@fabrikam.com;gruu;opaque=app:conf:focus:id:5D3747C"
  state="partial" version="16">
  <users state="partial">
    <user entity="sip:cathy@fabrikam.com" state="full">
      <display-text>Cathy Baker</display-text>
      <roles>
        <entry>presenter</entry>
      </roles>
      <!-- snipped -->
    </user>
  </users>

</conference-info>
```

4.4.3 deleteUser

The **deleteUser** command is sent by the client to the **focus** to delete the same or another participant from the **conference**.

In the following example, Client3 ejects Client2 from the conference. The following figure shows the call flow for this operation. Client3 is assumed to be a presenter who has the privileges to eject other conference participants. Client2 is assumed to be connected to the focus and MCU1. When the focus processes the **deleteUser** command, it terminates the **dialogs** with Client2 and then sends a **notification** to the watchers indicating that Client2 has left the focus. It also sends the **deleteUser** command to all of the **MCUs** in the conference.

The termination protocol between MCU1 and Client2 is not discussed because it is outside the scope of this specification. However, when Client2 leaves MCU1, MCU1 notifies the focus of that event. The focus then sends another notification to all watchers indicating that Client2 has left MCU1, which in effect means that Client2 is no longer connected to the conference, because it has already left the focus. In the following figure, the notifications from MCU2 to the focus are not shown for simplicity.

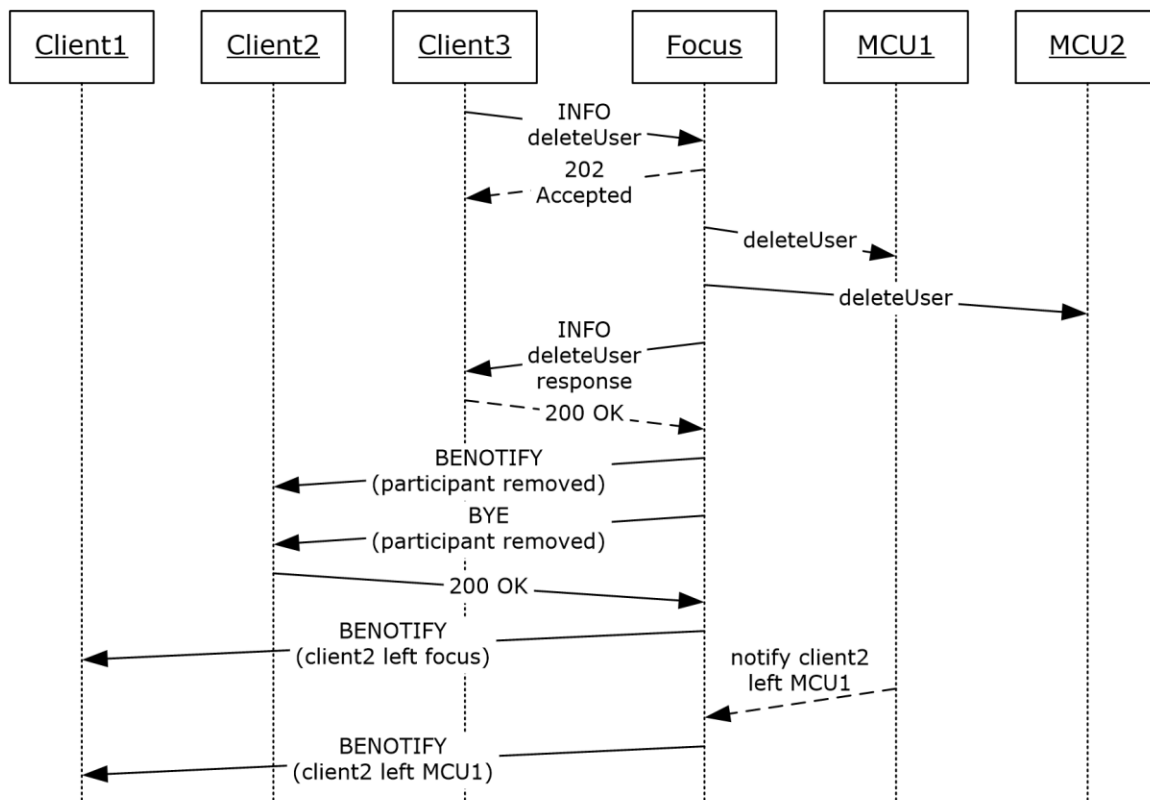

Figure 20: Ejecting a Participant from the conference

The client sends a **deleteUser** request to the focus.

```

INFO sip:Alice@fabrikam.com;gruu;opaque=app:conf:focus:id:5D3747C SIP/2.0
From: <sip:bob@fabrikam.com>;tag=958d8a3fbc;epid=c5574cd6b6
To: <sip:Alice@fabrikam.com;gruu;opaque=app:conf:focus:id:5D3747C>;tag=0D440080
Content-Type: application/cccp+xml
Content-Length: 736
Via: SIP/2.0/TLS 10.1.2.50:4237
Max-Forwards: 70
Call-ID: ad0da39085864c768630674f17692101
CSeq: 11 INFO
Contact: <sip:bob@fabrikam.com;opaque=user:epid:HT07tI-f3F-fdDyic8rblwAA;gruu>
User-Agent: UCCP/2.0.6362.0 OC/2.0.6362.0 (Microsoft Office Communicator)
Supported: timer
ms-keep-alive: UAC;hop-hop=yes
Proxy-Authorization: NTLM qop="auth", realm="SIP Communications Service",
opaque="99052D67", crand="6475c82f", cnum="82", targetname="sip/ocs.fabrikam.com",
response="01000000e44de73c187afc887f8f5ef3"
  
```

```

<request C3PVersion="1"
  to="sip:Alice@fabrikam.com;gruu;opaque=app:conf:focus:id:5D3747C"
  from="sip:bob@fabrikam.com" requestId="13"
  xmlns="urn:ietf:params:xml:ns:cccp"
  xmlns:ci="urn:ietf:params:xml:ns:conference-info">
  <deleteUser>
    <userKeys confEntity="sip:alice@fabrikam.com;gruu;opaque=app:conf:focus:id:5D3747C"
    userEntity entity="sip:cathy@fabrikam.com"/>
  </deleteUser>
</request>
  
```

The focus responds with a **202 Accepted**, which is not shown.

The focus terminates the subscription dialog with Cathy, as shown in the following example:

```
BENOTIFY sip:10.1.2.50:2383;transport=tls;ms-opaque=02e9aelf28;ms-received-
cid=00031600;grid SIP/2.0
To: <sip:cathy@fabrikam.com>;tag=ccb81c3509;epid=c5574cd6b6
From: <sip:Alice@fabrikam.com;gruu;opaque=app:conf:focus:id:5D3747C>;tag=0D440080
Content-Length: 0
Event: conference
Call-ID: 7d6a36a36784cf58e7e7ab1a51deca2
CSeq:100 BENOTIFY
Authentication-Info: NTLM rspauth="01000000180D3416377238967F8F5EF3", srand="D6CD41F7",
snum="180", opaque="99052D67", qop="auth", targetname="sip/ocs.fabrikam.com", realm="SIP
Communications Service"
Max-Forwards: 70
Via: SIP/2.0/TLS 10.54.67.185:5061;branch=z9hG4bK86DA089F.780A7BCA;branched=FALSE
subscription-state: terminated;expires=0;reason=ParticipantRemoved
```

The focus terminates the signaling dialog with Cathy, as shown in the following example:

```
BYE sip:131.107.0.72:30505;transport=tls;ms-opaque=83dce3c514;ms-received-
cid=FCA7300;gridSIP/2.0
To: <sip:cathy@fabrikam.com>;tag=958d8a3fbc;epid=c5574cd6b6
From: <sip:Alice@fabrikam.com;gruu;opaque=app:conf:focus:id:5D3747C>;tag=0D440080
Content-Length: 0
Via: SIP/2.0/TLS 10.1.2.50:4237
Max-Forwards: 70
Call-ID: ad0da39085864c768630674f17692101
CSeq: 12 BYE
Contact: <sip:bob@fabrikam.com;opaque=user:epid:HT07tI-f3F-fdDyic8rblwAA;gruu>
ms-diagnostics-public: 3118;reason="Participant Removed"
Reason: SIP;cause=481;text="Participant Removed"
Authentication-Info: NTLM rspauth="01000000180D3416377238967F8F5EF3", srand="D6CD41F7",
snum="180", opaque="99052D67", qop="auth", targetname="sip/ocs.fabrikam.com", realm="SIP
Communications Service"
```

The focus generates a notification to all watchers indicating that Cathy has left the focus. At this point, Cathy is still connected to the **IM MCU**.

```
BENOTIFY sip:10.1.2.50:2383;transport=tls;ms-opaque=02e9aelf28;ms-received-
cid=00031600;grid SIP/2.0
To: <sip:Alice@fabrikam.com>;tag=ccb81c3509;epid=c5574cd6b6
From: <sip:Alice@fabrikam.com;gruu;opaque=app:conf:focus:id:5D3747C>;tag=0D440080
Content-Length: 2373
Content-Type: application/conference-info+xml
Event: conference
Call-ID: 72d6a36a36784cf58e7e7ab1a51deca2
CSeq: 17 BENOTIFY
Authentication-Info: NTLM rspauth="01000000180D3416377238967F8F5EF3", srand="D6CD41F7",
snum="180", opaque="99052D67", qop="auth", targetname="sip/ocs.fabrikam.com", realm="SIP
Communications Service"
Max-Forwards: 70
Via: SIP/2.0/TLS 10.54.67.185:5061;branch=z9hG4bK86DA089F.780A7BCA;branched=FALSE
subscription-state: active;expires=3600

<conference-info
  xmlns="urn:ietf:params:xml:ns:conference-info"
  xmlns:msci="http://schemas.fabrikam.com/rtc/2005/08/confinfoextensions"
  xmlns:ci="urn:ietf:params:xml:ns:conference-info"
  entity="sip:alice@fabrikam.com;gruu;opaque=app:conf:focus:id:5D3747C"
  state="partial" version="17">
  <users state="partial">
    <user entity="sip:cathy@fabrikam.com" state="full">
```

```

    <display-text>Cathy Baker</display-text>
    <roles>
      <entry>presenter</entry>
    </roles>
    <endpoint entity="{9121CD6C-AFCC-4115-A5C4-089E4D17CCCE}" msci:session-type="chat"
msci:endpoint-uri="sip:cathy@fabrikam.com;opaque=user:epid:uWgzMWHhRViEC9LK-
xlgFAAA;gruu">
      <status>connected</status>
      <joining-method>dialled-in</joining-method>
      <!--snipped -->
    </endpoint>
  </user>
</users>
</conference-info>

```

The focus sends an INFO request back to the user with a **deleteUser** C3P response, which is not shown.

The focus sends the **deleteUser** request to all of the MCUs in the conference, which is not shown.

The IM MCU ejects the user from the conference, which is not shown.

The IM MCU sends a notification to the focus, indicating that the user has left the IM MCU, which is not shown.

The focus sends a notification to all watchers indicating that Cathy has left the conference, because Cathy is no longer connected to either the focus or to any MCU.

```

BENOTIFY sip:10.1.2.50:2383;transport=tls;ms-opaque=02e9aelf28;ms-received-
cid=00031600;grid SIP/2.0
To: <sip:Alice@fabrikam.com>;tag=ccb81c3509;epid=c5574cd6b6
From: <sip:Alice@fabrikam.com;gruu;opaque=app:conf:focus:id:5D3747C>;tag=0D440088
Content-Length: 2373
Content-Type: application/conference-info+xml
Event: conference
Call-ID: 72d6a36a36784cf58e7e7ab1a51deca2
CSeq: 18 BENOTIFY
Authentication-Info: NTLM rspauth="01000000180D3416377238967F8F5EF3", srand="D6CD41F7",
snum="180", opaque="99052D67", qop="auth", targetname="sip/ocs.fabrikam.com", realm="SIP
Communications Service"
Max-Forwards: 70
Via: SIP/2.0/TLS 10.54.67.185:5061;branch=z9hG4bK86DA089F.780A7BCA;branched=FALSE
subscription-state: active;expires=3600

<conference-info
  xmlns="urn:ietf:params:xml:ns:conference-info"
  xmlns:msci="http://schemas.fabrikam.com/rtc/2005/08/confinfoextensions"
  xmlns:ci="urn:ietf:params:xml:ns:conference-info"
  entity="sip:alice@fabrikam.com;gruu;opaque=app:conf:focus:id:5D3747C"
  state="partial" version="18">
  <users state="partial">
    <user entity="sip:cathy@fabrikam.com" state="deleted"/>
  </users>
</conference-info>

```

A **deleteUser** "otherFailure" response is given here for illustrative purposes.

```

<deleteUser reason="otherFailure">
  <mscp:diagnostics-info>
    <mscp:entry>
      <mscp:key>ms-diagnostics-public</mscp:key>
      <mscp:value>3126;reason="Unauthorized - The user does not have the privilege for
the requested operation";source="ocs.fabrikam.com"

```

```

    </mscp:value>
  </mscp:entry>
</mscp:diagnostics-info>
<conferenceKeys
confEntity="sip:alice@fabrikam.com;gruu;opaque=app:conf:focus:id:5D3747C" />
  <ci:user_entity="sip:cathy@fabrikam.com"/>
</deleteUser>

```

4.4.4 deleteConference

The **deleteConference** command is sent by the client to the **focus** to deactivate the **conference**.

In the following figure, Client3 decides to end the conference and sends a **deleteConference** command to the focus. The focus terminates the signaling and subscription **dialog** with all clients. The focus also sends the **deleteConference** command to all **MCUs** in the conference.

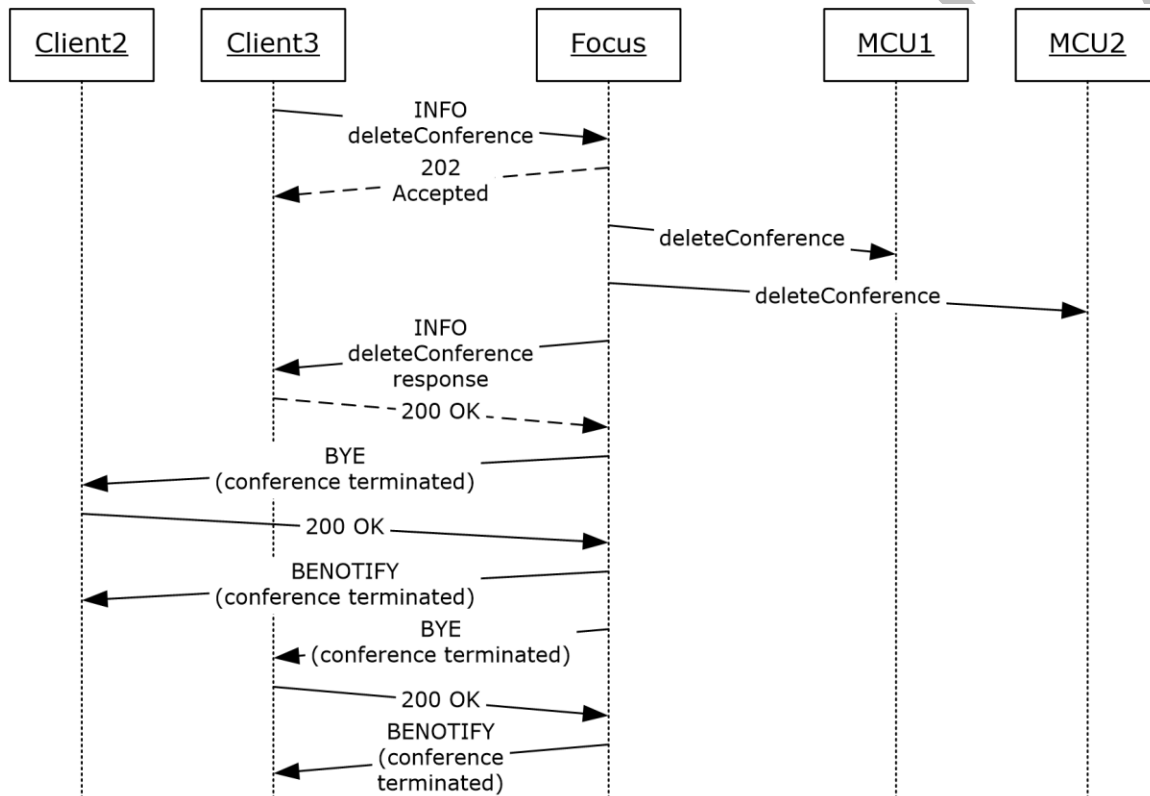

Figure 14: Terminating a conference

The client sends a **deleteConference** request to the focus.

```

INFO sip:Alice@fabrikam.com;gruu;opaque=app:conf:focus:id:5D3747C SIP/2.0
From: <sip:Alice@fabrikam.com>;tag=958d8a3fbc;epid=c5574cd6b6
To: <sip:Alice@fabrikam.com;gruu;opaque=app:conf:focus:id:5D3747C>;tag=0D440080
Content-Type: application/cccp+xml
Content-Length: 736
Via: SIP/2.0/TLS 10.1.2.50:4237
Max-Forwards: 70
Call-ID: ad0da39085864c768630674f17692101
CSeq: 11 INFO
Contact: <sip:alice@fabrikam.com;opaque=user:epid:HT07tI-f3F-fdDyic8rblwAA;gruu>

```

```
User-Agent: UCCP/2.0.6362.0 OC/2.0.6362.0 (Microsoft Office Communicator)
Supported: timer
ms-keep-alive: UAC;hop-hop=yes
Proxy-Authorization: NTLM qop="auth", realm="SIP Communications Service",
opaque="99052D67", crand="6475c82f", cnum="82", targetname="sip/ocs.fabrikam.com",
response="01000000e44de73c187afc887f8f5ef3"
```

```
<request C3PVersion="1"
  to="sip:Alice@fabrikam.com;gruu;opaque=app:conf:focus:id:5D3747C"
  from="sip:alice@fabrikam.com" requestId="13"
  xmlns="urn:ietf:params:xml:ns:cccp"
  xmlns:ci="urn:ietf:params:xml:ns:conference-info">
  <deleteConference>
    <ConferenceKeys
      confEntity="sip:alice@fabrikam.com;gruu;opaque=app:conf:focus:id:5D3747C"
    />
  </deleteConference>
</request>
```

The focus responds with a **202 Accepted**, which is not shown.

The focus terminates the invite dialog with every participant who is connected to the focus, as shown in the following example where the focus sends a BYE to Alice:

```
BYE sip:131.107.0.72:30505;transport=tls;ms-opaque=83dce3c514;ms-received-
cid=FCA7300;gridSIP/2.0
To: <sip:Alice@fabrikam.com>;tag=958d8a3fbc;epid=c5574cd6b6
From: <sip:Alice@fabrikam.com;gruu;opaque=app:conf:focus:id:5D3747C>;tag=0D440080
Content-Length: 0
Via: SIP/2.0/TLS 10.1.2.50:4237
Max-Forwards: 70
Call-ID: ad0da39085864c768630674f17692101
CSeq: 12 BYE
ms-diagnostics-public: 3116;reason="Conference Terminated - Organizer Ended Session"
Reason: SIP;cause=481;text="Conference Terminated - Organizer Ended Session"
```

The focus terminates the subscription dialog with every participant, as shown in the following example:

```
BENOTIFY sip:10.1.2.50:2383;transport=tls;ms-opaque=02e9aelf28;ms-received-
cid=00031600;grid SIP/2.0
To: <sip:Alice@fabrikam.com>;tag=ccb81c3509;epid=c5574cd6b6
From: <sip:Alice@fabrikam.com;gruu;opaque=app:conf:focus:id:5D3747C>;tag=0D440088
Content-Length: 2373
Content-Type: application/conference-info+xml
Event: conference
Call-ID: 72d6a36a36784cf58e7e7ab1a51deca2
CSeq: 18 BENOTIFY
Authentication-Info: NTLM rspauth="01000000180D3416377238967F8F5EF3", srand="D6CD41F7",
snum="180", opaque="99052D67", qop="auth", targetname="sip/ocs.fabrikam.com", realm="SIP
Communications Service"
Max-Forwards: 70
Via: SIP/2.0/TLS 10.54.67.185:5061;branch=z9hG4bK86DA089F.780A7BCA;branched=FALSE
subscription-state: terminated;expires=0;reason=ConferenceTerminated
ms-diagnostics-public: 3116;reason="Conference Terminated - Organizer Ended Session"
```

A **deleteConference** "otherFailure" response is given here for illustrative purposes.

```
<deleteConference reason="otherFailure">
  <mscp:diagnostics-info>
    <mscp:entry>
      <mscp:key>ms-diagnostics-public</mscp:key>
  </mscp:entry>
</deleteConference>
```



```

    <mscp:value>3126;reason="Unauthorized - The user does not have the privilege for
the requested operation";source="ocs.fabrikam.com"
    </mscp:value>
  </mscp:entry>
</mscp:diagnostics-info>
<conferenceKeys
confEntity="sip:alice@fabrikam.com;gruu;opaque=app:conf:focus:id:5D3747C" />
</deleteConference>

```

4.4.5 addUser Dial-out

The **addUser** dial-out command is used to connect a participant to an **MCU** by making the MCU invite the participant.

The detailed call flow is shown in the following figure.

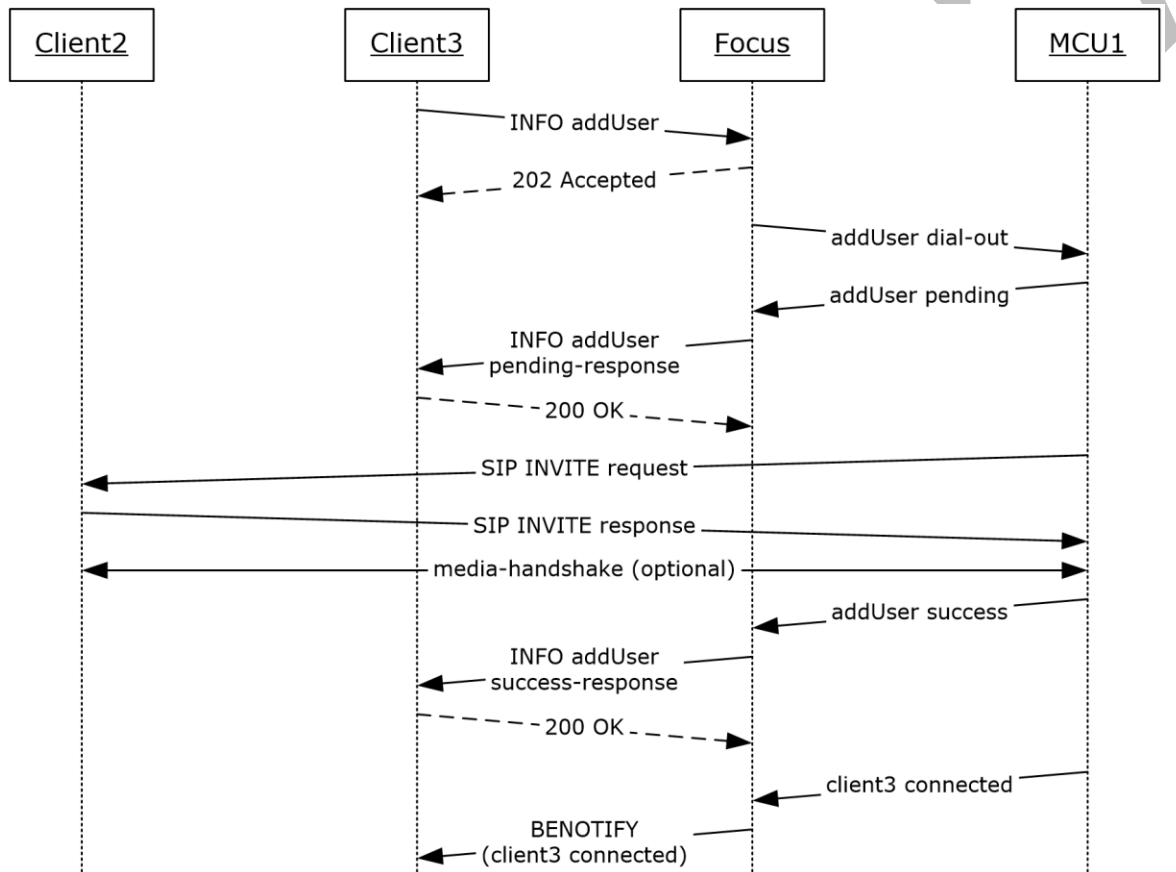

Figure 15: Connecting a Participant to an MCU

The client first sends an **addUser** dial-out request to the **focus**. In this example, MCU1 is an **IM MCU** with an **MCU-Conference-URI** with the value "sip:alice@fabrikam.com;gruu;opaque=app:conf:chat:id:5D3747C".

```

INFO sip:Alice@fabrikam.com;gruu;opaque=app:conf:focus:id:5D3747C SIP/2.0
From: <sip:bob@fabrikam.com>;tag=958d8a3fbc;epid=c5574cd6b6
To: <sip:Alice@fabrikam.com;gruu;opaque=app:conf:focus:id:5D3747C>;tag=0D440080
Content-Type: application/cccp+xml
Content-Length: 736

```

```

Via: SIP/2.0/TLS 10.1.2.50:4237
Max-Forwards: 70
Call-ID: ad0da39085864c768630674f17692101
CSeq: 12 INFO
Contact: <sip:bob@fabrikam.com;opaque=user:epid:HT07tI-f3F-fdDyic8rblwAA;gruu>
User-Agent: UCCP/2.0.6362.0 OC/2.0.6362.0 (Microsoft Office Communicator)
Supported: timer
ms-keep-alive: UAC;hop-hop=yes
Proxy-Authorization: NTLM qop="auth", realm="SIP Communications Service",
opaque="99052D67", crand="6475c82f", cnum="82", targetname="sip/ocs.fabrikam.com",
response="01000000e44de73c187afc887f8f5ef3"

<request C3PVersion="1"
  to="sip:Alice@fabrikam.com;gruu;opaque=app:conf:focus:id:5D3747C"
  from="sip:bob@fabrikam.com"
  requestId="14"xmlns="urn:ietf:params:xml:ns:cccp"
  xmlns:ci="urn:ietf:params:xml:ns:conference-info"
  xmlns:mscp="http://schemas.fabrikam.com/rtc/2005/08/cccpextensions"
  xmlns:msci="http://schemas.fabrikam.com/rtc/2005/08/confinfoextensions">

  <addUser
mscp:mcuUri="sip:alice@fabrikam.com;gruu;opaque=app:conf:chat:id:5D3747C">
  <conferenceKeys
confEntity="sip:alice@fabrikam.com;gruu;opaque=app:conf:focus:id:5D3747C"/>
  <user xmlns:ci="urn:ietf:params:xml:ns:conference-info"
entity="sip:cathy@fabrikam.com">
    <display-text>Cathy Baker</display-text>
    <roles>
      <entry>presenter</entry>
    </roles>
    <endpoint entity="{5CD3FC0A-05F7-4A17-A95B-430A28FC9EFA}"
msci:endpoint-uri="sip:cathy@fabrikam.com;opaque=user:epid:123;gruu">
      <joining-method>dialed-out</joining-method>
      <!-- other extension elements can follow -->
    </endpoint>
  </user>
</addUser>
</request>

```

The focus authorizes this request and forwards it to the IM MCU. The actual protocol used between the focus and the IM MCU is not shown here.

The focus also responds with a **202 Accepted** back to the client, which is not shown here.

In this example, the IM MCU sends a "pending" response to the focus. The actual protocol used between the IM MCU and the focus is not shown here.

The focus forwards the **addUser** "pending" response back to the client through the **SIP INFO** response, as shown in the following example:

```

INFO sip:10.54.78.109:4237;transport=tls;ms-opaque=6fb3a8330a;ms-received-
cid=10A0D00;grid SIP/2.0
To: <sip:bob@fabrikam.com>;tag=958d8a3fbc;epid=c5574cd6b6
From: <sip:Alice@fabrikam.com;gruu;opaque=app:conf:focus:id:5D3747C>;tag=0D440080
Content-Type: application/cccp+xml
Content-Length: 736
Via: SIP/2.0/TLS 10.1.2.50:4237
Max-Forwards: 70
Call-ID: ad0da39085864c768630674f17692101
CSeq: 52 INFO
Authentication-Info: NTLM rspauth="01000000180D3416377238967F8F5EF3", srand="D6CD41F7",
snum="180", opaque="99052D67", qop="auth", targetname="sip/ocs.fabrikam.com", realm="SIP
Communications Service"

<response requestId="14" C3PVersion="1"
  from="sip:Alice@fabrikam.com;gruu;opaque=app:conf:focus:id:5D3747C"

```

```

to="sip:bob@fabrikam.com"
code="pending"
xmlns="urn:ietf:params:xml:ns:cccp"
xmlns:ci="urn:ietf:params:xml:ns:conference-info"
responder="sip:alice@fabrikam.com;gruu;opaque=app:conf:chat:id:5D3747C ">
<!--valid addUser command body snipped -->
</response>

```

The client responds with a **200 OK** response to this INFO request, which is not shown.

The MCU then initiates an **INVITE** request to the client, which is constructed using the rules specified in section [3.10.4.1.1](#).

```

INVITE sip:cathy@fabrikam.com SIP/2.0
Via: SIP/2.0/TLS 10.1.2.50:4237
Max-Forwards: 70
From: <sip: Alice@fabrikam.com;gruu;opaque=app:conf:chat:id:5D3747C
>;tag=44f0d128a3;epid=492a7ce35f
To: <sip:cathy@fabrikam.com>
Call-ID: 79f76d701f1844e496e2c1e37a26c213
CSeq: 1 INVITE
<!-- other headers snipped -->
Content-Type: application/sdp
Content-Length: 203

<!-- media specific content body snipped -->

```

The client accepts the INVITE and responds with an INVITE 200 OK response, which is not shown. The response looks similar to regular 200 OK responses to INVITE requests, as described in [RFC3261](#).

The MCU successfully completes the handshake and then responds with a success response to the focus. The focus forwards the **addUser** success response back to the client through the SIP INFO response, as shown in the following example:

```

INFO sip:10.54.78.109:4237;transport=tls;ms-opaque=6fb3a8330a;ms-received-
cid=10A0D00;grid SIP/2.0
To: <sip:bob@fabrikam.com>;tag=958d8a3fbc;epid=c5574cd6b6
From: <sip:Alice@fabrikam.com;gruu;opaque=app:conf:focus:id:5D3747C>
Content-Type: application/cccp+xml
Content-Length: 736
Via: SIP/2.0/TLS 10.1.2.50:4237
Max-Forwards: 70
Call-ID: ad0da39085864c768630674f17692101
CSeq: 53 INFO
Authentication-Info: NTLM rspauth="01000000180D3416377238967F8F5EF3", srand="D6CD41F7",
snum="180", opaque="99052D67", qop="auth", targetname="sip/ocs.fabrikam.com", realm="SIP
Communications Service"
Content-Length: 0

<response requestId="14" C3PVersion="1"
  from="sip:Alice@fabrikam.com;gruu;opaque=app:conf:focus:id:5D3747C"
  to="sip:bob@fabrikam.com"
  code="success"
  xmlns="urn:ietf:params:xml:ns:cccp"
  xmlns:ci="urn:ietf:params:xml:ns:conference-info"
  responder="sip:alice@fabrikam.com;gruu;opaque=app:conf:chat:id:5D3747C ">
  <!-- valid addUser command body snipped -->
</response>

```

The MCU then sends a **notification** to the focus indicating that the user has connected. This notification is also generally referred to as a user-connected notification. The focus sends a notification to all the watchers with the user-connected state change, as shown in the following example:

```
BENOTIFY sip:10.1.2.50:2383;transport=tls;ms-opaque=02e9aelf28;ms-received-
cid=00031600;grid SIP/2.0
To: <sip:Alice@fabrikam.com>;tag=ccb81c3509;epid=c5574cd6b6
From: <sip:Alice@fabrikam.com;gruu;opaque=app:conf:focus:id:5D3747C>
Content-Length: 2373
Content-Type: application/conference-info+xml
Event: conference
Call-ID: 72d6a36a36784cf58e7e7ab1a51deca2
CSeq: 18 BENOTIFY
Authentication-Info: NTLM rspauth="01000000180D3416377238967F8F5EF3", srand="D6CD41F7",
snum="180", opaque="99052D67", qop="auth", targetname="sip/ocs.fabrikam.com", realm="SIP
Communications Service"
Max-Forwards: 70
Via: SIP/2.0/TLS 10.54.67.185:5061;branch=z9hG4bK86DA089F.780A7BCA;branched=FALSE
subscription-state: active;expires=3600
```

```
<conference-info
  xmlns="urn:ietf:params:xml:ns:conference-info"
  xmlns:msci="http://schemas.fabrikam.com/rtc/2005/08/confinfoextensions"
  xmlns:ci="urn:ietf:params:xml:ns:conference-info"
  entity="sip:alice@fabrikam.com;gruu;opaque=app:conf:focus:id:5D3747C"
  state="partial" version="18">
  <users state="partial">
    <user entity="sip:cathy@fabrikam.com" state="full">
      <!-- snipped -->
      <!-- new connected endpoint with the IM MCU - the focus stamps the session-type
attribute -->
      <endpoint entity="{5CD3FC0A-05F7-4A17-A95B-430A28FC9EFA}"
msci:session-type="chat"
msci:endpoint-uri="sip:cathy@fabrikam.com;opaque=user:epid:123;gruu">
        <joining-method>dialled-out</joining-method>
        <!-- other extension elements can follow -->
      </endpoint>
    </user>
  </users>
</conference-info>
```

4.4.6 addUser Dial-in

The **addUser** dial-in command is used to connect a participant to an **MCU**. Typically, the first step is conference signaling, using an **addUser** dial-in, and then MCU-specific signaling, such as an **INVITE** handshake, and finally MCU-specific media signaling. The detailed call flow is shown in the following figure.

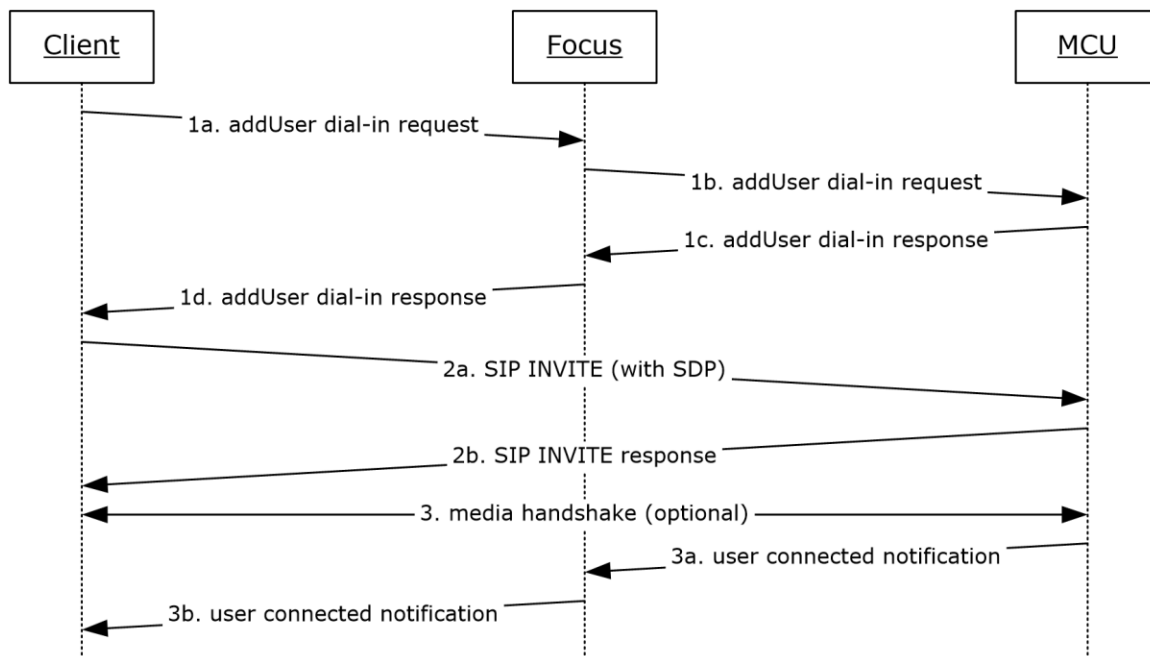

Figure 16: Connecting a Participant to an MCU

The client first sends an **addUser** dial-in request to the **focus**. In this example, the MCU is an **IM MCU** with an **MCU-Conference-URI** with the value "sip:alice@fabrikam.com;gruu;opaque=app:conf:chat:id:5D3747C".

```

INFO sip:Alice@fabrikam.com;gruu;opaque=app:conf:focus:id:5D3747C SIP/2.0
From: <sip:bob@fabrikam.com>;tag=958d8a3fbc;epid=c5574cd6b6
To: <sip:Alice@fabrikam.com;gruu;opaque=app:conf:focus:id:5D3747C>
Content-Type: application/cccp+xml
Content-Length: 736
Via: SIP/2.0/TLS 10.1.2.50:4237
Max-Forwards: 70
Call-ID: ad0da39085864c768630674f17692101
CSeq: 12 INFO
Contact: <sip:bob@fabrikam.com;opaque=user:epid:HT07tI-f3F-fdDyic8rblwAA;gruu>
User-Agent: UCCP/2.0.6362.0 OC/2.0.6362.0 (Microsoft Office Communicator)
Supported: timer
ms-keep-alive: UAC;hop-hop=yes
Proxy-Authorization: NTLM qop="auth", realm="SIP Communications Service",
opaque="99052D67", crand="6475c82f", cnum="82", targetname="sip/ocs.fabrikam.com",
response="01000000e44de73c187afc887f8f5ef3"

<request C3PVersion="1"
  to="sip:Alice@fabrikam.com;gruu;opaque=app:conf:focus:id:5D3747C"
  from="sip:bob@fabrikam.com" requestId="14"
  xmlns="urn:ietf:params:xml:ns:cccp"
  xmlns:ci="urn:ietf:params:xml:ns:conference-info"
  xmlns:mscp="http://schemas.fabrikam.com/rtc/2005/08/cccpextensions"
  xmlns:msci="http://schemas.fabrikam.com/rtc/2005/08/confinfoextensions">

  <addUser
    mscp:mcuUri="sip:alice@fabrikam.com;gruu;opaque=app:conf:chat:id:5D3747C">
    <conferenceKeys
      confEntity="sip:alice@fabrikam.com;gruu;opaque=app:conf:focus:id:5D3747C"/>
    <user xmlns:ci="urn:ietf:params:xml:ns:conference-info" entity="sip:bob@fabrikam.com">
      <display-text>Bob Baker</display-text>
      <roles>
        <entry>presenter</entry>
      </roles>
    </user>
  </addUser>
  
```

```

    <endpoint entity="{5CD3FC0A-05F7-4A17-A95B-430A28FC9EFA}"
msci:endpoint-uri="sip:bob@fabrikam.com;opaque=user:epid:123;gruu">
    <joining-method>dialed-in</joining-method>
    <!-- other extension elements can follow -->
  </endpoint>
</user>
</addUser>
</request>

```

The focus authorizes this request and forwards it to the IM MCU. The actual protocol used between the focus and the IM MCU is not shown here.

The focus also responds with a **202 Accepted** back to the client, which is not shown here.

The MCU responds to the **addUser** dial-in response, which is not shown here. The focus forwards the **addUser** success response back to the client through the **SIP** INFO response, as shown in the following example:

```

INFO sip:10.54.78.109:4237;transport=tls;ms-opaque=6fb3a8330a;ms-received-
cid=10A0D00;grid SIP/2.0
To: <sip:bob@fabrikam.com>;tag=958d8a3fbc;epid=c5574cd6b6
From: <sip:Alice@fabrikam.com;gruu;opaque=app:conf:focus:id:5D3747C>
Content-Type: application/cccp+xml
Content-Length: 736
Via: SIP/2.0/TLS 10.1.2.50:4237
Max-Forwards: 70
Call-ID: ad0da39085864c768630674f17692101
CSeq: 53 INFO
Authentication-Info: NTLM rspauth="01000000180D3416377238967F8F5EF3", srand="D6CD41F7",
snum="180", opaque="99052D67", qop="auth", targetname="sip/ocs.fabrikam.com", realm="SIP
Communications Service"

<response requestId="14" C3PVersion="1"
  from="sip:Alice@fabrikam.com;gruu;opaque=app:conf:focus:id:5D3747C"
  to="sip:bob@fabrikam.com"
  code="success"
  xmlns="urn:ietf:params:xml:ns:cccp"
  xmlns:ci="urn:ietf:params:xml:ns:conference-info"
  responder="sip:alice@fabrikam.com;gruu;opaque=app:conf:chat:id:5D3747C">

  <addUser>
    <conferenceKeys
confEntity="sip:alice@fabrikam.com;gruu;opaque=app:conf:focus:id:5D3747C"/>
    <user xmlns:ci="urn:ietf:params:xml:ns:conference-info"
entity="sip:bob@fabrikam.com">
      <display-text>Bob Baker</display-text>
      <roles>
        <entry>presenter</entry>
      </roles>
      <endpoint entity="{5CD3FC0A-05F7-4A17-A95B-430A28FC9EFA}"
msci:endpoint-uri="sip:bob@fabrikam.com;opaque=user:epid:123;gruu">
        <joining-method>dialed-in</joining-method>
        <!-- other extension elements can follow -->
      </endpoint>
    </user>

    <connection-info>
      <entry>
        <key>Mcu-Conference-Uri</key>
        <value>sip:alice@fabrikam.com;gruu;opaque=app:conf:chat:id:5D3747C</value>
      </entry>
      <entry>
        <key>Mcu-Server-Uri</key>
        <value>sip:chat.fabrikam.com:5061;transport=tls</value>
      </entry>
    </connection-info>

```

```
</addUser>

</response>
```

The client then initiates an INVITE request to the MCU using the rules specified in section [3.10.4.1.1](#). Specifically, it extracts the MCU-Conference-URI value from the **addUser** response and uses that value to construct the SIP **URIs** in the **To** and **Request-URI** header fields of the outgoing request.

```
INVITE :alice@fabrikam.com;gruu;opaque=app:conf:chat:id:5D3747C SIP/2.0
Via: SIP/2.0/TLS 10.1.2.50:4237
Max-Forwards: 70
From: <sip: bob@fabrikam.com>;tag=44f0d128a3;epid=492a7ce35f
To: <sip:alice@fabrikam.com;gruu;opaque=app:conf:chat:id:5D3747C >
Call-ID: 79f76d701f1844e496e2c1e37a26c213
CSeq: 1 INVITE
<!-- other headers snipped -->
Content-Type: application/sdp
Content-Length: 203

<!-- media specific content body snipped -->
```

The MCU accepts the INVITE request and then responds with a **200 OK**, which is not shown here.

The client and MCU then optionally perform media negotiation, if applicable, which is not shown here.

At the end of this handshake, the MCU sends a user-connected notification to the focus. The focus sends a notification to all the watchers with the user-connected state change, as shown in the following example:

```
BENOTIFY sip:10.1.2.50:2383;transport=tl;ms-opaque=02e9aelf28;ms-received-
cid=00031600;grid SIP/2.0
To: <sip:Alice@fabrikam.com>;tag=ccb81c3509;epid=c5574cd6b6
From: <sip:Alice@fabrikam.com;gruu;opaque=app:conf:focus:id:5D3747C>
Content-Length: 2373
Content-Type: application/conference-info+xml
Event: conference
Call-ID: 72d6a36a36784cf58e7e7ab1a51deca2
CSeq: 18 BENOTIFY
Authentication-Info: NTLM rspauth="01000000180D3416377238967F8F5EF3", srand="D6CD41F7",
snum="180", opaque="99052D67", qop="auth", targetname="sip/ocs.fabrikam.com", realm="SIP
Communications Service"
Max-Forwards: 70
Via: SIP/2.0/TLS 10.54.67.185:5061;branch=z9hg4bK86DA089F.780A7BCA;branched=FALSE
subscription-state: active;expires=3600

<conference-info
  xmlns="urn:ietf:params:xml:ns:conference-info"
  xmlns:mhci="http://schemas.fabrikam.com/rtc/2005/08/confinfoextensions"
  xmlns:ci="urn:ietf:params:xml:ns:conference-info"
  entity="sip:alice@fabrikam.com;gruu;opaque=app:conf:focus:id:5D3747C"
  state="partial" version="18">
  <users state="partial">
    <user entity="sip:bob@fabrikam.com" state="full">
      <!-- snipped -->
      <!-- new connected endpoint with the IM MCU - the focus stamps the session-type
attribute -->
      <endpoint entity="{5CD3FC0A-05F7-4A17-A95B-430A28FC9EFA}"
        mhci:session-type="chat"
        mhci:endpoint-uri="sip:bob@fabrikam.com;opaque=user:epid:123;gruu">
        <joining-method>dialled-out</joining-method>
        <!-- other extension elements can follow -->
      </endpoint>
    </user>
```

```
</users>
</conference-info>
```

4.4.7 getConference

The **getConference** command is sent by the client to the **focus** to retrieve the current active roster state of the **conference**.

Following is an example of a **getConference** request and a corresponding response. Note the response includes the encrypted conference key and web join **URLs**.

```
INFO sip:Alice@fabrikam.com;gruu;opaque=app:conf:focus:id:5D3747C SIP/2.0
From: <sip:bob@fabrikam.com>;tag=958d8a3fbc;epid=c5574cd6b6
To: <sip:Alice@fabrikam.com;gruu;opaque=app:conf:focus:id:5D3747C>
Content-Type: application/cccp+xml
Content-Length: 736
Via: SIP/2.0/TLS 10.1.2.50:4237
Max-Forwards: 70
Call-ID: ad0da39085864c768630674f17692101
CSeq: 12 INFO
Contact: <sip:bob@fabrikam.com;opaque=user:epid:HT07tI-f3F-fdDyic8rblwAA;gruu>
User-Agent: UCCP/2.0.6362.0 OC/2.0.6362.0 (Microsoft Office Communicator)
Supported: timer
ms-keep-alive: UAC;hop-hop=yes
Proxy-Authorization: NTLM qop="auth", realm="SIP Communications Service",
opaque="99052D67", crand="6475c82f", cnum="82", targetname="sip/ocs.fabrikam.com",
response="01000000e44de73c187afc887f8f5ef3"

<request C3PVersion="1"
  requestId="5"
  from="sip:alice@contoso.com"
  to="sip:alice@contoso.com;gruu;opaque=app:conf:focus:id:5D3747C "
  xmlns="urn:ietf:params:xml:ns:cccp"
  xmlns:misci="http://schemas.microsoft.com/rtc/2005/08/confinfoextensions">
  <getConference>
    <conferenceKeys
      confEntity="sip:alice@contoso.com;gruu;opaque=app:conf:focus:id:5D3747C" />
    <misci:encryption-key>
      <misci:x509-certificate>123213789BC234D</misci:x509-certificate>
    </misci:encryption-key>
  </getConference>
</request>

INFO sip:10.54.78.109:4237;transport=tls;ms-opaque=6fb3a8330a;ms-received-
cid=10A0D00;grid SIP/2.0
To: <sip:bob@fabrikam.com>;tag=958d8a3fbc;epid=c5574cd6b6
From: <sip:Alice@fabrikam.com;gruu;opaque=app:conf:focus:id:5D3747C>
Content-Type: application/cccp+xml
Content-Length: 736
Via: SIP/2.0/TLS 10.1.2.50:4237
Max-Forwards: 70
Call-ID: ad0da39085864c768630674f17692101
CSeq: 53 INFO
Authentication-Info: NTLM rspauth="01000000180D3416377238967F8F5EF3", srand="D6CD41F7",
snum="180", opaque="99052D67", qop="auth", targetname="sip/ocs.fabrikam.com", realm="SIP
Communications Service"

<response C3PVersion="1"
  requestId="5"
  from="sip:alice@fabrikam.com;gruu;opaque=app:conf:focus:id:5D3747C "
  to="sip:bob@fabrikam.com"
  code="success"
  xmlns="urn:ietf:params:xml:ns:cccp"
  xmlns="urn:ietf:params:xml:ns:conference-info"
```



```

xmlns:misci="http://schemas.fabrikam.com/rtc/2005/08/confinfoextensions"
xmlns:msim="http://schemas.fabrikam.com/rtc/2005/08/imconfinfoextensions"
xmlns:ci="urn:ietf:params:xml:ns:conference-info"
xmlns:cis="urn:ietf:params:xml:ns:conference-info-separator"
>
<getConference>
<conference-info
  entity="sip:alice@fabrikam.com;gruu;opaque=app:conf:focus:id:5D3747C"
  state="full" version="4">
<conference-description>
  <conf-uris>
    <entry>
      <uri>sip:alice@fabrikam.com;gruu;opaque=app:conf:chat:id:5D3747C</uri>
      <display-text>chat</display-text>
      <purpose>chat</purpose>
    </entry>
    <entry>
      <uri>sip:alice@fabrikam.com;gruu;opaque=app:conf:meeting:id:5D3747C</uri>
      <display-text>meeting</display-text>
      <purpose>meeting</purpose>
    </entry>
    <entry>
      <uri>sip:alice@fabrikam.com;gruu;opaque=app:conf:audio-video:id:5D3747C</uri>
      <display-text>audio-video</display-text>
      <purpose>audio-video</purpose>
    </entry>
    <entry>
      <uri>sip:alice@fabrikam.com;gruu;opaque=app:conf:applicationsharing:id:5D3747C</uri>
      <display-text>applicationsharing</display-text>
      <purpose>applicationsharing</purpose>
    </entry>
  </conf-uris>
  <ci:entry>
    <ci:uri>http://schemas.microsoft.com/2008/05/confxmlenc#content</ci:uri>
    <ci:purpose>web-internal</ci:purpose>
    <cis:separator/>
    <misci:encrypted-uri>
      <misci:cms-data>MIIBXQYJKoZIhvcNAQcDoIIBtjCCAbICAQAxgd0wgdoCAQAwwQzAvMS0wKwYDVQQD
      HiQAVQBDAAEMAUAbfAEMATwBOAEYAXwBNAEcAUgBfAEMARQBSAFQCEJZ158V5VBmQ
      TbGUrNBQKJIwDQYJKoZIhvcNAQEBBQAEgYAF3rI5FWWEDcrrxJGS93WC3HC4YlmQ
      +D/Ti6cICFX0opLmIwwwoWlIkBAj0b8/HAWxmHjns2LrOafkvdDB9s0TJF7Bhl0f
      v9L5PYZmj4DhtJqYiN0SxHssSPsdWBi/JYNlno4erqeLEkRiJh5P8mz0Xtoo00b
      zgrMNVpf+woSlTCBzAYJKoZIhvcNAQcBMBQGcCqGSIb3DQMHBAGF+wlt0hvIROCB
      qLTZ/YMC/7B2pF+V6oBpwo66uJRh6MseJFHbdWT8ptJVx9wJ5jUjFP51fP+vgIKd
      eX8ArVxfFwZJD4Kynzfd/0gQjZMLR90GHhyNimbeehrWuPwli+G14n0s+tejJjS
      mf8t9oUSEKHxoljcyak/fptHFxpp4W0sXa5QRlXcaw6FLIJGdPclVArRw1Bkaxx+
      n+f320/lwBAq2TT2MfRlgW9qzc3sPekOrw==
    </misci:cms-data>
    </misci:encrypted-uri>
  </ci:entry>
  <ci:entry>
    <ci:uri>http://schemas.microsoft.com/2008/05/confxmlenc#content</ci:uri>
    <ci:purpose>web-external</ci:purpose>
    <cis:separator/>
    <misci:encrypted-uri>
      <misci:cms-data>MIIBXQYJKoZIhvcNAQcDoIIBtjCCAbICAQAxgd0wgdoCAQAwwQzAvMS0wKwYDVQQD
      HiQAVQBDAAEMAUAbfAEMATwBOAEYAXwBNAEcAUgBfAEMARQBSAFQCEJZ158V5VBmQ
      TbGUrNBQKJIwDQYJKoZIhvcNAQEBBQAEgYCaFGVjZW/VHnfp23SzJAuW/Q90nkfB
      +qbwTsh6RBkz3kX9yzFIrZsU+2R7z+nd3JcvTkJw/mmKxTaKRZksEDwbQgT/kg/V
      4Fwx/XRQP9mFI+m6YnY56jgnwTiG97CLNNe+/1tJtjy/h4cFn51fvoz5eZXPC8MO
      Ls75p7hXLPdemTCBzAYJKoZIhvcNAQcBMBQGcCqGSIb3DQMHBAGF+wlt0hvIROCB
      qBhSEZ5JbWkQ0dLYq8pcK/tbYHfODpwUcDAglG0grpVWjHmzm6gmGMURlfQ4X5Y
      4wYpamBqfR5XDe6MP+99gpxdAelXTgUKE2/unwAr1pn69BgeiceZlX7kCV748wU6
      P7ou0zbKbbLqRGED00MXmEwuWSJMacVdo94WkdNKie8cyFt9Q5d0CRlvtvG870T2
      YOIlxotrcyNwxbJUATHDMjC3+TMaq5UAPg==
    </misci:cms-data>
    </misci:encrypted-uri>
  </ci:entry>

```

```

    </conf-uris>
<msci:conference-key>
<msci:cms-data>MIIBGwYJKoZIhvcNAQcDoIIBDDCCAQgCAQAxgd0wgdoCAQAwQzAvMS0wKwYDVQQD
HiQAVQBDAEMAUABfAEMATwBOAEYAXwBNAEcaUgBfAEMARQBSAFQCEHnE9LxZvvyH
Sz3dZuY7xq4wDQYJKoZIhvcNAQEBBQAEgYATbyHXHUnm0kqBO5T7vbhkPTnx8eVJ
YAa00Bid9dh7MwOWhC27pffS83ZwLaZVHsSxAUUR5h0Weq+TU5W+7V1ZaTLYaxHF
jh3qElBX9gSf+KPRKTde2tCnP2FcJL2Ksn20P2tt0mXgBmnrF20niJxmjY0280
qt4UURxU7M5eFzAjBgkqhkiG9w0BBwEwFAYIKoZIhvcNAwcECP++R9m7uH9QgAA=
</msci:cms-data>
</msci:conference-key>

<cis:separator/>
<msci:pstn-access>
<msci:id>37890</msci:id>
</msci:pstn-access>

</conference-description>
  <users state="full">
    <user entity="sip:alice@fabrikam.com" state="full">
      <display-text>Alice Gates</display-text>
      <roles>
        <entry>presenter</entry>
      </roles>
      <endpoint entity="{09AA504C-BA41-4458-8669-8F35470F6CA2}" msci:session-
type="focus" msci:endpoint-uri="sip:alice@fabrikam.com;opaque=user:epid:HT07tI-f3F-
fdDyic8rblwAA;gruu">
        <status>connected</status>
      </endpoint>
    </user>
  </users>

  <msci:conference-view ci:state="full">
    <msci:entity-view ci:state="full"
entity="sip:alice@fabrikam.com;gruu;opaque=app:conf:focus:id:5D3747C">
      <msci:entity-state>
        <msci:locked>>false</msci:locked>
      </msci:entity-state>
    </msci:entity-view>
    <msci:entity-view ci:state="full"
entity="sip:alice@fabrikam.com;gruu;opaque=app:conf:audio-video:id:5D3747C">
      <msci:entity-capabilities>
        <msav:capabilities>
          <msav:supports-audio>>true</msav:supports-audio>
          <msav:supports-video>>true</msav:supports-video>
        </msav:capabilities>
      </msci:entity-capabilities>
      <msci:entity-state>
        <msci:media>
          <entry label="main-audio">
            <type>audio</type>
            <status>sendrecv</status>
          </entry>
          <entry label="main-video">
            <type>video</type>
            <status>sendrecv</status>
            <msci:modal-parameters>
              <msci:video-parameters>
                <msav:video-mode>dominant-speaker-switched</msav:video-mode>
              </msci:video-parameters>
            </msci:modal-parameters>
          </entry>
          <entry label="panoramic-video">
            <type>panoramic-video</type>
            <status>sendrecv</status>
          </entry>
        </msci:media>
      </msci:entity-state>
    </msci:entity-view>

```

```

    <msci:entity-view ci:state="full"
entity="sip:alice@fabrikam.com;gruu;opaque=app:conf:chat:id:5D3747C">
    <msci:entity-state>
    <msci:locked>false</msci:locked>
    <msci:media>
    <entry label="chat">
    <type>chat</type>
    </entry>
    </msci:media>
    </msci:entity-state>
    </msci:entity-view>
    <msci:entity-view ci:state="full"
entity="sip:alice@fabrikam.com;gruu;opaque=app:conf:meeting:id:5D3747C">
    <msci:entity-state application="27877e66-615c-4582-ab88-0cb2ca05d951">
    <msci:locked>false</msci:locked>
    <msci:media>
    <entry label="meeting">
    <type>meeting</type>
    </entry>
    </msci:media>
    </msci:entity-state>
    </msci:entity-view>
    <msci:entity-view ci:state="full"
entity="sip:alice@fabrikam.com;gruu;opaque=app:conf:applicationsharing:id:5D3747C ">
    <msci:entity-capabilities>
    <cis:separator/>
    <msas:capabilities>
    <msas:control-permission>ActiveDirectoryUsers</msas:control-permission>
    </msas:capabilities>
    </msci:entity-capabilities>
    <msci:entity-state>
    <msci:locked>false</msci:locked>
    <msci:media>
    <entry label="applicationsharing">
    <type>applicationsharing</type>
    </entry>
    </msci:media>
    </msci:entity-state>
    </msci:entity-view>
    </msci:conference-view>
    </conference-info>
    </getConference>
</response>

```

4.4.8 setLobbyAccess

The **setLobbyAccess** command is sent by the client to the **focus** to admit users from the **lobby** into the **conference** or to eject users out of the lobby.

Following is an example of a **setLobbyAccess** request and a corresponding response.

The client sends a **setLobbyAccess** request to the focus to admit Bob into the conference. In this example, Bob is a presenter who has the privileges to lock the conference.

```

INFO sip:alice@fabrikam.com;gruu;opaque=app:conf:focus:id:SI1NZFAU SIP/2.0
FROM: <sip:alice@fabrikam.com>;epid=C740CAEB6;tag=3d98c7859
TO: <sip:alice@fabrikam.com;gruu;opaque=app:conf:focus:id:SI1NZFAU>;tag=F16D0080
CSEQ: 7 INFO
CALL-ID: 1aff74e7-cfc1-4618-93f1-8367bf6fff461
MAX-FORWARDS: 70
VIA: SIP/2.0/TLS 157.56.65.217:3221;branch=z9hG4bK7185d26c
AUTHORIZATION: Kerberos realm="SIP Communications
Service",targetname="sip/ocs.fabrika..com",response="040400ffffffffff0000000000000000eac97e53
b2595c3602614fea",crand="0a0ff851",cnum="11",opaque="F7BE5261",qop="auth"

```

```
CONTACT: <sip:alice@fabrikam.com;opaque=user:epid:-30_9AUDMF-
qNGIrfd9GqwAA;gruu>;text;audio;video;image
CONTENT-LENGTH: 689
SUPPORTED: gruu-10
USER-AGENT: RTCC/4.0.0.0 AgentForCollaborationTests
CONTENT-TYPE: application/cccp+xml
<request xmlns:xsi="http://www.w3.org/2001/XMLSchema-instance"
xmlns:xsd="http://www.w3.org/2001/XMLSchema"
  requestId="5" C3PVersion="1"
  from="sip:alice@fabrikam.com"
  to="sip:alice@fabrikam.com;gruu;opaque=app:conf:focus:id:SI1NZFAU"
  xmlns="urn:ietf:params:xml:ns:cccp">
  <setLobbyAccess>
    <conferenceKeys confEntity="sip:alice@fabrikam.com;gruu;opaque=app:conf:focus:id:SI1NZFAU"
  />
  <userEntity>sip:bob@fabrikam.com</userEntity>
  <access>granted</access>
</setLobbyAccess>
</request>
```

The focus validates the request and then responds with a **202 Accepted**, indicating that the command is being processed.

```
SIP/2.0 202 Accepted
FROM: <sip:alice@fabrikam.com>;epid=C740CAAEB6;tag=3d98c7859
TO:<sip:alice@fabrikam.com;gruu;opaque=app:conf:focus:id:SI1NZFAU>;tag=F16D0080
Via: SIP/2.0/TLS 10.1.2.50:4237
Max-Forwards: 70
Call-ID: 1aff74e7-cfc1-4618-93f1-8367bf6ff461
CSeq: 10 INFO
Contact: <sip:ocs.exchange.corp.fabrikam.com:5061;transport=tls>;isfocus
Authentication-Info: NTLM rspauth="01000000180D3416377238967F8F5EF3",
srand="D6CD41F7", snum="180", opaque="99052D67", qop="auth",
targetname="sip/ocs.fabrikam.com", realm="SIP Communications Service"
Content-Length: 0
```

The focus admits Bob and then sends a response, as shown in the following example:

```
INFO sip:10.54.78.109:4237;transport=tls;ms-opaque=6fb3a8330a;ms-received-cid=10A0D00;grid
SIP/2.0

FROM: <sip:alice@fabrikam.com;gruu;opaque=app:conf:focus:id:SI1NZFAU>;tag=F16D0080
TO: <sip:alice@fabrikam.com>;tag=3d98c7859;epid=C740CAAEB6
CSEQ: 1158 INFO
CALL-ID: 1aff74e7-cfc1-4618-93f1-8367bf6ff461
MAX-FORWARDS: 70
VIA: SIP/2.0/TLS 172.24.32.150:5061;branch=z9hG4bK03B71C21.61B8433131093661;branched=FALSE
CONTENT-LENGTH: 1591
SUPPORTED: ms-dialog-route-set-update
CONTENT-TYPE: application/cccp+xml
AUTHENTICATION-INFO: Kerberos qop="auth", opaque="F7BE5261", srand="E52E9F9F", snum="14",
rspauth="040401ffffffffff00000000000000000041f3545d7770711ff3227c6e",
targetname="sip/ocs.fabrikam.com", realm="SIP Communications Service", version=4
<response xmlns="urn:ietf:params:xml:ns:cccp"
xmlns:msacp="http://schemas.microsoft.com/rtc/2005/08/acpconfinfoextensions"
xmlns:msas="http://schemas.microsoft.com/rtc/2005/08/asconfinfoextensions"
xmlns:tns="http://schemas.microsoft.com/rtc/2005/08/avconfinfoextensions"
xmlns:mscp="http://schemas.microsoft.com/rtc/2005/08/cccpextensions"
xmlns:msci="http://schemas.microsoft.com/rtc/2005/08/confinfoextensions"
xmlns:msdata="http://schemas.microsoft.com/rtc/2005/08/dataconfinfoextensions"
xmlns:msim="http://schemas.microsoft.com/rtc/2005/08/imconfinfoextensions"
xmlns:msci2="http://schemas.microsoft.com/rtc/2008/12/confinfoextensions"
xmlns:msmcu="http://schemas.microsoft.com/rtc/2009/03/commonmcuextensions"
xmlns:ci="urn:ietf:params:xml:ns:conference-info"
```

```

xmlns:cis="urn:ietf:params:xml:ns:conference-info-separator"
xmlns:msls="urn:ietf:params:xml:ns:msls" requestId="5" C3PVersion="1"
from="sip:alice@fabrikam.com;gruu;opaque=app:conf:focus:id:SI1NZFAU"
to="sip:alice@fabrikam.com" code="success">
<setLobbyAccess>
<conferenceKeys confEntity="sip:alice@fabrikam.com;gruu;opaque=app:conf:focus:id:SI1NZFAU"/>
<status reason="success">
<userEntity>sip:bob@fabrikam.com</userEntity>
</status>
</setLobbyAccess>
</response>

```

The client responds with a **200 OK** to indicate that the INFO response was received.

```

SIP/2.0 200 OK
TO: <sip:alice@fabrikam.com>;epid=C740CAAEB6;tag=3d98c7859
FROM:<sip:alice@fabrikam.com;gruu;opaque=app:conf:focus:id:SI1NZFAU>;tag=F16D0080
Via: SIP/2.0/TLS 10.1.2.50:4237
Max-Forwards: 70
Call-ID: laff74e7-cfc1-4618-93f1-8367bf6ff461
CSeq: 10 INFO
Contact: <sip:ocs.exchange.corp.fabrikam.com:5061;transport=tls>;isfocus
Authentication-Info: NTLM rspauth="01000000180D3416377238967F8F5EF3",
srand="D6CD41F7", snum="180", opaque="99052D67", qop="auth",
targetname="sip/ocs.fabrikam.com", realm="SIP Communications Service"
Content-Length: 0

```

All watchers receive a **notification** from the focus, indicating that Bob was admitted to the conference and that Cathy was ejected.

```

BENOTIFY sip:10.1.2.50:2383;transport=tls;ms-opaque=02e9aelf28;ms-received-cid=00031600;grid
SIP/2.0
To: <sip:alice@fabrikam.com>;epid=C740CAAEB6;tag=3d98c7859
From: <sip:Alice@fabrikam.com;gruu;opaque=app:conf:focus:id:SI1NZFAU>
Content-Length: 2373
Content-Type: application/conference-info+xml
Event: conference
Call-ID: 72d6a36a36784cf58e7e7ab1a51deca2
CSeq: 4 BENOTIFY
Authentication-Info: NTLM rspauth="01000000180D3416377238967F8F5EF3", srand="D6CD41F7",
snum="180", opaque="99052D67", qop="auth", targetname="sip/ocs.fabrikam.com", realm="SIP
Communications Service"
Max-Forwards: 70
Via: SIP/2.0/TLS 10.54.67.185:5061;branch=z9hG4bK86DA089F.780A7BCA;branched=FALSE
subscription-state: active;expires=3600

<conference-info xmlns="urn:ietf:params:xml:ns:conference-info"
  xmlns:msci="http://schemas.fabrikam.com/rtc/2005/08/confinfoextensions"
  xmlns:msim="http://schemas.fabrikam.com/rtc/2005/08/imconfinfoextensions"
  xmlns:ci="urn:ietf:params:xml:ns:conference-info"
  xmlns:cis="urn:ietf:params:xml:ns:conference-info-separator"
  entity="sip:alice@fabrikam.com;gruu;opaque=app:conf:focus:id:SI1NZFAU"
  state="partial" version="8">
  <users state="partial">
    <user entity="sip:bob@fabrikam.com" state="full">
      <display-text>Bob</display-text>
      <roles>
        <entry>presenter</entry>
      </roles>
      <endpoint entity="{09AA504C-BA41-4458-8669-8F35470F6CA2}" msci:session-type="focus"
msci:endpoint-uri="sip:bob@fabrikam.com;opaque=user:epid:HT07tI-f3F-fdDyic8rblwAA;gruu">
        <status>connected</status>
      </endpoint>
    </user>
  </users>

```

</conference-info>

Assume that Cathy was also a lobby participant, but was denied access into the conference by Alice. Cathy receives a BYE, as shown in the following example:

```
BENOTIFY sip:10.1.2.50:2383;transport=tls;ms-opaque=02e9aelf28;ms-received-cid=00031600;grid
SIP/2.0
FROM: < sip:Alice@fabrikam.com;gruu;opaque=app:conf:focus:id:SI1NZFAU>
>;tag=47150080
TO: < sip:cathy@fabrikam.com>;tag=cec49c86e1;epid=732A323248
CSEQ: 2 BENOTIFY
CALL-ID: 5a749d9794cb4639ab290033b9332a57
MAX-FORWARDS: 70
VIA: SIP/2.0/TLS 172.24.32.150:5061;branch=z9hG4bKDDA0E5C6.F0433D83D36FE063;branched=FALSE
CONTENT-LENGTH: 0
EVENT: conference
EXPIRES: 0
SUBSCRIPTION-STATE: terminated;expires=0;reason=ParticipantDenied
AUTHENTICATION-INFO: Kerberos qop="auth", opaque="D211BAF4", srand="0F7C511D", snum="7",
rspauth="040401ffffffff000000000000000000000008b2eea6f1b43bd4abe390a9",
targetname="sip/ocs.fabrikam.com", realm="SIP Communications Service", version=4
ms-diagnostics-public: 3119;reason="Participant Denied"
```

4.4.9 modifyEndpoint

The **modifyEndpoint** command is sent by the client to the **focus** to modify the **endpoint** extensions between the **addUser** command and the **deleteUser** command. The **confEntity**, **user** entity and **endpoint** entity have already communicated with focus in the **addUser** command. The detailed call flow is shown in the following figure.

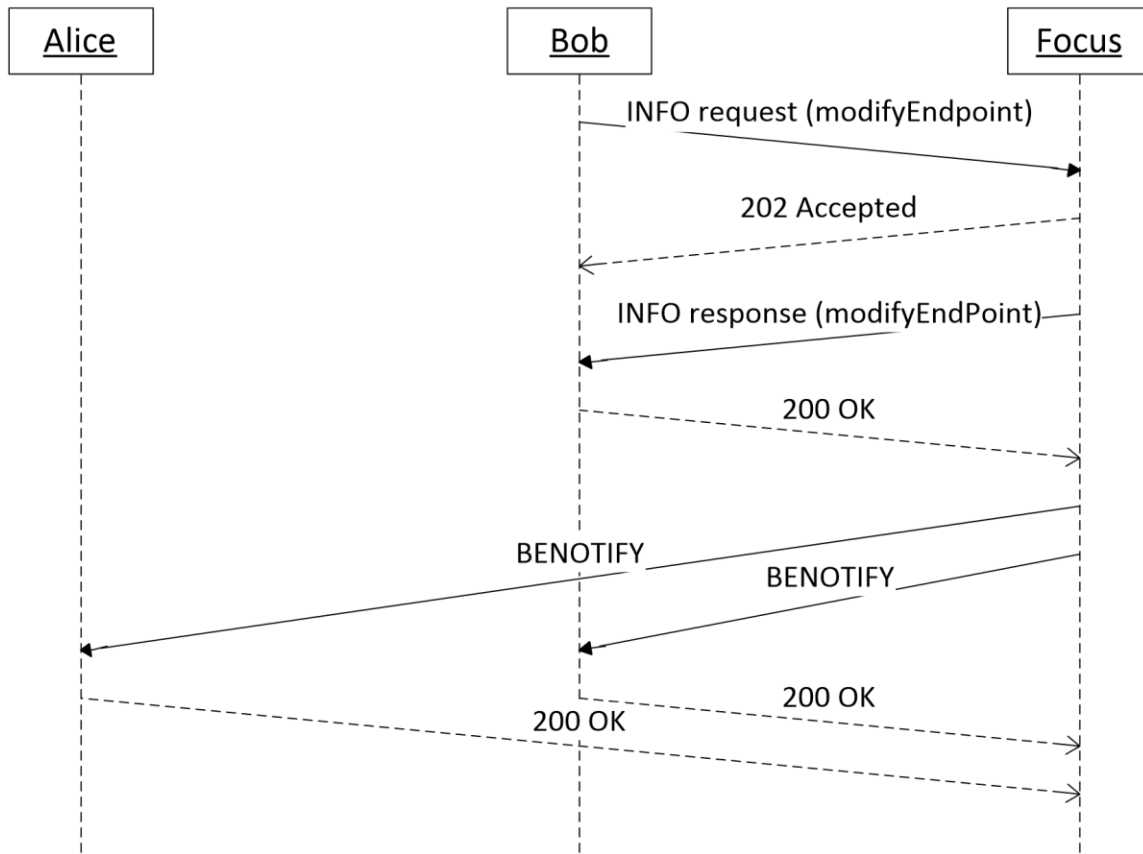

Figure 17: modifyEndpoint call flow

Following is an example of a **modifyEndpoint** request and a corresponding response, to indicate a user's **endpoint** is in recording status.

The client sends a **modifyEndpoint** request to the focus with the **client-recording** element, to notify the focus that Bob's **endpoint** is in recording status.

```

INFO sip:bob@fabrikam.com;gruu;opaque=app:conf:focus:id:97DJ3DYH SIP/2.0
Via: SIP/2.0/TLS 10.1.2.173:10614
Max-Forwards: 70
From: <sip:bob@fabrikam.com>;tag=349cf9e3a2;epid=20d43f4ac2
To: <sip:bob@fabrikam.com;gruu;opaque=app:conf:focus:id:97DJ3DYH>;tag=50230080
Call-ID: 5f73c101f4284d6dadd623cc50e914f3
CSeq: 4 INFO
User-Agent: UCCAPI/4.0.7424.2 OC/4.0.7424.2 (Microsoft Lync 2010)
Supported: ms-dialog-route-set-update
Supported: timer
Proxy-Authorization: TLS-DSK qop="auth", realm="SIP Communications Service",
opaque="1AB56531", targetname="test02.ocs.fabrikam.com", crand="6de69218", cnum="49",
response="8877a5e30c034549ea929572c924fc084dfba274"
Content-Type: application/cccp+xml
Content-Length: 912

<?xml version="1.0"?>
<request xmlns="urn:ietf:params:xml:ns:cccp"
xmlns:mscp="http://schemas.microsoft.com/rtc/2005/08/cccpextensions" C3PVersion="1"

```

```

to="sip:bob@fabrikam.com;gruu;opaque=app:conf:focus:id:97DJ3DYH" from="sip:bob@fabrikam.com"
requestId="298246656">
  <modifyEndpoint>
    <endpointKeys confEntity="sip:bob@fabrikam.com;gruu;opaque=app:conf:focus:id:97DJ3DYH"
userEntity="sip:bob@fabrikam.com" endpointEntity="{F95CF5F8-2A22-4C1F-B65E-2014CF07BD11}"/>
    <ci:endpoint xmlns:ci="urn:ietf:params:xml:ns:conference-info" entity="{F95CF5F8-2A22-
4C1F-B65E-2014CF07BD11}">
      <cis:separator xmlns:cis="urn:ietf:params:xml:ns:conference-info-
separator"></cis:separator>
      <cis:separator xmlns:cis="urn:ietf:params:xml:ns:conference-info-
separator"></cis:separator>
      <msci:client-recording
xmlns:msci="http://schemas.microsoft.com/rtc/2005/08/confinfoextensions"/>
    </ci:endpoint>
  </modifyEndpoint>
</request>

```

The focus validates the request and then responds with a **202 Accepted**, indicating that the command is being processed.

```

SIP/2.0 202 Accepted
Authentication-Info: TLS-DSK qop="auth", opaque="1AB56531", srand="F0F75721", snum="55",
rspauth="f8b2a652b7bf9610f4247ebb38e82c09a65b8f61", targetname="sip/ocs.fabrikam.com",
realm="SIP Communications Service", version=4
From: <sip:bob@fabrikam.com>;tag=349cf9e3a2;epid=20d43f4ac2
To: <sip:bob@fabrikam.com;gruu;opaque=app:conf:focus:id:97DJ3DYH>;tag=50230080
Call-ID: 5f73c101f4284d6dadd623cc50e914f3
CSeq: 4 INFO
Via: SIP/2.0/TLS 10.1.2.173:10614;ms-received-port=10614;ms-received-cid=128FBBF00
Content-Length: 0

```

The focus modifies Bob's endpoint entity and then sends a response, as shown in the following example:

```

INFO sip:10.1.2.173:10614;transport=tls;ms-opaque=4ead93d4a9;ms-received-cid=1773A00;grid
SIP/2.0
Via: SIP/2.0/TLS 10.54.67.185:5061;branch=z9hG4bKA834BA8E.74FC63AE43D39B53;branched=FALSE
Authentication-Info: TLS-DSK qop="auth", opaque="8D1F9B59", srand="470E95DB", snum="57",
rspauth="a27d72a29c83116751c5e2aa5cee890b891a9e3a", targetname="sip/ocs.fabrikam.com",
realm="SIP Communications Service", version=4
Max-Forwards: 70
Content-Length: 233
From: <sip:bob@fabrikam.com;gruu;opaque=app:conf:focus:id:296DSZL0>;tag=D41A0080
To: <sip:bob@fabrikam.com>;tag=f9a01ab5d9;epid=20d43f4ac2
Call-ID: 5a547b0eef2d42f79578d89b426426fc
CSeq: 86 INFO
Supported: ms-dialog-route-set-update
Content-Type: application/cccp+xml
<response xmlns="urn:ietf:params:xml:ns:cccp" requestId="289552528" C3PVersion="1"
from="sip:chuanz@microsoft.com;gruu;opaque=app:conf:focus:id:296DSZL0"
to="sip:chuanz@microsoft.com" code="success">
  <modifyEndpoint/>
</response>

```

The client responds with a **200 OK** response to this INFO request, which is not shown here.

All watchers receive a **notification** from the focus, indicating that Bob's **endpoint** is in recording status:

```

BENOTIFY sip:10.1.2.173:10614;transport=tls;ms-opaque=2c65e5a16c;ms-received-
cid=128FBBF00;grid SIP/2.0
Via: SIP/2.0/TLS 10.54.67.185:5061;branch=z9hG4bK062C1DB6.017FEC5992C515EB;branched=FALSE

```



```
Authentication-Info: TLS-DSK qop="auth", opaque="1AB56531", srand="BEBB7238", snum="60",
rspauth="f45108ca82dcba0f9e5fcfe3e6eef06c51318dba", targetname="sip/ocs.fabrikam.com",
realm="SIP Communications Service", version=4
Max-Forwards: 70
To: <sip:bob@fabrikam.com>;tag=ea00db0f87;epid=20d43f4ac2
Content-Length: 1890
From: <sip:bob@fabrikam.com;gruu;opaque=app:conf:focus:id:97DJ3DYH>;tag=366B0080
Call-ID: afcef931b4094348901ade21738d49dc
CSeq: 5 BENOTIFY
Content-Type: application/conference-info+xml
Event: conference
subscription-state: active;expires=3600
```

```
<conference-info xmlns="urn:ietf:params:xml:ns:conference-info"
xmlns:msci="http://schemas.microsoft.com/rtc/2005/08/confinfoextensions"
xmlns:msim="http://schemas.microsoft.com/rtc/2005/08/imconfinfoextensions"
xmlns:mhci2="http://schemas.microsoft.com/rtc/2008/12/confinfoextensions"
xmlns:cis="urn:ietf:params:xml:ns:conference-info-separator"
entity="sip:bob@fabrikam.com;gruu;opaque=app:conf:focus:id:97DJ3DYH" state="partial"
version="8" static="false">
  <users state="partial">
    <user entity="sip:bob@fabrikam.com" state="full">
      <display-text>Bob</display-text>
      <roles>
        <entry>presenter</entry>
      </roles>
      <endpoint entity="{F95CF5F8-2A22-4C1F-B65E-2014CF07BD11}" msci:session-type="focus"
msci:epid="20d43f4ac2" msci:endpoint-
uri="sip:bob@fabrikam.com;opaque=user:epid:3iWcDF VQlSGstMIXmepcQAA;gruu">
        <!-- snipped -->
        <cis:separator/>
        <cis:separator/>
        <mhci:client-recording/>
      </endpoint>
      <!-- snipped -->
    </user>
  </users>
</conference-info>
```

Another use of a **modifyEndpoint** request and a corresponding response is to send the stop recording message. The request, response and the corresponding notification are the same as they are when sending the start recording message except that the number of instances of the **client-recording** element is zero in the request and notification.

As a completion of recording status notification, the **client-recording** element can be specified in the endpoint element in the INVITE command, to notify the server and other clients that the new user has the recording status enabled. Clients are responsible to handle the policy-related work because the server will not respond failure regardless of whether or not the recording policy is allowed.

When the **in-room-user-notification-supported** property, as defined in [\[MS-CONFPRO\]](#) section 2.2.3.8, is true the **modifyEndpoint** request can also be used to list which users are represented by the same endpoint in the conference by specifying the **endpoint-notification** element and a child **user** element corresponding to each user.

4.4.10 modifyConference

The **modifyConference** command is sent by a client to an MCU to change conference state.

Following is an example **modifyConference** request and the corresponding response.

```
INFO sip:alice@fabrikam;gruu;opaque=app:conf:focus:id:TDVDW046 SIP/2.0
Via: SIP/2.0/TLS ...
Max-Forwards: 70
```

From: <sip:alice@fabrikam.com>;tag=7a5dbfcb7d;epid=5c1bcd7656
To: <sip:alice@fabrikam.com;gruu;opaque=app:conf:focus:id:TDVDW046>;tag=145E0080
Call-ID: a521cfd600db43d48e2747bd75e7bbae
CSeq: 3 INFO
Route: ...
User-Agent: UCCAPI/4.0.7468.0 OC/4.0.7468.0 (Microsoft Lync 2010)
Supported: ms-dialog-route-set-update
Supported: timer
Proxy-Authorization: ...
Content-Type: application/cv+xml
Content-Length: 1466

```
<?xml version="1.0"?>
<request xmlns="urn:ietf:params:xml:ns:cvc"
  xmlns:mvc="http://schemas.microsoft.com/rtc/2005/08/cvcextensions"
  C3PVersion="1"
  to="sip:alice@fabrikam.com;gruu;opaque=app:conf:focus:id:TDVDW046"
  from="sip:alice@fabrikam.com"
  requestId="355465752">
  <modifyConference mvc:mcuUri="sip:alice@fabrikam.com;gruu;opaque=app:conf:audio-
video:id:TDVDW046">
    <conference-info xmlns="urn:ietf:params:xml:ns:conference-info"
      entity="sip:alice@fabrikam.com;gruu;opaque=app:conf:focus:id:TDVDW046"
      state="partial">
      <mvc:conference-view
xmlns:mvc="http://schemas.microsoft.com/rtc/2005/08/confinfoextensions"
        ci:state="partial"
        xmlns:ci="urn:ietf:params:xml:ns:conference-info">
      <mvc:entity-view ci:state="partial"
        entity="sip:alice@fabrikam.com;gruu;opaque=app:conf:audio-video:id:TDVDW046">
      <mvc:entity-state>
        <mvc:mediaFiltersRules>
          <mvc:mayModifyOwnFilters>
            <mvc:role>presenter</mvc:role>
            <mvc:value>true</mvc:value>
          </mvc:mayModifyOwnFilters>
          <mvc:mayModifyOwnFilters>
            <mvc:role>default</mvc:role>
            <mvc:value>>false</mvc:value>
          </mvc:mayModifyOwnFilters>
          <mvc:initialFilters>
            <mvc:role>presenter</mvc:role>
            <mvc:ingressFilter>block</mvc:ingressFilter>
          </mvc:initialFilters>
          <mvc:initialFilters>
            <mvc:role>default</mvc:role>
            <mvc:ingressFilter>block</mvc:ingressFilter>
          </mvc:initialFilters>
        </mvc:mediaFiltersRules>
      </mvc:entity-state>
    </mvc:entity-view>
  </mvc:conference-view>
</conference-info>
</modifyConference>
</request>
```

SIP/2.0 202 Accepted
Authentication-Info: ...
From: <sip:alice@fabrikam.com>;tag=7a5dbfcb7d;epid=5c1bcd7656
To: <sip:alice@fabrikam.com;gruu;opaque=app:conf:focus:id:TDVDW046>;tag=145E0080
Call-ID: a521cfd600db43d48e2747bd75e7bbae
CSeq: 3 INFO
Via: ...
Content-Length: 0
INFO sip:10.121.251.124:57818;transport=tls;ms-opaque=fa63f33d72;ms-received-
cid=290F0100;grid SIP/2.0
Via: ...
Authentication-Info: ...
Max-Forwards: 70

Content-Length: 551
From: <sip:alice@fabrikam.com;gruu;opaque=app:conf:focus:id:TDVDW046>;tag=145E0080
To: <sip:alice@fabrikam.com>;tag=7a5dbfcb7d;epid=5c1bcd7656
Call-ID: a521cfd600db43d48e2747bd75e7bbae
CSeq: 1396 INFO
Supported: ms-dialog-route-set-update
Content-Type: application/cccp+xml

```
<response xmlns="urn:ietf:params:xml:ns:cccp"
  xmlns:ci="urn:ietf:params:xml:ns:conference-info"
  requestId="355465752"
  C3PVersion="1"
  from="sip:alice@fabrikam.com;gruu;opaque=app:conf:focus:id:TDVDW046"
  to="sip:alice@fabrikam.com"
  responder="sip:alice@fabrikam.com;gruu;opaque=app:conf:audio-video:id:TDVDW046"
  code="success">
  <modifyConference>
    <conference-info xmlns="urn:ietf:params:xml:ns:conference-info"
      entity="sip:alice@fabrikam.com;gruu;opaque=app:conf:focus:id:TDVDW046"
      state="partial"/>
  </modifyConference>
</response>
```

SIP/2.0 200 OK
Via: ...
From: <sip:alice@fabrikam.com;gruu;opaque=app:conf:focus:id:TDVDW046>;tag=145E0080
To: <sip:alice@fabrikam.com>;tag=7a5dbfcb7d;epid=5c1bcd7656
Call-ID: a521cfd600db43d48e2747bd75e7bbae
CSeq: 1396 INFO
Contact: <sip:alice@fabrikam.com;opaque=user:epid:v19MMU0DdFWrARgZPvwZuQAA;gruu>
User-Agent: UCCAPI/4.0.7468.0 OC/4.0.7468.0 (Microsoft Lync 2010)
Proxy-Authorization: ...
Content-Length: 0

Prelim

5 Security

5.1 Security Considerations for Implementers

None.

5.2 Index of Security Parameters

None.

Preliminary

6 Appendix A: Full XML Schema

6.1 application/vnd.microsoft.ocsmeeeting Schema

6.1.1 simplejoinconfdoc Namespace

This namespace is identified by the following URN:

<http://schemas.microsoft.com/rtc/2009/05/simplejoinconfdoc>

This schema depends on several extension schema-sets, which are defined subsequently.

```
<?xml version="1.0" encoding="utf-8"?>
<xs:schema
  targetNamespace="http://schemas.microsoft.com/rtc/2009/05/simplejoinconfdoc"
  version="1.0"
  attributeFormDefault="unqualified" elementFormDefault="qualified"
  xmlns:xs="http://www.w3.org/2001/XMLSchema"
  xmlns:tns="http://schemas.microsoft.com/rtc/2009/05/simplejoinconfdoc"
  xmlns:sjcdext="http://schemas.microsoft.com/rtc/2016/09/simplejoinconfdoc-extensions"
  xmlns:sjcds="http://schemas.microsoft.com/rtc/2016/09/simplejoinconfdoc-separator">
  <!--
    This import brings in the Confdoc separator
  -->
  <xs:import namespace="http://schemas.microsoft.com/rtc/2016/09/simplejoinconfdoc-
separator" schemaLocation="confdoc-separator.xsd"></xs:import>

  <!--
    This import brings in the Confdoc extensions
  -->
  <xs:import namespace="http://schemas.microsoft.com/rtc/2016/09/simplejoinconfdoc-
extensions" schemaLocation="confdoc-ext.xsd"></xs:import>
  <xs:complexType name="conf-info-type">
    <xs:sequence>
      <!-- conference uri -->
      <xs:element name="conf-uri" type="xs:string" />

      <!-- time (in milli-seconds) taken by the server to process the request -->
      <xs:element name="server-time" type="xs:string" />

      <!-- original url coming in to the server -->
      <xs:element name="original-incoming-url" type="xs:string" />

      <!-- conference key -->
      <xs:element name="conf-key" type="xs:string" />
      <xs:element name="fallback-url" type="xs:string" />
      <xs:element name="ucwa-url" type="xs:string" />
      <xs:element name="ucwa-ext-url" type="xs:string" />
      <xs:element name="ucwa-int-url" type="xs:string" />
      <xs:element name="telemetry-id" type="xs:string" />
      <xs:sequence minOccurs="0">
        <xs:element ref="sjcds:separator" />
        <xs:element ref="sjcdext:pstn-access" minOccurs="0" />
        <xs:element ref="sjcdext:ucwa-discovery-url" minOccurs="0" />
        <xs:sequence minOccurs="0">
          <xs:element ref="sjcds:separator" />
          <xs:element ref="sjcdext:ucwa-public-url" minOccurs="0" />
          <xs:element ref="sjcdext:tenant-id" minOccurs="0" />
        <xs:sequence minOccurs="0">
          <xs:element ref="sjcds:separator" />
          <xs:any namespace="##other" processContents="lax"
maxOccurs="unbounded" />
        </xs:sequence>
      </xs:sequence>
    </xs:sequence>
  </xs:complexType>
</xs:schema>
```

```

    </xs:sequence>
    <xs:anyAttribute namespace="##other" processContents="lax"/>
  </xs:complexType>
  <xs:element name="conf-info" type="tns:conf-info-type" />
</xs:schema>

```

6.1.2 simplejoinconfdoc-extensions Namespace

This namespace is identified by the following URN:

<http://schemas.microsoft.com/rtc/2016/09/simplejoinconfdoc-extensions>

```

<?xml version="1.0" encoding="utf-8"?>
<xs:schema
  targetNamespace="http://schemas.microsoft.com/rtc/2016/09/simplejoinconfdoc-extensions"
  version="1.0"
  attributeFormDefault="unqualified" elementFormDefault="qualified"
  xmlns:xs="http://www.w3.org/2001/XMLSchema"
  xmlns:tns="http://schemas.microsoft.com/rtc/2016/09/simplejoinconfdoc-extensions"
  xmlns:sjcds="http://schemas.microsoft.com/rtc/2016/09/simplejoinconfdoc-separator">

  <!--
    This import brings in the Confdoc separator
  -->
  <xs:import namespace="http://schemas.microsoft.com/rtc/2016/09/simplejoinconfdoc-
separator" schemaLocation="confdoc-separator.xsd"></xs:import>

  <xs:complexType name="pstn-access-type">
    <xs:sequence>
      <xs:element name="meeting-id" type="tns:pstn-meeting-id-type" minOccurs="0" />
      <xs:element name="default-access-numbers" type="tns:pstn-access-numbers-type"
minOccurs="0" />
      <xs:element name="access-numbers" type="tns:pstn-access-numbers-type"
minOccurs="0" />
      <xs:element name="dialing-formats" type="tns:dialing-formats-type" minOccurs="0"
/>
      <xs:sequence minOccurs="0">
        <xs:element ref="sjcds:separator" />
        <xs:any namespace="##other" processContents="lax" minOccurs="0"
maxOccurs="unbounded"/>
      </xs:sequence>
    </xs:sequence>
    <xs:anyAttribute namespace="##other" processContents="lax"/>
  </xs:complexType>

  <xs:simpleType name="pstn-meeting-id-type">
    <xs:restriction base="xs:string">
      <xs:pattern value="[1-9][0-9]*"/>
    </xs:restriction>
  </xs:simpleType>

  <xs:complexType name="pstn-access-numbers-type">
    <xs:sequence>
      <xs:element name="access-number" type="tns:pstn-access-number-type" minOccurs="0"
maxOccurs="unbounded" />
      <xs:sequence minOccurs="0">
        <xs:element ref="sjcds:separator" />
        <xs:any namespace="##other" processContents="lax" minOccurs="0"
maxOccurs="unbounded"/>
      </xs:sequence>
    </xs:sequence>
    <xs:anyAttribute namespace="##other" processContents="lax"/>
  </xs:complexType>

  <xs:complexType name="pstn-access-number-type">
    <xs:sequence>

```

```

    <xs:element name="city" type="xs:string" />
    <xs:element name="country" type="xs:string" />
    <xs:element name="number" type="xs:string" />
    <xs:element name="toll-free" type="xs:boolean" />
    <xs:sequence minOccurs="0">
      <xs:element ref="sjcds:separator" />
      <xs:any namespace="##other" processContents="lax" minOccurs="0"
maxOccurs="unbounded"/>
    </xs:sequence>
  </xs:sequence>
  <xs:anyAttribute namespace="##other" processContents="lax"/>
</xs:complexType>

<xs:complexType name="dialing-formats-type" >
  <xs:sequence>
    <xs:element name="dialing-format" type="xs:string" />
    <xs:element name="dialing-format-organizer" type="xs:string" />
    <xs:sequence minOccurs="0">
      <xs:element ref="sjcds:separator" />
      <xs:any namespace="##other" processContents="lax" minOccurs="0"
maxOccurs="unbounded"/>
    </xs:sequence>
  </xs:sequence>
  <xs:anyAttribute namespace="##other" processContents="lax"/>
</xs:complexType>

<xs:element name="pstn-access" type="tns:pstn-access-type" />
<xs:element name="ucwa-discovery-url" type="xs:string" />
<xs:element name="ucwa-public-url" type="xs:string" />
<xs:element name="tenant-id" type="xs:string" />

</xs:schema>

```

6.1.3 simplejoinconfdoc-separator Namespace

This namespace is identified by the following URN:

<http://schemas.microsoft.com/rtc/2016/09/simplejoinconfdoc-separator>

```

<?xml version="1.0" encoding="utf-8"?>
<xs:schema
  targetNamespace="http://schemas.microsoft.com/rtc/2016/09/simplejoinconfdoc-separator"
  version="1.0"
  attributeFormDefault="unqualified" elementFormDefault="qualified"
  xmlns:xs="http://www.w3.org/2001/XMLSchema"
  xmlns:tns="http://schemas.microsoft.com/rtc/2016/09/simplejoinconfdoc-separator">
  <!--
  This defines a separator marking the beginning of extensions
  -->
  <xs:element name="separator">
    <xs:complexType />
  </xs:element>
</xs:schema>

```

6.2 application/cccp+xml Schema

6.2.1 cccp Namespace

This namespace is identified by the following URN:

urn:ietf:params:xml:ns:cccp

This schema depends on several extension schema-sets, which are defined subsequently.

```
<?xml version="1.0" encoding="utf-8"?>
<xs:schema
  targetNamespace="urn:ietf:params:xml:ns:cccp"
  xmlns:tns="urn:ietf:params:xml:ns:cccp"
  xmlns:xs="http://www.w3.org/2001/XMLSchema"
  xmlns:ci="urn:ietf:params:xml:ns:conference-info"
  xmlns:cis="urn:ietf:params:xml:ns:conference-info-separator"
  xmlns:mhci="http://schemas.microsoft.com/rtc/2005/08/confinfoextensions"
  xmlns:mhcp="http://schemas.microsoft.com/rtc/2005/08/cccpextensions"
  xmlns:mhsls="urn:ietf:params:xml:ns:mhsls"
  xmlns:ms="urn:microsoft-cpp-xml-serializer"
  elementFormDefault="qualified"
  attributeFormDefault="unqualified">

  <!--
    This import brings in the standard Conference Package definitions
  -->
  <xs:import namespace="urn:ietf:params:xml:ns:conference-info" schemaLocation="ms-
ci.xsd" />
  <!--
    This import brings in the standard Conference Package Standard Separator
    definitions
  -->
  <xs:import namespace="urn:ietf:params:xml:ns:conference-info-separator"
schemaLocation="ms-ci-separator.xsd" />
  <!--
    This import brings in the Conference Package MS extensions
  -->
  <xs:import namespace="http://schemas.microsoft.com/rtc/2005/08/confinfoextensions"
schemaLocation="ms-ci-ext.xsd" />
  <!--
    This import brings in the CCCP MS extensions
  -->
  <xs:import namespace="http://schemas.microsoft.com/rtc/2005/08/cccpextensions"
schemaLocation="ms-cccp-ext.xsd" />
  <!--
    This import brings in the CCCP MS conference key hash extensions
  -->
  <xs:import namespace="urn:ietf:params:xml:ns:mhsls" schemaLocation="ms-ls.xsd"
ms:notPublished="true" />

  <!-- NOTIFY ELEMENT -->
  <xs:element name="notify" type="tns:notify-type"/>

  <!-- REQUEST ELEMENT -->
  <xs:element name="request" type="tns:request-type"/>

  <!-- RESPONSE ELEMENT -->
  <xs:element name="response" type="tns:response-type"/>

  <!-- AGGREGATED RESPONSE ELEMENT -->
  <xs:element name="aggregatedResponse" type="tns:aggregated-response-type"/>

  <!-- NOTIFY TYPE -->
  <xs:complexType name="notify-type">
    <xs:choice>
      <xs:sequence>
        <xs:element ref="ci:conference-info"/>
        <xs:any namespace="##other" processContents="lax" minOccurs="0"
maxOccurs="unbounded" />
      </xs:sequence>
      <xs:sequence>
        <xs:element name="mcus-info" type="tns:server-list-type" />
        <xs:any namespace="##other" processContents="lax" minOccurs="0"
maxOccurs="unbounded" />
      </xs:sequence>
    </xs:choice>
  </xs:complexType>

```



```

<xs:attribute name="notificationId" type="xs:string" use="required"/>
<!-- The CCCP version of the notification -->
<xs:attribute name="C3PVersion" type="xs:string" use="optional"/>
<!-- The URI of the CCCP server sending the CCCP notification -->
<xs:attribute name="from" type="xs:anyURI" use="required"/>
<!-- The URI of the CCCP client the CCCP notification is destined to -->
<xs:attribute name="to" type="xs:anyURI" use="required"/>
<!-- The trusted Identifier of the originator of the notification -->
<xs:attribute name="originator" type="xs:anyURI" use="optional" />
<!-- True if this notification was proxied -->
<xs:attribute ref="msci:is-proxied" use="optional"/>
<xs:anyAttribute namespace="##other" processContents="lax" />
</xs:complexType>

<!-- REQUEST TYPE -->
<xs:complexType name="request-type">
  <xs:sequence maxOccurs="unbounded">
    <xs:choice>
      <xs:element name="addConference" type="tns:add-conference-type" />
      <xs:element name="addEndpointMedia" type="tns:add-endpoint-media-type" />
      <xs:element name="addSidebar" type="tns:add-sidebar-type" />
      <xs:element name="addUser" type="tns:add-user-type" />
      <xs:element name="endorseUser" type="tns:endorse-user-type" />

      <xs:element name="deleteConference" type="tns:delete-conference-type" />
      <xs:element name="deleteConferences" type="tns:delete-conferences-type" />
      <xs:element name="deleteEndpointMedia" type="tns:delete-endpoint-media-type" />
      <xs:element name="deleteSidebar" type="tns:delete-sidebar-type" />
      <xs:element name="deleteUser" type="tns:delete-user-type" />

      <xs:element name="getAvailableMcuTypes" type="tns:get-available-mcu-types-type"/>
      <xs:element name="getConference" type="tns:get-conference-type"/>
      <xs:element name="getConferences" type="tns:get-conferences-type"/>
      <xs:element name="getEncryptionKey" type="tns:get-encryption-key-type"/>
      <xs:element name="getMcu" type="tns:get-mcu-type"/>
      <xs:element name="getMeetingId" type="tns:get-meeting-id-type"/>

      <xs:element name="verifyConferenceKey" type="tns:verify-confkey-type" />

      <xs:element name="modifyConference" type="tns:add-conference-type" />
      <xs:element name="modifyConferenceLock" type="tns:modify-conference-lock-type" />
      <xs:element name="modifyConferenceAnnouncements" type="tns:modify-conference-
announcements-type" />
      <xs:element name="modifyEndpoint" type="tns:modify-endpoint-type" />
      <xs:element name="modifyEndpointMedia" type="tns:add-endpoint-media-type" />
      <xs:element name="modifyEndpointRole" type="tns:modify-endpoint-role-type" />
      <xs:element name="modifySidebar" type="tns:add-sidebar-type" />
      <xs:element name="modifyUser" type="tns:add-user-type" />
      <xs:element name="modifyUsersMediaFilters" type="tns:modify-users-media-filters-
type" />
      <xs:element name="modifyUserRoles" type="tns:modify-user-roles-type" />

      <xs:element name="moveUserToSidebar" type="tns:move-user-to-sidebar-type" />

      <xs:element name="ping" type="tns:ping-type" />

      <xs:element name="playRecordedName" type="tns:play-recorded-name-type" />

      <xs:element name="setUserAccess" type="tns:set-user-access-type" />
      <xs:element name="setLobbyAccess" type="tns:set-lobby-access-type" />

      <xs:element name="startRecording" type="tns:start-recording-type" />
      <xs:element name="stopRecording" type="tns:stop-recording-type" />
      <xs:element name="pauseRecording" type="tns:pause-recording-type" />
      <xs:element name="resumeRecording" type="tns:resume-recording-type" />

      <xs:element name="getConferenceKeyHash" type="tns:get-conference-key-hash-type"
ms:notPublished="true"/>
    
  

```

```

    <xs:element name="getConferencingCapabilities" type="tns:get-conferencing-
capabilities-type"/>

    <xs:element name="resolveConference" type="tns:resolve-conference-type"/>

    <xs:element name="queryMeetingId" type="tns:query-meeting-id-type"/>
    <xs:element name="deleteMeetingId" type="tns:delete-meeting-id-type"/>

    <xs:any namespace="##other" processContents="lax" minOccurs="0"
maxOccurs="unbounded" />
  </xs:choice>
</xs:sequence>
<xs:attribute name="requestId" type="xs:string" use="required"/>
<!-- The CCCP version of the originator of the request -->
<xs:attribute name="C3PVersion" type="xs:string" use="optional"/>
<!-- The URI of the CCCP client sending the CCCP request -->
<xs:attribute name="from" type="xs:anyURI" use="required"/>
<!-- The URI of the CCCP server the request is destined to -->
<xs:attribute name="to" type="xs:anyURI" use="required"/>
<!-- The URI of the final CCCP target server the request is destined to -->
<xs:attribute name="target" type="xs:anyURI" use="optional"/>
<!-- The trusted Identifier of the originator of the request -->
<xs:attribute name="originator" type="xs:anyURI" use="optional"/>
<xs:anyAttribute namespace="##other" processContents="lax" />
</xs:complexType>

<!-- RESPONSE TYPE -->
<xs:complexType name="response-type">
  <xs:sequence minOccurs="0" maxOccurs="unbounded">
    <xs:choice>
      <xs:element name="addConference" type="tns:add-conference-response-type" />
      <xs:element name="addEndpointMedia" type="tns:add-endpoint-media-response-type"
/>

      <xs:element name="addSidebar" type="tns:add-sidebar-response-type" />
      <xs:element name="addUser" type="tns:add-user-response-type" />
      <xs:element name="endorseUser" type="tns:endorse-user-response-type" />

      <xs:element name="deleteConference" type="tns:delete-conference-response-type" />
      <xs:element name="deleteConferences" type="tns:delete-conferences-response-type"
/>

      <xs:element name="deleteEndpointMedia" type="tns:delete-endpoint-media-response-
type" />
      <xs:element name="deleteSidebar" type="tns:delete-sidebar-response-type" />
      <xs:element name="deleteUser" type="tns:delete-user-response-type" />

      <xs:element name="verifyConferenceKey" type="tns:verify-confkey-response-type" />

      <xs:element name="getAvailableMcuTypes" type="tns:get-available-mcu-types-
response-type"/>
      <xs:element name="getConference" type="tns:get-conference-response-type"/>
      <xs:element name="getConferences" type="tns:get-conferences-response-type"/>
      <xs:element name="getEncryptionKey" type="tns:get-encryption-key-response-type"/>
      <xs:element name="getMcu" type="tns:get-mcu-response-type"/>
      <xs:element name="getMeetingId" type="tns:get-meeting-id-response-type"/>

      <xs:element name="modifyConference" type="tns:add-conference-response-type" />
      <xs:element name="modifyConferenceLock" type="tns:modify-conference-lock-
response-type" />
      <xs:element name="modifyConferenceAnnouncements" type="tns:modify-conference-
announcements-response-type" />
      <xs:element name="modifyEndpoint" type="tns:modify-endpoint-response-type" />
      <xs:element name="modifyEndpointMedia" type="tns:add-endpoint-media-response-
type" />
      <xs:element name="modifyEndpointRole" type="tns:modify-endpoint-role-response-
type" />
      <xs:element name="modifySidebar" type="tns:add-sidebar-response-type" />
      <xs:element name="modifyUser" type="tns:add-user-response-type" />
      <xs:element name="modifyUsersMediaFilters" type="tns:modify-users-media-filters-
response-type" />

```

```

        <xs:element name="modifyUserRoles" type="tns:modify-user-roles-response-type" />
        <xs:element name="moveUserToSidebar" type="tns:move-user-to-sidebar-response-
type" />
        <xs:element name="ping" type="tns:ping-response-type"/>
        <xs:element name="playRecordedName" type="tns:play-recorded-name-response-type"
/>
        <xs:element name="setUserAccess" type="tns:set-user-access-response-type" />
        <xs:element name="setLobbyAccess" type="tns:set-lobby-access-response-type" />
        <xs:element name="startRecording" type="tns:start-recording-response-type" />
        <xs:element name="stopRecording" type="tns:stop-recording-response-type" />
        <xs:element name="pauseRecording" type="tns:pause-recording-response-type" />
        <xs:element name="resumeRecording" type="tns:resume-recording-response-type" />
        <xs:element name="getConferenceKeyHash" type="tns:get-conference-key-hash-
response-type" ms:notPublished="true"/>
        <xs:element name="getConferencingCapabilities" type="tns:get-conferencing-
capabilities-response-type"/>
        <xs:element name="resolveConference" type="tns:resolve-conference-response-
type"/>
        <xs:element name="queryMeetingId" type="tns:query-meeting-id-response-type"/>
        <xs:element name="deleteMeetingId" type="tns:delete-meeting-id-response-type"/>
        <xs:any namespace="##other" processContents="lax" minOccurs="0"
maxOccurs="unbounded" />
    </xs:choice>
</xs:sequence>
<xs:attribute name="requestId" type="xs:string" use="required"/>
<!--
    The CCCP version of the originator of the recipient of the request
-->
<xs:attribute name="C3PVersion" type="xs:string" use="optional"/>
<!--
    The URI of the CCCP server sending the CCCP response
-->
<xs:attribute name="from" type="xs:anyURI" use="required"/>
<!--
    The URI of the CCCP client the response is destined to
-->
<xs:attribute name="to" type="xs:anyURI" use="required"/>
<!--
    The trusted Identifier of the responder
-->
<xs:attribute name="responder" type="xs:anyURI" use="optional"/>
<xs:attribute name="code" type="tns:response-code-type" use="required"/>
<xs:attribute name="reason" type="tns:reason-code-type-ex" use="optional"/>
<xs:attribute name="displayString" type="xs:string" use="optional"/>
<xs:attribute name="timeOut" type="xs:nonNegativeInteger" use="optional"/>
<xs:attribute name="retryAfter" type="xs:nonNegativeInteger" use="optional"/>
<xs:attribute name="version" type="xs:nonNegativeInteger" use="optional"/>
<xs:anyAttribute namespace="##other" processContents="lax" />
</xs:complexType>
<!-- AGGREGATED RESPONSE TYPE -->
<xs:complexType name="aggregated-response-type">
    <xs:sequence>
        <xs:element name="response" type="tns:response-type" minOccurs="0"
maxOccurs="unbounded"/>
        <xs:any namespace="##other" processContents="lax" minOccurs="0"
maxOccurs="unbounded" />
    </xs:sequence>

```

```

<xs:attribute ref="ci:state" use="optional" default="full"/>
<xs:attribute name="requestId" type="xs:string" use="required"/>
<xs:attribute name="from" type="xs:anyURI" use="required"/>
<xs:attribute name="to" type="xs:anyURI" use="required"/>
<xs:attribute name="responder" type="xs:anyURI" use="optional"/>
<xs:attribute name="code" type="tns:response-code-type" use="required"/>
<xs:attribute name="reason" type="tns:reason-code-type-ex" use="optional"/>
<xs:attribute name="displayString" type="xs:string" use="optional"/>
<xs:attribute name="timeOut" type="xs:nonNegativeInteger" use="optional"/>
<xs:attribute name="retryAfter" type="xs:nonNegativeInteger" use="optional"/>
<xs:anyAttribute namespace="##other" processContents="lax"/>
</xs:complexType>

<!-- RESPONSE CODE TYPE -->
<xs:simpleType name="response-code-type">
  <xs:restriction base="xs:string">
    <xs:enumeration value="success" />
    <xs:enumeration value="pending" />
    <xs:enumeration value="failure" />
  </xs:restriction>
</xs:simpleType>

<!-- REASON CODE TYPE -->
<xs:simpleType name="reason-code-type-ex">
  <xs:union memberTypes="tns:reason-code-type xs:string"/>
</xs:simpleType>

<xs:simpleType name="reason-code-type">
  <xs:restriction base="xs:string">
    <xs:enumeration value="serverBusy" />
    <xs:enumeration value="timeout" />
    <xs:enumeration value="unauthorized" />
    <xs:enumeration value="requestMalformed" />
    <xs:enumeration value="requestTooLarge" />
    <xs:enumeration value="requestCancelled" />
    <xs:enumeration value="notSupported" />
    <xs:enumeration value="otherFailure" />
  </xs:restriction>
</xs:simpleType>

<!-- CONFERENCE KEYS TYPE -->
<xs:complexType name="conference-keys-type">
  <xs:attribute name="confEntity" type="xs:anyURI"/>
  <xs:attribute ref="msci:conference-id"/>
  <xs:attribute ref="mscp:telemetry-id" use="optional"/>
  <xs:anyAttribute namespace="##other" processContents="lax" />
</xs:complexType>

<!-- SIDEBAR KEYS TYPE -->
<xs:complexType name="sidebar-keys-type">
  <xs:attribute name="confEntity" type="xs:anyURI" />
  <xs:attribute name="sidebarEntity" type="xs:anyURI" />
  <xs:anyAttribute namespace="##other" processContents="lax" />
</xs:complexType>

<!-- RECORDING KEYS TYPE -->

```

```

<xs:complexType name="recording-keys-type">
  <xs:attribute name="confEntity" type="xs:anyURI" use="required" />
  <xs:attribute name="recordingId" type="xs:string" use="required" />
  <xs:anyAttribute namespace="##other" processContents="lax" />
</xs:complexType>

<!-- USER KEYS TYPE -->
<xs:complexType name="user-keys-type">
  <xs:attribute name="confEntity" type="xs:anyURI"/>
  <xs:attribute name="userEntity" type="xs:anyURI"/>
  <xs:anyAttribute namespace="##other" processContents="lax" />
</xs:complexType>

<!-- ENDPOINT KEYS TYPE -->
<xs:complexType name="endpoint-keys-type">
  <xs:attribute name="confEntity" type="xs:anyURI"/>
  <xs:attribute name="userEntity" type="xs:anyURI"/>
  <xs:attribute name="endpointEntity" type="xs:string"/>
  <xs:anyAttribute namespace="##other" processContents="lax" />
</xs:complexType>

<!-- MEDIA KEYS TYPE -->
<xs:complexType name="media-keys-type">
  <xs:attribute name="confEntity" type="xs:anyURI"/>
  <xs:attribute name="userEntity" type="xs:anyURI"/>
  <xs:attribute name="endpointEntity" type="xs:string"/>
  <xs:attribute name="mediaId" type="xs:string" />
  <xs:anyAttribute namespace="##other" processContents="lax" />
</xs:complexType>

<!-- PING TYPE -->
<xs:complexType name="ping-type">
  <xs:sequence>
    <xs:element name="conferenceKeys" type="tns:conference-keys-type" minOccurs="0" />
    <xs:element name="startupTime" type="xs:dateTime"/>
    <xs:any namespace="##other" processContents="lax" minOccurs="0"
maxOccurs="unbounded" />
  </xs:sequence>
  <xs:anyAttribute namespace="##other" processContents="lax" />
</xs:complexType>

<!-- PING RESPONSE TYPE -->
<xs:complexType name="ping-response-type">
  <xs:sequence>
    <xs:element ref="mscp:diagnostics-info" minOccurs="0"/>
    <xs:element name="startupTime" type="xs:dateTime" minOccurs="0" />
    <xs:element name="serverStatus" type="tns:server-status-type" minOccurs="0"/>
    <xs:sequence minOccurs="0">
      <xs:element ref="cis:separator" />
      <xs:any namespace="##other" processContents="lax" maxOccurs="unbounded" />
    </xs:sequence>
  </xs:sequence>
  <xs:attribute name="reason" type="tns:ping-reason-code-type-ex" use="optional"/>
  <xs:anyAttribute namespace="##other" processContents="lax"/>
</xs:complexType>

<!-- PING REASON CODE TYPE -->
<xs:simpleType name="ping-reason-code-type-ex">
  <xs:union memberTypes="tns:ping-reason-code-type xs:string"/>
</xs:simpleType>

<xs:simpleType name="ping-reason-code-type">
  <xs:restriction base="xs:string">
    <xs:enumeration value="conferenceDoesntExist"/>
    <xs:enumeration value="otherFailure"/>
  </xs:restriction>
</xs:simpleType>

<!-- GET MCU TYPE -->

```

```

<xs:complexType name="get-mcu-type">
  <xs:sequence>
    <xs:element ref="ci:conference-info" minOccurs="0"/>
    <xs:element name="mcu-descriptor-list" type="tns:server-list-type" minOccurs="0" />
    <xs:sequence minOccurs="0">
      <xs:element ref="cis:separator" />
      <xs:any namespace="##other" processContents="lax" maxOccurs="unbounded" />
    </xs:sequence>
  </xs:sequence>
  <xs:anyAttribute namespace="##other" processContents="lax"/>
</xs:complexType>

<!-- GET MCU RESPONSE TYPE -->
<xs:complexType name="get-mcu-response-type">
  <xs:sequence>
    <xs:element ref="mscp:diagnostics-info" minOccurs="0"/>
    <xs:element name="mcu-list" type="tns:server-list-type" minOccurs="0"/>
    <xs:sequence minOccurs="0">
      <xs:element ref="cis:separator" />
      <xs:any namespace="##other" processContents="lax" maxOccurs="unbounded" />
    </xs:sequence>
  </xs:sequence>
  <xs:attribute name="reason" type="tns:get-mcu-reason-code-type-ex" use="optional"/>
  <xs:anyAttribute namespace="##other" processContents="lax" />
</xs:complexType>

<!-- GET MCU REASON CODE TYPE -->
<xs:simpleType name="get-mcu-reason-code-type-ex">
  <xs:union memberTypes="tns:get-mcu-reason-code-type xs:string"/>
</xs:simpleType>

<xs:simpleType name="get-mcu-reason-code-type">
  <xs:restriction base="xs:string">
    <xs:enumeration value="unknownMcuType"/>
    <xs:enumeration value="otherFailure"/>
  </xs:restriction>
</xs:simpleType>

<!-- ADD CONFERENCE TYPE -->
<xs:complexType name="add-conference-type">
  <xs:sequence>
    <xs:element ref="ci:conference-info"/>
    <xs:any namespace="##other" processContents="lax" minOccurs="0"
maxOccurs="unbounded" />
  </xs:sequence>
  <xs:attribute ref="mscp:mcuUri" use="optional"/>
  <xs:attribute ref="mscp:conferenceInstance" use="optional" />
  <xs:anyAttribute namespace="##other" processContents="lax" />
</xs:complexType>

<!-- ADD CONFERENCE RESPONSE TYPE -->
<xs:complexType name="add-conference-response-type">
  <xs:sequence>
    <xs:element ref="mscp:diagnostics-info" minOccurs="0"/>
    <xs:element ref="ci:conference-info" minOccurs="0"/>
    <xs:element name="notification" type="xs:boolean" minOccurs="0"/>
    <xs:sequence minOccurs="0">
      <xs:element ref="cis:separator" />
      <xs:any namespace="##other" processContents="lax" maxOccurs="unbounded" />
    </xs:sequence>
  </xs:sequence>
  <xs:attribute ref="mscp:mcuUri" use="optional"/>
  <xs:attribute name="reason" type="tns:add-conference-reason-code-type-ex"
use="optional"/>
  <xs:anyAttribute namespace="##other" processContents="lax" />
</xs:complexType>

<!-- ADD CONFERENCE REASON CODE TYPE -->
<xs:simpleType name="add-conference-reason-code-type-ex">

```

```

    <xs:union memberTypes="tns:add-conference-reason-code-type xs:string"/>
</xs:simpleType>

<xs:simpleType name="add-conference-reason-code-type">
  <xs:restriction base="xs:string">
    <xs:enumeration value="anonymousUsersNotAllowed" />
    <xs:enumeration value="conferenceExistsAlready" />
    <xs:enumeration value="entitySettingsTooLarge" />
    <xs:enumeration value="federatedUsersNotAllowed" />
    <xs:enumeration value="forbidden" />
    <xs:enumeration value="invalidAdmissionPolicy" />
    <xs:enumeration value="invalidEncryptionKeyUsed" />
    <xs:enumeration value="invalidConferenceId" />
    <xs:enumeration value="invalidExpiryTime" />
    <xs:enumeration value="invalidPasscode" />
    <xs:enumeration value="invalidRole" />
    <xs:enumeration value="invalidUserEntity" />
    <xs:enumeration value="maxMeetingSizeExceeded" />
    <xs:enumeration value="mcuTypeNotAvailable" />
    <xs:enumeration value="maxConferencesExceeded" />
    <xs:enumeration value="notificationDataTooLarge" />
    <xs:enumeration value="organizerRoamingDataTooLarge" />
    <!-- conferenceDoesntExist only applies to modifyConference responses -->
    <xs:enumeration value="conferenceDoesntExist" />
    <!-- invalidVersion only applies to modifyConference responses -->
    <xs:enumeration value="invalidVersion" />
    <!-- activeMediaDeletionForbidden only applies to modifyConference responses -->
    <xs:enumeration value="activeMediaDeletionForbidden" />
    <xs:enumeration value="pstnBridgeNotEnabled" />
    <xs:enumeration value="pstnMeetingIdCannotBeSpecified" />
    <xs:enumeration value="optionalPasscodeForbidden" />
    <xs:enumeration value="meetingValidationFailed" />
    <xs:enumeration value="invalidAutopromoteValue" />
    <xs:enumeration value="pstnLobbyBypassNotAllowed" />
    <xs:enumeration value="maxStaticMeetingsExceeded" />
    <xs:enumeration value="invalidStaticMeetingRequest" />
    <xs:enumeration value="otherFailure" />
  </xs:restriction>
</xs:simpleType>

<!-- GET AVAILABLE MCU TYPES TYPE -->
<xs:complexType name="get-available-mcu-types-type">
  <xs:sequence>
    <xs:any namespace="##other" processContents="lax" minOccurs="0"
maxOccurs="unbounded"/>
  </xs:sequence>
  <xs:attribute name="server-mode" type="xs:unsignedInt" use="optional" default="14"/>
  <xs:anyAttribute namespace="##other" processContents="lax"/>
</xs:complexType>

<xs:complexType name="mcu-types-type">
  <xs:sequence>
    <xs:element name="mcuType" type="xs:string" minOccurs="0" maxOccurs="unbounded"/>
    <xs:any namespace="##other" processContents="lax" minOccurs="0"
maxOccurs="unbounded"/>
  </xs:sequence>
  <xs:anyAttribute namespace="##other" processContents="lax"/>
</xs:complexType>

<!-- GET AVAILABLE MCU TYPES RESPONSE TYPE -->
<xs:complexType name="get-available-mcu-types-response-type">
  <xs:sequence>
    <xs:element ref="mscp:diagnostics-info" minOccurs="0"/>
    <xs:element name="mcu-types" type="tns:mcu-types-type"/>
    <xs:sequence minOccurs="0">
      <xs:element ref="cis:separator" />
      <xs:any namespace="##other" processContents="lax" maxOccurs="unbounded" />
    </xs:sequence>
  </xs:sequence>
</xs:complexType>

```

```

    <xs:attribute name="reason" type="tns:get-available-mcu-types-reason-code-type-ex"
use="optional"/>
    <xs:anyAttribute namespace="##other" processContents="lax"/>
  </xs:complexType>

  <!-- GET AVAILABLE MCU TYPES REASON CODE TYPE -->
  <xs:simpleType name="get-available-mcu-types-reason-code-type-ex">
    <xs:union memberTypes="tns:get-available-mcu-types-reason-code-type xs:string"/>
  </xs:simpleType>

  <xs:simpleType name="get-available-mcu-types-reason-code-type">
    <xs:restriction base="xs:string">
      <xs:enumeration value="otherFailure"/>
    </xs:restriction>
  </xs:simpleType>

  <!-- GET CONFERENCE TYPE -->
  <xs:complexType name="get-conference-type">
    <xs:sequence>
      <xs:element name="conferenceKeys" type="tns:conference-keys-type"/>
      <xs:element name="notify" type="xs:boolean" minOccurs="0"/>
      <xs:element ref="msci:encryption-key" minOccurs="0"/>
      <xs:sequence minOccurs="0">
        <xs:element ref="cis:separator"/>
        <xs:any namespace="##other" processContents="lax" maxOccurs="unbounded"/>
      </xs:sequence>
    </xs:sequence>
    <xs:anyAttribute namespace="##other" processContents="lax" />
  </xs:complexType>

  <!-- GET CONFERENCE RESPONSE TYPE -->
  <xs:complexType name="get-conference-response-type">
    <xs:sequence>
      <xs:element ref="mscp:diagnostics-info" minOccurs="0"/>
      <xs:element ref="ci:conference-info" minOccurs="0"/>
      <xs:sequence minOccurs="0">
        <xs:element ref="cis:separator" />
        <xs:any namespace="##other" processContents="lax" maxOccurs="unbounded" />
      </xs:sequence>
      <xs:attribute name="reason" type="tns:get-conference-reason-code-type-ex"
use="optional"/>
      <xs:anyAttribute namespace="##other" processContents="lax" />
    </xs:complexType>

  <!-- GET CONFERENCE REASON CODE TYPE -->
  <xs:simpleType name="get-conference-reason-code-type-ex">
    <xs:union memberTypes="tns:get-conference-reason-code-type xs:string"/>
  </xs:simpleType>

  <xs:simpleType name="get-conference-reason-code-type">
    <xs:restriction base="xs:string">
      <xs:enumeration value="conferenceDoesntExist" />
      <xs:enumeration value="invalidEncryptionKey" />
      <xs:enumeration value="otherFailure" />
    </xs:restriction>
  </xs:simpleType>

  <!-- GET CONFERENCES TYPE -->
  <xs:complexType name="get-conferences-type">
    <xs:sequence>
      <xs:any namespace="##other" processContents="lax" minOccurs="0"
maxOccurs="unbounded"/>
    </xs:sequence>
    <xs:attribute name="static" type="xs:boolean" use="optional"/>
    <xs:anyAttribute namespace="##other" processContents="lax"/>
  </xs:complexType>

  <xs:complexType name="conferences-type">

```



```

<xs:sequence>
  <xs:element ref="ci:conference-info" minOccurs="0" maxOccurs="unbounded"/>
  <xs:sequence minOccurs="0">
    <xs:element ref="cis:separator"/>
    <xs:any namespace="##other" processContents="lax" maxOccurs="unbounded"/>
  </xs:sequence>
</xs:sequence>
<xs:anyAttribute namespace="##other" processContents="lax"/>
</xs:complexType>

<!-- GET CONFERENCES RESPONSE TYPE -->
<xs:complexType name="get-conferences-response-type">
  <xs:sequence>
    <xs:element ref="mscp:diagnostics-info" minOccurs="0"/>
    <xs:element name="conferences" type="tns:conferences-type"/>
    <xs:sequence minOccurs="0">
      <xs:element ref="cis:separator" />
      <xs:any namespace="##other" processContents="lax" maxOccurs="unbounded" />
    </xs:sequence>
  </xs:sequence>
  <xs:attribute name="reason" type="tns:get-conferences-reason-code-type-ex"
use="optional"/>
  <xs:attribute name="static" type="xs:boolean" use="optional"/>
  <xs:anyAttribute namespace="##other" processContents="lax"/>
</xs:complexType>

<!-- GET CONFERENCES REASON CODE TYPE -->
<xs:simpleType name="get-conferences-reason-code-type-ex">
  <xs:union memberTypes="tns:get-conferences-reason-code-type xs:string"/>
</xs:simpleType>

<xs:simpleType name="get-conferences-reason-code-type">
  <xs:restriction base="xs:string">
    <xs:enumeration value="otherFailure"/>
  </xs:restriction>
</xs:simpleType>

<!-- GET ENCRYPTION KEY TYPE -->
<xs:complexType name="get-encryption-key-type">
  <xs:sequence>
    <xs:any namespace="##other" processContents="lax" minOccurs="0"
maxOccurs="unbounded"/>
  </xs:sequence>
  <xs:anyAttribute namespace="##other" processContents="lax"/>
</xs:complexType>

<!-- GET ENCRYPTION KEY RESPONSE TYPE -->
<xs:complexType name="get-encryption-key-response-type">
  <xs:sequence>
    <xs:element ref="mscp:diagnostics-info" minOccurs="0"/>
    <xs:element ref="msci:encryption-key"/>
    <xs:element ref="msci:opaque" minOccurs="0" />
    <xs:sequence minOccurs="0">
      <xs:element ref="cis:separator" />
      <xs:any namespace="##other" processContents="lax" maxOccurs="unbounded" />
    </xs:sequence>
  </xs:sequence>
  <xs:attribute name="reason" type="tns:get-encryption-key-reason-code-type-ex"
use="optional"/>
  <xs:anyAttribute namespace="##other" processContents="lax"/>
</xs:complexType>

<!-- GET ENCRYPTION KEY REASON CODE TYPE -->
<xs:simpleType name="get-encryption-key-reason-code-type-ex">
  <xs:union memberTypes="tns:get-encryption-key-reason-code-type xs:string"/>
</xs:simpleType>

<xs:simpleType name="get-encryption-key-reason-code-type">
  <xs:restriction base="xs:string">

```

```

        <xs:enumeration value="otherFailure"/>
    </xs:restriction>
</xs:simpleType>

<!-- DELETE CONFERENCE TYPE -->
<xs:complexType name="delete-conference-type">
    <xs:sequence>
        <xs:element name="conferenceKeys" type="tns:conference-keys-type"/>
        <xs:any namespace="##other" processContents="lax" minOccurs="0"
maxOccurs="unbounded" />
    </xs:sequence>
    <xs:attribute name="static" type="xs:boolean" use="optional"/>
    <xs:anyAttribute namespace="##other" processContents="lax" />
</xs:complexType>

<!-- DELETE CONFERENCE RESPONSE TYPE -->
<xs:complexType name="delete-conference-response-type">
    <xs:sequence>
        <xs:element ref="mscp:diagnostics-info" minOccurs="0"/>
        <xs:element ref="ci:conference-info" minOccurs="0"/>
        <xs:sequence minOccurs="0">
            <xs:element ref="cis:separator" />
            <xs:any namespace="##other" processContents="lax" maxOccurs="unbounded" />
        </xs:sequence>
    </xs:sequence>
    <xs:attribute name="reason" type="tns:delete-conference-reason-code-type-ex"
use="optional"/>
    <xs:anyAttribute namespace="##other" processContents="lax" />
</xs:complexType>

<!-- DELETE CONFERENCE REASON CODE TYPE -->
<xs:simpleType name="delete-conference-reason-code-type-ex">
    <xs:union memberTypes="tns:delete-conference-reason-code-type xs:string"/>
</xs:simpleType>

<xs:simpleType name="delete-conference-reason-code-type">
    <xs:restriction base="xs:string">
        <xs:enumeration value="conferenceDoesntExist" />
        <xs:enumeration value="staticFlagDoesntMatch" />
        <xs:enumeration value="otherFailure" />
    </xs:restriction>
</xs:simpleType>

<!-- MEDIA DESCRIPTION TYPE -->
<xs:complexType name="media-description-type">
    <xs:attribute name="modality" type="xs:string"/>
    <xs:attribute name="vendor" type="xs:string"/>
    <xs:anyAttribute namespace="##other" processContents="lax" />
</xs:complexType>

<!-- DELETE CONFERENCES TYPE -->
<xs:complexType name="delete-conferences-type">
    <xs:sequence>
        <xs:element name="server" type="tns:media-description-type" minOccurs="0"/>
        <xs:any namespace="##other" processContents="lax" minOccurs="0"
maxOccurs="unbounded" />
    </xs:sequence>
    <xs:attribute name="poolFqdn" type="xs:string"/>
    <xs:anyAttribute namespace="##other" processContents="lax" />
</xs:complexType>

<!-- DELETE CONFERENCES RESPONSE TYPE -->
<xs:complexType name="delete-conferences-response-type">
    <xs:sequence>
        <xs:element ref="mscp:diagnostics-info" minOccurs="0"/>
        <xs:element name="server" type="tns:media-description-type" minOccurs="0"/>
        <xs:sequence minOccurs="0">
            <xs:element ref="cis:separator" />
            <xs:any namespace="##other" processContents="lax" maxOccurs="unbounded" />
        </xs:sequence>
    </xs:sequence>

```

```

        </xs:sequence>
    </xs:sequence>
    <xs:attribute name="reason" type="tns:delete-conferences-reason-code-type-ex"
use="optional"/>
    <xs:anyAttribute namespace="##other" processContents="lax" />
</xs:complexType>

<!-- DELETE CONFERENCES REASON CODE TYPE -->
<xs:simpleType name="delete-conferences-reason-code-type-ex">
    <xs:union memberTypes="tns:delete-conferences-reason-code-type xs:string"/>
</xs:simpleType>

<xs:simpleType name="delete-conferences-reason-code-type">
    <xs:restriction base="xs:string">
        <xs:enumeration value="timeout" />
        <xs:enumeration value="otherFailure" />
    </xs:restriction>
</xs:simpleType>

<!-- MODIFY CONFERENCE REASON CODE TYPE -->
<xs:simpleType name="modify-conference-reason-code-type-ex">
    <xs:union memberTypes="tns:modify-conference-reason-code-type xs:string"/>
</xs:simpleType>

<xs:simpleType name="modify-conference-reason-code-type">
    <xs:restriction base="xs:string">
        <xs:enumeration value="conferenceDoesntExist" />
        <xs:enumeration value="mediaNotSupported" />
        <xs:enumeration value="otherFailure" />
    </xs:restriction>
</xs:simpleType>

<!-- MODIFY CONFERENCE LOCK TYPE -->
<xs:complexType name="modify-conference-lock-type">
    <xs:sequence>
        <xs:element name="conferenceKeys" type="tns:conference-keys-type"/>
        <xs:element name="locked" type="xs:boolean"/>
        <xs:sequence minOccurs="0">
            <xs:element ref="cis:separator" />
            <xs:element ref="msci:admission-policy" minOccurs="0"/>
            <xs:element ref="msci:autopromote" minOccurs="0"/>
            <xs:element ref="msci:pstn-lobby-bypass" minOccurs="0"/>
            <xs:sequence minOccurs="0">
                <xs:element ref="cis:separator" />
                <xs:any namespace="##other" processContents="lax" maxOccurs="unbounded" />
            </xs:sequence>
        </xs:sequence>
    </xs:sequence>
    <xs:anyAttribute namespace="##other" processContents="lax" />
</xs:complexType>

<!-- MODIFY CONFERENCE LOCK RESPONSE TYPE -->
<xs:complexType name="modify-conference-lock-response-type">
    <xs:sequence>
        <xs:element ref="mscp:diagnostics-info" minOccurs="0"/>
        <xs:element ref="ci:conference-info" minOccurs="0"/>
        <xs:element name="locked" type="xs:boolean" minOccurs="0"/>
        <xs:sequence minOccurs="0">
            <xs:element ref="cis:separator" />
            <xs:element ref="msci:admission-policy" minOccurs="0"/>
            <xs:element ref="msci:autopromote" minOccurs="0"/>
            <xs:element ref="msci:pstn-lobby-bypass" minOccurs="0"/>
            <xs:sequence minOccurs="0">
                <xs:element ref="cis:separator" />
                <xs:any namespace="##other" processContents="lax" maxOccurs="unbounded" />
            </xs:sequence>
        </xs:sequence>
    </xs:sequence>
</xs:complexType>

```

```

    <xs:attribute name="reason" type="tns:modify-conference-lock-reason-code-type-ex"
use="optional"/>
    <xs:anyAttribute namespace="##other" processContents="lax" />
  </xs:complexType>

<!-- MODIFY CONFERENCE LOCK REASON CODE TYPE -->
<xs:simpleType name="modify-conference-lock-reason-code-type-ex">
  <xs:union memberTypes="tns:modify-conference-lock-reason-code-type xs:string"/>
</xs:simpleType>

<xs:simpleType name="modify-conference-lock-reason-code-type">
  <xs:restriction base="xs:string">
    <xs:enumeration value="conferenceDoesntExist" />
    <xs:enumeration value="accessTypeNotAllowed" />
    <xs:enumeration value="invalidAutopromoteValue" />
    <xs:enumeration value="pstnLobbyBypassNotAllowed" />
    <xs:enumeration value="otherFailure" />
  </xs:restriction>
</xs:simpleType>

<!-- ENDORSE USER TYPE -->
<xs:complexType name="endorse-user-type">
  <xs:sequence>
    <xs:element name="conferenceKeys" type="tns:conference-keys-type"/>
    <xs:element name="endorsee" type="xs:anyURI"/>
    <xs:element ref="ci:dialog-id"/>
    <xs:sequence minOccurs="0">
      <xs:element ref="cis:separator" />
      <xs:any namespace="##other" processContents="lax" maxOccurs="unbounded" />
    </xs:sequence>
  </xs:sequence>
  <xs:anyAttribute namespace="##other" processContents="lax" />
</xs:complexType>

<!-- ENDORSE USER RESPONSE TYPE -->
<xs:complexType name="endorse-user-response-type">
  <xs:sequence>
    <xs:element name="conferenceKeys" type="tns:conference-keys-type" minOccurs="0"/>
    <xs:element ref="mscp:diagnostics-info" minOccurs="0"/>
    <xs:sequence minOccurs="0">
      <xs:element ref="cis:separator" />
      <xs:any namespace="##other" processContents="lax" maxOccurs="unbounded" />
    </xs:sequence>
  </xs:sequence>
  <xs:attribute name="result" type="tns:endorse-user-result-code-type-ex"
use="optional"/>
  <xs:anyAttribute namespace="##other" processContents="lax" />
</xs:complexType>

<!-- ENDORSE USER RESULT CODE TYPE -->
<xs:simpleType name="endorse-user-result-code-type-ex">
  <xs:union memberTypes="tns:endorse-user-result-code-type xs:string"/>
</xs:simpleType>

<xs:simpleType name="endorse-user-result-code-type">
  <xs:restriction base="xs:string">
    <xs:enumeration value="success" />
    <xs:enumeration value="otherFailure" />
  </xs:restriction>
</xs:simpleType>

<!-- ADD USER TYPE -->
<xs:complexType name="add-user-type">
  <xs:sequence>
    <xs:element name="conferenceKeys" type="tns:conference-keys-type"/>
    <xs:element ref="ci:user"/>
    <xs:any namespace="##other" processContents="lax" minOccurs="0"
maxOccurs="unbounded" />
  </xs:sequence>

```

```

    <xs:attribute ref="mscp:allow-session-replace" use="optional" default="false"/>
    <xs:attribute ref="mscp:mcuUri" use="optional"/>
    <xs:anyAttribute namespace="##other" processContents="lax" />
</xs:complexType>

<!-- ADD USER RESPONSE TYPE -->
<xs:complexType name="add-user-response-type">
  <xs:sequence>
    <xs:element ref="mscp:diagnostics-info" minOccurs="0"/>
    <xs:element name="conferenceKeys" type="tns:conference-keys-type" minOccurs="0"/>
    <xs:element ref="ci:user" minOccurs="0"/>
    <xs:element ref="mscp:info" minOccurs="0"/>
    <xs:element ref="mscp:connection-info" minOccurs="0"/>
    <xs:sequence minOccurs="0">
      <xs:element ref="cis:separator" />
      <xs:any namespace="##other" processContents="lax" maxOccurs="unbounded" />
    </xs:sequence>
  </xs:sequence>
  <xs:attribute name="reason" type="tns:add-user-reason-code-type-ex" use="optional"/>
  <xs:attribute ref="mscp:mcuUri" use="optional"/>
  <xs:anyAttribute namespace="##other" processContents="lax" />
</xs:complexType>

<!-- ADD USER REASON CODE TYPE -->
<xs:simpleType name="add-user-reason-code-type-ex">
  <xs:union memberTypes="tns:add-user-reason-code-type xs:string"/>
</xs:simpleType>

<xs:simpleType name="add-user-reason-code-type">
  <xs:restriction base="xs:string">
    <xs:enumeration value="conferenceDoesntExist" />
    <xs:enumeration value="userExistsAlready" />
    <xs:enumeration value="userDoesntExist" />
    <xs:enumeration value="userBusy" />
    <xs:enumeration value="userNotAnswered" />
    <xs:enumeration value="userDeclined" />
    <xs:enumeration value="userUnknown" />
    <xs:enumeration value="recordingNotAllowed" />
    <xs:enumeration value="otherFailure" />
    <xs:enumeration value="conferenceShutdown" />
    <xs:enumeration value="userDeleted" />
    <xs:enumeration value="userReplaced" />
  </xs:restriction>
</xs:simpleType>

<!-- VERIFY CONFERENCE KEY USER TYPE -->
<xs:complexType name="verify-confkey-type">
  <xs:sequence>
    <xs:element name="conferenceKeys" type="tns:conference-keys-type"/>
    <xs:element ref="msci:conference-key"/>
  </xs:sequence>
  <xs:anyAttribute namespace="##other" processContents="lax" />
</xs:complexType>

<!-- VERIFY CONFERENCE KEY RESPONSE TYPE -->
<xs:complexType name="verify-confkey-response-type">
  <xs:sequence>
    <xs:element ref="mscp:diagnostics-info" minOccurs="0"/>
  </xs:sequence>
  <xs:attribute name="reason" type="tns:verify-confkey-reason-code-type-ex"
use="optional"/>
  <xs:anyAttribute namespace="##other" processContents="lax"/>
</xs:complexType>

<!-- VERIFY CONFERENCE KEY REASON CODE TYPE -->
<xs:simpleType name="verify-confkey-reason-code-type-ex">
  <xs:union memberTypes="tns:verify-confkey-reason-code-type xs:string"/>
</xs:simpleType>

```

```

<xs:simpleType name="verify-confkey-reason-code-type">
  <xs:restriction base="xs:string">
    <xs:enumeration value="incorrectConferenceKey" />
    <xs:enumeration value="invalidEncryptionKeyUsed" />
    <xs:enumeration value="anonymousUsersNotAllowed" />
    <xs:enumeration value="conferenceDoesntExist" />
    <xs:enumeration value="requestMalformed" />
    <xs:enumeration value="unauthorized" />
    <xs:enumeration value="otherFailure" />
  </xs:restriction>
</xs:simpleType>

<!-- MODIFY USER ROLES TYPE -->
<xs:complexType name="modify-user-roles-type">
  <xs:sequence>
    <xs:element name="userKeys" type="tns:user-keys-type"/>
    <xs:element ref="ci:user-roles"/>
    <xs:any namespace="##other" processContents="lax" minOccurs="0"
maxOccurs="unbounded" />
  </xs:sequence>
  <xs:attribute ref="mscp:mcuUri" use="optional" />
  <xs:anyAttribute namespace="##other" processContents="lax" />
</xs:complexType>

<!-- MODIFY USER ROLES RESPONSE TYPE -->
<xs:complexType name="modify-user-roles-response-type">
  <xs:sequence>
    <xs:element ref="mscp:diagnostics-info" minOccurs="0"/>
    <xs:element name="conferenceKeys" type="tns:conference-keys-type" minOccurs="0"/>
    <xs:element ref="ci:user" minOccurs="0"/>
    <xs:sequence minOccurs="0">
      <xs:element ref="cis:separator" />
      <xs:any namespace="##other" processContents="lax" maxOccurs="unbounded" />
    </xs:sequence>
  </xs:sequence>
  <xs:attribute name="reason" type="tns:modify-user-roles-reason-code-type-ex"
use="optional"/>
  <xs:attribute ref="mscp:mcuUri" use="optional"/>
  <xs:anyAttribute namespace="##other" processContents="lax"/>
</xs:complexType>

<!-- MODIFY USER ROLES REASON CODE TYPE -->
<xs:simpleType name="modify-user-roles-reason-code-type-ex">
  <xs:union memberTypes="tns:modify-user-roles-reason-code-type xs:string"/>
</xs:simpleType>

<xs:simpleType name="modify-user-roles-reason-code-type">
  <xs:restriction base="xs:string">
    <xs:enumeration value="conferenceDoesntExist"/>
    <xs:enumeration value="userDoesntExist"/>
    <xs:enumeration value="otherFailure"/>
  </xs:restriction>
</xs:simpleType>

<!-- DELETE USER TYPE -->
<xs:complexType name="delete-user-type">
  <xs:sequence>
    <xs:element name="userKeys" type="tns:user-keys-type"/>
    <xs:element name="endpointEntity" type="xs:string" minOccurs="0"/>
    <xs:element ref="mscp:reason" minOccurs="0" />
    <xs:sequence minOccurs="0">
      <xs:element ref="cis:separator" />
      <xs:any namespace="##other" processContents="lax" maxOccurs="unbounded" />
    </xs:sequence>
  </xs:sequence>
  <xs:attribute ref="mscp:mcuUri" use="optional"/>
  <xs:attribute name="client-reason" type="tns:delete-user-client-reason-code-type-ext"
use="optional"/>

```

```

    <xs:anyAttribute namespace="##other" processContents="lax" />
  </xs:complexType>

  <!-- rename this type to -ext so that it is not processed by the perl script that will
essentially
    remove the union attribute that preserves back compat -->
  <!-- DELETE USER CLIENT REASON TYPE -->
  <xs:simpleType name="delete-user-client-reason-code-type-ext">
    <xs:union memberTypes="tns:delete-user-client-reason-code-type xs:string"/>
  </xs:simpleType>

  <xs:simpleType name="delete-user-client-reason-code-type">
    <xs:restriction base="xs:string">
      <xs:enumeration value="newPresenter" />
      <xs:enumeration value="participantEjected" />
      <xs:enumeration value="connectedAtAnotherEndpoint" />
    </xs:restriction>
  </xs:simpleType>

  <!-- DELETE USER RESPONSE TYPE -->
  <xs:complexType name="delete-user-response-type">
    <xs:sequence>
      <xs:element ref="mscp:diagnostics-info" minOccurs="0"/>
      <xs:element name="conferenceKeys" type="tns:conference-keys-type" minOccurs="0"/>
      <xs:element ref="ci:user" minOccurs="0" />
      <xs:sequence minOccurs="0">
        <xs:element ref="cis:separator" />
        <xs:any namespace="##other" processContents="lax" maxOccurs="unbounded" />
      </xs:sequence>
    </xs:sequence>
    <xs:attribute name="reason" type="tns:delete-user-reason-code-type-ex"
use="optional"/>
    <xs:attribute ref="mscp:mcuUri" use="optional" />
    <xs:anyAttribute namespace="##other" processContents="lax" />
  </xs:complexType>

  <!-- DELETE USER REASON CODE TYPE -->
  <xs:simpleType name="delete-user-reason-code-type-ex">
    <xs:union memberTypes="tns:delete-user-reason-code-type xs:string"/>
  </xs:simpleType>

  <xs:simpleType name="delete-user-reason-code-type">
    <xs:restriction base="xs:string">
      <xs:enumeration value="conferenceDoesntExist" />
      <xs:enumeration value="userDoesntExist" />
      <xs:enumeration value="otherFailure" />
    </xs:restriction>
  </xs:simpleType>

  <!-- SET USER ACCESS TYPE -->
  <xs:complexType name="set-user-access-type">
    <xs:sequence>
      <xs:element name="userKeys" type="tns:user-keys-type"/>
      <xs:element name="access" type="tns:user-access-type"/>
      <xs:sequence minOccurs="0">
        <xs:element ref="cis:separator" />
        <xs:any namespace="##other" processContents="lax" maxOccurs="unbounded" />
      </xs:sequence>
    </xs:sequence>
    <xs:attribute ref="mscp:mcuUri" use="optional" />
    <xs:anyAttribute namespace="##other" processContents="lax" />
  </xs:complexType>

  <!-- SET USER ACCESS RESPONSE TYPE -->
  <xs:complexType name="set-user-access-response-type">
    <xs:sequence>
      <xs:element ref="mscp:diagnostics-info" minOccurs="0"/>
      <xs:element name="conferenceKeys" type="tns:conference-keys-type" minOccurs="0"/>
      <xs:element ref="ci:user" minOccurs="0"/>

```

```

        <xs:sequence minOccurs="0">
            <xs:element ref="cis:separator" />
            <xs:any namespace="##other" processContents="lax" maxOccurs="unbounded" />
        </xs:sequence>
    </xs:sequence>
    <xs:attribute name="reason" type="tns:set-user-access-reason-code-type-ex"
use="optional"/>
    <xs:attribute ref="mscp:mcuUri" use="optional" />
    <xs:anyAttribute namespace="##other" processContents="lax" />
</xs:complexType>

<!-- SET USER ACCESS REASON CODE TYPE -->
<xs:simpleType name="set-user-access-reason-code-type-ex">
    <xs:union memberTypes="tns:set-user-access-reason-code-type xs:string"/>
</xs:simpleType>

<xs:simpleType name="set-user-access-reason-code-type">
    <xs:restriction base="xs:string">
        <xs:enumeration value="conferenceDoesntExist" />
        <xs:enumeration value="userDoesntExist" />
        <xs:enumeration value="otherFailure" />
    </xs:restriction>
</xs:simpleType>

<!-- SET LOBBY ACCESS TYPE -->
<xs:complexType name="set-lobby-access-type">
    <xs:sequence>
        <xs:element name="conferenceKeys" type="tns:conference-keys-type"/>
        <xs:element name="userEntity" type="xs:anyURI" maxOccurs="unbounded"/>
        <xs:element name="access" type="tns:user-access-type"/>
        <xs:sequence minOccurs="0">
            <xs:element ref="cis:separator" />
            <xs:any namespace="##other" processContents="lax" maxOccurs="unbounded" />
        </xs:sequence>
    </xs:sequence>
    <xs:attribute ref="mscp:mcuUri" use="optional" />
    <xs:anyAttribute namespace="##other" processContents="lax" />
</xs:complexType>

<!-- SET LOBBY ACCESS RESPONSE TYPE -->
<xs:complexType name="set-lobby-access-response-type">
    <xs:sequence>
        <xs:element ref="mscp:diagnostics-info" minOccurs="0"/>
        <xs:element name="conferenceKeys" type="tns:conference-keys-type" minOccurs="0"/>
        <xs:element name="status" type="tns:set-lobby-access-status-type" minOccurs="0"
maxOccurs="unbounded"/>
        <xs:sequence minOccurs="0">
            <xs:element ref="cis:separator" />
            <xs:any namespace="##other" processContents="lax" maxOccurs="unbounded" />
        </xs:sequence>
    </xs:sequence>
    <xs:attribute name="reason" type="tns:set-lobby-access-reason-code-type-ex"
use="optional"/>
    <xs:attribute ref="mscp:mcuUri" use="optional" />
    <xs:anyAttribute namespace="##other" processContents="lax" />
</xs:complexType>

<!-- SET LOBBY ACCESS STATUS TYPE -->
<xs:complexType name="set-lobby-access-status-type">
    <xs:sequence>
        <xs:element name="userEntity" type="xs:anyURI"/>
        <xs:sequence minOccurs="0">
            <xs:element ref="cis:separator" />
            <xs:any namespace="##other" processContents="lax" maxOccurs="unbounded" />
        </xs:sequence>
    </xs:sequence>
    <xs:attribute name="reason" type="tns:set-lobby-access-status-code-type-ex"/>
    <xs:anyAttribute namespace="##other" processContents="lax" />
</xs:complexType>

```



```

<!-- SET LOBBY ACCESS STATUS CODE TYPE -->
<xs:simpleType name="set-lobby-access-status-code-type-ex">
  <xs:union memberTypes="tns:set-lobby-access-status-code-type xs:string"/>
</xs:simpleType>

<xs:simpleType name="set-lobby-access-status-code-type">
  <xs:restriction base="xs:string">
    <xs:enumeration value="conferenceFull" />
    <xs:enumeration value="userDoesntExist" />
    <xs:enumeration value="alreadyGranted" />
    <xs:enumeration value="success" />
  </xs:restriction>
</xs:simpleType>

<!-- SET LOBBY ACCESS REASON CODE TYPE -->
<xs:simpleType name="set-lobby-access-reason-code-type-ex">
  <xs:union memberTypes="tns:set-lobby-access-reason-code-type xs:string"/>
</xs:simpleType>

<xs:simpleType name="set-lobby-access-reason-code-type">
  <xs:restriction base="xs:string">
    <xs:enumeration value="conferenceDoesntExist" />
    <xs:enumeration value="notAuthorized" />
    <xs:enumeration value="otherFailure" />
  </xs:restriction>
</xs:simpleType>

<!-- USER ACCESS TYPE -->
<xs:simpleType name="user-access-type">
  <xs:restriction base="xs:string">
    <xs:enumeration value="granted" />
    <xs:enumeration value="denied" />
  </xs:restriction>
</xs:simpleType>

<!-- MODIFY ENDPOINT TYPE -->
<xs:complexType name="modify-endpoint-type">
  <xs:sequence>
    <xs:element name="endpointKeys" type="tns:endpoint-keys-type"/>
    <xs:element ref="ci:endpoint"/>
    <xs:any namespace="##other" processContents="lax" minOccurs="0"
maxOccurs="unbounded" />
  </xs:sequence>
  <xs:attribute ref="mscp:mcuUri" use="optional"/>
  <xs:anyAttribute namespace="##other" processContents="lax" />
</xs:complexType>

<!-- MODIFY ENDPOINT RESPONSE TYPE -->
<xs:complexType name="modify-endpoint-response-type">
  <xs:sequence>
    <xs:element ref="mscp:diagnostics-info" minOccurs="0"/>
    <xs:element name="endpointKeys" type="tns:endpoint-keys-type" minOccurs="0"/>
    <xs:element ref="ci:endpoint" minOccurs="0"/>
    <xs:sequence minOccurs="0">
      <xs:element ref="cis:separator" />
      <xs:any namespace="##other" processContents="lax" maxOccurs="unbounded" />
    </xs:sequence>
  </xs:sequence>
  <xs:attribute name="reason" type="tns:modify-endpoint-reason-code-type-ex"
use="optional"/>
  <xs:attribute ref="mscp:mcuUri" use="optional"/>
  <xs:anyAttribute namespace="##other" processContents="lax" />
</xs:complexType>

<xs:simpleType name="modify-endpoint-reason-code-type-ex">
  <xs:union memberTypes="tns:modify-endpoint-reason-code-type xs:string"/>
</xs:simpleType>

```

```

<xs:simpleType name="modify-endpoint-reason-code-type">
  <xs:restriction base="xs:string">
    <xs:enumeration value="conferenceDoesntExist" />
    <xs:enumeration value="userDoesntExist" />
    <xs:enumeration value="endpointDoesntExist" />
    <xs:enumeration value="recordingNotAllowed"/>
    <xs:enumeration value="otherFailure" />
  </xs:restriction>
</xs:simpleType>

<!-- MODIFY ENDPOINT ROLE TYPE -->
<xs:complexType name="modify-endpoint-role-type">
  <xs:sequence>
    <xs:element name="endpointKeys" type="tns:endpoint-keys-type"/>
    <xs:element ref="ci:user-roles" minOccurs="0" />
    <xs:element ref="msci:pstnRole" minOccurs="0" />
    <xs:sequence minOccurs="0">
      <xs:element ref="cis:separator"/>
      <xs:any namespace="##other" processContents="lax" maxOccurs="unbounded"/>
    </xs:sequence>
  </xs:sequence>
  <xs:attribute ref="mscp:mcuUri" use="optional"/>
  <xs:anyAttribute namespace="##other" processContents="lax" />
</xs:complexType>

<!-- MODIFY ENDPOINT ROLE RESPONSE TYPE -->
<xs:complexType name="modify-endpoint-role-response-type">
  <xs:sequence>
    <xs:element ref="mscp:diagnostics-info" minOccurs="0"/>
    <xs:element name="endpointKeys" type="tns:endpoint-keys-type" minOccurs="0" />
    <xs:element ref="ci:user-roles" minOccurs="0" />
    <xs:element ref="msci:pstnRole" minOccurs="0" />
    <xs:sequence minOccurs="0">
      <xs:element ref="cis:separator" />
      <xs:any namespace="##other" processContents="lax" maxOccurs="unbounded" />
    </xs:sequence>
  </xs:sequence>
  <xs:attribute name="reason" type="tns:modify-endpoint-role-reason-code-type-ex"
use="optional"/>
  <xs:attribute ref="mscp:mcuUri" use="optional" />
  <xs:anyAttribute namespace="##other" processContents="lax" />
</xs:complexType>

<!-- MODIFY ENDPOINT ROLE REASON CODE TYPE -->
<xs:simpleType name="modify-endpoint-role-reason-code-type-ex">
  <xs:union memberTypes="tns:modify-endpoint-role-reason-code-type xs:string"/>
</xs:simpleType>

<xs:simpleType name="modify-endpoint-role-reason-code-type">
  <xs:restriction base="xs:string">
    <xs:enumeration value="conferenceDoesntExist" />
    <xs:enumeration value="userDoesntExist" />
    <xs:enumeration value="endpointDoesntExist" />
    <xs:enumeration value="otherFailure" />
  </xs:restriction>
</xs:simpleType>

<!-- MODIFY USERS MEDIA FILTERS TYPE -->
<xs:complexType name="modify-users-media-filters-type">
  <xs:sequence>
    <xs:element name="conferenceKeys" type="tns:conference-keys-type"/>
    <xs:element name="mediaLabel" type="xs:string" maxOccurs="unbounded"/>
    <xs:element ref="msci:media-ingress-filter" minOccurs="0" />
    <xs:element ref="msci:media-egress-filter" minOccurs="0" />
    <!-- zero or more "excludeRole" elements specifies the roles to which this filter
should NOT be applied (i.e. leave them untouched) -->
    <xs:element name="excludeRole" type="xs:string" minOccurs="0"
maxOccurs="unbounded"/>
  </xs:sequence>
</xs:complexType>

```

```

    <!-- zero or more "excludeUser" elements specify users to which this filter should
NOT be applied(i.e. leave them untouched) -->
    <xs:element name="excludeUser" type="xs:anyURI" minOccurs="0"
maxOccurs="unbounded"/>
    <xs:sequence minOccurs="0">
        <xs:element ref="cis:separator" />
        <xs:any namespace="##other" processContents="lax" maxOccurs="unbounded" />
    </xs:sequence>
</xs:sequence>
<xs:attribute ref="mscp:mcuUri" use="optional"/>
<xs:anyAttribute namespace="##other" processContents="lax" />
</xs:complexType>

<!-- MODIFY USERS MEDIA FILTERS RESPONSE TYPE -->
<xs:complexType name="modify-users-media-filters-response-type">
    <xs:sequence>
        <xs:element ref="mscp:diagnostics-info" minOccurs="0"/>
        <!-- Correlation token -->
        <xs:element name="conferenceKeys" type="tns:conference-keys-type" />
        <!-- Failures -->
        <xs:element name="unsupportedRole" type="xs:string" minOccurs="0"
maxOccurs="unbounded"/>
        <xs:element name="unknownUser" type="xs:anyURI" minOccurs="0"
maxOccurs="unbounded"/>
        <xs:element name="unsupportedMediaLabel" type="xs:string" minOccurs="0"
maxOccurs="unbounded"/>
        <xs:sequence minOccurs="0">
            <xs:element ref="cis:separator" />
            <xs:any namespace="##other" processContents="lax" maxOccurs="unbounded" />
        </xs:sequence>
    </xs:sequence>
    <xs:attribute name="reason" type="tns:modify-users-media-filters-reason-code-type-ex"
use="optional"/>
    <xs:attribute ref="mscp:mcuUri" use="optional" />
    <xs:anyAttribute namespace="##other" processContents="lax" />
</xs:complexType>

<!-- MODIFY USERS MEDIA FILTERS REASON CODE TYPE -->
<xs:simpleType name="modify-users-media-filters-reason-code-type-ex">
    <xs:union memberTypes="tns:modify-users-media-filters-reason-code-type xs:string"/>
</xs:simpleType>

<xs:simpleType name="modify-users-media-filters-reason-code-type">
    <xs:restriction base="xs:string">
        <xs:enumeration value="conferenceDoesntExist" />
        <xs:enumeration value="otherFailure" />
    </xs:restriction>
</xs:simpleType>

<!-- ADD USER MEDIA TYPE -->
<xs:complexType name="add-endpoint-media-type">
    <xs:sequence>
        <xs:element name="mediaKeys" type="tns:media-keys-type"/>
        <xs:element ref="ci:media" />
        <xs:any namespace="##other" processContents="lax" minOccurs="0"
maxOccurs="unbounded" />
    </xs:sequence>
    <xs:attribute ref="mscp:mcuUri" use="optional"/>
    <xs:anyAttribute namespace="##other" processContents="lax" />
</xs:complexType>

<!-- ADD USER MEDIA REASON CODE TYPE -->
<xs:simpleType name="add-endpoint-media-reason-code-type-ex">
    <xs:union memberTypes="tns:add-endpoint-media-reason-code-type xs:string"/>
</xs:simpleType>

<xs:simpleType name="add-endpoint-media-reason-code-type">
    <xs:restriction base="xs:string">
        <xs:enumeration value="conferenceDoesntExist" />
    </xs:restriction>
</xs:simpleType>

```

```

        <xs:enumeration value="userDoesntExist" />
        <xs:enumeration value="endpointDoesntExist" />
        <xs:enumeration value="mediaExistsAlready" />
        <xs:enumeration value="otherFailure" />
    </xs:restriction>
</xs:simpleType>

<!-- ADD USER MEDIA RESPONSE TYPE -->
<xs:complexType name="add-endpoint-media-response-type">
    <xs:sequence>
        <xs:element ref="mscp:diagnostics-info" minOccurs="0"/>
        <xs:element name="endpointKeys" type="tns:endpoint-keys-type" minOccurs="0"/>
        <xs:element ref="ci:media" minOccurs="0" />
        <xs:sequence minOccurs="0">
            <xs:element ref="cis:separator" />
            <xs:any namespace="##other" processContents="lax" maxOccurs="unbounded" />
        </xs:sequence>
    </xs:sequence>
    <xs:attribute name="reason" type="tns:add-endpoint-media-reason-code-type-ex"
use="optional"/>
    <xs:attribute ref="mscp:mcuUri" use="optional"/>
    <xs:anyAttribute namespace="##other" processContents="lax" />
</xs:complexType>

<!-- DELETE ENDPOINT MEDIA TYPE -->
<xs:complexType name="delete-endpoint-media-type">
    <xs:sequence>
        <xs:element name="mediaKeys" type="tns:media-keys-type"/>
        <xs:any namespace="##other" processContents="lax" minOccurs="0"
maxOccurs="unbounded" />
    </xs:sequence>
    <xs:attribute ref="mscp:mcuUri" use="optional"/>
    <xs:anyAttribute namespace="##other" processContents="lax" />
</xs:complexType>

<!-- DELETE ENDPOINT MEDIA RESPONSE TYPE -->
<xs:complexType name="delete-endpoint-media-response-type">
    <xs:sequence>
        <xs:element ref="mscp:diagnostics-info" minOccurs="0"/>
        <xs:element name="endpointKeys" type="tns:endpoint-keys-type" minOccurs="0" />
        <xs:element ref="ci:media" minOccurs="0" />
        <xs:sequence minOccurs="0">
            <xs:element ref="cis:separator" />
            <xs:any namespace="##other" processContents="lax" maxOccurs="unbounded" />
        </xs:sequence>
    </xs:sequence>
    <xs:attribute name="reason" type="tns:delete-endpoint-media-reason-code-type-ex"
use="optional"/>
    <xs:attribute ref="mscp:mcuUri" use="optional" />
    <xs:anyAttribute namespace="##other" processContents="lax"/>
</xs:complexType>

<!-- DELETE MEDIA REASON CODE TYPE -->
<xs:simpleType name="delete-endpoint-media-reason-code-type-ex">
    <xs:union memberTypes="tns:delete-endpoint-media-reason-code-type xs:string"/>
</xs:simpleType>

<xs:simpleType name="delete-endpoint-media-reason-code-type">
    <xs:restriction base="xs:string">
        <xs:enumeration value="conferenceDoesntExist"/>
        <xs:enumeration value="userDoesntExist"/>
        <xs:enumeration value="endpointDoesntExist"/>
        <xs:enumeration value="mediaDoesntExist"/>
        <xs:enumeration value="otherFailure"/>
    </xs:restriction>
</xs:simpleType>

<!-- SERVER LIST TYPE -->
<xs:complexType name="server-list-type">

```

```

    <xs:sequence>
      <xs:element name="entry" type="tns:server-description-type" minOccurs="0"
maxOccurs="unbounded"/>
      <xs:any namespace="##other" processContents="lax" minOccurs="0"
maxOccurs="unbounded" />
    </xs:sequence>
    <xs:attribute name="version" type="xs:unsignedInt" use="optional" />
    <xs:anyAttribute namespace="##other" processContents="lax" />
  </xs:complexType>

<!-- SERVER DESCRIPTION TYPE -->
<xs:complexType name="server-description-type">
  <xs:sequence>
    <xs:element name="status" type="tns:server-status-type" minOccurs="0" />
    <xs:element name="modality" type="xs:string" />
    <xs:element name="vendor" type="xs:string" minOccurs="0"/>
    <xs:element ref="mscp:drainStatus" minOccurs="0" />
    <xs:sequence minOccurs="0">
      <xs:element ref="cis:separator" />
      <xs:any namespace="##other" processContents="lax" maxOccurs="unbounded" />
    </xs:sequence>
  </xs:sequence>
  <xs:attribute name="entity" type="xs:anyURI" use="required"/>
  <xs:anyAttribute namespace="##other" processContents="lax" />
</xs:complexType>

<!-- SERVER STATUS TYPE -->
<xs:simpleType name="server-status-type">
  <xs:restriction base="xs:string">
    <xs:enumeration value="normal" />
    <xs:enumeration value="loaded" />
    <xs:enumeration value="full" />
    <xs:enumeration value="unavailable" />
  </xs:restriction>
</xs:simpleType>

<!-- SERVER TYPE TYPE -->
<xs:simpleType name="server-type-type">
  <xs:restriction base="xs:string">
    <xs:enumeration value="meeting-mcu" />
    <xs:enumeration value="audio-video-mcu" />
    <xs:enumeration value="phone-conf-mcu" />
    <xs:enumeration value="chat-mcu" />
  </xs:restriction>
</xs:simpleType>

<!-- ADD SIDEBAR TYPE -->
<xs:complexType name="add-sidebar-type">
  <xs:sequence>
    <xs:element name="conferenceKeys" type="tns:conference-keys-type" />
    <!-- Sidebar information -->
    <xs:element name="sidebar-info" type="ci:conference-type" />
    <xs:any namespace="##other" processContents="lax" minOccurs="0"
maxOccurs="unbounded" />
  </xs:sequence>
  <xs:anyAttribute namespace="##other" processContents="lax" />
</xs:complexType>

<!-- ADD SIDEBAR RESPONSE TYPE -->
<xs:complexType name="add-sidebar-response-type">
  <xs:sequence>
    <xs:element ref="mscp:diagnostics-info" minOccurs="0"/>
    <xs:element name="sidebarKeys" type="tns:sidebar-keys-type" minOccurs="0" />
    <xs:sequence minOccurs="0">
      <xs:element ref="cis:separator" />
      <xs:any namespace="##other" processContents="lax" maxOccurs="unbounded" />
    </xs:sequence>
  </xs:sequence>
</xs:complexType>

```

```

    <xs:attribute name="reason" type="tns:add-sidebar-reason-code-type-ex" use="optional"
/>
</xs:complexType>
</xs:complexType>

<!-- ADD SIDEBAR REASON CODE TYPE -->
<xs:simpleType name="add-sidebar-reason-code-type-ex">
  <xs:union memberTypes="tns:add-sidebar-reason-code-type xs:string"/>
</xs:simpleType>

<xs:simpleType name="add-sidebar-reason-code-type">
  <xs:restriction base="xs:string">
    <xs:enumeration value="conferenceDoesntExist" />
    <xs:enumeration value="sidebarExistsAlready" />
    <xs:enumeration value="otherFailure" />
  </xs:restriction>
</xs:simpleType>

<!-- DELETE SIDEBAR TYPE -->
<xs:complexType name="delete-sidebar-type">
  <xs:sequence>
    <xs:element name="sidebarKeys" type="tns:sidebar-keys-type" />
    <xs:any namespace="##other" processContents="lax" minOccurs="0"
maxOccurs="unbounded" />
  </xs:sequence>
  <xs:anyAttribute namespace="##other" processContents="lax" />
</xs:complexType>

<!-- DELETE SIDEBAR RESPONSE TYPE -->
<xs:complexType name="delete-sidebar-response-type">
  <xs:sequence>
    <xs:element ref="mscp:diagnostics-info" minOccurs="0"/>
    <xs:element name="sidebarKeys" type="tns:sidebar-keys-type" minOccurs="0" />
    <xs:sequence minOccurs="0">
      <xs:element ref="cis:separator" />
      <xs:any namespace="##other" processContents="lax" maxOccurs="unbounded" />
    </xs:sequence>
  </xs:sequence>
  <xs:attribute name="reason" type="tns:delete-sidebar-reason-code-type-ex"
use="optional" />
  <xs:anyAttribute namespace="##other" processContents="lax" />
</xs:complexType>

<!-- DELETE SIDEBAR REASON CODE TYPE -->
<xs:simpleType name="delete-sidebar-reason-code-type-ex">
  <xs:union memberTypes="tns:delete-sidebar-reason-code-type xs:string"/>
</xs:simpleType>

<xs:simpleType name="delete-sidebar-reason-code-type">
  <xs:restriction base="xs:string">
    <xs:enumeration value="conferenceDoesntExist" />
    <xs:enumeration value="sidebarDoesntExist" />
    <xs:enumeration value="otherFailure" />
  </xs:restriction>
</xs:simpleType>

<!-- MOVE USER TO SIDEBAR TYPE -->
<xs:complexType name="move-user-to-sidebar-type">
  <xs:sequence>
    <xs:element name="userKeys" type="tns:user-keys-type" />
    <xs:any namespace="##other" processContents="lax" minOccurs="0"
maxOccurs="unbounded" />
  </xs:sequence>
  <xs:attribute name="sourceSidebarEntity" type="xs:anyURI" use="optional" />
  <xs:attribute name="targetSidebarEntity" type="xs:anyURI" use="optional" />
  <xs:anyAttribute namespace="##other" processContents="lax" />
</xs:complexType>

<!-- MOVE USER TO SIDEBAR RESPONSE TYPE -->

```

```

<xs:complexType name="move-user-to-sidebar-response-type">
  <xs:sequence>
    <xs:element ref="mscp:diagnostics-info" minOccurs="0"/>
    <xs:element name="userKeys" type="tns:user-keys-type" minOccurs="0" />
    <xs:sequence minOccurs="0">
      <xs:element ref="cis:separator" />
      <xs:any namespace="##other" processContents="lax" maxOccurs="unbounded" />
    </xs:sequence>
  </xs:sequence>
  <xs:attribute name="reason" type="tns:move-user-to-sidebar-reason-code-type-ex"
use="optional" />
  <xs:attribute name="sourceSidebarEntity" type="xs:anyURI" use="optional" />
  <xs:attribute name="targetSidebarEntity" type="xs:anyURI" use="optional" />
  <xs:anyAttribute namespace="##other" processContents="lax" />
</xs:complexType>

<!-- MOVE USER TO SIDEBAR REASON CODE TYPE -->
<xs:simpleType name="move-user-to-sidebar-reason-code-type-ex">
  <xs:union memberTypes="tns:move-user-to-sidebar-reason-code-type xs:string"/>
</xs:simpleType>

<xs:simpleType name="move-user-to-sidebar-reason-code-type">
  <xs:restriction base="xs:string">
    <xs:enumeration value="conferenceDoesntExist" />
    <xs:enumeration value="userDoesntExist" />
    <xs:enumeration value="sourceSidebarDoesntExist" />
    <xs:enumeration value="userNotInSourceSidebar" />
    <xs:enumeration value="targetSidebarDoesntExist" />
    <xs:enumeration value="otherFailure" />
  </xs:restriction>
</xs:simpleType>

<!-- PLAY RECORDED NAME ELEMENT -->
<xs:element name="playRecordedName" type="tns:play-recorded-name-type"/>

<!-- PLAY RECORDED NAME TYPE -->
<xs:complexType name="play-recorded-name-type">
  <xs:sequence>
    <xs:element name="endpointKeys" type="tns:endpoint-keys-type" />
    <xs:any namespace="##other" processContents="lax" minOccurs="0"
maxOccurs="unbounded" />
  </xs:sequence>
  <xs:attribute ref="mscp:mcuUri" use="optional" />
</xs:complexType>

<!-- PLAY RECORDED NAME RESPONSE TYPE -->
<xs:complexType name="play-recorded-name-response-type">
  <xs:sequence>
    <xs:element ref="mscp:diagnostics-info" minOccurs="0"/>
    <xs:element name="endpointKeys" type="tns:endpoint-keys-type" />
    <xs:sequence minOccurs="0">
      <xs:element ref="cis:separator" />
      <xs:any namespace="##other" processContents="lax" maxOccurs="unbounded" />
    </xs:sequence>
  </xs:sequence>
  <xs:attribute name="reason" type="tns:play-recorded-name-reason-code-type-ex"
use="optional"/>
  <xs:attribute ref="mscp:mcuUri" use="optional" />
</xs:complexType>

<!-- PLAY RECORDED NAME REASON CODE TYPE -->
<xs:simpleType name="play-recorded-name-reason-code-type-ex">
  <xs:union memberTypes="tns:play-recorded-name-reason-code-type xs:string"/>
</xs:simpleType>

<xs:simpleType name="play-recorded-name-reason-code-type">
  <xs:restriction base="xs:string">
    <xs:enumeration value="conferenceDoesntExist" />
    <xs:enumeration value="userDoesntExist" />
  </xs:restriction>
</xs:simpleType>

```

```

        <xs:enumeration value="endpointDoesntExist" />
        <xs:enumeration value="otherFailure" />
    </xs:restriction>
</xs:simpleType>

<!-- START RECORDING TYPE -->
<xs:complexType name="start-recording-type">
    <xs:sequence>
        <xs:element name="recordingKeys" type="tns:recording-keys-type" />
        <xs:element name="paused" type="xs:boolean" minOccurs="0" />
        <xs:element ref="msci:recording-entities" />
        <xs:any namespace="##other" processContents="lax" minOccurs="0"
maxOccurs="unbounded" />
    </xs:sequence>
    <xs:anyAttribute namespace="##other" processContents="lax" />
</xs:complexType>

<!-- START RECORDING RESPONSE TYPE -->
<xs:complexType name="start-recording-response-type">
    <xs:sequence>
        <xs:element ref="mscp:diagnostics-info" minOccurs="0"/>
        <xs:element name="recordingKeys" type="tns:recording-keys-type" minOccurs="0" />
        <xs:element name="paused" type="xs:boolean" minOccurs="0" />
        <xs:element ref="msci:recording-entities" minOccurs="0" />
        <xs:element ref="msci:error" minOccurs="0" />
        <xs:sequence minOccurs="0">
            <xs:element ref="cis:separator" />
            <xs:any namespace="##other" processContents="lax" maxOccurs="unbounded" />
        </xs:sequence>
    </xs:sequence>
    <xs:attribute name="reason" type="tns:start-recording-reason-code-type-ex"
use="optional" />
    <xs:anyAttribute namespace="##other" processContents="lax" />
</xs:complexType>

<!-- START RECORDING REASON CODE TYPE -->
<xs:simpleType name="start-recording-reason-code-type-ex">
    <xs:union memberTypes="tns:start-recording-reason-code-type xs:string"/>
</xs:simpleType>

<xs:simpleType name="start-recording-reason-code-type">
    <xs:restriction base="xs:string">
        <xs:enumeration value="conferenceDoesntExist"/>
        <xs:enumeration value="recordingExistsAlready"/>
        <xs:enumeration value="anotherRecordingInProgress"/>
        <xs:enumeration value="unknownRecordedMediaType"/>
        <xs:enumeration value="otherFailure"/>
    </xs:restriction>
</xs:simpleType>

<!-- STOP RECORDING TYPE -->
<xs:complexType name="stop-recording-type">
    <xs:sequence>
        <xs:element name="recordingKeys" type="tns:recording-keys-type" />
        <xs:element name="publish" type="xs:boolean" />
        <xs:any namespace="##other" processContents="lax" minOccurs="0"
maxOccurs="unbounded" />
    </xs:sequence>
    <xs:anyAttribute namespace="##other" processContents="lax" />
</xs:complexType>

<!-- STOP RECORDING RESPONSE TYPE -->
<xs:complexType name="stop-recording-response-type">
    <xs:sequence>
        <xs:element ref="mscp:diagnostics-info" minOccurs="0"/>
        <xs:element name="recordingKeys" type="tns:recording-keys-type" minOccurs="0" />
        <xs:element name="publish" type="xs:boolean" minOccurs="0" />
        <xs:sequence minOccurs="0">
            <xs:element ref="cis:separator" />

```



```

        <xs:any namespace="##other" processContents="lax" maxOccurs="unbounded" />
    </xs:sequence>
</xs:sequence>
    <xs:attribute name="reason" type="tns:stop-recording-reason-code-type-ex"
use="optional" />
    <xs:anyAttribute namespace="##other" processContents="lax" />
</xs:complexType>

<!-- STOP RECORDING REASON CODE TYPE -->
<xs:simpleType name="stop-recording-reason-code-type-ex">
    <xs:union memberTypes="tns:stop-recording-reason-code-type xs:string"/>
</xs:simpleType>

<xs:simpleType name="stop-recording-reason-code-type">
    <xs:restriction base="xs:string">
        <xs:enumeration value="conferenceDoesntExist"/>
        <xs:enumeration value="recordingDoesntExist"/>
        <xs:enumeration value="otherFailure"/>
    </xs:restriction>
</xs:simpleType>

<!-- PAUSE RECORDING TYPE -->
<xs:complexType name="pause-recording-type">
    <xs:sequence>
        <xs:element name="recordingKeys" type="tns:recording-keys-type" />
        <xs:any namespace="##other" processContents="lax" minOccurs="0"
maxOccurs="unbounded" />
    </xs:sequence>
    <xs:anyAttribute namespace="##other" processContents="lax" />
</xs:complexType>

<!-- PAUSE RECORDING RESPONSE TYPE -->
<xs:complexType name="pause-recording-response-type">
    <xs:sequence>
        <xs:element ref="mscp:diagnostics-info" minOccurs="0"/>
        <xs:element name="recordingKeys" type="tns:recording-keys-type" minOccurs="0" />
        <xs:sequence minOccurs="0">
            <xs:element ref="cis:separator" />
            <xs:any namespace="##other" processContents="lax" maxOccurs="unbounded" />
        </xs:sequence>
    </xs:sequence>
    <xs:attribute name="reason" type="tns:pause-recording-reason-code-type-ex"
use="optional" />
    <xs:anyAttribute namespace="##other" processContents="lax" />
</xs:complexType>

<!-- PAUSE RECORDING REASON CODE TYPE -->
<xs:simpleType name="pause-recording-reason-code-type-ex">
    <xs:union memberTypes="tns:pause-recording-reason-code-type xs:string"/>
</xs:simpleType>

<xs:simpleType name="pause-recording-reason-code-type">
    <xs:restriction base="xs:string">
        <xs:enumeration value="conferenceDoesntExist"/>
        <xs:enumeration value="recordingDoesntExist"/>
        <xs:enumeration value="recordingAlreadyPaused"/>
        <xs:enumeration value="otherFailure"/>
    </xs:restriction>
</xs:simpleType>

<!-- RESUME RECORDING TYPE -->
<xs:complexType name="resume-recording-type">
    <xs:sequence>
        <xs:element name="recordingKeys" type="tns:recording-keys-type" />
        <xs:any namespace="##other" processContents="lax" minOccurs="0"
maxOccurs="unbounded" />
    </xs:sequence>
    <xs:anyAttribute namespace="##other" processContents="lax" />
</xs:complexType>

```

```

<!-- RESUME RECORDING RESPONSE TYPE -->
<xs:complexType name="resume-recording-response-type">
  <xs:sequence>
    <xs:element ref="mscp:diagnostics-info" minOccurs="0"/>
    <xs:element name="recordingKeys" type="tns:recording-keys-type" minOccurs="0" />
    <xs:sequence minOccurs="0">
      <xs:element ref="cis:separator" />
      <xs:any namespace="##other" processContents="lax" maxOccurs="unbounded" />
    </xs:sequence>
  </xs:sequence>
  <xs:attribute name="reason" type="tns:resume-recording-reason-code-type-ex"
use="optional" />
  <xs:anyAttribute namespace="##other" processContents="lax" />
</xs:complexType>

<!-- RESUME RECORDING REASON CODE TYPE -->
<xs:simpleType name="resume-recording-reason-code-type-ex">
  <xs:union memberTypes="tns:resume-recording-reason-code-type xs:string"/>
</xs:simpleType>

<xs:simpleType name="resume-recording-reason-code-type">
  <xs:restriction base="xs:string">
    <xs:enumeration value="conferenceDoesntExist"/>
    <xs:enumeration value="recordingDoesntExist"/>
    <xs:enumeration value="recordingNotPaused"/>
    <xs:enumeration value="otherFailure"/>
  </xs:restriction>
</xs:simpleType>

<!-- GET CONFERENCE KEY HASH REQUEST TYPE -->
<xs:complexType name="get-conference-key-hash-type" ms:notPublished="true">
  <xs:sequence>
    <xs:element name="conferenceKeys" type="tns:conference-keys-type"/>
    <xs:element ref="ci:user"/>
    <xs:element ref="msls:keyHashAlgorithm" minOccurs="0"/>
    <xs:sequence minOccurs="0">
      <xs:element ref="cis:separator"/>
      <xs:any namespace="##other" processContents="lax" maxOccurs="unbounded"/>
    </xs:sequence>
  </xs:sequence>
  <xs:attribute ref="msls:is-proxied" use="optional" default="false" />
  <xs:anyAttribute namespace="##other" processContents="lax"/>
</xs:complexType>

<!-- GET CONFERENCE KEY HASH RESPONSE TYPE -->
<xs:complexType name="get-conference-key-hash-response-type" ms:notPublished="true">
  <xs:sequence>
    <xs:element ref="mscp:diagnostics-info" minOccurs="0"/>
    <xs:element name="conferenceKeys" type="tns:conference-keys-type" minOccurs="0"/>
    <xs:element ref="msls:conferenceKeyHash" minOccurs="0"/>
    <xs:sequence minOccurs="0">
      <xs:element ref="cis:separator"/>
      <xs:any namespace="##other" processContents="lax" maxOccurs="unbounded"/>
    </xs:sequence>
  </xs:sequence>
  <xs:attribute name="reason" type="tns:get-conference-key-hash-reason-code-type-ex"
use="optional"/>
  <xs:anyAttribute namespace="##other" processContents="lax"/>
</xs:complexType>

<!-- GET CONFERENCE KEY HASH REASON CODE TYPE -->
<xs:simpleType name="get-conference-key-hash-reason-code-type-ex"
ms:notPublished="true">
  <xs:union memberTypes="tns:get-conference-key-hash-reason-code-type xs:string"/>
</xs:simpleType>

<xs:simpleType name="get-conference-key-hash-reason-code-type" ms:notPublished="true">
  <xs:restriction base="xs:string">

```

```

        <xs:enumeration value="conferenceDoesntExist"/>
        <xs:enumeration value="anonymousUsersNotAllowed"/>
        <xs:enumeration value="anonymousSaAlreadyEstablished"/>
        <xs:enumeration value="otherFailure"/>
    </xs:restriction>
</xs:simpleType>

<!-- GET CONFERENCING CAPABILITIES TYPE -->
<xs:complexType name="get-conferencing-capabilities-type">
    <xs:sequence>
        <xs:any namespace="##other" processContents="lax" minOccurs="0"
maxOccurs="unbounded"/>
    </xs:sequence>
    <xs:attribute name="server-mode" type="xs:unsignedInt" use="optional" default="14"/>
    <xs:anyAttribute namespace="##other" processContents="lax"/>
</xs:complexType>

<xs:complexType name="pstn-bridging-capabilities-type">
    <xs:sequence>
        <xs:element name="enabled" type="xs:boolean"/>
        <xs:element name="access-numbers" type="msci:pstn-access-numbers-type"
minOccurs="0"/>
        <xs:sequence minOccurs="0">
            <xs:element ref="cis:separator" />
            <xs:any namespace="##other" processContents="lax" maxOccurs="unbounded" />
        </xs:sequence>
    </xs:sequence>
    <xs:anyAttribute namespace="##other" processContents="lax"/>
</xs:complexType>

<!-- GET CONFERENCING CAPABILITIES RESPONSE TYPE -->
<xs:complexType name="get-conferencing-capabilities-response-type">
    <xs:sequence>
        <xs:element ref="mscp:diagnostics-info" minOccurs="0"/>
        <xs:element name="mcu-types" type="tns:mcu-types-type"/>
        <xs:element name="pstn-bridging" type="tns:pstn-bridging-capabilities-type"/>
        <xs:element name="conference-key-optional" type="xs:boolean" default="false"
minOccurs="0"/>
        <xs:element name="anonymous-scheduling" type="xs:boolean" minOccurs="0"/>
        <xs:element name="default-admission-policy" type="msci:admission-policy-type"
minOccurs="0"/>
        <xs:sequence minOccurs="0">
            <xs:element ref="cis:separator" />
            <xs:element ref="mscp:schedule-locked" minOccurs="0" />
            <xs:element ref="msci:autopromote-allowed" minOccurs="0"/>
            <xs:element ref="mscp:default-autopromote" minOccurs="0"/>
            <xs:element ref="msci:pstn-lobby-bypass-allowed" minOccurs="0"/>
            <xs:element ref="mscp:static-meeting-limit" minOccurs="0"/>
            <xs:element ref="mscp:default-meeting-static" minOccurs="0"/>
            <xs:element ref="msci:recording-allowed" minOccurs="0"/>
            <xs:element ref="msci:externaluser-recording-allowed" minOccurs="0"/>
            <xs:element ref="mscp:schedule-key-optional" minOccurs="0"/>
            <xs:element ref="msci:default-entry-exit-announcements" minOccurs="0"/>
            <xs:sequence minOccurs="0">
                <xs:element ref="cis:separator"/>
                <xs:element ref="msci:custom-invite" minOccurs="0"/>
                <xs:element ref="msci:endorse-allowed" minOccurs="0"/>
                <xs:element ref="msci:main-video-mute-allowed" minOccurs="0"/>
                <xs:element ref="msci:pano-video-mute-allowed" minOccurs="0"/>
            </xs:sequence>
            <xs:sequence minOccurs="0">
                <xs:element ref="cis:separator"/>
                <xs:any namespace="##other" processContents="lax" maxOccurs="unbounded"/>
            </xs:sequence>
        </xs:sequence>
    </xs:sequence>
    <xs:attribute name="reason" type="tns:get-conferencing-capabilities-reason-code-type-
ex" use="optional"/>

```

```

    <xs:attribute name="capability-version" type="xs:nonNegativeInteger" default="0"
use="optional"/>
    <xs:anyAttribute namespace="##other" processContents="lax"/>
  </xs:complexType>

  <!-- GET CONFERENCING CAPABILITIES REASON CODE TYPE -->
  <xs:simpleType name="get-conferencing-capabilities-reason-code-type-ex">
    <xs:union memberTypes="tns:get-conferencing-capabilities-reason-code-type
xs:string"/>
  </xs:simpleType>

  <xs:simpleType name="get-conferencing-capabilities-reason-code-type">
    <xs:restriction base="xs:string">
      <xs:enumeration value="otherFailure"/>
    </xs:restriction>
  </xs:simpleType>

  <!-- MEETING-ID-MAPPING -->
  <xs:complexType name="meeting-id-mapping-type" >
    <xs:sequence>
      <xs:element ref="ci:user"/>
      <xs:element ref="msci:conference-id"/>
      <xs:element name="authority-id" type="xs:nonNegativeInteger"/>
      <xs:element name="local-id" type="xs:nonNegativeInteger"/>
      <xs:any namespace="##other" processContents="lax" minOccurs="0"
maxOccurs="unbounded" />
    </xs:sequence>
    <xs:anyAttribute namespace="##other" processContents="lax"/>
  </xs:complexType>

  <!-- DELETE MEETING ID TYPE -->
  <xs:complexType name="delete-meeting-id-type">
    <xs:sequence>
      <xs:element name="mapping" type="tns:meeting-id-mapping-type"
maxOccurs="unbounded"/>
      <xs:any namespace="##other" processContents="lax" minOccurs="0"
maxOccurs="unbounded" />
    </xs:sequence>
    <xs:anyAttribute namespace="##other" processContents="lax"/>
  </xs:complexType>

  <!-- DELETE MEETING ID RESPONSE TYPE -->
  <xs:complexType name="delete-meeting-id-response-type">
    <xs:sequence>
      <xs:element ref="mscp:diagnostics-info" minOccurs="0"/>
      <xs:sequence minOccurs="0">
        <xs:element ref="cis:separator" />
        <xs:any namespace="##other" processContents="lax" maxOccurs="unbounded" />
      </xs:sequence>
    </xs:sequence>
    <xs:attribute name="reason" type="tns:delete-meeting-id-reason-code-type-ex"
use="optional"/>
    <xs:anyAttribute namespace="##other" processContents="lax"/>
  </xs:complexType>

  <!-- DELETE MEETING ID REASON CODE TYPE -->
  <xs:simpleType name="delete-meeting-id-reason-code-type-ex">
    <xs:union memberTypes="tns:delete-meeting-id-reason-code-type xs:string"/>
  </xs:simpleType>

  <xs:simpleType name="delete-meeting-id-reason-code-type">
    <xs:restriction base="xs:string">
      <xs:enumeration value="badRequest"/>
      <xs:enumeration value="otherFailure"/>
    </xs:restriction>
  </xs:simpleType>

  <!-- QUERY MEETING ID TYPE -->
  <xs:complexType name="query-meeting-id-type">

```

```

    <xs:sequence>
      <xs:element name="mapping" type="tns:meeting-id-mapping-type"
maxOccurs="unbounded"/>
      <xs:any namespace="##other" processContents="lax" minOccurs="0"
maxOccurs="unbounded" />
    </xs:sequence>
  <xs:anyAttribute namespace="##other" processContents="lax"/>
</xs:complexType>

<!-- QUERY MEETING ID RESPONSE TYPE -->
<xs:complexType name="query-meeting-id-response-type">
  <xs:sequence>
    <xs:element ref="mscp:diagnostics-info" minOccurs="0"/>
    <xs:element name="mapping" type="tns:meeting-id-mapping-type" minOccurs="0"
maxOccurs="unbounded"/>
    <xs:sequence minOccurs="0">
      <xs:element ref="cis:separator" />
      <xs:any namespace="##other" processContents="lax" maxOccurs="unbounded" />
    </xs:sequence>
  </xs:sequence>
  <xs:attribute name="reason" type="tns:query-meeting-id-reason-code-type-ex"
use="optional"/>
  <xs:anyAttribute namespace="##other" processContents="lax"/>
</xs:complexType>

<!-- QUERY MEETING ID REASON CODE TYPE -->
<xs:simpleType name="query-meeting-id-reason-code-type-ex">
  <xs:union memberTypes="tns:query-meeting-id-reason-code-type xs:string"/>
</xs:simpleType>

<xs:simpleType name="query-meeting-id-reason-code-type">
  <xs:restriction base="xs:string">
    <xs:enumeration value="badRequest"/>
    <xs:enumeration value="otherFailure"/>
  </xs:restriction>
</xs:simpleType>

<!-- RESOLVE CONFERENCE TYPE -->
<xs:complexType name="resolve-conference-type">
  <xs:sequence>
    <xs:element name="pstn-meeting-id" type="msci:pstn-meeting-id-type" minOccurs="0"/>
    <xs:sequence minOccurs="0">
      <xs:element ref="cis:separator" />
      <xs:any namespace="##other" processContents="lax" maxOccurs="unbounded" />
    </xs:sequence>
  </xs:sequence>
</xs:complexType>

<!-- RESOLVE CONFERENCE RESPONSE TYPE -->
<xs:complexType name="resolve-conference-response-type">
  <xs:sequence>
    <xs:element ref="mscp:diagnostics-info" minOccurs="0"/>
    <xs:element ref="ci:user" minOccurs="0"/>
    <xs:element ref="msci:conference-id" minOccurs="0"/>
    <xs:sequence minOccurs="0">
      <xs:element ref="cis:separator" />
      <xs:any namespace="##other" processContents="lax" maxOccurs="unbounded" />
    </xs:sequence>
  </xs:sequence>
  <xs:attribute name="entity" type="xs:anyURI" use="optional"/>
  <xs:attribute name="reason" type="tns:resolve-conference-reason-code-type-ex"
use="optional"/>
  <xs:anyAttribute namespace="##other" processContents="lax"/>
</xs:complexType>

<!-- RESOLVE CONFERENCE REASON CODE TYPE -->
<xs:simpleType name="resolve-conference-reason-code-type-ex">
  <xs:union memberTypes="tns:resolve-conference-reason-code-type xs:string"/>
</xs:simpleType>

```

```

<xs:simpleType name="resolve-conference-reason-code-type">
  <xs:restriction base="xs:string">
    <xs:enumeration value="unauthorized" />
    <xs:enumeration value="pstnMeetingIdNotFound"/>
    <xs:enumeration value="otherFailure"/>
  </xs:restriction>
</xs:simpleType>

<xs:complexType name="modify-conference-announcements-type">
  <xs:sequence>
    <xs:element name="conferenceKeys" type="tns:conference-keys-type"/>
    <xs:element name="enabled" type="xs:boolean"/>
    <xs:any namespace="##other" processContents="lax" minOccurs="0"
maxOccurs="unbounded" />
  </xs:sequence>
  <xs:attribute ref="mscp:mcuUri" use="optional"/>
  <xs:anyAttribute namespace="##other" processContents="lax" />
</xs:complexType>

<xs:complexType name="modify-conference-announcements-response-type">
  <xs:sequence>
    <xs:element ref="mscp:diagnostics-info" minOccurs="0"/>
    <xs:element name="enabled" type="xs:boolean"/>
    <xs:sequence minOccurs="0">
      <xs:element ref="cis:separator" />
      <xs:any namespace="##other" processContents="lax" maxOccurs="unbounded" />
    </xs:sequence>
  </xs:sequence>
  <xs:attribute ref="mscp:mcuUri" use="optional"/>
  <xs:attribute name="reason" type="tns:modify-conference-announcements-reason-code-
type-ex" use="optional"/>
  <xs:anyAttribute namespace="##other" processContents="lax" />
</xs:complexType>

<xs:simpleType name="modify-conference-announcements-reason-code-type-ex">
  <xs:union memberTypes="tns:modify-conference-announcements-reason-code-type
xs:string"/>
</xs:simpleType>

<xs:simpleType name="modify-conference-announcements-reason-code-type">
  <xs:restriction base="xs:string">
    <xs:enumeration value="conferenceDoesntExist" />
    <xs:enumeration value="notSupported" />
    <xs:enumeration value="otherFailure" />
  </xs:restriction>
</xs:simpleType>

<!-- GET MEETING ID TYPE -->
<!--ms:notPublished="true"-->
<xs:complexType name="get-meeting-id-type" >
  <xs:sequence>
    <xs:element ref="ci:user"/>
    <xs:element ref="msci:conference-id"/>
    <xs:element name="authority-id" type="xs:nonNegativeInteger"/>
    <xs:any namespace="##other" processContents="lax" minOccurs="0"
maxOccurs="unbounded" />
  </xs:sequence>
  <xs:anyAttribute namespace="##other" processContents="lax"/>
</xs:complexType>

<!-- GET MEETING ID RESPONSE TYPE -->
<xs:complexType name="get-meeting-id-response-type" >
  <xs:sequence>
    <xs:element ref="mscp:diagnostics-info" minOccurs="0"/>
    <xs:element name="mapping" type="tns:meeting-id-mapping-type" minOccurs="0"
maxOccurs="unbounded"/>
    <xs:sequence minOccurs="0">
      <xs:element ref="cis:separator" />

```

```

        <xs:any namespace="##other" processContents="lax" maxOccurs="unbounded" />
    </xs:sequence>
</xs:sequence>
    <xs:attribute name="reason" type="tns:get-meeting-id-reason-code-type-ex"
use="optional"/>
    <xs:anyAttribute namespace="##other" processContents="lax"/>
</xs:complexType>

<!-- GET MEETING ID REASON CODE TYPE -->
<xs:simpleType name="get-meeting-id-reason-code-type-ex">
    <xs:union memberTypes="tns:get-meeting-id-reason-code-type xs:string"/>
</xs:simpleType>

<xs:simpleType name="get-meeting-id-reason-code-type">
    <xs:restriction base="xs:string">
        <xs:enumeration value="existsAlready" />
        <xs:enumeration value="authorityDisabled"/>
        <xs:enumeration value="authorityFull"/>
        <xs:enumeration value="otherFailure"/>
    </xs:restriction>
</xs:simpleType>

</xs:schema>

```

6.2.2 cccpextensions Namespace

This namespace is identified by the following URN:

<http://schemas.microsoft.com/rtc/2005/08/cccpextensions>

```

<?xml version="1.0" encoding="utf-8"?><xs:schema
targetNamespace="http://schemas.microsoft.com/rtc/2005/08/cccpextensions"
xmlns:tns="http://schemas.microsoft.com/rtc/2005/08/cccpextensions"
xmlns:xs="http://www.w3.org/2001/XMLSchema"
xmlns:ci="urn:ietf:params:xml:ns:conference-info"
xmlns:mhci="http://schemas.microsoft.com/rtc/2005/08/confinfoextensions"
elementFormDefault="qualified"
attributeFormDefault="unqualified"
>

<!--
    This import brings in the Conference Package definitions + MS extensions
-->
<xs:import namespace="urn:ietf:params:xml:ns:conference-info" schemaLocation="ms-
ci.xsd"/>

<!--
    This import brings in additional Conference Package extensions
-->
<xs:import namespace="http://schemas.microsoft.com/rtc/2005/08/confinfoextensions"
schemaLocation="ms-ci-ext.xsd"/>

<!--
    General INFO TYPE

    is used as a generic container to include opaque DATA MCU PSOM settings and
permissions

    NOTE: This element is now obsolete, use connection-info instead
-->
<xs:element name="info" type="tns:info-type"/>

<xs:complexType name="info-type">
    <xs:sequence>
        <xs:element name="contact" type="xs:anyURI" minOccurs="0"/>

```

```

        <xs:any namespace="##other" processContents="lax" minOccurs="0"
maxOccurs="unbounded"/>
    </xs:sequence>
    <xs:anyAttribute namespace="##other" processContents="lax"/>
</xs:complexType>

<!--
    DIAGNOSTICS INFO TYPE
-->
<xs:element name="diagnostics-info" type="tns:diagnostics-info-type"/>

<xs:complexType name="diagnostics-info-type" >
    <xs:sequence>
        <xs:element name="entry" type="tns:key-value-pair-type" minOccurs="0"
maxOccurs="unbounded"/>
        <xs:any namespace="##other" processContents="lax" minOccurs="0"
maxOccurs="unbounded"/>
    </xs:sequence>
</xs:complexType>

<!--
    General CONNECTION INFO TYPE
-->
<xs:element name="connection-info" type="tns:connection-info-type"/>

<xs:complexType name="connection-info-type">
    <xs:sequence>
        <xs:element name="entry" type="tns:key-value-pair-type" minOccurs="0"
maxOccurs="unbounded"/>
        <xs:any namespace="##other" processContents="lax" minOccurs="0"
maxOccurs="unbounded"/>
    </xs:sequence>
</xs:complexType>

<!--
    KEY VALUE PAIR TYPE
-->
<xs:complexType name="key-value-pair-type">
    <xs:sequence>
        <xs:element name="key" type="xs:string"/>
        <xs:element name="value" type="xs:string"/>
    </xs:sequence>
</xs:complexType>

<!--
    DELETE USER REASON ELEMENT
-->
<xs:element name="reason" type="tns:delete-user-reason-type"/>

<xs:simpleType name="delete-user-reason-type">
    <xs:restriction base="xs:string">
        <xs:enumeration value="joinDialogDisconnected"/>
    </xs:restriction>
</xs:simpleType>

<!--
    MCU ID ATTRIBUTE
-->
<xs:attribute name="mcuUri" type="tns:mcu-id-type"/>

<xs:simpleType name="mcu-id-type">
    <xs:restriction base="xs:anyURI">
    </xs:restriction>
</xs:simpleType>

<!--
    DRAINING STATUS ELEMENT

```



```

-->
<xs:element name="drainStatus" type="tns:draining-status-type"/>

<!--
  DRAINING STATUS TYPE
-->
<xs:simpleType name="draining-status-type">
  <xs:restriction base="xs:string">
    <xs:enumeration value="request"/>
    <xs:enumeration value="acknowledge"/>
  </xs:restriction>
</xs:simpleType>

<!--
  allow-session-replaces ATTRIBUTE
-->
<xs:attribute name="allow-session-replace" type="xs:boolean"/>

<!-- Schedule Locked element -->
<xs:element name="schedule-locked" type="xs:boolean"/>

<!--
  CONFERENCE INSTANCE ID
-->
<xs:attribute name="conferenceInstance" type="tns:conference-instance-type"/>

<xs:attribute name="telemetry-id" type="tns:conference-instance-type"/>

<xs:simpleType name="conference-instance-type">
  <xs:restriction base="xs:string">
    <xs:pattern value="[a-fA-F0-9]{8}-[a-fA-F0-9]{4}-[a-fA-F0-9]{4}-[a-fA-F0-9]{4}-[a-fA-F0-9]{12}"/>
  </xs:restriction>
</xs:simpleType>

<!-- Static meeting limit element: How many static meetings may the user have? -->
<xs:element name="static-meeting-limit" type="xs:nonNegativeInteger"/>

<!-- Should clients offer a public or a private meeting as the default experience for
a scheduled meeting? -->
<xs:element name="default-meeting-static" type="xs:boolean"/>

<!-- What should be the default value for automatic promotion to presenter in a
private meeting? -->
<xs:element name="default-autopromote" type="msci:autopromote-type"/>

<!-- Does an anonymous addConference request to Focus Factory need to include a
conference-key? -->
<xs:element name="schedule-key-optional" type="xs:boolean"/>
</xs:schema>

```

6.3 application/conference-info+xml Schema

6.3.1 conference-info Namespace

This namespace is identified by the following URN:

```
urn:ietf:params:xml:ns:conference-info
```

The schema for this section is based on [RFC4575](#), with extensions specified in namespaces, which are defined subsequently.

```

<?xml version="1.0" encoding="utf-8"?>
<xs:schema
targetNamespace="urn:ietf:params:xml:ns:conference-info"
xmlns:cis="urn:ietf:params:xml:ns:conference-info-separator"
xmlns:xs="http://www.w3.org/2001/XMLSchema"
xmlns="urn:ietf:params:xml:ns:conference-info"
xmlns:mhci="http://schemas.microsoft.com/rtc/2005/08/confinfoextensions"
xmlns:ms="urn:microsoft-cpp-xml-serializer"
elementFormDefault="qualified"
attributeFormDefault="unqualified">
  <!--
    This imports the standard separator
  -->
  <xs:import namespace="urn:ietf:params:xml:ns:conference-info-separator"
schemaLocation="ms-ci-separator.xsd"/>

  <!--
    This import brings in the MS Conference Package extensions
  -->
  <xs:import namespace="http://schemas.microsoft.com/rtc/2005/08/confinfoextensions"
schemaLocation="ms-ci-ext.xsd"/>

  <!--
    ELEMENTS and Attributes for CCCP definitions
  -->
  <xs:attribute name="state" type="state-type"/>
  <xs:element name="media" type="media-type"/>
  <xs:element name="endpoint" type="endpoint-type"/>
  <xs:element name="user-roles" type="user-roles-type"/>
  <xs:element name="user" type="user-type"/>
  <xs:element name="dialog-id" type="sip-dialog-id-type"/>

  <!--
    CONFERENCE ELEMENT
  -->
  <xs:element name="conference-info" type="conference-type"/>

  <!--
    CONFERENCE TYPE
  -->
  <xs:complexType name="conference-type">
    <xs:sequence>
      <xs:element name="conference-description" type="conference-description-type"
minOccurs="0"/>
      <xs:element name="host-info" type="host-type" minOccurs="0"/>
      <xs:element name="conference-state" type="conference-state-type"
minOccurs="0"/>
      <xs:element name="users" type="users-type" minOccurs="0"/>
      <xs:element name="sidebars-by-ref" type="uris-type" minOccurs="0"/>
      <xs:element name="sidebars-by-val" type="sidebars-by-val-type"
minOccurs="0"/>
      <xs:element ref="mhci:conference-media-states" minOccurs="0"/>
      <xs:element ref="mhci:conference-view" minOccurs="0"/>
      <xs:sequence minOccurs="0">
        <xs:element ref="cis:separator"/>
        <xs:element ref="mhci:trusted-entities" minOccurs="0"/>
        <xs:sequence minOccurs="0">
          <xs:element ref="cis:separator"/>
          <xs:any namespace="##other" processContents="lax"
maxOccurs="unbounded"/>
        </xs:sequence>
      </xs:sequence>
    </xs:sequence>
    <xs:attribute ref="mhci:conference-id"/>
    <xs:attribute name="entity" type="xs:anyURI" use="required"/>
    <xs:attribute name="state" type="state-type" use="optional" default="full"/>
    <xs:attribute name="version" type="xs:unsignedInt" use="optional"/>
    <xs:attribute name="static" type="xs:boolean" use="optional"/>
    <xs:attribute name="deactivation-secs" type="xs:int" use="optional"/>

```

```

    <xs:anyAttribute namespace="##other" processContents="lax"/>
</xs:complexType>

<!--
  STATE TYPE
-->
<xs:simpleType name="state-type">
  <xs:restriction base="xs:string">
    <xs:enumeration value="full"/>
    <xs:enumeration value="partial"/>
    <xs:enumeration value="deleted"/>
  </xs:restriction>
</xs:simpleType>

<!--
  CONFERENCE DESCRIPTION TYPE
-->

<xs:complexType name="conference-description-type">
  <xs:sequence>
    <xs:element name="display-text" type="xs:string" minOccurs="0"/>
    <xs:element name="subject" type="xs:string" minOccurs="0"/>
    <xs:element name="free-text" type="xs:string" minOccurs="0"/>
    <xs:element name="keywords" type="keywords-type" minOccurs="0"/>
    <xs:element name="conf-uris" type="uris-type" minOccurs="0"/>
    <xs:element name="service-uris" type="uris-type" minOccurs="0"/>
    <xs:element name="maximum-user-count" type="xs:unsignedInt" minOccurs="0"/>
    <xs:element name="available-media" type="conference-media-type" minOccurs="0"/>
    <xs:element ref="msci:disclaimer" minOccurs="0"/>
    <xs:element ref="msci:organizer" minOccurs="0"/>
    <xs:element ref="msci:conference-id" minOccurs="0"/>
    <xs:element ref="msci:conference-key" minOccurs="0"/>
    <xs:element ref="msci:last-update" minOccurs="0"/>
    <xs:element ref="msci:last-activate" minOccurs="0"/>
    <xs:element ref="msci:is-active" minOccurs="0"/>
    <xs:element ref="msci:expiry-time" minOccurs="0"/>
    <xs:element ref="msci:admission-policy" minOccurs="0"/>
    <xs:element ref="msci:organizer-roaming-data" minOccurs="0"/>
    <xs:element ref="msci:notification-data" minOccurs="0"/>
    <xs:element ref="msci:conference-mcu-policies" minOccurs="0"
maxOccurs="unbounded"/>
    <xs:sequence minOccurs="0">
      <xs:element ref="cis:separator"/>
      <xs:element ref="msci:pstn-access" minOccurs="0"/>
      <xs:sequence minOccurs="0">
        <xs:element ref="cis:separator"/>
        <xs:element ref="msci:lobby-capable" minOccurs="0"/>
        <xs:element ref="msci:anonymous-type-allowed" minOccurs="0"/>
        <xs:element ref="msci:join-url" minOccurs="0"/>
        <xs:element ref="msci:autopromote" minOccurs="0"/>
        <xs:element ref="msci:autopromote-allowed" minOccurs="0"/>
        <xs:element ref="msci:pstn-lobby-bypass" minOccurs="0"/>
        <xs:element ref="msci:pstn-lobby-bypass-allowed" minOccurs="0"/>
        <xs:element ref="msci:disclaimer-title" minOccurs="0"/>
        <xs:element ref="msci:recording-allowed" minOccurs="0"/>
        <xs:element ref="msci:externaluser-recording-allowed" minOccurs="0"/>
        <xs:element ref="msci:server-mode" minOccurs="0"/>
        <xs:element ref="msci:recording-notification" minOccurs="0"/>
      </xs:sequence>
      <xs:sequence minOccurs="0">
        <xs:element ref="cis:separator"/>
        <xs:element ref="msci:custom-invite" minOccurs="0"/>
        <xs:element ref="msci:anonymous-dialout-allowed" minOccurs="0"/>
        <xs:element ref="msci:endorse-allowed" minOccurs="0"/>
        <xs:element ref="msci:main-video-mute-allowed" minOccurs="0"/>
        <xs:element ref="msci:pano-video-mute-allowed" minOccurs="0"/>
        <xs:element ref="msci:is-large-meeting" minOccurs="0"/>
      </xs:sequence>
      <xs:element ref="cis:separator"/>
    </xs:sequence>
  </xs:sequence>

```

```

        <xs:element ref="msci:in-room-user-notification-supported"
minOccurs="0"/>
        <xs:sequence minOccurs="0">
            <xs:element ref="cis:separator"/>
            <xs:element ref="msci:nonenterprise-user-dialout-allowed"
minOccurs="0"/>
            <xs:sequence minOccurs="0">
                <xs:element ref="cis:separator"/>
                <xs:any namespace="##other" processContents="lax"
maxOccurs="unbounded"/>
            </xs:sequence>
        </xs:sequence>
    </xs:sequence>
</xs:sequence>
</xs:sequence>
</xs:sequence>
</xs:sequence>
<xs:anyAttribute namespace="##other" processContents="lax"/>
</xs:complexType>

<!--
    HOST TYPE
-->
<xs:complexType name="host-type">
    <xs:sequence>
        <xs:element name="display-text" type="xs:string" minOccurs="0"/>
        <xs:element name="web-page" type="xs:anyURI" minOccurs="0"/>
        <xs:element name="uris" type="uris-type" minOccurs="0"/>
        <xs:any namespace="##other" processContents="lax" minOccurs="0"
maxOccurs="unbounded"/>
    </xs:sequence>
    <xs:anyAttribute namespace="##other" processContents="lax"/>
</xs:complexType>

<!--
    CONFERENCE STATE TYPE
-->
<xs:complexType name="conference-state-type">
    <xs:sequence>
        <xs:element name="user-count" type="xs:unsignedInt" minOccurs="0"/>
        <xs:element name="active" type="xs:boolean" minOccurs="0"/>
        <xs:element name="locked" type="xs:boolean" minOccurs="0"/>
        <xs:any namespace="##other" processContents="lax" minOccurs="0"
maxOccurs="unbounded"/>
    </xs:sequence>
    <xs:anyAttribute namespace="##other" processContents="lax"/>
</xs:complexType>

<!--
    CONFERENCE MEDIA TYPE
-->
<xs:complexType name="conference-media-type">
    <xs:sequence>
        <xs:element name="entry" type="conference-medium-type" maxOccurs="unbounded"/>
    </xs:sequence>
    <xs:anyAttribute namespace="##other" processContents="lax"/>
</xs:complexType>

<!--
    CONFERENCE MEDIUM TYPE
-->
<xs:complexType name="conference-medium-type">
    <xs:sequence>
        <xs:element name="display-text" type="xs:string" minOccurs="0"/>
        <xs:element name="type" type="xs:string"/>
        <xs:element name="status" type="media-status-type" minOccurs="0"/>
        <xs:element ref="msci:modal-parameters" minOccurs="0"/>
        <xs:sequence minOccurs="0">

```

```

        <xs:element ref="cis:separator"/>
        <xs:any namespace="##other" processContents="lax" maxOccurs="unbounded"/>
    </xs:sequence>
</xs:sequence>
<xs:attribute name="label" type="xs:string" use="required"/>
<xs:anyAttribute namespace="##other" processContents="lax"/>
</xs:complexType>

<!--
    URIs TYPE
-->
<xs:complexType name="uris-type">
    <xs:sequence>
        <xs:element name="entry" type="uri-type" maxOccurs="unbounded"/>
    </xs:sequence>
    <xs:attribute name="state" type="state-type" use="optional" default="full"/>
    <xs:anyAttribute namespace="##other" processContents="lax"/>
</xs:complexType>

<!--
    URI TYPE
-->
<xs:complexType name="uri-type">
    <xs:sequence>
        <xs:element name="uri" type="xs:anyURI"/>
        <xs:element name="display-text" type="xs:string" minOccurs="0"/>
        <xs:element name="purpose" type="xs:string" minOccurs="0"/>
        <xs:element name="modified" type="execution-type" minOccurs="0"/>
        <xs:element ref="msci:hash-code" minOccurs="0"/>
        <xs:sequence minOccurs="0">
            <xs:element ref="cis:separator"/>
            <xs:element ref="msci:encrypted-uri" minOccurs="0"/>
            <xs:sequence minOccurs="0">
                <xs:element ref="cis:separator"/>
                <xs:any namespace="##other" processContents="lax" maxOccurs="unbounded"/>
            </xs:sequence>
        </xs:sequence>
    </xs:sequence>
    <xs:anyAttribute namespace="##other" processContents="lax"/>
</xs:complexType>

<!--
    KEYWORDS TYPE
-->
<xs:simpleType name="keywords-type">
    <xs:list itemType="xs:string"/>
</xs:simpleType>

<!--
    USERS TYPE
-->
<xs:complexType name="users-type">
    <xs:sequence>
        <xs:element name="user" type="user-type" minOccurs="0"
maxOccurs="unbounded"/>
        <xs:any namespace="##other" processContents="lax" minOccurs="0"
maxOccurs="unbounded"/>
    </xs:sequence>
    <xs:attribute name="state" type="state-type"
use="optional" default="full"/>
    <xs:attribute ref="msci:participant-count" use="optional"/>
    <xs:anyAttribute namespace="##other" processContents="lax"/>
</xs:complexType>

<!--
    USER TYPE
-->
<xs:complexType name="user-type">
    <xs:sequence>

```

```

    <xs:element name="display-text" type="xs:string" minOccurs="0"/>
    <xs:element name="associated-aors" type="uris-type" minOccurs="0"/>
    <xs:element name="roles" type="user-roles-type" minOccurs="0"/>
    <xs:element name="languages" type="user-languages-type" minOccurs="0"/>
    <xs:element name="cascaded-focus" type="xs:anyURI" minOccurs="0"/>
    <xs:element name="endpoint" type="endpoint-type" minOccurs="0"
maxOccurs="unbounded"/>
    <xs:element ref="msci:designated-presenter" minOccurs="0"/>
    <xs:sequence minOccurs="0">
      <xs:element ref="cis:separator"/>
      <xs:element ref="msci:trusted" minOccurs="0"/>
      <xs:sequence minOccurs="0">
        <xs:element ref="cis:separator"/>
        <xs:any namespace="##other" processContents="lax"
maxOccurs="unbounded"/>
      </xs:sequence>
    </xs:sequence>
  </xs:sequence>
  <xs:attribute name="entity" type="xs:anyURI"/>
  <xs:attribute ref="msci:smtp-address"/>
  <xs:attribute name="state" type="state-type"
use="optional" default="full"/>
  <xs:attribute ref="msci:endorser" use="optional"/>
  <xs:attribute ref="msci:endorser-display-name" use="optional"/>
  <xs:attribute ref="msci:device-type" use="optional"/>
  <xs:anyAttribute namespace="##other" processContents="lax"/>
</xs:complexType>

<!--
  USER ROLES TYPE
-->
<xs:complexType name="user-roles-type">
  <xs:sequence>
    <xs:element name="entry" type="xs:string" maxOccurs="unbounded"/>
  </xs:sequence>
  <xs:anyAttribute namespace="##other" processContents="lax"/>
</xs:complexType>

<!--
  USER LANGUAGES TYPE
-->
<xs:simpleType name="user-languages-type">
  <xs:list itemType="xs:language"/>
</xs:simpleType>

<!--
  ENDPOINT TYPE
-->
<xs:complexType name="endpoint-type">
  <xs:sequence>
    <xs:element name="display-text" type="xs:string" minOccurs="0"/>
    <xs:element name="referred" type="execution-type" minOccurs="0"/>
    <xs:element name="status" type="endpoint-status-type" minOccurs="0"/>
    <xs:element name="joining-method" type="joining-type" minOccurs="0"/>
    <xs:element name="joining-info" type="execution-type" minOccurs="0"/>
    <xs:element name="disconnection-method" type="disconnection-type"
minOccurs="0"/>
    <xs:element name="disconnection-info" type="execution-type" minOccurs="0"/>
    <xs:element name="media" type="media-type" minOccurs="0"
maxOccurs="unbounded"/>
    <xs:element name="call-info" type="call-type" minOccurs="0"/>
    <xs:element ref="msci:roles" minOccurs="0"/>
    <xs:element ref="msci:authMethod" minOccurs="0"/>
    <xs:element ref="msci:accessMethod" minOccurs="0"/>
    <xs:element ref="msci:clientInfo" minOccurs="0"/>
    <xs:element ref="msci:post-dial" minOccurs="0"/>
    <xs:element ref="msci:pstnRole" minOccurs="0"/>
    <xs:element ref="msci:pstnLeaderPasscode" minOccurs="0"/>

```

```

<xs:element ref="msci:endpoint-capabilities" minOccurs="0"/>
<xs:element ref="msci:is-robot" minOccurs="0"/>
<xs:element ref="msci:current-sidebar" minOccurs="0"/>
<xs:sequence minOccurs="0">
  <xs:element ref="cis:separator"/>
  <xs:element ref="msci:session-on-behalf-of" minOccurs="0"/>
  <xs:element ref="msci:in-conferencing-services" minOccurs="0"/>
  <xs:element ref="msci:languages" minOccurs="0"/>
  <xs:element ref="msci:is-pstn-endpoint" minOccurs="0"/>
  <xs:sequence minOccurs="0">
    <xs:element ref="cis:separator"/>
    <xs:element ref="msci:client-recording" minOccurs="0"/>
    <xs:sequence minOccurs="0">
      <xs:element ref="cis:separator"/>
      <xs:element ref="msci:endpoint-notification" minOccurs="0"/>
      <xs:sequence minOccurs="0">
        <xs:element ref="cis:separator"/>
        <xs:any namespace="##other" processContents="lax"
maxOccurs="unbounded"/>
      </xs:sequence>
    </xs:sequence>
  </xs:sequence>
</xs:sequence>
</xs:sequence>
</xs:sequence>
<xs:attribute name="entity" type="xs:string"/>
<xs:attribute name="state" type="state-type" use="optional" default="full"/>
<xs:attribute ref="msci:session-type" use="optional"/>
<xs:attribute ref="msci:epid" use="optional"/>
<xs:attribute ref="msci:sip-instance" use="optional"/>
<xs:attribute ref="msci:endpoint-uri" use="optional"/>
<xs:attribute ref="msci:refer-to-uri" use="optional"/>
<xs:attribute ref="msci:asserted-identity" use="optional"/>
<xs:anyAttribute namespace="##other" processContents="lax"/>
</xs:complexType>

<!--
  ENDPOINT STATUS TYPE
-->
<xs:simpleType name="endpoint-status-type">
  <xs:restriction base="xs:string">
    <xs:enumeration value="pending"/>
    <xs:enumeration value="dialing-out"/>
    <xs:enumeration value="dialing-in"/>
    <xs:enumeration value="alerting"/>
    <xs:enumeration value="on-hold"/>
    <xs:enumeration value="connected"/>
    <xs:enumeration value="muted-via-focus"/>
    <xs:enumeration value="disconnecting"/>
    <xs:enumeration value="disconnected"/>
  </xs:restriction>
</xs:simpleType>

<!--
  JOINING TYPE
-->
<xs:simpleType name="joining-type">
  <xs:restriction base="xs:string">
    <xs:enumeration value="dialed-in"/>
    <xs:enumeration value="dialed-out"/>
    <xs:enumeration value="focus-owner"/>
  </xs:restriction>
</xs:simpleType>

<!--
  DISCONNECTION TYPE
-->
<xs:simpleType name="disconnection-type">
  <xs:restriction base="xs:string">
    <xs:enumeration value="departed"/>

```

```

        <xs:enumeration value="booted"/>
        <xs:enumeration value="failed"/>
        <xs:enumeration value="busy"/>
    </xs:restriction>
</xs:simpleType>

<!--
    EXECUTION TYPE
-->
<xs:complexType name="execution-type">
    <xs:sequence>
        <xs:element name="when" type="xs:dateTime"
            minOccurs="0"/>
        <xs:element name="reason" type="xs:string"
            minOccurs="0"/>
        <xs:element name="by" type="xs:anyURI"
            minOccurs="0"/>
    </xs:sequence>
    <xs:anyAttribute namespace="##other" processContents="lax"/>
</xs:complexType>

<!--
    CALL TYPE
-->
<xs:complexType name="call-type">
    <xs:choice>
        <xs:element name="sip" type="sip-dialog-id-type"/>
        <xs:any namespace="##other" processContents="lax" minOccurs="0"
maxOccurs="unbounded"/>
    </xs:choice>
    <xs:anyAttribute namespace="##other" processContents="lax"/>
</xs:complexType>

<!--
    SIP DIALOG ID TYPE
-->
<xs:complexType name="sip-dialog-id-type">
    <xs:sequence>
        <xs:element name="display-text" type="xs:string" minOccurs="0"/>
        <xs:element name="call-id" type="xs:string"/>
        <xs:element name="from-tag" type="xs:string"/>
        <xs:element name="to-tag" type="xs:string"/>
        <xs:any namespace="##other" processContents="lax" minOccurs="0"
maxOccurs="unbounded"/>
    </xs:sequence>
    <xs:anyAttribute namespace="##other" processContents="lax"/>
</xs:complexType>

<!--
    MEDIA TYPE
-->
<xs:complexType name="media-type">
    <xs:sequence>
        <xs:element name="display-text" type="xs:string" minOccurs="0"/>
        <xs:element name="type" type="xs:string" minOccurs="0"/>
        <xs:element name="label" type="xs:string" minOccurs="0"/>
        <xs:element name="src-id" type="xs:string" minOccurs="0"/>
        <xs:element name="status" type="media-status-type" minOccurs="0"/>
        <xs:element ref="msci:media-ingress-filter" minOccurs="0">
            <xs:annotation>
                <xs:documentation>
                    If this element is not present, a value of 'unblock'
                    should be assumed
                </xs:documentation>
            </xs:annotation>
        </xs:element>
        <xs:element ref="msci:media-egress-filter" minOccurs="0"/>
    </xs:sequence>
</xs:complexType>

```



```

    <xs:sequence minOccurs="0">
      <xs:element ref="cis:separator"/>
      <xs:element ref="msci:to-mixer" minOccurs="0"/>
      <xs:element ref="msci:from-mixer" minOccurs="0"/>
      <xs:element ref="msci:media-state" minOccurs="0"/>
      <xs:element ref="msci:session-id" minOccurs="0"/>
      <xs:sequence minOccurs="0">
        <xs:element ref="cis:separator"/>
        <xs:element ref="msci:media-capabilities" minOccurs="0">
          <xs:annotation>
            <xs:documentation>
              This element corresponds to the media level capabilities
from an SDP
            </xs:documentation>
          </xs:annotation>
        </xs:element>
      <xs:element ref="msci:conf-media-filter" minOccurs="0"/>
      <xs:sequence minOccurs="0">
        <xs:element ref="cis:separator"/>
        <xs:element ref="msci:media-source-id" minOccurs="0" />
        <xs:element ref="msci:source-name" minOccurs="0"/>
        <xs:sequence minOccurs="0">
          <xs:element ref="cis:separator"/>
          <xs:any namespace="##other" processContents="lax"
maxOccurs="unbounded"/>
        </xs:sequence>
      </xs:sequence>
    </xs:sequence>
  </xs:sequence>
</xs:sequence>
</xs:sequence>
</xs:sequence>
<xs:attribute name="id" type="xs:string" use="required" />
<xs:anyAttribute namespace="##other" processContents="lax"/>
</xs:complexType>

<!--
  MEDIA STATUS TYPE
-->
<xs:simpleType name="media-status-type">
  <xs:restriction base="xs:string">
    <xs:enumeration value="recvonly"/>
    <xs:enumeration value="sendonly"/>
    <xs:enumeration value="sendrecv"/>
    <xs:enumeration value="inactive"/>
  </xs:restriction>
</xs:simpleType>

<!--
  SIDEBARS BY VAL TYPE
-->
<xs:complexType name="sidebars-by-val-type">
  <xs:sequence>
    <xs:element name="entry" type="conference-type" minOccurs="0"
maxOccurs="unbounded"/>
  </xs:sequence>
  <xs:attribute name="state" type="state-type" use="optional" default="full"/>
  <xs:anyAttribute namespace="##other" processContents="lax"/>
</xs:complexType>
</xs:schema>

```

6.3.2 confinfoextensions Namespace

This namespace is identified by the following URN:

<http://schemas.microsoft.com/rtc/2005/08/confinfoextensions>

```

<?xml version="1.0" encoding="utf-8"?>
<xs:schema
targetNamespace="http://schemas.microsoft.com/rtc/2005/08/confinfoextensions"
elementFormDefault="qualified"
attributeFormDefault="unqualified"
xmlns:ci="urn:ietf:params:xml:ns:conference-info"
xmlns:cis="urn:ietf:params:xml:ns:conference-info-separator"
xmlns:tns="http://schemas.microsoft.com/rtc/2005/08/confinfoextensions"
xmlns:msacp="http://schemas.microsoft.com/rtc/2005/08/acpconfinfoextensions"
xmlns:msav="http://schemas.microsoft.com/rtc/2005/08/avconfinfoextensions"
xmlns:msas="http://schemas.microsoft.com/rtc/2005/08/asconfinfoextensions"
xmlns:msdata="http://schemas.microsoft.com/rtc/2005/08/dataconfinfoextensions"
xmlns:msim="http://schemas.microsoft.com/rtc/2005/08/imconfinfoextensions"
xmlns:msci2="http://schemas.microsoft.com/rtc/2008/12/confinfoextensions"
xmlns:xs="http://www.w3.org/2001/XMLSchema"
xmlns="http://schemas.microsoft.com/rtc/2005/08/confinfoextensions"
xmlns:mmscu="http://schemas.microsoft.com/rtc/2009/03/commonmceuextensions"
>

    <!-- Bring in standard conferencing package separator -->
    <xs:import namespace="urn:ietf:params:xml:ns:conference-info-separator"
schemaLocation="ms-ci-separator.xsd"/>

    <!-- Bring in standard conferencing package -->
    <xs:import namespace="urn:ietf:params:xml:ns:conference-info" schemaLocation="ms-
ci.xsd"/>

    <!-- Bring in later extensions to this package -->
    <xs:import namespace="http://schemas.microsoft.com/rtc/2008/12/confinfoextensions"
schemaLocation="ms-ci-ext2.xsd"/>

    <!--
        This import brings the MCU settings definitions
    -->
    <xs:import namespace="http://schemas.microsoft.com/rtc/2005/08/acpconfinfoextensions"
schemaLocation="acpmcusettings.xsd"/>
    <xs:import namespace="http://schemas.microsoft.com/rtc/2005/08/avconfinfoextensions"
schemaLocation="avmcsusettings.xsd"/>
    <xs:import
namespace="http://schemas.microsoft.com/rtc/2005/08/dataconfinfoextensions"
schemaLocation="datamcsusettings.xsd"/>
    <xs:import namespace="http://schemas.microsoft.com/rtc/2005/08/imconfinfoextensions"
schemaLocation="immcusettings.xsd"/>
    <xs:import namespace="http://schemas.microsoft.com/rtc/2005/08/asconfinfoextensions"
schemaLocation="asmcsusettings.xsd"/>
    <xs:import namespace="http://schemas.microsoft.com/rtc/2009/03/commonmceuextensions"
schemaLocation="mcsucommon.xsd"/>

    <xs:element name="to-mixer" type="msav:media-routing-type"/>
    <xs:element name="from-mixer" type="msav:media-routing-type"/>

    <xs:element name="session-id" type="xs:string"/>
    <xs:element name="disclaimer" type="xs:string"/>
    <xs:element name="designated-presenter" type="xs:boolean"/>
    <xs:element name="trusted" type="xs:boolean"/>
    <xs:attribute name="conference-id" type="xs:string"/>
    <xs:element name="conference-id" type="xs:string"/>
    <xs:element name="conference-key" type="tns:conference-key-type"/>
    <xs:element name="current-sidebar" type="xs:anyURI"/>
    <xs:element name="last-update" type="xs:dateTime"/>

```

```

<xs:element name="last-activate" type="xs:dateTime"/>
<xs:element name="is-active" type="xs:boolean"/>
<xs:element name="expiry-time" type="xs:dateTime"/>
<xs:element name="organizer-roaming-data" type="tns:organizer-roaming-data-type"/>
<xs:element name="notification-data" type="tns:notification-data-type"/>
<xs:element name="encryption-key" type="tns:encryption-key-type"/>
<xs:element name="opaque" type="tns:encryption-key-opaque-type"/>
<xs:attribute name="mcu-type" type="xs:string"/>
<xs:element name="roles" type="ci:user-roles-type"/>
<xs:attribute name="smtp-address" type="xs:anyURI"/>
<xs:attribute name="endorser" type="xs:anyURI"/>
<xs:attribute name="endorser-display-name" type="xs:string"/>
<xs:element name="trusted-entities" type="ci:users-type"/>
<xs:element name="languages" type="ci:user-languages-type"/>
<xs:element name="encrypted-uri" type="tns:encrypted-content-type"/>
<xs:element name="is-pstn-endpoint" type="xs:boolean"/>
<xs:element name="anonymous-type-allowed" type="xs:boolean"/>
<xs:element name="lobby-capable" type="xs:boolean"/>
<xs:element name="join-url" type="xs:anyURI"/>
<xs:element name="autopromote-allowed" type="tns:autopromote-type"/>
<xs:element name="autopromote" type="tns:autopromote-type"/>
<xs:simpleType name="autopromote-type">
  <xs:restriction base="xs:unsignedInt"/>
</xs:simpleType>
<xs:element name="pstn-lobby-bypass-allowed" type="xs:boolean"/>
<xs:element name="pstn-lobby-bypass" type="xs:boolean"/>
<xs:element name="disclaimer-title" type="xs:string"/>
<xs:element name="recording-allowed" type="xs:boolean"/>
<xs:element name="externaluser-recording-allowed" type="xs:boolean"/>
<xs:element name="recording-notification" type="xs:boolean"/>
<xs:element name="server-mode" type="xs:unsignedInt"/>
<xs:element name="default-entry-exit-announcements" type="xs:boolean"/>
<xs:element name="anonymous-dialout-allowed" type="xs:boolean"/>
<!--
  Device Type Enumeration
-->
<xs:attribute name="device-type" type="tns:device-enumeration-type-ex"/>

```

```

<xs:simpleType name="device-enumeration-type-ex">
  <xs:union memberTypes="tns:device-enumeration-type xs:string"/>
</xs:simpleType>

<xs:simpleType name="device-enumeration-type">
  <xs:restriction base="xs:string">
    <xs:enumeration value="meetingRoom"/>
  </xs:restriction>
</xs:simpleType>

<!--
CUSTOM INVITE TYPE
-->
<xs:element name="custom-invite" type="tns:custom-invite-type"/>

<xs:complexType name="custom-invite-type">
  <xs:sequence>
    <xs:element name="logo-url" type="xs:anyURI" minOccurs="0"/>
    <xs:element name="legal-url" type="xs:anyURI" minOccurs="0"/>
    <xs:element name="help-url" type="xs:anyURI" minOccurs="0"/>
    <xs:element name="settings-url" type="xs:anyURI" minOccurs="0"/>
    <xs:element name="custom-footer-text" type="xs:string" minOccurs="0"/>
    <xs:any namespace="##other" processContents="lax" minOccurs="0"
maxOccurs="unbounded"/>
  </xs:sequence>
  <xs:anyAttribute namespace="##other" processContents="lax"/>
</xs:complexType>

<!-- Number of users in a meeting -->
<xs:attribute name="participant-count" type="xs:unsignedInt"/>

<!-- Indicates if the server supports the Endorse command -->
<xs:element name="endorse-allowed" type="xs:boolean"/>

<!-- Indicates server support for Main Video Hard Mute -->
<xs:element name="main-video-mute-allowed" type="xs:boolean"/>

<!-- Server support for Pano Video Hard Mute -->
<xs:element name="pano-video-mute-allowed" type="xs:boolean"/>

<!-- Indicates if the current conference supports large meetings. -->
<xs:element name="is-large-meeting" type="xs:boolean"/>

<!--
ENCRYPTION KEY OPAQUE TYPE
-->
<xs:complexType name="encryption-key-opaque-type">
  <xs:sequence>
    <xs:element name="issuing-server" type="xs:string"/>
    <xs:any namespace="##other" processContents="lax" minOccurs="0"
maxOccurs="unbounded"/>
  </xs:sequence>
  <xs:anyAttribute namespace="##other" processContents="lax"/>
</xs:complexType>

<!--
ENCRYPTION KEY TYPE
-->
<xs:complexType name="encryption-key-type">
  <xs:sequence>
    <xs:element name="x509-certificate" type="xs:base64Binary"/>
    <xs:any namespace="##other" processContents="lax" minOccurs="0"
maxOccurs="unbounded"/>
  </xs:sequence>
  <xs:anyAttribute namespace="##other" processContents="lax"/>
</xs:complexType>

```

```

<!--
  CONFERENCE KEY TYPE
-->
<xs:complexType name="conference-key-type">
  <xs:sequence>
    <xs:element name="cms-data" type="xs:base64Binary"/>
    <xs:element name="opaque" type="tns:encryption-key-opaque-type"
minOccurs="0"/>
    <xs:element ref="msci2:optional" minOccurs="0"/>
    <xs:sequence minOccurs="0">
      <xs:element ref="cis:separator"/>
      <xs:any namespace="##other" processContents="lax" minOccurs="0"
maxOccurs="unbounded"/>
    </xs:sequence>
  </xs:sequence>

  <xs:anyAttribute namespace="##other" processContents="lax"/>
</xs:complexType>

<!--
  ENCRYPTED CONTENT TYPE
-->
<xs:complexType name="encrypted-content-type">
  <xs:sequence>
    <xs:element name="cms-data" type="xs:base64Binary"/>
    <xs:any namespace="##other" processContents="lax" minOccurs="0"
maxOccurs="unbounded"/>
  </xs:sequence>

  <xs:anyAttribute namespace="##other" processContents="lax"/>
</xs:complexType>

<!--
  ORGANIZER ROAMING DATA TYPE
-->
<xs:complexType name="organizer-roaming-data-type">
  <xs:sequence>
    <xs:any namespace="##other" processContents="lax" minOccurs="0"
maxOccurs="unbounded"/>
  </xs:sequence>

  <xs:anyAttribute namespace="##other" processContents="lax"/>
</xs:complexType>

<!--
  NOTIFICATION DATA TYPE
-->
<xs:complexType name="notification-data-type">
  <xs:sequence>
    <xs:any namespace="##other" processContents="lax" minOccurs="0"
maxOccurs="unbounded"/>
  </xs:sequence>

  <xs:anyAttribute namespace="##other" processContents="lax"/>
</xs:complexType>

<!--
  Admission policy for the conference
-->
<xs:element name="admission-policy" type="tns:admission-policy-type"/>

<xs:simpleType name="admission-policy-type">
  <xs:restriction base="xs:string">
    <xs:enumeration value="closedAuthenticated"/>

```

```

        <xs:enumeration value="openAuthenticated"/>
        <xs:enumeration value="anonymous"/>
    </xs:restriction>
</xs:simpleType>

<!--
    PSTN bridging access information for the conference
-->
<xs:element name="pstn-access" type="tns:pstn-access-type"/>

<xs:simpleType name="pstn-meeting-id-type">
    <xs:restriction base="xs:string">
        <xs:pattern value="[1-9][0-9]*"/>
    </xs:restriction>
</xs:simpleType>

<xs:complexType name="pstn-access-type">
    <xs:sequence>
        <xs:element name="id" type="tns:pstn-meeting-id-type" minOccurs="0"/>
        <xs:element name="access-numbers" type="tns:pstn-access-numbers-type"
minOccurs="0"/>
        <xs:any namespace="##other" processContents="lax" minOccurs="0"
maxOccurs="unbounded"/>
    </xs:sequence>
    <xs:anyAttribute namespace="##other" processContents="lax"/>
</xs:complexType>

<xs:complexType name="pstn-access-numbers-type">
    <xs:sequence>
        <xs:element name="internal-url" type="xs:anyURI" minOccurs="0"/>
        <xs:element name="external-url" type="xs:anyURI" minOccurs="0"/>
        <xs:element name="region" type="tns:pstn-access-number-region-type"
minOccurs="0" maxOccurs="unbounded"/>
        <xs:element ref="msci2:default-region" minOccurs="0"/>
        <xs:sequence minOccurs="0">
            <xs:element ref="cis:separator"/>
            <xs:any namespace="##other" processContents="lax" maxOccurs="unbounded"/>
        </xs:sequence>
    </xs:sequence>
    <xs:anyAttribute namespace="##other" processContents="lax"/>
</xs:complexType>

<xs:complexType name="pstn-access-number-region-type">
    <xs:sequence>
        <xs:element name="access-number" type="tns:pstn-access-number-type"
minOccurs="0" maxOccurs="unbounded"/>
        <xs:any namespace="##other" processContents="lax" minOccurs="0"
maxOccurs="unbounded"/>
    </xs:sequence>
    <xs:attribute name="name" type="xs:string" use="required"/>
    <xs:anyAttribute namespace="##other" processContents="lax"/>
</xs:complexType>

<xs:complexType name="pstn-access-number-type">
    <xs:sequence>
        <xs:element name="language" type="tns:pstn-access-number-language-type"
minOccurs="0" maxOccurs="unbounded"/>
        <xs:element name="number" type="xs:string"/>
        <xs:any namespace="##other" processContents="lax" minOccurs="0"
maxOccurs="unbounded"/>
    </xs:sequence>
    <xs:anyAttribute namespace="##other" processContents="lax"/>
</xs:complexType>

<xs:complexType name="pstn-access-number-language-type">
    <xs:sequence>
        <xs:any namespace="##other" processContents="lax" minOccurs="0"
maxOccurs="unbounded"/>
    </xs:sequence>
</xs:complexType>

```

```

        </xs:sequence>
        <xs:attribute name="tag" type="xs:language" use="required"/>
        <xs:attribute name="lcid" type="xs:nonNegativeInteger" use="optional"/>
        <xs:anyAttribute namespace="##other" processContents="lax"/>
    </xs:complexType>

    <!--
    CONFERENCE VIEW TYPE
    -->
    <xs:element name="conference-view" type="tns:conference-view-type"/>

    <xs:complexType name="conference-view-type">
        <xs:sequence>
            <xs:element name="entity-view" type="entity-view-type" minOccurs="0"
maxOccurs="unbounded"/>
            <xs:any namespace="##other" processContents="lax" minOccurs="0"
maxOccurs="unbounded"/>
        </xs:sequence>

        <xs:attribute ref="ci:state" default="full"/>
        <xs:anyAttribute namespace="##other" processContents="lax"/>
    </xs:complexType>

    <!--
    ENTITY VIEW TYPE
    -->
    <xs:complexType name="entity-view-type">
        <xs:sequence>
            <xs:element name="entity-capabilities" type="entity-capabilities-type"
minOccurs="0"/>
            <xs:element name="entity-policy" type="entity-policy-type" minOccurs="0"/>
            <xs:element name="entity-settings" type="entity-settings-type"
minOccurs="0"/>
            <xs:element name="entity-state" type="entity-state-type" minOccurs="0"/>
            <xs:element name="entity-shared-data" type="entity-shared-data-type"
minOccurs="0"/>
            <xs:any namespace="##other" processContents="lax" minOccurs="0"
maxOccurs="unbounded"/>
        </xs:sequence>

        <xs:attribute ref="ci:state" default="full"/>
        <xs:attribute name="entity" type="xs:anyURI"/>
        <xs:anyAttribute namespace="##other" processContents="lax"/>
    </xs:complexType>

    <xs:element name="modal-parameters" type="tns:modal-parameters-type"/>
    <xs:complexType name="modal-parameters-type">
        <xs:sequence>
            <xs:choice>
                <xs:element name="audio-parameters" type="msav:audio-parameters-type"
minOccurs="0"/>
                <xs:element name="video-parameters" type="msav:video-parameters-type"
minOccurs="0"/>
            </xs:choice>
            <xs:any namespace="##other" processContents="lax" minOccurs="0"
maxOccurs="unbounded"/>
        </xs:sequence>
    </xs:complexType>

    <xs:element name="conference-media-states" type="tns:conference-media-states-type"/>
    <xs:complexType name="conference-media-states-type">
        <xs:sequence>
            <xs:element name="entry" type="conference-media-state-type" minOccurs="0"
maxOccurs="unbounded"/>
        </xs:sequence>
        <xs:attribute ref="ci:state" use="required"/>
        <xs:anyAttribute namespace="##other" processContents="lax"/>
    </xs:complexType>

```

```

<xs:element name="conference-media-state" type="tns:conference-media-state-type"/>
<xs:complexType name="conference-media-state-type">
  <xs:sequence>
    <xs:element name="displayText" type="xs:string" minOccurs="0"/>
    <xs:element name="webPage" type="xs:anyURI" minOccurs="0"/>
    <xs:element name="userCount" type="xs:unsignedInt" minOccurs="0"/>
    <xs:element name="active" type="xs:boolean" minOccurs="0"/>
    <xs:element name="locked" type="xs:boolean" minOccurs="0"/>
    <xs:element name="recording" type="xs:boolean" minOccurs="0"/>
    <xs:element name="mixing" type="xs:boolean" minOccurs="0"/>
    <xs:element name="allMuted" type="xs:boolean" minOccurs="0"/>
    <xs:element name="mediums" type="ci:conference-media-type" minOccurs="0"/>
    <xs:element ref="msav:audio-video-media-state" minOccurs="0"/>
    <xs:sequence minOccurs="0">
      <xs:element ref="cis:separator"/>
      <xs:any namespace="##other" processContents="lax" maxOccurs="unbounded"/>
    </xs:sequence>
  </xs:sequence>
  <xs:attribute ref="ci:state" use="required"/>
  <xs:attribute name="entity" type="xs:anyURI"/>
  <xs:anyAttribute namespace="##other" processContents="lax"/>
</xs:complexType>

<xs:element name="conference-mcu-policies" type="tns:mcu-policies-type"/>

<xs:complexType name="mcu-policies-type">
  <xs:annotation>
    <xs:documentation>
      TBD
    </xs:documentation>
  </xs:annotation>

  <xs:sequence>
    <xs:element name="guid" type="xs:anyURI" minOccurs="0"/>
    <xs:any namespace="##other" processContents="lax" minOccurs="0"/>
  </xs:sequence>

  <xs:attribute name="entity" type="xs:anyURI" use="required"/>
  <xs:attribute name="version" type="xs:string" use="required">
    <xs:annotation>
      <xs:documentation>
        Identifies the version of MCU settings specified.
      </xs:documentation>
    </xs:annotation>
  </xs:attribute>
</xs:complexType>

<!--
  ENTITY CAPABILITIES TYPE
-->
<xs:complexType name="entity-capabilities-type">
  <xs:sequence>
    <xs:choice minOccurs="0">
      <xs:element ref="msacp:capabilities"/>
      <xs:element ref="msav:capabilities" />
      <!-- <xs:element ref="msim:capabilities"/> -->
    </xs:choice>
    <xs:sequence minOccurs="0">
      <xs:element ref="cis:separator"/>
      <xs:element ref="msdata:capabilities" minOccurs="0"/>
      <xs:element ref="msas:capabilities" minOccurs="0"/>
      <xs:sequence minOccurs="0">
        <xs:element ref="cis:separator"/>
        <xs:any namespace="##other" processContents="lax"
maxOccurs="unbounded"/>

```



```

        </xs:sequence>
    </xs:sequence>
</xs:sequence>

    <xs:anyAttribute namespace="##other" processContents="lax"/>
</xs:complexType>

<!--
    ENTITY POLICY TYPE
-->
<xs:complexType name="entity-policy-type">
    <xs:sequence>
        <xs:element name="guid" type="xs:anyURI" minOccurs="0"/>
        <xs:any namespace="##other" processContents="lax" minOccurs="0"
maxOccurs="unbounded"/>
    </xs:sequence>

    <xs:attribute ref="msci2:policyAssignment" use="optional"/>
    <xs:anyAttribute namespace="##other" processContents="lax"/>
</xs:complexType>

<!--
    ENTITY SETTINGS TYPE
-->
<xs:complexType name="entity-settings-type">
    <xs:sequence>
        <xs:element name="mediaFiltersRules" type="tns:media-filters-rules-type"
minOccurs="0" />
        <xs:element name="media" type="ci:conference-media-type" minOccurs="0" />
        <xs:choice minOccurs="0">
            <xs:element ref="msacp:settings"/>
            <xs:element ref="msav:settings"/>
            <xs:element ref="msdata:settings"/>
            <xs:element ref="msim:settings"/>
        </xs:choice>
        <xs:sequence minOccurs="0">
            <xs:element ref="cis:separator"/>
            <xs:element ref="msmcu:conf-media-filters-rules" minOccurs="0"
maxOccurs="unbounded" />
            <xs:sequence minOccurs="0">
                <xs:element ref="cis:separator"/>
                <xs:any namespace="##other" processContents="lax"
maxOccurs="unbounded"/>
            </xs:sequence>
        </xs:sequence>
        <xs:anyAttribute namespace="##other" processContents="lax"/>
    </xs:complexType>

<!--
    ENTITY STATE TYPE
-->
<xs:complexType name="entity-state-type">
    <xs:sequence>
        <xs:element name="displayText" type="xs:string" minOccurs="0"/>
        <xs:element name="userCount" type="xs:unsignedInt" minOccurs="0"/>
        <xs:element name="active" type="xs:boolean" minOccurs="0"/>
        <xs:element name="locked" type="xs:boolean" minOccurs="0"/>
        <xs:element name="mediaFiltersRules" type="tns:media-filters-rules-type"
minOccurs="0"/>
        <xs:element name="recording" type="recording-type" minOccurs="0" />
        <xs:element name="media" type="ci:conference-media-type" minOccurs="0"/>
        <xs:choice minOccurs="0">
            <xs:element ref="msacp:state"/>
            <xs:element ref="msav:state"/>
        </xs:choice>
        <xs:sequence minOccurs="0">
            <xs:element ref="cis:separator"/>
            <xs:element ref="msas:session-ids" minOccurs="0"/>
        </xs:sequence>
    </xs:sequence>

```

```

        <xs:sequence minOccurs="0">
            <xs:element ref="cis:separator"/>
            <xs:element ref="msdata:data-mcu-state" minOccurs="0" />
            <xs:element ref="msmcu:permission-options" minOccurs="0"/>
            <xs:element ref="msmcu:permissions" minOccurs="0"/>
            <xs:element ref="msmcu:presentation-mode-capable" minOccurs="0"/>
            <xs:element ref="msmcu:entry-exit-announcements" minOccurs="0"/>
            <xs:sequence minOccurs="0">
                <xs:element ref="cis:separator"/>
                <xs:element ref="msmcu:multi-view-capable" minOccurs="0"/>
                <xs:element ref="msmcu:video-presentation-mode-capable"
minOccurs="0"/>
            <xs:element ref="msmcu:conf-media-filters-rules" minOccurs="0"
maxOccurs="unbounded" />
            <xs:sequence minOccurs="0">
                <xs:element ref="cis:separator"/>
                <xs:any namespace="##other" processContents="lax"
maxOccurs="unbounded"/>
            </xs:sequence>
        </xs:sequence>
    </xs:sequence>
    </xs:sequence>
    </xs:sequence>
    </xs:sequence>
    <xs:attribute name="application" type="xs:string"/>
    <xs:anyAttribute namespace="##other" processContents="lax"/>
</xs:complexType>

<!--
    ENTITY SHARED DATA TYPE
-->
<xs:complexType name="entity-shared-data-type">
    <xs:sequence>
        <xs:choice minOccurs="0">
            <xs:element ref="msacp:shared-data"/>
            <!-- <xs:element ref="msav:shared-data"/> -->
            <!-- <xs:element ref="msdata:shared-data"/> -->
            <!-- <xs:element ref="msim:shared-data"/> -->
        </xs:choice>
        <xs:sequence minOccurs="0">
            <xs:element ref="cis:separator"/>
            <xs:any namespace="##other" processContents="lax" maxOccurs="unbounded"/>
        </xs:sequence>
    </xs:sequence>
    <xs:anyAttribute namespace="##other" processContents="lax"/>
</xs:complexType>

<!--
    Media filters rules
-->
<xs:complexType name="media-filters-rules-type">
    <xs:sequence>
        <xs:element name="mayModifyOwnFilters" type="tns:boolean-role-rule-type"
minOccurs="0" maxOccurs="unbounded"/>
        <xs:element name="initialFilters" type="tns:media-filters-role-rule-type"
minOccurs="0" maxOccurs="unbounded"/>
        <xs:element ref="msav:type" minOccurs="0" />
        <xs:sequence minOccurs="0">
            <xs:element ref="cis:separator"/>
            <xs:any namespace="##other" processContents="lax" minOccurs="0"
maxOccurs="unbounded"/>
        </xs:sequence>
    </xs:sequence>
    <xs:anyAttribute namespace="##other" processContents="lax"/>
</xs:complexType>

<xs:complexType name="boolean-role-rule-type">
    <xs:sequence>
        <xs:element name="role" type="xs:string"/>
        <xs:element name="value" type="xs:boolean"/>

```

```

        <xs:any namespace="##other" processContents="lax" minOccurs="0"
maxOccurs="unbounded"/>
    </xs:sequence>
    <xs:anyAttribute namespace="##other" processContents="lax"/>
</xs:complexType>

<xs:complexType name="media-filters-role-rule-type">
    <xs:sequence>
        <xs:element name="role" type="xs:string"/>
        <xs:element name="ingressFilter" type="tns:media-filter-type" minOccurs="0"/>
        <xs:element name="egressFilter" type="tns:media-filter-type" minOccurs="0"/>
        <xs:any namespace="##other" processContents="lax" minOccurs="0"
maxOccurs="unbounded"/>
    </xs:sequence>
    <xs:anyAttribute namespace="##other" processContents="lax"/>
</xs:complexType>

<!--
    MS Authentication Type - LCS Extension
-->
<xs:element name="authMethod" type="tns:auth-method-type"/>

<xs:simpleType name="auth-method-type">
    <xs:restriction base="xs:string">
        <xs:enumeration value="enterprise"/>
        <xs:enumeration value="anonymous"/>
        <xs:enumeration value="federated"/>
    </xs:restriction>
</xs:simpleType>

<!--
    MS Role Type - LCS Extension
-->
<xs:simpleType name="ms-role-type">
    <xs:restriction base="xs:string">
        <xs:enumeration value="attende" />
        <xs:enumeration value="presenter" />
    </xs:restriction>
</xs:simpleType>

<xs:element name="pstnRole" type="tns:ms-role-type"/>

<!--
    USER ACCESS TYPE
-->
<xs:element name="accessMethod" type="tns:access-method-type"/>

<xs:simpleType name="access-method-type">
    <xs:restriction base="xs:string">
        <xs:enumeration value="external"/>
        <xs:enumeration value="internal"/>
    </xs:restriction>
</xs:simpleType>

<!--
    CLIENT INFO TYPE
-->
<xs:element name="clientInfo" type="tns:client-info-type"/>

<xs:complexType name="client-info-type">
    <xs:sequence>
        <xs:element name="conversation-id" type="xs:string" minOccurs="0"/>
        <xs:element name="thread-id" type="xs:string" minOccurs="0"/>
        <xs:sequence minOccurs="0">
            <xs:element ref="cis:separator" />
            <xs:element ref="msci2:user-agent" minOccurs="0" maxOccurs="1" />
            <xs:element ref="msci2:lobby-capable" minOccurs="0"/>
            <xs:sequence minOccurs="0">

```

```

                <xs:element ref="cis:separator" />
                <xs:any namespace="##other" processContents="lax" minOccurs="0"
maxOccurs="unbounded"/>
            </xs:sequence>
        </xs:sequence>
    </xs:sequence>
</xs:complexType>

<!--
    ORGANIZER TYPE
-->
<xs:element name="organizer" type="tns:organizer-type"/>

<xs:complexType name="organizer-type">
    <xs:sequence>
        <xs:element name="entity" type="xs:anyURI" minOccurs="0"/>
        <xs:element name="display-name" type="xs:string" minOccurs="0"/>
        <xs:element ref="msci2:immutable-id" minOccurs="0"/>
        <xs:sequence minOccurs="0" >
            <xs:element ref="cis:separator"/>
            <xs:any namespace="##other" processContents="lax" minOccurs="0"
maxOccurs="unbounded"/>
        </xs:sequence>
    </xs:sequence>
</xs:complexType>

<!--
    SESSION-ON-BEHALF-OF TYPE
-->
<xs:element name="session-on-behalf-of" type="tns:session-on-behalf-of-type"/>

<xs:complexType name="session-on-behalf-of-type">
    <xs:sequence>
        <xs:element name="entity" type="xs:anyURI" minOccurs="1"/>
        <xs:any namespace="##other" processContents="lax" minOccurs="0"
maxOccurs="unbounded"/>
    </xs:sequence>
    <xs:anyAttribute namespace="##other" processContents="lax"/>
</xs:complexType>

<!--
    IN-CONFERENCING-SERVICES TYPE
-->
<xs:element name="in-conferencing-services" type="tns:in-conferencing-services-type"/>

<xs:complexType name="in-conferencing-services-type">
    <xs:sequence>
        <xs:element name="entry" type="tns:in-conferencing-services-entry-type"
minOccurs="1" maxOccurs="unbounded"/>
        <xs:any namespace="##other" processContents="lax" minOccurs="0"
maxOccurs="unbounded"/>
    </xs:sequence>
    <xs:anyAttribute namespace="##other" processContents="lax"/>
</xs:complexType>

<xs:complexType name="in-conferencing-services-entry-type">
    <xs:sequence>
        <xs:element name="active" type="xs:boolean" minOccurs="1"/>
        <xs:any namespace="##other" processContents="lax" minOccurs="0"
maxOccurs="unbounded"/>
    </xs:sequence>
    <xs:attribute name="type" type="tns:in-conferencing-service-types-ex"/>
    <xs:anyAttribute namespace="##other" processContents="lax"/>
</xs:complexType>

<xs:simpleType name="in-conferencing-service-types-ex">
    <xs:union memberTypes="tns:in-conferencing-service-types xs:string"/>
</xs:simpleType>

```

```

<xs:simpleType name="in-conferencing-service-types">
  <xs:restriction base="xs:string">
    <xs:enumeration value="personalVirtualAssistant"/>
    <xs:enumeration value="entryExitAnnouncements"/>
  </xs:restriction>
</xs:simpleType>

<!--
  CLIENT RECORDING
-->
<xs:complexType name="client-recording-type">
  <xs:sequence>
    <xs:any namespace="##other" minOccurs="0" maxOccurs="unbounded"
processContents="lax"/>
  </xs:sequence>
  <xs:anyAttribute namespace="##other" processContents="lax"/>
</xs:complexType>

<xs:element name="client-recording" type="tns:client-recording-type"/>

<!--
  MEDIA FILTER
-->
<xs:element name="media-filter" type="tns:media-filter-type"/>
<xs:element name="media-ingress-filter" type="tns:media-filter-type"/>
<xs:element name="media-egress-filter" type="tns:media-filter-type"/>

<xs:simpleType name="media-filter-type">
  <xs:restriction base="xs:string">
    <xs:enumeration value="block" />
    <xs:enumeration value="unblock" />
  </xs:restriction>
</xs:simpleType>

<xs:element name="conf-media-filter" type="tns:conf-media-filter-type"/>

<xs:complexType name="conf-media-filter-type">
  <xs:attribute name="filter" type="tns:media-filter-type" use="required"/>
  <xs:attribute name="duration" type="xs:int" use="optional"/>
  <xs:anyAttribute namespace="##other" processContents="lax"/>
</xs:complexType>

<!-- Media-Source-Id referenced in Media-Type-->
<xs:element name="media-source-id" type="xs:unsignedInt" />

<!-- source-name referenced in Media-Type-->
<xs:element name="source-name" type="xs:string"/>

<!--
  Post dial strings
-->
<xs:element name="post-dial" type="xs:string"/>

<!--
  pstnLeaderPasscode
-->
<xs:element name="pstnLeaderPasscode" type="xs:string"/>

<!--
  endpoint capabilities
-->
<xs:element name="endpoint-capabilities" type="endpoint-capabilities-type"/>

<xs:complexType name="endpoint-capabilities-type">
  <xs:sequence>
    <xs:choice minOccurs="0">
      <xs:element ref="msacp:endpoint-capabilities"/>
      <xs:element ref="msav:endpoint-capabilities"/>
      <xs:element ref="msdata:endpoint-capabilities"/>
    </xs:choice>
  </xs:sequence>
</xs:complexType>

```

```

        <xs:element ref="msim:endpoint-capabilities"/>
    </xs:choice>
    <xs:sequence minOccurs="0">
        <xs:element ref="cis:separator" />
        <xs:choice minOccurs="0">
            <xs:element ref="msmcu:session-capabilities"/>
        </xs:choice>
        <xs:sequence minOccurs="0">
            <xs:element ref="cis:separator"/>
            <xs:any namespace="##other" processContents="lax"
maxOccurs="unbounded"/>
        </xs:sequence>
    </xs:sequence>
</xs:sequence>
</xs:sequence>
<xs:anyAttribute namespace="##other" processContents="lax"/>
</xs:complexType>

<!--
    endpoint notification
-->
<xs:element name="endpoint-notification" type="endpoint-notification-type"/>

<xs:complexType name="endpoint-notification-type">
    <xs:sequence>
        <xs:element name="in-room-users" type="in-room-users-type" minOccurs="0"/>
        <xs:sequence minOccurs="0">
            <xs:element ref="cis:separator"/>
            <xs:any namespace="##other" processContents="lax" maxOccurs="unbounded"/>
        </xs:sequence>
    </xs:sequence>
    <xs:anyAttribute namespace="##other" processContents="lax"/>
</xs:complexType>

<!--
    in room users
-->
<xs:complexType name="in-room-users-type">
    <xs:sequence>
        <xs:element name="user" type="in-room-user-type" minOccurs="0"
maxOccurs="unbounded"/>
        <xs:sequence minOccurs="0">
            <xs:element ref="cis:separator"/>
            <xs:any namespace="##other" processContents="lax" maxOccurs="unbounded"/>
        </xs:sequence>
    </xs:sequence>
    <xs:attribute name="state" type="ci:state-type" use="optional" default="full"/>
    <xs:anyAttribute namespace="##other" processContents="lax" />
</xs:complexType>

<!--
    in room user
-->
<xs:complexType name="in-room-user-type">
    <xs:sequence>
        <xs:element name="display-text" type="xs:string" minOccurs="0"/>
        <xs:element name="auth-method" type="tns:auth-method-type" minOccurs="0"/>
        <xs:sequence minOccurs="0">
            <xs:element ref="cis:separator"/>
            <xs:any namespace="##other" processContents="lax" maxOccurs="unbounded"/>
        </xs:sequence>
    </xs:sequence>
    <xs:attribute name="entity" type="xs:anyURI"/>
    <xs:attribute name="state" type="ci:state-type" use="optional" default="full"/>
    <xs:anyAttribute namespace="##other" processContents="lax" />
</xs:complexType>

<!--
    media capabilities

```

```

-->
<xs:element name="media-capabilities" type="tns:media-capabilities-type"/>

<xs:complexType name="media-capabilities-type">
  <xs:sequence>
    <xs:element ref="msas:media-capabilities" minOccurs="0"/>
    <xs:sequence minOccurs="0">
      <xs:element ref="cis:separator"/>
      <xs:any namespace="##other" processContents="lax" maxOccurs="unbounded"/>
    </xs:sequence>
  </xs:sequence>
  <xs:anyAttribute namespace="##other" processContents="lax"/>
</xs:complexType>

<!-- IS ROBOT ELEMENT -->
<xs:element name="is-robot" type="xs:boolean"/>

<!--
  Hash code string
-->
<xs:element name="hash-code" type="xs:string"/>

<!-- RECORDING TYPE -->
<xs:complexType name="recording-type">
  <xs:sequence>
    <xs:element name="active" type="xs:boolean" minOccurs="0"/>
    <xs:element name="error" type="error-type" minOccurs="0"/>
    <xs:element name="paused" type="xs:boolean" minOccurs="0"/>
    <xs:element name="recorded-media" type="recorded-media-entry-collection-type"
minOccurs="0"/>
  </xs:sequence>
  <xs:attribute name="id" type="xs:string" use="required"/>
</xs:complexType>

<!-- RECORDING ENTITIES ELEMENT -->
<xs:element name="recording-entities" type="recording-entity-collection-type"/>

<!-- RECORDING ENTITY COLLECTION TYPE -->
<xs:complexType name="recording-entity-collection-type">
  <xs:sequence>
    <xs:element name="recording-entity" type="recording-entity-type" minOccurs="0"
maxOccurs="unbounded"/>
  </xs:sequence>
</xs:complexType>

<!-- RECORDING ENTITY TYPE -->
<xs:complexType name="recording-entity-type">
  <xs:sequence>
    <xs:element name="recorded-media" type="recorded-media-entry-collection-type"/>
  </xs:sequence>
  <xs:attribute name="entity" type="xs:anyURI" use="required"/>
</xs:complexType>

<!-- RECORDED MEDIA ENTRY COLLECTION TYPE -->
<xs:complexType name="recorded-media-entry-collection-type">
  <xs:sequence>
    <xs:element name="entry" type="recorded-media-entry-type" minOccurs="0"
maxOccurs="unbounded"/>
  </xs:sequence>
</xs:complexType>

<!-- RECORDED MEDIA ENTRY TYPE -->
<xs:complexType name="recorded-media-entry-type">
  <xs:sequence>
    <xs:element name="error" type="error-type" minOccurs="0"/>
  </xs:sequence>
  <xs:attribute name="type" type="xs:string" use="required"/>
</xs:complexType>

```

```

<!-- ERROR ELEMENT -->
<xs:element name="error" type="error-type"/>

<!-- ERROR TYPE -->
<xs:complexType name="error-type">
  <xs:sequence>
    <xs:element name="code" type="xs:string"/>
    <xs:element name="description" type="xs:string" minOccurs="0"/>
  </xs:sequence>
</xs:complexType>

<!-- session-type string -->
<xs:attribute name="session-type" type="xs:string"/>

<!-- epid -->
<xs:attribute name="epid" type="xs:string"/>

<!-- sip-instance-->
<xs:attribute name="sip-instance" type="xs:string"/>

<!-- endpoint-uri uri -->
<xs:attribute name="endpoint-uri" type="xs:anyURI"/>

<!-- refer-to-uri uri -->
<xs:attribute name="refer-to-uri" type="xs:anyURI"/>

<!-- asserted-identity -->
<xs:attribute name="asserted-identity" type="xs:string"/>

<!--
SESSION DESCRIPTION TYPE: carries SDP for now just a string
-->
<xs:element name="session-description" type="tns:session-description-type"/>

<xs:complexType name="session-description-type">
  <xs:sequence>
    <xs:element name="sdp-string" type="xs:string" minOccurs="0" />
    <xs:any namespace="##other" processContents="lax" minOccurs="0"
maxOccurs="unbounded" />
  </xs:sequence>
</xs:complexType>

<!--
MEDIA STATE TYPE: This provides the state of the media
-->
<xs:element name="media-state" type="tns:media-state-type-ex"/>

<xs:simpleType name="media-state-type-ex">
  <xs:union memberTypes="tns:media-state-type xs:string"/>
</xs:simpleType>

<xs:simpleType name="media-state-type">
  <xs:restriction base="xs:string">
    <xs:enumeration value="pending"/>
    <xs:enumeration value="disconnected"/>
    <xs:enumeration value="offering"/>
    <xs:enumeration value="trying"/>
    <xs:enumeration value="proceeding"/>
    <xs:enumeration value="ringing"/>
    <xs:enumeration value="joining"/>
    <xs:enumeration value="connected"/>
    <xs:enumeration value="hold"/>
    <xs:enumeration value="forwarding"/>
    <xs:enumeration value="transferring"/>
  </xs:restriction>
</xs:simpleType>

<!--
SERVER NOTIFICATION REPROXY: Indicates if the message (notification) was reproxied.

```



```

-->
<xs:attribute name="is-proxied" type="xs:boolean"/>
</xs:schema>

```

Following extensions exist for the namespace
(<http://schemas.microsoft.com/rtc/2005/08/confinfoextensions>) defined above.

```

<?xml version="1.0" encoding="utf-8"?> <xs:schema
targetNamespace="http://schemas.microsoft.com/rtc/2008/12/confinfoextensions"
elementFormDefault="qualified"
attributeFormDefault="unqualified"
xmlns:cis="urn:ietf:params:xml:ns:conference-info-separator"
xmlns:tns="http://schemas.microsoft.com/rtc/2008/12/confinfoextensions"
xmlns:xs="http://www.w3.org/2001/XMLSchema"
xmlns="http://schemas.microsoft.com/rtc/2008/12/confinfoextensions">

  <xs:import namespace="urn:ietf:params:xml:ns:conference-info-separator"
schemaLocation="ms-ci-separator.xsd"/>

  <xs:element name="optional" type="xs:boolean"/>

  <xs:element name="user-agent" type="xs:string">
    <xs:annotation>
      <xs:documentation>
        String element intended to convey user endpoint's client version (for
        inferring endpoint capabilities of older clients)
      </xs:documentation>
    </xs:annotation>
  </xs:element>

  <xs:attribute name="policyAssignment" type="xs:string"/>

  <xs:element name="lobby-capable" type="xs:boolean"/>

  <!-- Specified the organizers default region -->
  <xs:element name="default-region" type="xs:string"/>

  <!-- An id for a user that will remain immutable, even if the SIP URI changes -->
  <xs:element name="immutable-id" type="xs:string"/>

</xs:schema>

```

6.3.3 conference-info-separator Namespace

This namespace is identified by the following URN:

urn:ietf:params:xml:ns:conference-info-separator

```

<?xml version="1.0" encoding="utf-8"?>
<xs:schema targetNamespace="urn:ietf:params:xml:ns:conference-info-separator"
elementFormDefault="qualified" attributeFormDefault="unqualified"
xmlns:tns="urn:ietf:params:xml:ns:conference-info-separator"
xmlns:xs="http://www.w3.org/2001/XMLSchema" xmlns="urn:ietf:params:xml:ns:conference-
info-separator">

  <!--
  This defines a separator marking the beginning of extensions
  -->
  <xs:element name="separator">
    <xs:complexType/></xs:complexType>
  </xs:element>

```

```
</xs:schema>
```

6.3.4 dataconfinfoextensions Namespace

This namespace is identified by the following URN:

<http://schemas.microsoft.com/rtc/2005/08/dataconfinfoextensions>

```
<?xml version="1.0" encoding="utf-8"?> <xs:schema
  targetNamespace="http://schemas.microsoft.com/rtc/2005/08/dataconfinfoextensions"
  elementFormDefault="qualified"
  attributeFormDefault="unqualified"
  version="1.0"
  xmlns:tns="http://schemas.microsoft.com/rtc/2005/08/dataconfinfoextensions"
  xmlns:cis="urn:ietf:params:xml:ns:conference-info-separator"
  xmlns:msmcu="http://schemas.microsoft.com/rtc/2009/03/commonmcuextensions"
  xmlns:xs="http://www.w3.org/2001/XMLSchema">

  <!-- This imports the standard separator -->
  <xs:import namespace="urn:ietf:params:xml:ns:conference-info-separator"
    schemaLocation="ms-ci-separator.xsd" />

  <!--
    This imports referenced elements added to DMCU setting/state after W14
  -->
  <xs:import namespace="http://schemas.microsoft.com/rtc/2009/03/commonmcuextensions"
    schemaLocation="mcucommon.xsd"/>

  <xs:simpleType name="app-viewing-behavior-type">
    <xs:annotation>
      <xs:documentation>
        Determines what form of application / desktop sharing to use for a
conference
      </xs:documentation>
    </xs:annotation>
    <xs:restriction base="xs:string">
      <xs:enumeration value="disabled"/>
      <xs:enumeration value="enableWithoutSharingControl"/>
      <xs:enumeration value="enableWithSharingOfOnlyASingleApplication"/>
      <xs:enumeration value="enableWithFullSharing"/>
    </xs:restriction>
  </xs:simpleType>

  <xs:simpleType name="conferencing-type-type">
    <xs:annotation>
      <xs:documentation>
        Determines whether this is a presentation or escalation conference
      </xs:documentation>
    </xs:annotation>
    <xs:restriction base="xs:string">
      <xs:enumeration value="presentation"/>
      <xs:enumeration value="collaboration"/>
    </xs:restriction>
  </xs:simpleType>

  <xs:complexType name="settings-type">
    <xs:sequence>
      <xs:element name="app-viewing-behavior" type="tns:app-viewing-behavior-
type"/>
      <xs:element name="conferencing-type" type="tns:conferencing-type-type"
minOccurs="0" maxOccurs="1"/>
      <xs:any namespace="##other" processContents="lax" minOccurs="0"
maxOccurs="unbounded" />
    </xs:sequence>
  </xs:complexType>
  <xs:element name="settings" type="tns:settings-type"/>
```

```

    <xs:complexType name="endpoint-capabilities-type">
      <xs:sequence>
        <xs:any namespace="##any" processContents="lax" minOccurs="0"
maxOccurs="unbounded"/>
      </xs:sequence>
    </xs:complexType>
    <xs:element name="endpoint-capabilities" type="tns:endpoint-capabilities-type"/>

    <xs:complexType name="data-mcu-state-type">
      <xs:sequence>
        <xs:element name="hasContent" type="xs:boolean" minOccurs="0" />
        <xs:element name="hasContentInMeeting" type="xs:boolean" minOccurs="0" />
        <xs:element name="hasPresentedContent" type="xs:boolean" minOccurs="0" />
        <xs:element ref="msmcu:hasWacConnectivity" minOccurs="0" />
        <xs:sequence minOccurs="0">
          <xs:element ref="cis:separator"/>
          <xs:any namespace="##other" processContents="lax" maxOccurs="unbounded"
/>
        </xs:sequence>
      </xs:sequence>
    </xs:complexType>
    <xs:element name="data-mcu-state" type="tns:data-mcu-state-type" />

    <xs:complexType name="capabilities-type">
      <xs:sequence>
        <xs:element name="supported-content-type" type="xs:string" minOccurs="0"
maxOccurs="unbounded" />
        <xs:any namespace="##other" processContents="lax" minOccurs="0"
maxOccurs="unbounded" />
      </xs:sequence>
    </xs:complexType>
    <xs:element name="capabilities" type="tns:capabilities-type"/>

  </xs:schema>

```

6.3.5 avconfinfoextensions Namespace

This namespace is identified by the following URN:

<http://schemas.microsoft.com/rtc/2005/08/avconfinfoextensions>

```

<?xml version="1.0" encoding="utf-8"?> <xs:schema
  targetNamespace="http://schemas.microsoft.com/rtc/2005/08/avconfinfoextensions"
  elementFormDefault="qualified"
  attributeFormDefault="unqualified"
  version="1.0"
  xmlns:cis="urn:ietf:params:xml:ns:conference-info-separator"
  xmlns:msmcu="http://schemas.microsoft.com/rtc/2009/03/commonmcuextensions"
  xmlns:tns="http://schemas.microsoft.com/rtc/2005/08/avconfinfoextensions"
  xmlns:xs="http://www.w3.org/2001/XMLSchema">

  <!--
    This import brings in the standard Conference Package Standard Separator
    definitions
  -->
  <xs:import namespace="urn:ietf:params:xml:ns:conference-info-separator"
schemaLocation="ms-ci-separator.xsd" />
  <xs:import namespace="http://schemas.microsoft.com/rtc/2009/03/commonmcuextensions"
schemaLocation="mcucommon.xsd"/>

  <xs:complexType name="capabilities-type">
    <xs:sequence>
      <!--
        The following MSAV settings are actually derived from policy, and appear
        here to reflect

```

a view of "capabilities" that are of interest to some clients. These are read-only.

The effective value can only be changed via policy (entity-policy element of entity-view)

```

-->
  <xs:element name="supports-audio" type="xs:boolean" />
  <xs:element name="supports-video" type="xs:boolean" />
</xs:sequence>
</xs:complexType>
<xs:element name="capabilities" type="tns:capabilities-type" />

<xs:complexType name="audio-settings-type">
  <xs:sequence>
    <xs:any namespace="##any" processContents="lax" minOccurs="0"
maxOccurs="unbounded"/>
  </xs:sequence>
</xs:complexType>
<xs:complexType name="video-settings-type">
  <xs:sequence>
    <xs:any namespace="##any" processContents="lax" minOccurs="0"
maxOccurs="unbounded"/>
  </xs:sequence>
</xs:complexType>

  <xs:complexType name="settings-type">
    <xs:sequence>
      <xs:element name="audio" type="tns:audio-settings-type" minOccurs="0"/>
      <xs:element name="video" type="tns:video-settings-type" minOccurs="0"/>
      <xs:element ref="msmcu:entry-exit-announcements" minOccurs="0"/>
      <xs:sequence minOccurs="0">
        <xs:element ref="cis:separator"/>
        <xs:any namespace="##other" processContents="lax" maxOccurs="unbounded"/>
      </xs:sequence>
    </xs:sequence>
  </xs:complexType>
  <xs:element name="settings" type="tns:settings-type"/>

  <xs:complexType name="contributing-sources-type">
    <xs:sequence>
      <xs:element name="entry" type="xs:anyURI" minOccurs="0" maxOccurs="unbounded"
/>
    </xs:sequence>
    <xs:attribute name="empty" type="xs:boolean" use="optional"/>
  </xs:complexType>

  <xs:complexType name="dominant-speaker-source-type">
    <xs:sequence>
      <xs:element name="entry" type="xs:anyURI" minOccurs="0" />
    </xs:sequence>
  </xs:complexType>

  <xs:element name="video-parameters" type="tns:video-parameters-type"/>
  <xs:complexType name="video-parameters-type">
    <xs:sequence>
      <!--
        The video switching mode. Supported values are "dominant-speaker-switched"
        and "manual-switched"
      -->
      <xs:element name="video-mode" type="xs:string" minOccurs="0" />

      <!-- The desired video source in manual switched mode -->
      <xs:element name="intended-primary-presenter-source" type="tns:contributing-
sources-type" minOccurs="0"/>

      <!-- The intended-secondary-presenter-source is reserved for future use. -->
      <xs:element name="intended-secondary-presenter-source" type="tns:contributing-
sources-type" minOccurs="0"/>

```

```

        <xs:any namespace="##other" processContents="lax" minOccurs="0"
maxOccurs="unbounded" />
    </xs:sequence>
</xs:complexType>

<xs:element name="audio-parameters" type="tns:audio-parameters-type"/>
<xs:complexType name="audio-parameters-type">
    <xs:sequence>
        <xs:any namespace="##other" processContents="lax" minOccurs="0"
maxOccurs="unbounded" />
    </xs:sequence>
</xs:complexType>

<xs:complexType name="state-type">
    <xs:sequence>
        <xs:element name="video-mode" type="xs:string" minOccurs="0"/>
        <xs:element name="dominant-speaker-source" type="tns:dominant-speaker-source-
type" minOccurs="0"/>
        <xs:element name="intended-prime-presenter-source" type="tns:contributing-
sources-type" minOccurs="0" />
        <xs:element name="intended-secondary-presenter-source"
type="tns:contributing-sources-type" minOccurs="0" />
    </xs:sequence>
</xs:complexType>

<xs:element name="audio-video-media-state" type="tns:state-type"/>

<xs:element name="state" type="tns:state-type"/>

<xs:complexType name="endpoint-capabilities-type">
    <xs:sequence>
        <xs:any namespace="##any" processContents="lax" minOccurs="0"
maxOccurs="unbounded"/>
    </xs:sequence>
</xs:complexType>
<xs:element name="endpoint-capabilities" type="tns:endpoint-capabilities-type"/>

<!--
Media Routing Type
Controls Parameters type
Route Parameters type
Wire Parameters type
-->

<xs:complexType name="media-routing-type">
    <xs:sequence>
        <xs:element name="controls" type="tns:controls-parameters-type" minOccurs="0"/>
        <xs:any namespace="##other" processContents="lax" minOccurs="0"
maxOccurs="unbounded" />
    </xs:sequence>
</xs:complexType>

<xs:complexType name="controls-parameters-type">
    <xs:sequence>
        <xs:element name="route" type="tns:route-parameters-type" minOccurs="0"/>
        <xs:any namespace="##other" processContents="lax" minOccurs="0"
maxOccurs="unbounded" />
    </xs:sequence>
</xs:complexType>

<xs:complexType name="route-parameters-type">
    <xs:sequence>
        <xs:element name="wire" type="tns:wire-parameters-type" minOccurs="0"
maxOccurs="unbounded"/>
        <xs:element name="unwire" type="tns:wire-parameters-type" minOccurs="0"
maxOccurs="unbounded"/>
        <xs:any namespace="##other" processContents="lax" minOccurs="0"
maxOccurs="unbounded" />
    </xs:sequence>
</xs:complexType>

```

```

    </xs:sequence>
</xs:complexType>

<xs:complexType name="wire-parameters-type">
  <xs:sequence>
    <xs:element name="filter" type="tns:filter-type" minOccurs="0" maxOccurs="1"/>
    <xs:any namespace="##other" processContents="lax" minOccurs="0"
maxOccurs="unbounded"/>
  </xs:sequence>
  <xs:attribute name="userEntity" type="xs:anyURI" use="required"/>
  <xs:attribute name="endpointEntity" type="xs:string" use="required"/>
  <xs:attribute name="mediaId" type="xs:string" use="required"/>
  <xs:anyAttribute namespace="##other" processContents="lax"/>
</xs:complexType>

<xs:simpleType name="filter-type">
  <xs:restriction base="xs:string">
    <xs:enumeration value="DTMF"/>
  </xs:restriction>
</xs:simpleType>

<xs:element name="type" type="xs:string" />
</xs:schema>

```

6.3.6 imconfinfoextensions Namespace

This namespace is identified by the following URN:

<http://schemas.microsoft.com/rtc/2005/08/imconfinfoextensions>

```

<?xml version="1.0" encoding="utf-8"?>
<xs:schema
targetNamespace="http://schemas.microsoft.com/rtc/2005/08/imconfinfoextensions"
elementFormDefault="qualified" attributeFormDefault="unqualified" version="1.0"
xmlns:tns="http://schemas.microsoft.com/rtc/2005/08/imconfinfoextensions"
xmlns:xs="http://www.w3.org/2001/XMLSchema">
  <xs:complexType name="settings-type">
    <xs:sequence>
      <xs:any namespace="##any" processContents="lax" minOccurs="0"
maxOccurs="unbounded"/></xs:any>
    </xs:sequence>
  </xs:complexType>
  <xs:element name="settings" type="tns:settings-type"/></xs:element>
  <xs:simpleType name="supported-im-formats-type">
    <xs:annotation>
      <xs:documentation>
        A string indicating the im content types that can be rendered by the
endpoint.
      </xs:documentation>
    </xs:annotation>
    <xs:restriction base="xs:string">
      <xs:maxLength value="512"/></xs:maxLength>
    </xs:restriction>
  </xs:simpleType>
  <xs:simpleType name="user-agent-type">
    <xs:annotation>
      <xs:documentation>
        A string indicating the user agent of the endpoint.
      </xs:documentation>
    </xs:annotation>
    <xs:restriction base="xs:string">
      <xs:maxLength value="128"/></xs:maxLength>
    </xs:restriction>
  </xs:simpleType>

```

```

</xs:simpleType>
<xs:complexType name="endpoint-capabilities-type">
  <xs:sequence>
    <xs:element name="supported-im-formats" type="tns:supported-im-formats-type"
minOccurs="0"></xs:element>
    <xs:element name="user-agent" type="tns:user-agent-type"
minOccurs="0"></xs:element>
    <xs:any namespace="##other" processContents="lax" minOccurs="0"
maxOccurs="unbounded"></xs:any>
  </xs:sequence>
</xs:complexType>
<xs:element name="endpoint-capabilities" type="tns:endpoint-capabilities-
type"></xs:element>
</xs:schema>

```

6.3.7 acpconfinfoextensions Namespace

This namespace is identified by the following URN:

<http://schemas.microsoft.com/rtc/2005/08/acpconfinfoextensions>

```

<?xml version="1.0" encoding="utf-8"?>
<xs:schema
targetNamespace="http://schemas.microsoft.com/rtc/2005/08/acpconfinfoextensions"
elementFormDefault="qualified"
attributeFormDefault="unqualified"
version="1.0"
xmlns:ci="urn:ietf:params:xml:ns:conference-info"
xmlns:msci="http://schemas.microsoft.com/rtc/2005/08/confinfoextensions"
xmlns:tns="http://schemas.microsoft.com/rtc/2005/08/acpconfinfoextensions"
xmlns:xs="http://www.w3.org/2001/XMLSchema">

```

```

  <xs:simpleType name="entry-exit-announcement-type">
    <xs:annotation>
      <xs:documentation>
        The different kinds of audio announcement which can
        be played when a user joins or leaves the conference.
      </xs:documentation>
    </xs:annotation>
    <xs:restriction base="xs:string">
      <xs:enumeration value="silence"/>
      <xs:enumeration value="tone"/>
      <xs:enumeration value="recordedName"/>
    </xs:restriction>
  </xs:simpleType>

```

```

  <xs:simpleType name="telephone-number-type">
    <xs:annotation>
      <xs:documentation>
        A telephone number.
      </xs:documentation>
    </xs:annotation>
    <xs:restriction base="xs:string">
      <xs:maxLength value="128"/>
    </xs:restriction>
  </xs:simpleType>

```

```

  <xs:simpleType name="passcode-type">
    <xs:annotation>
      <xs:documentation>
        A passcode for an Audio Conferencing Provider.
      </xs:documentation>
    </xs:annotation>
    <xs:restriction base="xs:string">
      <xs:maxLength value="128"/>
    </xs:restriction>
  </xs:simpleType>

```

```

    </xs:restriction>
  </xs:simpleType>

  <xs:simpleType name="capability-name-type">
    <xs:restriction base="xs:string">
      <xs:enumeration value="dialIn"/>
      <xs:enumeration value="dialOut"/>
      <xs:enumeration value="disconnectUser"/>
      <xs:enumeration value="muteUser"/>
      <xs:enumeration value="joinMuted"/>
      <xs:enumeration value="muteLock"/>
      <xs:enumeration value="lockConference"/>
      <xs:enumeration value="changeEntryExitAnnouncement"/>
      <xs:enumeration value="silenceEntryExitAnnouncement"/>
      <xs:enumeration value="toneEntryExitAnnouncement"/>
      <xs:enumeration value="recordedNameEntryExitAnnouncement"/>
      <xs:enumeration value="recordNames"/>
      <xs:enumeration value="playRecordedName"/>
      <xs:enumeration value="multipleLeaders"/>
      <xs:enumeration value="hashCodeReconciliation"/>
      <xs:enumeration value="activateConference"/>
      <xs:enumeration value="sidebars"/>
      <xs:enumeration value="robotDialInInformation"/>
      <xs:enumeration value="changeUserPstnRole"/>
      <xs:enumeration value="firstPartyDialOut"/>
    </xs:restriction>
  </xs:simpleType>

  <xs:complexType name="capability-type">
    <xs:sequence>
      <xs:any namespace="##other" processContents="lax" minOccurs="0"
maxOccurs="unbounded"/>
    </xs:sequence>
    <xs:attribute name="name" type="tns:capability-name-type" use="required"/>
    <xs:anyAttribute namespace="##other" processContents="lax"/>
  </xs:complexType>

  <xs:complexType name="capabilities-type">
    <xs:sequence>
      <xs:element name="capability" type="tns:capability-type" minOccurs="0"
maxOccurs="unbounded"/>
      <xs:any namespace="##other" processContents="lax" minOccurs="0"
maxOccurs="unbounded"/>
    </xs:sequence>
  </xs:complexType>
  <xs:element name="capabilities" type="tns:capabilities-type"/>

  <xs:complexType name="telephone-numbers-type">
    <xs:sequence>
      <xs:element name="entry" type="tns:telephone-number-type" minOccurs="0"
maxOccurs="unbounded"/>
    </xs:sequence>
  </xs:complexType>

  <xs:complexType name="settings-type">
    <xs:sequence>
      <xs:element name="tollNumber" type="tns:telephone-number-type"
minOccurs="0"/>
      <xs:element name="tollFreeNumber" type="tns:telephone-number-type"
minOccurs="0"/>
      <xs:element name="domain" type="xs:string" minOccurs="0"/>
      <xs:element name="leaderPasscode" type="tns:passcode-type" minOccurs="0"/>
      <xs:element name="participantPasscode" type="tns:passcode-type"/>
      <xs:element name="showTollNumber" type="xs:boolean" minOccurs="0"/>
      <xs:element name="showTollFreeNumber" type="xs:boolean" minOccurs="0"/>
      <xs:element name="enableCallMe" type="xs:boolean" minOccurs="0"/>
      <xs:element name="robotCallerIds" type="tns:telephone-numbers-type"
minOccurs="0"/>
    </xs:sequence>
  </xs:complexType>

```



```

        <xs:any namespace="##other" processContents="lax" minOccurs="0"
maxOccurs="unbounded"/>
    </xs:sequence>
</xs:complexType>
<xs:element name="settings" type="tns:settings-type"/>

<xs:complexType name="state-type">
    <xs:sequence>
        <xs:element name="tollNumber" type="tns:telephone-number-type"
minOccurs="0"/>
        <xs:element name="tollFreeNumber" type="tns:telephone-number-type"
minOccurs="0"/>
        <xs:element name="participantPasscode" type="tns:passcode-type"
minOccurs="0"/>
        <xs:element name="entryExitAnnouncement" type="tns:entry-exit-announcement-
type" minOccurs="0"/>
        <xs:any namespace="##other" processContents="lax" minOccurs="0"
maxOccurs="unbounded"/>
    </xs:sequence>
</xs:complexType>
<xs:element name="state" type="tns:state-type"/>

<xs:complexType name="shared-data-type">
    <xs:sequence>
        <xs:element name="robotDialInPhoneNumber" type="tns:telephone-number-type"
minOccurs="0"/>
        <xs:element name="robotDialInPostDial" type="xs:string" minOccurs="0"/>
        <xs:element name="bridgeUri" type="xs:string" minOccurs="0"/>
        <xs:any namespace="##other" processContents="lax" minOccurs="0"
maxOccurs="unbounded"/>
    </xs:sequence>
</xs:complexType>
<xs:element name="shared-data" type="tns:shared-data-type"/>

<xs:complexType name="endpoint-capabilities-type">
    <xs:sequence>
        <xs:any namespace="##other" processContents="lax" minOccurs="0"
maxOccurs="unbounded"/>
    </xs:sequence>
</xs:complexType>
<xs:element name="endpoint-capabilities" type="tns:endpoint-capabilities-type"/>
</xs:schema>

```

6.3.8 asconfinfoextensions Namespace

This namespace is identified by the following URN:

<http://schemas.microsoft.com/rtc/2005/08/asconfinfoextensions>

```

<?xml version="1.0" encoding="utf-8"?>

<!--Extensions for Application Sharing -->

<xs:schema version="1.0"
targetNamespace="http://schemas.microsoft.com/rtc/2005/08/asconfinfoextensions"
xmlns:tns="http://schemas.microsoft.com/rtc/2005/08/asconfinfoextensions"
xmlns:cis="urn:ietf:params:xml:ns:conference-info-separator"
xmlns:xs="http://www.w3.org/2001/XMLSchema"
xmlns:msmcu="http://schemas.microsoft.com/rtc/2009/03/commonmcuextensions"
elementFormDefault="qualified"
attributeFormDefault="unqualified">

    <!-- This imports the standard separator -->

```

```

    <xs:import namespace="urn:ietf:params:xml:ns:conference-info-separator"
schemaLocation="ms-ci-separator.xsd" />

    <!-- MCU common references-->
    <xs:import namespace="http://schemas.microsoft.com/rtc/2009/03/commonmcuextensions"
schemaLocation="mcucommon.xsd"/>

    <!-- SESSION IDS TYPE -->
    <xs:complexType name="session-ids-type">
        <xs:sequence>
            <xs:element name="session-id" type="xs:string" minOccurs="1"
maxOccurs="unbounded" />
            <xs:any namespace="##other" processContents="lax" minOccurs="0"
maxOccurs="unbounded" />
        </xs:sequence>
    </xs:complexType>
    <xs:element name="session-ids" type="tns:session-ids-type"/>

    <!-- Application Sharing Endpoint capabilities -->
    <xs:element name="media-capabilities" type="tns:media-capabilities-type"/>

    <xs:complexType name="media-capabilities-type">
        <xs:sequence>
            <xs:element name="media-capability" type="msmcu:media-capability-type"
minOccurs="0" maxOccurs="unbounded"/>
            <xs:any namespace="##other" processContents="lax" minOccurs="0"
maxOccurs="unbounded" />
        </xs:sequence>
    </xs:complexType>

    <!-- Application Sharing MCU capabilities -->
    <xs:complexType name="capabilities-type">
        <xs:sequence>
            <xs:element name="supports-application-desktop-sharing" type="tns:supports-
application-desktop-sharing-code-type" />
            <xs:sequence minOccurs="0">
                <xs:element ref="cis:separator"/>
                <xs:any namespace="##other" processContents="lax" maxOccurs="unbounded"/>
            </xs:sequence>
        </xs:sequence>
    </xs:complexType>

    <xs:element name="capabilities" type="tns:capabilities-type"/>

    <xs:simpleType name="supports-application-desktop-sharing-code-type">
        <xs:restriction base="xs:string">
            <xs:enumeration value="none" />
            <xs:enumeration value="singleApplication" />
            <xs:enumeration value="desktop" />
        </xs:restriction>
    </xs:simpleType>

</xs:schema>

```

6.3.9 commonmcuextensions Namespace

This namespace is identified by the following URN:

<http://schemas.microsoft.com/rtc/2009/03/commonmcuextensions>

```

<?xml version="1.0" encoding="utf-8"?>
<!--Extensions for Application Sharing -->
<xs:schema version="1.0"
targetNamespace="http://schemas.microsoft.com/rtc/2009/03/commonmcuextensions"
xmlns:tns="http://schemas.microsoft.com/rtc/2009/03/commonmcuextensions"

```

```

xmlns="http://schemas.microsoft.com/rtc/2009/03/commonmcuextensions"
xmlns:msci="http://schemas.microsoft.com/rtc/2005/08/confinfoextensions"
xmlns:ci="urn:ietf:params:xml:ns:conference-info"
xmlns:cis="urn:ietf:params:xml:ns:conference-info-separator"
xmlns:xs="http://www.w3.org/2001/XMLSchema"
elementFormDefault="qualified"
attributeFormDefault="unqualified"
>

<!-- C3P schema extension for elements common to multiple MCUs -->

<!-- This imports the standard separator -->
<xs:import namespace="urn:ietf:params:xml:ns:conference-info-separator"
schemaLocation="ms-ci-separator.xsd" />

<!--
  This import brings in the MS Conference Package extensions.
-->
<xs:import namespace="http://schemas.microsoft.com/rtc/2005/08/confinfoextensions"
schemaLocation="ms-ci-ext.xsd"/>

<!--
  Sequence of possible capabilities, to be inserted (with
  reference to the capability-value-type type) as they are defined in the
  future. The structure of this XML should look like media-capabilities
  (see ms-ci-ext.xsd)
-->
<xs:complexType name="session-capabilities-type">
  <xs:sequence>
    <xs:any namespace="##any" processContents="lax" minOccurs="0"
maxOccurs="unbounded"/>
  </xs:sequence>
  <xs:anyAttribute namespace="##other" processContents="lax"/>
</xs:complexType>
<xs:element name="session-capabilities" type="tns:session-capabilities-type"/>

<xs:simpleType name="capability-value-type">
  <xs:annotation>
    <xs:documentation>
      Possible capability values (for both endpoint-capabilities and media-
capabilities)
    </xs:documentation>
  </xs:annotation>
  <xs:restriction base="xs:string">
    <xs:enumeration value="sendrecv"/>
    <xs:enumeration value="sendonly"/>
    <xs:enumeration value="recvonly"/>
    <xs:enumeration value="none"/>
  </xs:restriction>
</xs:simpleType>

<xs:complexType name="media-capability-type">
  <xs:sequence>
    <xs:element name="name" type="xs:string"/>
    <xs:element name="value" type="tns:capability-value-type"/>
    <xs:any namespace="##other" processContents="lax" minOccurs="0"
maxOccurs="unbounded"/>
  </xs:sequence>
</xs:complexType>

<!--
  presentation-mode-capable indicates support for role-based restrictions on user
input
-->
<xs:element name="presentation-mode-capable" type="xs:boolean"/>

<!--
  multi-view-capable indicates support for multi-view video
-->

```

```

<xs:element name="multi-view-capable" type="xs:boolean"/>

<!--
    video-presentation-mode-capablee indicates support for role-based restrictions on
    user input for video
-->
<xs:element name="video-presentation-mode-capable" type="xs:boolean"/>

<!--
    PERMISSION OPTIONS TYPE
-->
<xs:element name="permission-options" type="tns:permission-options-type"/>

<xs:complexType name="permission-options-type">
  <xs:sequence>
    <xs:element name="permission-option" type="tns:permission-option-type"
minOccurs="0" maxOccurs="unbounded"/>
    <xs:any namespace="##other" processContents="lax" minOccurs="0"
maxOccurs="unbounded"/>
  </xs:sequence>
  <xs:anyAttribute namespace="##other" processContents="lax"/>
</xs:complexType>

<!--
    PERMISSION OPTION TYPE
-->
<xs:complexType name="permission-option-type">
  <xs:sequence>
    <xs:element name="name" type="xs:string"/>
    <xs:element name="value" type="xs:string"/>
    <xs:element name="mutable" type="xs:boolean"/>
    <xs:any namespace="##other" processContents="lax" minOccurs="0"
maxOccurs="unbounded"/>
  </xs:sequence>
  <xs:anyAttribute namespace="##other" processContents="lax"/>
</xs:complexType>

<!--
    PERMISSIONS TYPE
-->
<xs:element name="permissions" type="tns:permissions-type"/>

<xs:complexType name="permissions-type">
  <xs:sequence>
    <xs:element name="permission-type" type="tns:permission-type" minOccurs="0"
maxOccurs="unbounded"/>
    <xs:any namespace="##other" processContents="lax" minOccurs="0"
maxOccurs="unbounded"/>
  </xs:sequence>
  <xs:anyAttribute namespace="##other" processContents="lax"/>
</xs:complexType>

<!--
    PERMISSION TYPE
-->
<xs:complexType name="permission-type">
  <xs:sequence>
    <xs:element name="name" type="xs:string"/>
    <xs:element name="value" type="xs:string"/>
    <xs:any namespace="##other" processContents="lax" minOccurs="0"
maxOccurs="unbounded"/>
  </xs:sequence>
  <xs:anyAttribute namespace="##other" processContents="lax"/>
</xs:complexType>

<xs:complexType name="entry-exit-announcements-type">
  <xs:sequence>
    <xs:element name="modifiable" type="xs:boolean" minOccurs="0"/>
    <xs:element name="enabled" type="xs:boolean"/>
  </xs:sequence>
</xs:complexType>

```

```
        <xs:any namespace="##other" processContents="lax" minOccurs="0"
maxOccurs="unbounded"/>
    </xs:sequence>
    <xs:anyAttribute namespace="##other" processContents="lax"/>
</xs:complexType>

<xs:element name="entry-exit-announcements" type="tns:entry-exit-announcements-
type"/>

<xs:element name="conf-media-filters-rules" type="msci:media-filters-rules-type" />

<xs:element name="hasWacConnectivity" type="xs:boolean"/>

</xs:schema>
```

Preliminary

7 Appendix B: Product Behavior

The information in this specification is applicable to the following Microsoft products or supplemental software. References to product versions include updates to those products.

- Microsoft Office Communications Server 2007
- Microsoft Office Communications Server 2007 R2
- Microsoft Office Communicator 2007
- Microsoft Office Communicator 2007 R2
- Microsoft Lync Server 2010
- Microsoft Lync 2010
- Microsoft Lync Server 2013
- Microsoft Lync Client 2013/Skype for Business
- Microsoft Skype for Business 2016
- Microsoft Skype for Business Server 2015
- Microsoft Skype for Business 2019 Preview
- Microsoft Skype for Business Server 2019 Preview

Exceptions, if any, are noted in this section. If an update version, service pack or Knowledge Base (KB) number appears with a product name, the behavior changed in that update. The new behavior also applies to subsequent updates unless otherwise specified. If a product edition appears with the product version, behavior is different in that product edition.

Unless otherwise specified, any statement of optional behavior in this specification that is prescribed using the terms "SHOULD" or "SHOULD NOT" implies product behavior in accordance with the SHOULD or SHOULD NOT prescription. Unless otherwise specified, the term "MAY" implies that the product does not follow the prescription.

[<1> Section 2.1](#): Office Communications Server 2007, Office Communicator 2007, Office Communicator 2007 R2, Office Communications Server 2007 R2, Lync 2010, Lync Server 2010: IPv6 is not supported.

[<2> Section 2.2.1.2](#): Office Communications Server 2007, Office Communicator 2007, Office Communications Server 2007 R2, Office Communicator 2007 R2, Lync Server 2010, Lync 2010: This behavior is not supported.

[<3> Section 2.2.1.2](#): Office Communications Server 2007, Office Communicator 2007, Office Communications Server 2007 R2, Office Communicator 2007 R2, Lync Server 2010, Lync 2010: This behavior is not supported.

[<4> Section 2.2.2.1](#): Office Communications Server 2007, Office Communicator 2007, Office Communications Server 2007 R2, Office Communicator 2007 R2, Lync Server 2010, Lync 2010: This behavior is not supported.

[<5> Section 2.2.2.3](#): Office Communications Server 2007, Office Communicator 2007, Office Communications Server 2007 R2, Office Communicator 2007 R2: This behavior is not supported.

[<6> Section 2.2.2.3](#): Office Communications Server 2007, Office Communicator 2007, Office Communications Server 2007 R2, Office Communicator 2007 R2: This behavior is not supported.

[<7> Section 2.2.2.3](#): Office Communications Server 2007, Office Communicator 2007, Office Communications Server 2007 R2, Office Communicator 2007 R2: This behavior is not supported.

[<8> Section 2.2.2.3](#): Office Communications Server 2007, Office Communicator 2007, Office Communications Server 2007 R2, Office Communicator 2007 R2: This behavior is not supported.

[<9> Section 2.2.2.3](#): Office Communications Server 2007, Office Communicator 2007, Office Communications Server 2007 R2, Office Communicator 2007 R2: This behavior is not supported.

[<10> Section 2.2.2.3](#): Office Communications Server 2007, Office Communicator 2007, Office Communications Server 2007 R2, Office Communicator 2007 R2: This behavior is not supported.

[<11> Section 2.2.2.3](#): Office Communications Server 2007, Office Communicator 2007, Office Communications Server 2007 R2, Office Communicator 2007 R2: This behavior is not supported.

[<12> Section 2.2.2.3](#): Office Communications Server 2007, Office Communicator 2007, Office Communications Server 2007 R2, Office Communicator 2007 R2: This behavior is not supported.

[<13> Section 2.2.2.3](#): Office Communications Server 2007, Office Communicator 2007, Office Communications Server 2007 R2, Office Communicator 2007 R2: This behavior is not supported.

[<14> Section 2.2.2.3](#): Office Communications Server 2007, Office Communicator 2007, Office Communications Server 2007 R2, Office Communicator 2007 R2: This behavior is not supported.

[<15> Section 2.2.2.4](#): Office Communications Server 2007, Office Communicator 2007, Office Communications Server 2007 R2, Office Communicator 2007 R2: This behavior is not supported.

[<16> Section 2.2.2.4](#): Office Communications Server 2007, Office Communicator 2007: This behavior is not supported.

[<17> Section 2.2.2.4](#): Office Communications Server 2007, Office Communicator 2007: This behavior is not supported.

[<18> Section 2.2.2.4](#): Office Communications Server 2007, Office Communicator 2007: This behavior is not supported.

[<19> Section 2.2.2.4](#): Office Communications Server 2007, Office Communicator 2007: This behavior is not supported.

[<20> Section 2.2.2.6](#): Office Communications Server 2007, Office Communicator 2007: This behavior is not supported.

[<21> Section 2.2.3.1.2](#): Office Communications Server 2007, Office Communicator 2007, Office Communications Server 2007 R2, Office Communicator 2007 R2, Lync Server 2010, Lync 2010: This behavior is not supported.

[<22> Section 2.2.3.3](#): Office Communications Server 2007, Office Communicator 2007: The **endpoint** element does not contain child elements. All other products can contain a **session-on-behalf-of** element within the **endpoint** element.

[<23> Section 2.2.3.4](#): Office Communications Server 2007, Office Communicator 2007: The **endpoint** element does not contain child elements. All other products can contain a **session-on-behalf-of** element within the **endpoint** element.

[<24> Section 2.2.3.5](#): Office Communications Server 2007, Office Communicator 2007, Office Communications Server 2007 R2, Office Communicator 2007 R2, Lync Server 2010, Lync 2010: This behavior is not supported.

[<25> Section 2.2.3.19](#): Office Communications Server 2007, Office Communicator 2007: This behavior is not supported.

<26> [Section 2.2.3.20](#): Office Communications Server 2007, Office Communicator 2007: This behavior is not supported.

<27> [Section 2.2.3.21](#): Office Communications Server 2007, Office Communicator 2007, Office Communications Server 2007 R2, Office Communicator 2007 R2: This behavior is not supported.

<28> [Section 2.2.3.22](#): Office Communications Server 2007, Office Communicator 2007, Office Communications Server 2007 R2, Office Communicator 2007 R2: This behavior is not supported.

<29> [Section 2.2.4.2](#): Office Communications Server 2007, Office Communicator 2007, Office Communications Server 2007 R2, Office Communicator 2007 R2, Lync Server 2010, Lync 2010: This behavior is not supported.

<30> [Section 2.2.4.2](#): Office Communications Server 2007, Office Communicator 2007, Office Communications Server 2007 R2, Office Communicator 2007 R2, Lync Server 2010, Lync 2010: This behavior is not supported.

<31> [Section 2.2.4.3](#): Office Communications Server 2007, Office Communicator 2007, Office Communications Server 2007 R2, Office Communicator 2007 R2, Lync Server 2010, Lync 2010: This behavior is not supported.

<32> [Section 2.2.6](#): Office Communications Server 2007, Office Communicator 2007, Office Communications Server 2007 R2, Office Communicator 2007 R2: This behavior is not supported.

<33> [Section 2.2.6.1](#): The protocol handler detection APIs are only supported by Windows 8 operating system with Windows Internet Explorer 10.

<34> [Section 2.2.6.3](#): Office Communications Server 2007, Office Communicator 2007, Office Communications Server 2007 R2, Office Communicator 2007 R2, Lync Server 2010, Lync 2010: This behavior is not supported.

<35> [Section 2.2.6.3](#): Office Communications Server 2007, Office Communicator 2007, Office Communications Server 2007 R2, Office Communicator 2007 R2, Lync Server 2010, Lync 2010: This behavior is not supported.

<36> [Section 2.2.6.3](#): Office Communications Server 2007, Office Communicator 2007, Office Communications Server 2007 R2, Office Communicator 2007 R2, Lync Server 2010, Lync 2010: This behavior is not supported.

<37> [Section 2.2.6.3](#): Office Communications Server 2007, Office Communicator 2007, Office Communications Server 2007 R2, Office Communicator 2007 R2, Lync Server 2010, Lync 2010: This behavior is not supported.

<38> [Section 2.2.6.3](#): Office Communications Server 2007, Office Communicator 2007, Office Communications Server 2007 R2, Office Communicator 2007 R2, Lync Server 2010, Lync 2010: This behavior is not supported.

<39> [Section 3.2](#): Office Communications Server 2007, Office Communicator 2007, Office Communications Server 2007 R2, Office Communicator 2007 R2: This behavior is not supported.

<40> [Section 3.2.4.1.1](#): Office Communications Server 2007, Office Communicator 2007: This behavior is not supported. For all other products, the client is required to add a **session-on-behalf-of** element to the **addUser** Request Body.

<41> [Section 3.2.4.2](#): Office Communications Server 2007, Office Communicator 2007: This behavior is not supported. For all other products, if the validation fails, the focus is required to respond with a 403 Forbidden response.

<42> [Section 3.4.4.1](#): Office Communications Server 2007, Office Communicator 2007, Office Communications Server 2007 R2, Office Communicator 2007 R2: This behavior is not supported.

<43> [Section 3.12](#): Office Communications Server 2007, Office Communicator 2007: This behavior is not supported.

<44> [Section 3.14](#): Office Communications Server 2007, Office Communicator 2007, Office Communications Server 2007 R2, Office Communicator 2007 R2: This behavior is not supported.

<45> [Section 3.15](#): Office Communications Server 2007, Office Communicator 2007, Office Communications Server 2007 R2, Office Communicator 2007 R2: This behavior is not supported.

Preliminary

8 Change Tracking

This section identifies changes that were made to this document since the last release. Changes are classified as Major, Minor, or None.

The revision class **Major** means that the technical content in the document was significantly revised. Major changes affect protocol interoperability or implementation. Examples of major changes are:

- A document revision that incorporates changes to interoperability requirements.
- A document revision that captures changes to protocol functionality.

The revision class **Minor** means that the meaning of the technical content was clarified. Minor changes do not affect protocol interoperability or implementation. Examples of minor changes are updates to clarify ambiguity at the sentence, paragraph, or table level.

The revision class **None** means that no new technical changes were introduced. Minor editorial and formatting changes may have been made, but the relevant technical content is identical to the last released version.

The changes made to this document are listed in the following table. For more information, please contact dochelp@microsoft.com.

| Section | Description | Revision class |
|---|--|----------------|
| 2.2.2.3 conference-description Extensions | Added new settings-url optional element to custom-invite type. | Major |
| Z Appendix B: Product Behavior | Updated list of supported products. | major |

9 Index

A

Abstract data model

- [addUser dial-in command](#) 113
- [addUser dial-out command](#) 110
- [common conference control](#) 100
 - [client](#) 100
 - [focus](#) 100
- [conference activation](#) 84
- [conference deactivation](#) 84
- [conference notifications](#) 94
 - [client](#) 94
- [conference subscriptions](#) 94
 - [client](#) 94
- [deleteConference command](#) 108
- [deleteUser command](#) 107
- [endorsing a participant](#) 91
- [getConference command](#) 114
- [join a conference](#) 87
- [leave a conference](#) 87
- [modifyConference command](#) 118
- [modifyConferenceLock command](#) 105
 - [focus](#) 105
- [modifyEndpoint command](#) 116
- [modifyUserRoles command](#) 106
 - [focus](#) 106
- [setLobbyAccess command](#) 116
- [acpconfinfoextensions namespace](#) 230
- [addUser dial-in command](#) 111
 - [abstract data model](#) 113
 - [example](#) 147
 - higher-layer triggered events
 - [client](#) 113
 - [MCU](#) 113
 - [initialization](#) 113
 - [local events](#) 114
 - message processing
 - [client](#) 113
 - [MCU](#) 114
 - [timer events](#) 114
 - [timers](#) 113
- [addUser dial-out command](#) 109
 - [abstract data model](#) 110
 - [example](#) 144
 - high-layer triggered events
 - [MCU](#) 110
 - [initialization](#) 110
 - [local events](#) 111
 - message processing
 - [MCU](#) 111
 - sequencing rules
 - [MCU](#) 111
 - [timer events](#) 111
 - [timers](#) 110
- [Applicability](#) 22
- application/cccp+xml schema
 - [cccp namespace](#) 166
 - [cccpextensions namespace](#) 198
- application/conference-info+xml schema
 - [acpconfinfoextensions namespace](#) 230
 - [asconfinfoextensions namespace](#) 232

- [avconfinfoextensions namespace](#) 226
- [commonmcuextensions namespace](#) 233
- [conference-info namespace](#) 200
- [conference-info-separator namespace](#) 224
- [confinfoextensions namespace](#) 208
- [dataconfinfoextensions namespace](#) 225
- [imconfinfoextensions namespace](#) 229
- application/vnd.microsoft.ocsmeeing document
 - [HTTP request and response](#) 56
 - schema
 - simplejoinconfdoc namespace ([section 6.1.1](#) 164, [section 6.1.2](#) 165, [section 6.1.3](#) 166)
- application/vnd.simplejoinconfdoc namespace ([section 6.1.1](#) 164, [section 6.1.2](#) 165, [section 6.1.3](#) 166)
- [asconfinfoextensions namespace](#) 232
- [avconfinfoextensions namespace](#) 226

C

- [C3P Request and Response Document Formats message](#) 36
 - [addUser dial-in request document](#) 47
 - [addUser dial-in response document](#) 48
 - [addUser dial-out request document](#) 45
 - [addUser dial-out response document](#) 46
 - [addUser request document](#) 39
 - addUser response document ([section 2.2.3.4](#) 40, [section 2.2.3.6](#) 41)
 - [deleteConference request document](#) 45
 - [deleteConference response document](#) 45
 - [deleteUser request document](#) 44
 - [deleteUser response document](#) 44
 - [endorseUser request document](#) 40
 - getConference request document ([section 2.2.3.19](#) 50, [section 3.14](#) 116)
 - [getConference response document](#) 50
 - modifyConference request document ([section 2.2.3.27](#) 52, [section 3.15](#) 118)
 - [modifyConference response document](#) 52
 - [modifyConferenceLock request document](#) 42
 - [modifyConferenceLock response document](#) 43
 - [modifyEndpoint request document](#) 51
 - [modifyEndpoint response document](#) 51
 - [modifyUserRoles request document](#) 41
 - [modifyUserRoles response document](#) 42
 - [requests](#) 36
 - [responses](#) 37
 - [setLobbyAccess request document](#) 50
 - [setLobbyAccess response document](#) 51
- [Capability negotiation](#) 22
- [cccp namespace](#) 166
- [cccpextensions namespace](#) 198
- [Change tracking](#) 241
- [Common conference control](#) 99
 - [abstract data model](#) 100
 - [client](#) 100
 - [focus](#) 100
 - higher-layer triggered events
 - [client](#) 101
 - [focus](#) 101

- initialization
 - [client](#) 101
 - [local events](#) 105
- message processing
 - [client](#) 103
 - [focus](#) 104
- sequencing rules
 - [client](#) 103
 - [focus](#) 104
- timer events
 - [client](#) 105
 - [focus](#) 105
- timers
 - [client](#) 100
- [commonmcuextensions namespace](#) 233
- [Conference activation](#) 84
 - [abstract data model](#) 84
 - [higher-layer triggered events](#) 84
 - [local events](#) 85
 - [message processing](#) 85
 - [sequencing rules](#) 85
 - [timer events](#) 85
- [Conference activation and deactivation – higher-layer triggered events](#) 84
- [Conference activation and deactivation - initialization](#) 84
- [Conference activation and deactivation - timers](#) 84
- [Conference deactivation](#) 84
 - [abstract data model](#) 84
 - [higher-layer triggered events](#) 85
 - [local events](#) 85
 - [message processing](#) 85
 - [sequencing rules](#) 85
 - [timer events](#) 85
- Conference notifications
 - [abstract data model](#) 94
 - [client](#) 94
- higher-layer triggered events
 - [client](#) 95
 - [focus](#) 95
 - [MCU](#) 97
- initialization
 - [client](#) 95
 - [local events](#) 98
- message processing
 - [client](#) 97
 - [focus](#) 98
- sequencing rules
 - [client](#) 97
 - [focus](#) 98
- timer events
 - [client](#) 98
- timers
 - [client](#) 95
- [Conference Roster Document Format message](#) 52
 - [conference-description element](#) 53
 - [conference-view element](#) 55
 - [participant-count attribute](#) 54
 - [user element](#) 53
- [Conference subscriptions](#) 93
 - [abstract data model](#) 94
 - [client](#) 94
 - [example](#) 127
 - [establishing a subscription](#) 127
 - [terminating a subscription](#) 130
- higher-layer triggered events
 - [client](#) 95
 - [focus](#) 95
 - [MCU](#) 97
- initialization
 - [client](#) 95
 - [local events](#) 98
- message processing
 - [client](#) 97
 - [focus](#) 98
- sequencing rules
 - [client](#) 97
 - [focus](#) 98
- timer events
 - [client](#) 98
- timers
 - [client](#) 95
- [conference-info namespace](#) 200
- [conference-info-separator namespace](#) 224
- [confinfoextensions namespace](#) 208

D

- data model - abstract
 - [addUser dial-in command](#) 113
 - [addUser dial-out command](#) 110
 - [common conference control](#) 100
 - [client](#) 100
 - [focus](#) 100
 - [conference activation](#) 84
 - [conference deactivation](#) 84
 - [conference notifications](#) 94
 - [client](#) 94
 - [conference subscriptions](#) 94
 - [client](#) 94
 - [deleteConference command](#) 108
 - [deleteUser command](#) 107
 - [endorsing a participant](#) 91
 - [getConference command](#) 114
 - [join a conference](#) 87
 - [leave a conference](#) 87
 - [modifyConferenceLock command](#) 105
 - [focus](#) 105
 - [modifyUserRoles command](#) 106
 - [focus](#) 106
- [dataconfinfoextensions namespace](#) 225
- [deleteConference command](#) 108
 - [abstract data model](#) 108
 - [example](#) 142
 - [higher-layer triggered events](#) 109
 - [initialization](#) 109
 - [local events](#) 109
 - [message processing](#) 109
 - [sequencing rules](#) 109
 - [timer events](#) 109
 - [timers](#) 109
- [deleteUser command](#) 107
 - [abstract data model](#) 107
 - [example](#) 138
 - [higher-layer triggered events](#) 107
 - [initialization](#) 107
 - [local events](#) 108
- message processing
 - [focus](#) 108
- sequencing rules

[focus](#) 108
[timer events](#) 108
[timers](#) 107

E

[Endorse a participant](#) 90
higher-layer triggered events
[client](#) 91
[focus](#) 92
[message processing](#) 92
[client](#) 92
[focus](#) 92
[sequencing rules](#) 92
[client](#) 92
[focus](#) 92
[timers](#) 91

Endorsing a participant
[abstract data model](#) 91
[initialization](#) 91
[local events](#) 93
[timer events](#) 93

Examples

[addUser dial-in](#) 147
[addUser dial-out](#) 144
[conference subscriptions](#) 127
[establishing a subscription](#) 127
[terminating a subscription](#) 130
[deleteConference](#) 142
[deleteUser](#) 138
[getConference](#) 151
join a conference ([section 4.2](#) 122, [section 4.2.1](#) 122)
[leave a conference](#) 126
[update the dialog](#) 125
[modifyConference](#) 160
[modifyConferenceLock](#) 131
[modifyEndpoint](#) 157
[modifyUserRoles](#) 136
[setLobbyAccess](#) 154
[Simple Join](#) 119

F

[Fields - vendor-extensible](#) 22
[Focus signaling message](#) 23
[conference control](#) 25
[establishment message](#) 24
[header](#) 23
[signaling dialog teardown](#) 24
[signaling dialog update](#) 24
[Focus Subscription Messages message](#) 25
[application/cccp+xml document](#) 35
schema
[cccp namespace](#) 166
[cccpextensions namespace](#) 198
[application/conference-info+xml document](#) 25
[conference-description element](#) 27
[conference-view element](#) 32
[conf-uris element](#) 30
data-mcu-state element ([section 2.2.2.8](#) 33, [section 2.2.2.9](#) 33)
[endpoint element](#) 30
[permission-options element](#) 34
[permissions element](#) 34

[roles element](#) 30
[subscription establishment](#) 25

G

[getConference command](#) 114
[abstract data model](#) 114
[example](#) 151
higher-layer triggered events
[focus](#) 115
[initialization](#) 115
[local events](#) 115
[message processing](#) 115
[sequencing rules](#) 115
[timer events](#) 115
[timers](#) 114
[Glossary](#) 11

H

Higher layer triggered events
addUser dial-out command
[MCU](#) 110
Higher-layer triggered events
addUser dial-in command
[client](#) 113
[MCU](#) 113
common conference control
[client](#) 101
[focus](#) 101
[conference activation](#) 84
[conference deactivation](#) 85
conference notifications
[client](#) 95
[focus](#) 95
[MCU](#) 97
conference subscriptions
[client](#) 95
[focus](#) 95
[MCU](#) 97
[deleteConference command](#) 109
[deleteUser command](#) 107
endorse a participant
[client](#) 91
[focus](#) 92
getConference command
[focus](#) 115
join a conference
[client](#) 87
[focus](#) 88
leave a conference
[client](#) 87
[focus](#) 88
modifyConference command
[MCU](#) 118
[modifyConferenceLock command](#) 106
modifyEndpoint command
[focus](#) 116
[modifyUserRoles command](#) 107
setLobbyAccess command
[focus](#) 117
[Higher-layer triggered events - conference activation and deactivation](#) 84
[HTTP Request and Response message](#) 55
[application/vnd.microsoft.ocsmeeing document](#) 56

- schema
 - simplejoinconfdoc namespace ([section 6.1.1](#) 164, [section 6.1.2](#) 165, [section 6.1.3](#) 166)
 - [HTTP request](#) 55
 - [HTTP response](#) 56
 - [simple join java-script](#) 57

I

- [imconfinfoextensions namespace](#) 229
- [Implementer - security considerations](#) 163
- Implementers
 - [security](#) 163
- [Index of security parameters](#) 163
- [Informative references](#) 15
- Initialization
 - [addUser dial-in command](#) 113
 - [addUser dial-out command](#) 110
 - common conference control
 - [client](#) 101
 - conference notifications
 - [client](#) 95
 - conference subscriptions
 - [client](#) 95
 - [deleteConference command](#) 109
 - [deleteUser command](#) 107
 - [endorsing a participant](#) 91
 - [getConference command](#) 115
 - [join a conference](#) 87
 - [leave a conference](#) 87
 - [modifyConference command](#) 118
 - [modifyConferenceLock command](#) 106
 - [modifyEndpoint command](#) 116
 - [modifyUserRoles command](#) 107
 - [setLobbyAccess command](#) 117
- [Initialization – conference activation and deactivation](#) 84
- Inter-component protocols
 - [browser to join manager](#) 20
 - [client to focus](#) 21
 - [client to focus factory](#) 21
- [Introduction](#) 11

J

- [Join a conference](#) 85
 - [abstract data model](#) 87
 - example ([section 4.2](#) 122, [section 4.2.1](#) 122)
 - [leave a conference](#) 126
 - [update the dialog](#) 125
 - higher-layer triggered events
 - [client](#) 87
 - [focus](#) 88
 - [initialization](#) 87
 - [message processing](#) 89
 - [client](#) 89
 - [focus](#) 89
 - [other local events](#) 90
 - [sequencing rules](#) 89
 - [client](#) 89
 - [focus](#) 89
 - [timer events](#) 90
 - [timers](#) 87

L

- [Leave a conference](#) 85
 - [abstract data model](#) 87
 - higher-layer triggered events
 - [client](#) 87
 - [focus](#) 88
 - [initialization](#) 87
 - [local events](#) 90
 - [message processing](#) 89
 - [client](#) 89
 - [focus](#) 89
 - [sequencing rules](#) 89
 - [client](#) 89
 - [focus](#) 89
 - [timer events](#) 90
 - [timers](#) 87
- Local events
 - [addUser dial-in command](#) 114
 - [addUser dial-out command](#) 111
 - [common conference control](#) 105
 - [conference activation](#) 85
 - [conference deactivation](#) 85
 - [conference notifications](#) 98
 - [conference subscriptions](#) 98
 - [deleteConference command](#) 109
 - [deleteUser command](#) 108
 - [endorsing a participant](#) 93
 - [getConference command](#) 115
 - [joining and leaving a conference](#) 90
 - [modifyConference command](#) 118
 - [modifyConferenceLock command](#) 106
 - [modifyEndpoint command](#) 116
 - [modifyUserRoles command](#) 107
 - [setLobbyAccess command](#) 118

M

- [MCU Conference Roster Document Format message](#) 55
- [Message processing](#) 97
 - addUser dial-in command
 - [client](#) 113
 - [MCU](#) 114
 - addUser dial-out command
 - [MCU](#) 111
 - common conference control
 - [client](#) 103
 - [focus](#) 104
 - [conference activation](#) 85
 - [conference deactivation](#) 85
 - conference notifications
 - [client](#) 97
 - [focus](#) 98
 - conference subscriptions
 - [client](#) 97
 - [focus](#) 98
 - [deleteConference command](#) 109
 - deleteUser command
 - [focus](#) 108
 - [getConference command](#) 115
 - [modifyConferenceLock command](#) 106
 - [modifyEndpoint command](#) 116
 - [modifyUserRoles command](#) 107
 - setLobbyAccess command
 - [focus](#) 117

Messages

- [C3P Request and Response Document Formats](#) 36
 - document
 - [addUser dial-in request](#) 47
 - [addUser dial-in response](#) 48
 - [addUser dial-out request](#) 45
 - [addUser dial-out response](#) 46
 - [addUser request](#) 39
 - [addUser response](#) ([section 2.2.3.4](#) 40, [section 2.2.3.6](#) 41)
 - [deleteConference request](#) 45
 - [deleteConference response](#) 45
 - [deleteUser request](#) 44
 - [deleteUser response](#) 44
 - [endorseUser request](#) 40
 - [getConference request](#) ([section 2.2.3.19](#) 50, [section 3.14](#) 116)
 - [getConference response](#) 50
 - [modifyConference request](#) ([section 2.2.3.27](#) 52, [section 3.15](#) 118)
 - [modifyConference response](#) 52
 - [modifyConferenceLock request](#) 42
 - [modifyConferenceLock response](#) 43
 - [modifyEndpoint request](#) 51
 - [modifyEndpoint response](#) 51
 - [modifyUserRoles request](#) 41
 - [modifyUserRoles response](#) 42
 - [setLobbyAccess request](#) 50
 - [setLobbyAccess response](#) 51
 - [requests](#) 36
 - [responses](#) 37
- [Conference Roster Document Format](#) 52
 - attribute
 - [participant-count](#) 54
 - element
 - [conference-description](#) 53
 - [conference-view](#) 55
 - [user](#) 53
- [focus signaling](#) 23
 - [conference control](#) 25
 - [establishment message](#) 24
 - [header](#) 23
 - [signaling dialog teardown](#) 24
 - [signaling dialog update](#) 24
- [Focus Subscription Messages](#) 25
 - document
 - [application/cccp+xml](#) 35
 - schema
 - [cccp_namespace](#) 166
 - [cccpextensions_namespace](#) 198
 - [application/conference-info+xml](#) 25
 - element
 - [conference-description](#) 27
 - [conference-view](#) 32
 - [conf-uris](#) 30
 - [data-mcu-state](#) ([section 2.2.2.8](#) 33, [section 2.2.2.9](#) 33)
 - [endpoint](#) 30
 - [permission-options](#) 34
 - [permissions](#) 34
 - [roles](#) 30
 - [subscription establishment](#) 25
 - [HTTP Request and Response](#) 55
 - [application/vnd.microsoft.ocsmeeting document](#) 56

- schema
 - [simplejoinconfdoc namespace](#) ([section 6.1.1](#) 164, [section 6.1.2](#) 165, [section 6.1.3](#) 166)
 - [HTTP request](#) 55
 - [HTTP response](#) 56
 - [simple join java-script](#) 57
- [MCU Conference Roster Document Format](#) 55
 - [syntax](#) 23
 - [transport](#) 23
 - [HTTP](#) 23
 - [SIP](#) 23
- modifyConference command
 - [abstract data model](#) 118
 - [example](#) 160
 - higher-layer triggered events
 - [MCU](#) 118
 - [initialization](#) 118
 - [local events](#) 118
 - [timer events](#) 118
 - [timers](#) 118
- [modifyConferenceLock command](#) 105
 - [abstract data model](#) 105
 - [focus](#) 105
 - [example](#) 131
 - higher-layer triggered events 106
 - [initialization](#) 106
 - [local events](#) 106
 - [message processing](#) 106
 - [sequencing rules](#) 106
 - [timer events](#) 106
 - [timers](#) 106
- [modifyEndpoint command](#) 115
 - [abstract data model](#) 116
 - [example](#) 157
 - higher-layer triggered events
 - [focus](#) 116
 - [initialization](#) 116
 - [local events](#) 116
 - [message processing](#) 116
 - [sequencing rules](#) 116
 - [timer events](#) 116
 - [timers](#) 116
- [modifyUserRoles command](#) 106
 - [abstract data model](#) 106
 - [focus](#) 106
 - [example](#) 136
 - higher-layer triggered events 107
 - [Initialization](#) 107
 - [local events](#) 107
 - [message processing](#) 107
 - [sequencing rules](#) 107
 - [timer events](#) 107
 - [timers](#) 107

N

- Namespace
 - [acpconfinfoextensions](#) 230
 - [asconfinfoextensions](#) 232
 - [avconfinfoextensions](#) 226
 - [cccp](#) 166
 - [cccpextensions](#) 198
 - [commonmcuextensions](#) 233
 - [conference-info](#) 200
 - [conference-info-separator](#) 224

- [confinfoextensions](#) 208
- [dataconfinfoextensions](#) 225
- [imconfinfoextensions](#) 229
- simplejoinconfdoc ([section 6.1.1](#) 164, [section 6.1.2](#) 165, [section 6.1.3](#) 166)
- [Normative references](#) 14
- Notifications
 - [conference](#) 93
 - abstract data model
 - [client](#) 94

O

- Overview (synopsis)
 - [architecture](#) 16
 - [background](#) 16
 - [end-to-end call flow](#) 18
 - [inter-component protocols](#) 20
 - [browser to join manager](#) 20
 - [client to focus](#) 21
 - [client to focus factory](#) 21
 - [scope](#) 21

P

- [Parameters - security index](#) 163
- [Preconditions](#) 21
- [Prerequisites](#) 21
- [Product behavior](#) 237

R

- [References](#) 14
 - [informative](#) 15
 - [normative](#) 14
- [Relationship to other protocols](#) 21

S

- Schema
 - application/cccp+xml schema
 - [cccp namespace](#) 166
 - [cccpextensions namespace](#) 198
 - application/conference-info+xml schema
 - [acpconfinfoextensions namespace](#) 230
 - [asconfinfoextensions namespace](#) 232
 - [ayconfinfoextensions namespace](#) 226
 - [commonmcuextensions namespace](#) 233
 - [conference-info namespace](#) 200
 - [conference-info-separator namespace](#) 224
 - [confinfoextensions namespace](#) 208
 - [dataconfinfoextensions namespace](#) 225
 - [imconfinfoextensions namespace](#) 229
 - application/vnd.microsoft.ocsmeeeting document
 - simplejoinconfdoc namespace ([section 6.1.1](#) 164, [section 6.1.2](#) 165, [section 6.1.3](#) 166)

Security

- [implementer considerations](#) 163
- [implementers](#) 163
- [parameter index](#) 163

Sequencing rules

- addUser dial-in command
 - [client](#) 113
 - [MCU](#) 114
- addUser dial-out command

- [MCU](#) 111
- common conference control
 - [client](#) 103
 - [focus](#) 104
 - [conference activation](#) 85
 - [conference deactivation](#) 85
- conference notifications
 - [client](#) 97
 - [focus](#) 98
- conference subscriptions
 - [client](#) 97
 - [focus](#) 98
- [deleteConference command](#) 109
- deleteUser command
 - [focus](#) 108
- [getConference command](#) 115
- [modifyConferenceLock command](#) 106
- [modifyEndpoint command](#) 116
- [modifyUserRoles command](#) 107
- setLobbyAccess command
 - [focus](#) 117
- setLobbyAccess command
 - [abstract data model](#) 116
 - [example](#) 154
- higher-layer triggered events
 - [focus](#) 117
- [initialization](#) 117
- [local events](#) 118
- message processing
 - [focus](#) 117
- sequencing rules
 - [focus](#) 117
- [timer events](#) 118
- [timers](#) 116
- Simple join
 - [example](#) 119
 - [HTTP request and response](#) 57
- [Standards assignments](#) 22
- Subscriptions
 - [conference](#) 93
 - abstract data model
 - [client](#) 94
- [Syntax](#) 23

T

- Timer events
 - [addUser dial-in command](#) 114
 - [addUser dial-out command](#) 111
- common conference control
 - [client](#) 105
 - [focus](#) 105
 - [conference activation](#) 85
 - [conference deactivation](#) 85
- conference notifications
 - [client](#) 98
- conference subscriptions
 - [client](#) 98
- [deleteConference command](#) 109
- [deleteUser command](#) 108
- [endorsing a participant](#) 93
- [getConference command](#) 115
- [join a conference](#) 90
- [leave a conference](#) 90
- [modifyConference command](#) 118

- [modifyConferenceLock command](#) 106
- [modifyEndpoint command](#) 116
- [modifyUserRoles command](#) 107
- [setLobbyAccess command](#) 118
- Timers
 - [addUser dial-in command](#) 113
 - [addUser dial-out command](#) 110
 - common conference control
 - [client](#) 100
 - conference notifications
 - [client](#) 95
 - conference subscriptions
 - [client](#) 95
 - [deleteConference command](#) 109
 - [deleteUser command](#) 107
 - [endorse a participant](#) 91
 - [getConference command](#) 114
 - [join a conference](#) 87
 - [leave a conference](#) 87
 - [modifyConference command](#) 118
 - [modifyConferenceLock command](#) 106
 - [modifyEndpoint command](#) 116
 - [modifyUserRoles command](#) 107
 - [setLobbyAccess command](#) 116
- [Timers – conference activation and deactivation](#) 84
- [Tracking changes](#) 241
- [Transport](#) 23
 - [HTTP messages](#) 23
 - [SIP messages](#) 23
- Triggered events
 - addUser dial-in command
 - [client](#) 113
 - [MCU](#) 113
 - addUser dial-out command
 - [MCU](#) 110
 - common conference control
 - [client](#) 101
 - [focus](#) 101
 - [conference activation](#) 84
 - [conference deactivation](#) 85
 - conference notifications
 - [client](#) 95
 - [focus](#) 95
 - [MCU](#) 97
 - conference subscriptions
 - [client](#) 95
 - [focus](#) 95
 - [MCU](#) 97
 - [deleteConference command](#) 109
 - [deleteUser command](#) 107
 - endorse a participant
 - [client](#) 91
 - [focus](#) 92
 - getConference command
 - [focus](#) 115
 - join a conference
 - [client](#) 87
 - [focus](#) 88
 - leave a conference
 - [client](#) 87
 - [focus](#) 88
 - modifyConference command
 - [MCU](#) 118
 - [modifyConferenceLock command](#) 106
 - modifyEndpoint command
 - [focus](#) 116
 - [modifyUserRoles command](#) 107
 - setLobbyAccess command
 - [focus](#) 117
 - [Triggered events - conference activation and deactivation](#) 84

V

- [Vendor-extensible fields](#) 22
- [Versioning](#) 22